



**lucifero's**  
ARCHI-TECH LIGHTING

**lucifero's**  
ARCHI-TECH LIGHTING



# INDICE • INDEX

## PROFILI E SISTEMI • PROFILES & SYSTEMS • PERFILES & SISTEMAS **RANGE** p.30

### LBS p.32



### LEVA p.54

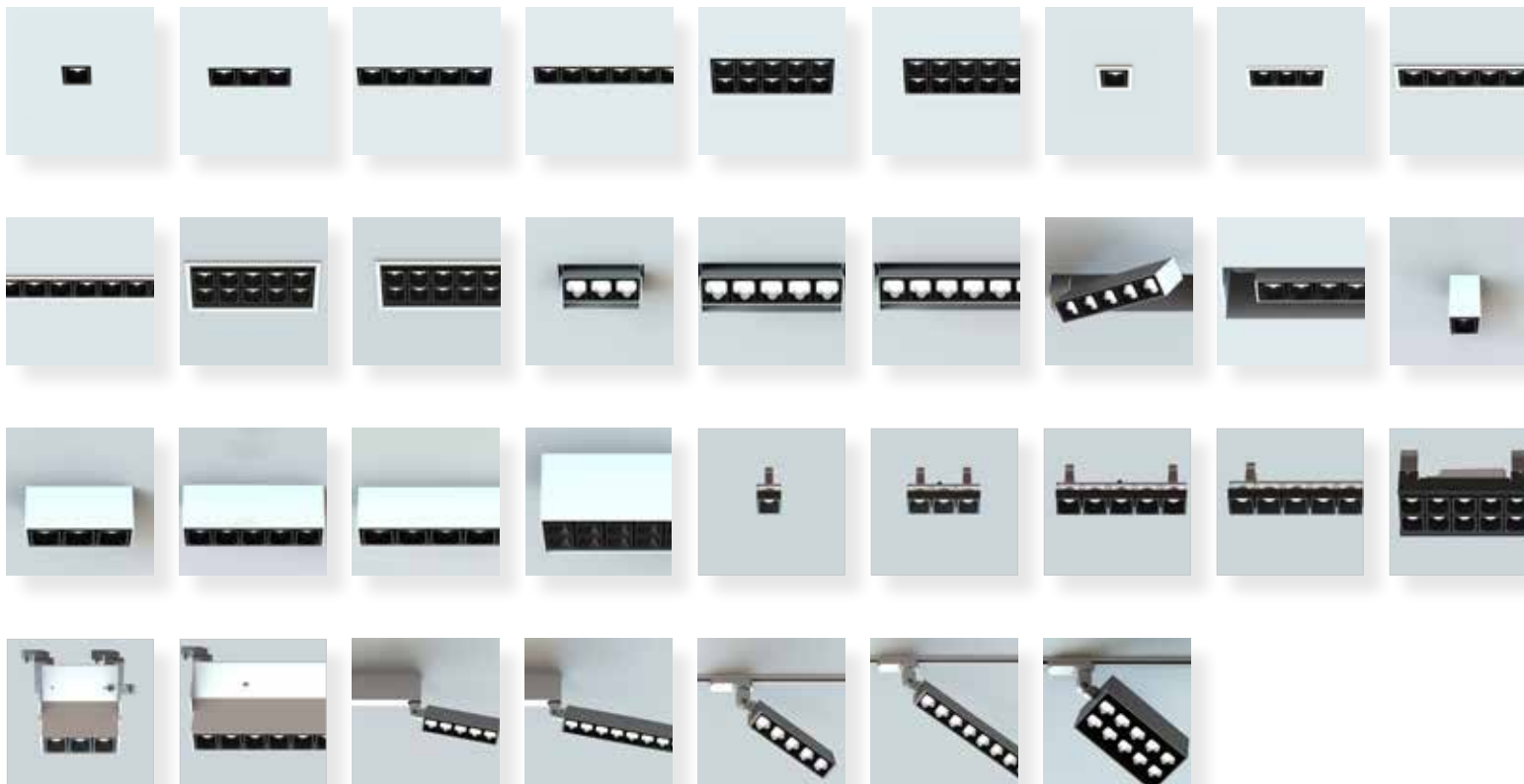

### FARETÈN p.90



**MICROFILE p.106**



**MINIFILE p.122**



**MINIFILE OPENLIGHT p.158**



**FILE p.170**



**FILE H p.214**



**FILE 2 p.234**



**FILE 2 COMPLEMENTI p.306**



**FILE 2H p.310**



**CONTAINER p.334**



**FLIK FLOK p.360**



**SEGMENT p.372**



**GUIDE p.398**



# INCASSI · DOWNLIGHTERS · EMPOTRADO RANGE p.416

CI p.418



NYX p.426

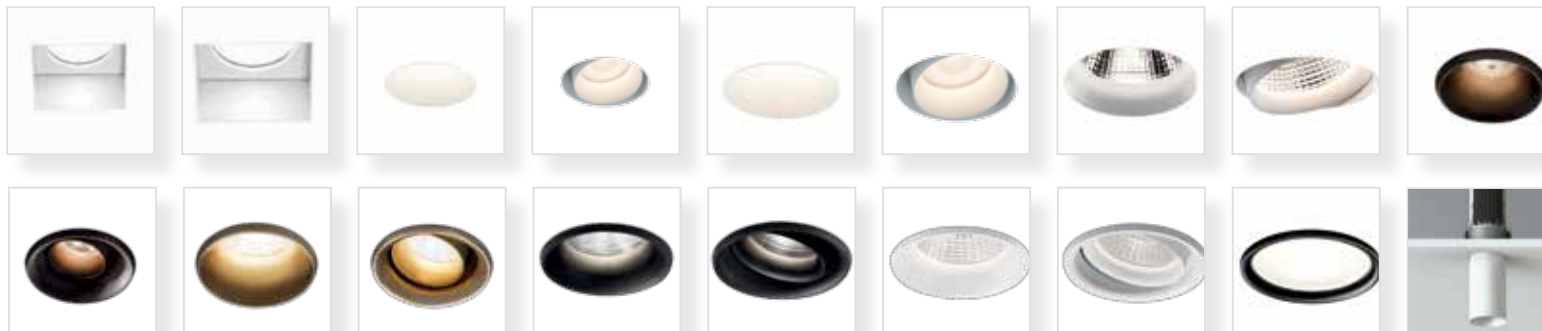

TWENTY7 p.456



LIGHT DRUM p.486



MOVE p.488



INCAS SPOT & DIFFUSED p.506



MINI INCAS p.524

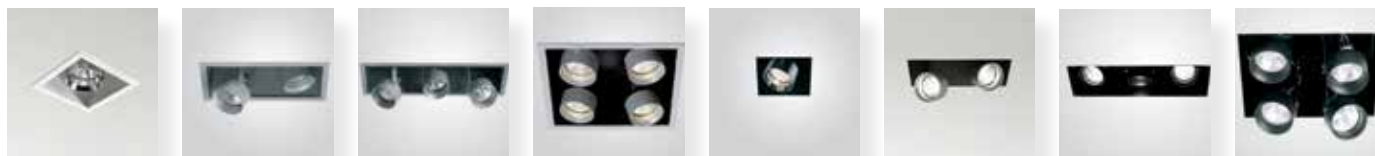

MINIFRAME p.538



HIDE SYSTEM p.544



INCAS 45-90 p.552



STEP p.558



WINDOW p.564



# PROIETTORI • PROJECTORS • PROYECTORES RANGE p.574

SEMPLICE p.576



PHAR p.592



PRO IN p.604

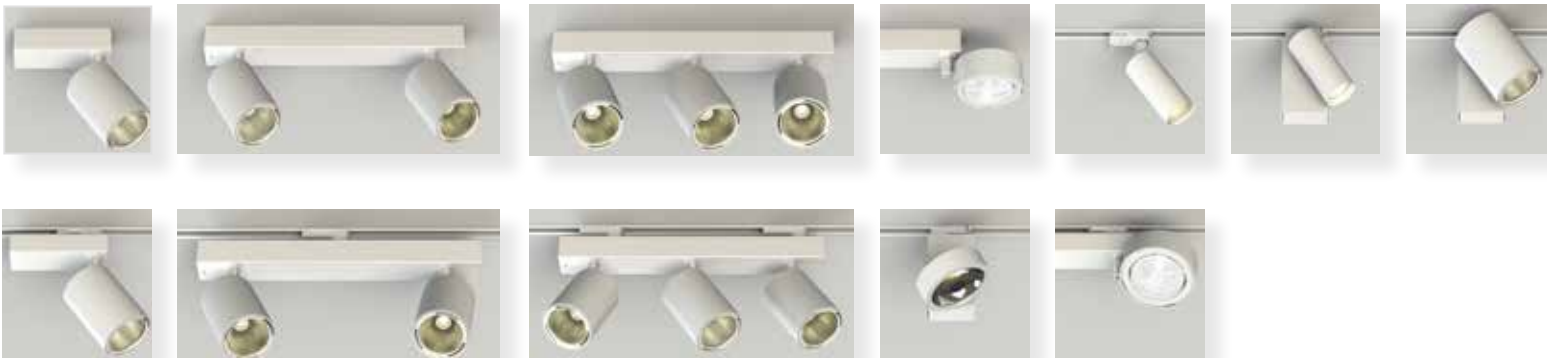

BI-CUBO p.616



EXTENSOR p.624



MINIFILE OPENLIGHT TRACK p.632



FILE 2 TRACK p.638



TRACKS p.644



# WALL CEILING & FLOOR LIGHTING RANGE p.654

iCEMENTI p.656



iPIEDI p.670



FILE 2 COMPLEMENTI p.692



MANINE p.696



APP-LIQUES p.704



RIGO p.708



SCENA p.716



STRUTTURA p.724



## OUTDOOR RANGE p.732

### iCEMENTI p.736



### MANINE p. 748



### FLIK FLOK p.54



### iPIEDI p.758



### IN-OUT p.766



### FILE 2 p.772



### MICROFILE p.776



### FORMAT p.782



### STEP p.788



### PIEDINI p.794



---

**VINTAGE RANGE** p.800

ATLAS p.802



ORION p.804



FLOW p.808



MIMOS p.812



PLANET p.814



HARIO p.816



---

**APPENDIX** p.818





**“La luce è proprio tutto: sogno, sentimento, stile,  
colore, tono, profondità, atmosfera, vibrazione,  
racconto, ideologia”**

F. Fellini

**"SHAPING YOUR IDEAS  
WITH THE ITALIAN TOUCH"**



# Lucifero's

ARCHI-TECH LIGHTING

Dal 1978 coniughiamo creatività, innovazione e curiosità ad avanguardia tecnologica e affidabilità nel tempo. La nostra forza deriva dall'amore per questo splendido mestiere, per i materiali e per il saper fare, che viene dall'esperienza accumulata in tanti anni, e dalla consapevolezza che un'azienda che funziona si basa su un team di persone affiatate, che vivono il proprio lavoro come una passione, prima ancora che come una necessità.

Lavoriamo in tutto il mondo, i nostri prodotti, standard o su misura, vengono inseriti nei progetti più diversi, catene di negozi, università, centri commerciali, uffici, musei e abitazioni private.

Il *Made in Italy* fa parte della nostra cultura. *Made in Italy* è il nostro marchio di fabbrica. I nostri prodotti non sono solo assemblati, ma concepiti e prodotti in Italia.

Since 1978 we have combined creativity, innovation and curiosity with advanced technology and reliability. Our strength is rooted in our love for this wonderful profession, for the materials, for the know-how that comes from experience accumulated over many years, and from the understanding that a successful company is based on a close-knit team of people, who experience their work more as a passion than a necessity.

We work worldwide. Our products, standard or customised, are included in a wide range of different projects, such as chain stores, universities, shopping centres, offices, museums and private homes.

*Made in Italy* is part of our culture. *Made in Italy* is our trademark. Our products are designed and manufactured as well as assembled in Italy.



**light-bound since 1978**

passion - competence - creativity

1978

made in Italy is our culture.  
made in Italy is a trademark that we are so proud of.  
our products are made in Italy...  
watch out: not assembled but MADE in Italy

made in Italy

## ALTA RESA CROMATICA

L'Indice di Resa Cromatica (CRI Color Rendering Index) è una misura quantitativa che indica la capacità di una sorgente luminosa di saturare fedelmente i colori degli oggetti: più il valore è alto, più l'occhio umano li percepisce nella loro reale natura cromatica. Lucifero's per i suoi prodotti utilizza led COB (Chip On Board) con CRI>90 per qualsiasi temperatura colore. L'attenta selezione dei LED utilizzati garantisce eccellenti tonalità cromatiche e un'uniformità del colore costante nel tempo: tutti i LED hanno un valore SDCM <3, caratteristica che impedisce all'occhio umano di percepire la benché minima variazione di colore del LED stesso.

The Colour Rendering Index (CRI) is a quantitative measure of the ability of a light source to faithfully saturate the colours of objects. The higher the value, the more the human eye perceives them in their real colour nature. Lucifero's products use LED COB (Chip On Board) with CRI>90 for any colour temperature. We carefully select the LEDs used to ensure excellent colour tones and reliably consistent colour uniformity. All the LEDs we use have Step MacAdam (SDMC) <3 to avoid any visible colour difference between two or more colours.



## HIGH COLOUR RENDERING





Lucifero's seleziona i LED stabilendo rigorosi parametri di flusso luminoso, efficienza luminosa, resa cromatica e punto colore. Nel caso di piastre multiled, la disposizione dei diodi viene decisa in funzione del corpo illuminante e delle lenti utilizzate. Lucifero's progetta e sviluppa i differenti master indicando i precisi punti di connessione e quelli di posizionamento delle ottiche secondarie, considerando anche il corretto deflusso del calore dalla piastra attraverso il dissipatore ed il corpo illuminante.

Lucifero's selects the LEDs, setting strict parameters of luminous flux, luminous efficiency, colour rendering and colour point. In the case of multiLED plates, we arrange the diodes in relation to the lighting unit and the lenses used. Lucifero's designs and develops different masters indicating the specific connection points and the positioning points of the secondary optics, also taking account of the correct flow of heat from the plate through the heat sink and the lighting unit.



# A R C H I

---

Nell'ideare la veste degli apparecchi d'illuminazione il nostro riferimento è il linguaggio dell'architettura, mentre nello sviluppare le caratteristiche tecniche dei "motori" di cui li dotiamo abbiamo particolare attenzione soprattutto alle necessità tecniche del lighting design. Siamo infatti convinti che un prodotto architettonico curato nei dettagli estetici debba presentare una tecnologia avanzata e, viceversa, che un prodotto tecnico debba avere anche una sua eleganza estetica.

**ARCHI-TECH LIGHTING** è l'espressione di questa filosofia creativa e produttiva.

We use the language of architecture as our reference when designing the appearance of lighting devices, but in the technical design of the "motors" we focus our attention on the technical demands of lighting design. Indeed, we believe that an architectural product that pays attention to aesthetic detail should be equipped with advanced technology and, conversely, that a technical product should also have its own aesthetic elegance.

**ARCHI-TECH LIGHTING** is an expression of this creative and productive philosophy.



T

E

C

H



T

I

N

G



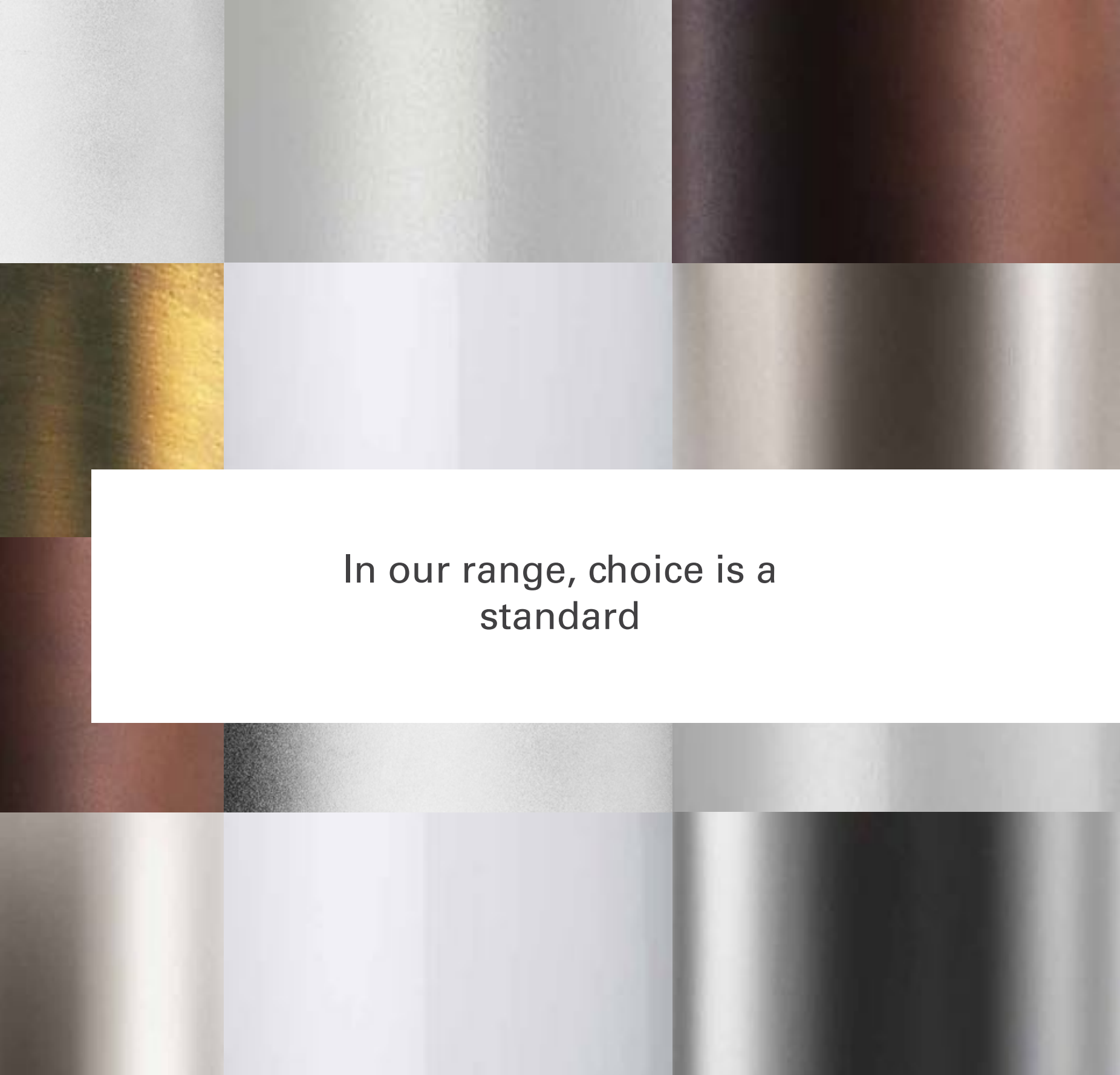

In our range, choice is a  
standard

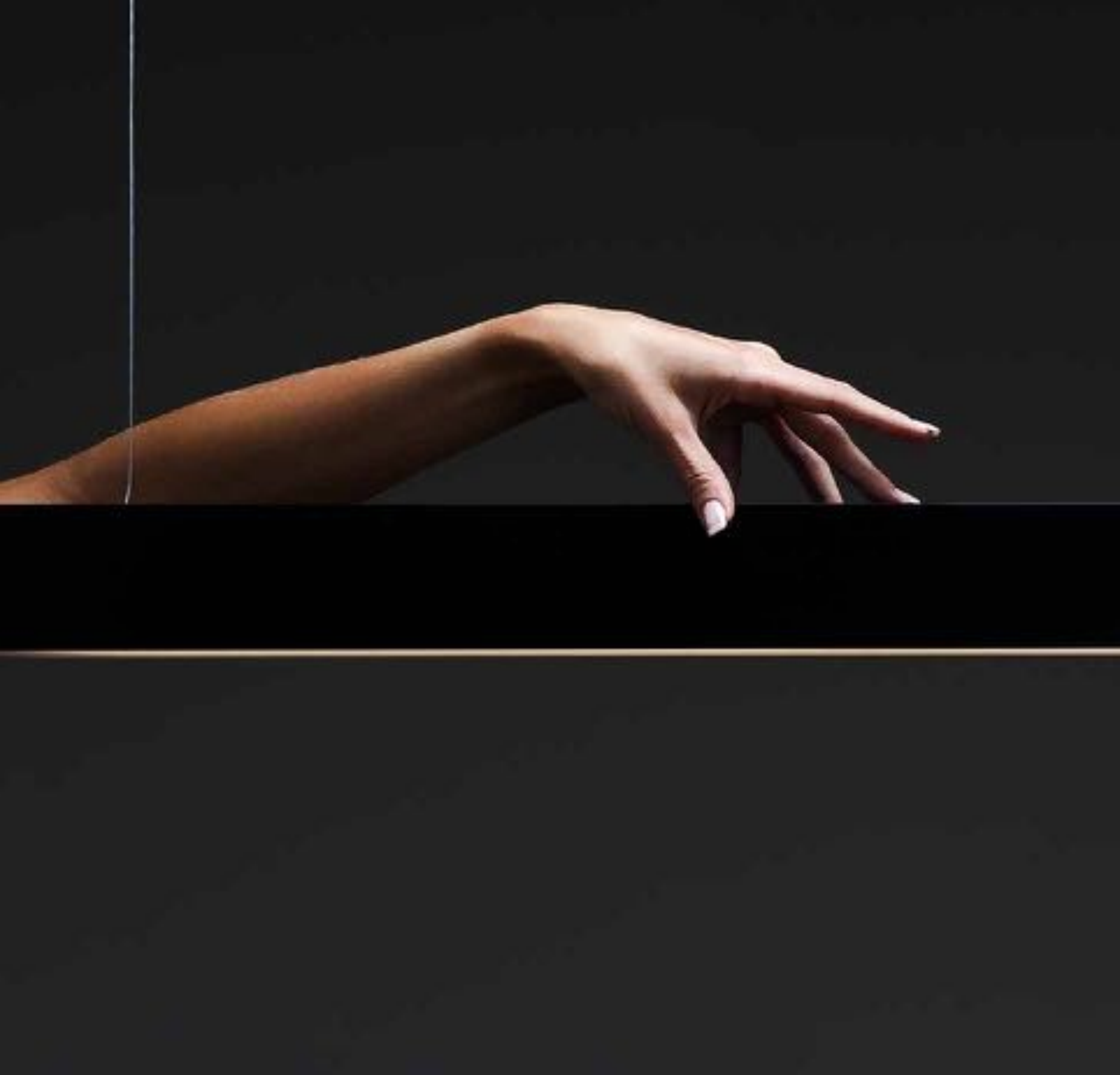

have it as long as your project requires. flexibility means Lucifero's

---



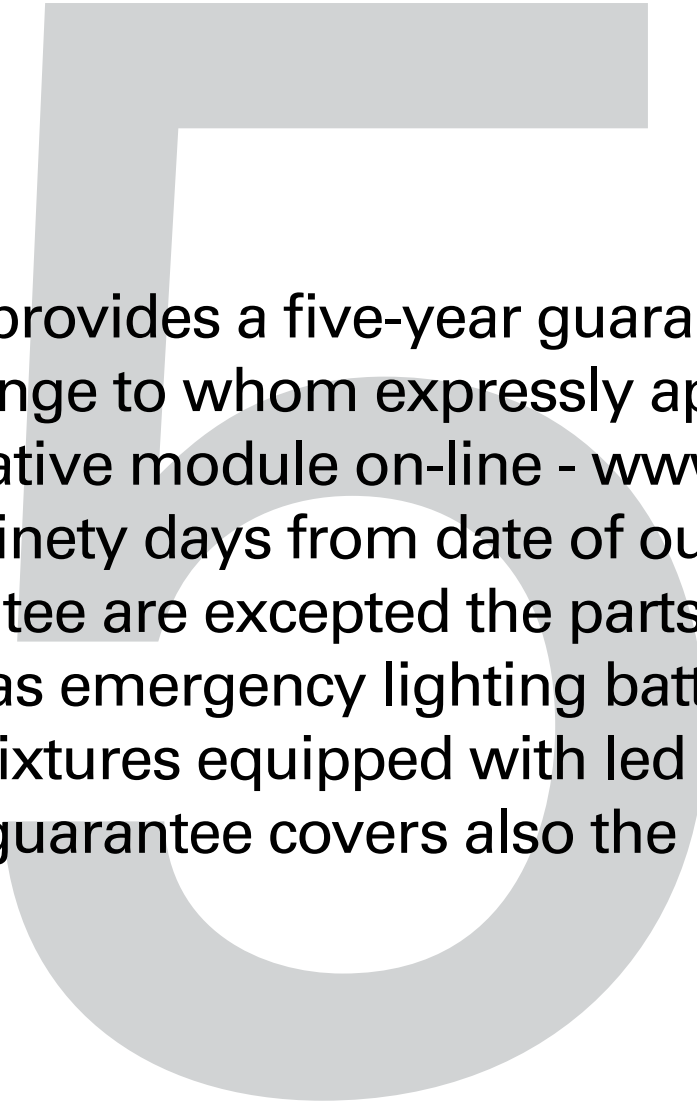

Lucifero's provides a five-year guarantee for its product-range to whom expressly applies for it filling-in the relative module on-line - [www.luciferos.com](http://www.luciferos.com) - within ninety days from date of our invoice. From the guarantee are excepted the parts subject to wear, such as emergency lighting batteries. Within fixtures equipped with led sources the guarantee covers also the leds.

years guaranteed



# "MORE LUCIFERO'S"

## ONLINE CATALOGUE

Oltre ai cataloghi in versione cartacea, Lucifero's mette a disposizione degli utenti il sito web [www.luciferos.com](http://www.luciferos.com), all'interno del quale è possibile non solo visionare tutte le nostre collezioni prodotti, ma anche scaricare il relativo materiale tecnico, quali schede di capitolato, istruzioni di montaggio, dati fotometrici, etc., accedere alle novità e iniziative più recenti intraprese dall'azienda, vedere le immagini di alcuni dei progetti più prestigiosi ed utilizzare l'utilissimo Configuratore di Profili. Considerata la rapidità di aggiornamento tecnologico delle sorgenti LED, consigliamo di accedere al nostro web site con frequenza, in quanto è possibile che questo riporti informazioni più aggiornate di quelle reperibili sui cataloghi cartacee.

In addition to the hard copies of our catalogues, you can access our web site [www.luciferos.com](http://www.luciferos.com), within which, beyond viewing our products ranges, you can also download the relative technical information, such as the specification sheets, the mounting instructions, the photometric data, etc., access to the latest news and initiatives undertaken by our company, see the images of some of our most prestigious installations and use our useful Profile Configurator. Given the pace of LEDs' technical data update, we suggest to visit our web site frequently, since it is possible that it reports information more updated than that available in the catalogues' hard copies.

## CONFIGURATOR





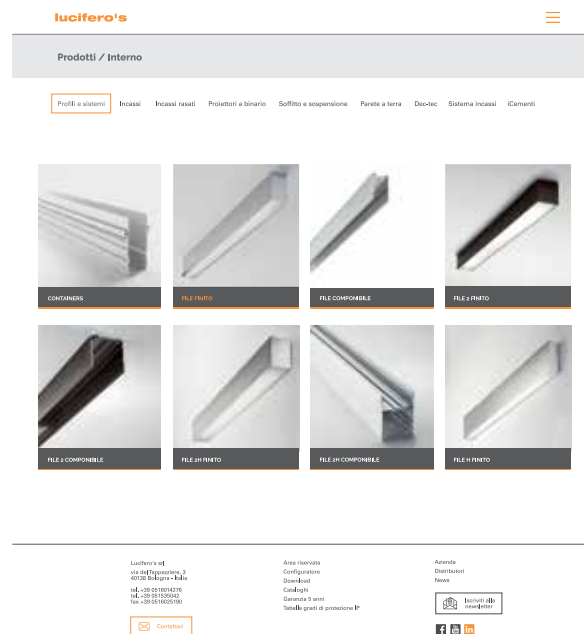





Sul nostro web site [www.luciferos.com](http://www.luciferos.com) è presente un utilissimo tool di progettazione – il Configuratore di Profili – che in pochi e intuitivi click vi permette di scaricare in formato PDF la lista dei codici e quantità necessarie a comporre la configurazione del profilo da voi scelto all'interno della nostre collezioni.

On [www.luciferos.com](http://www.luciferos.com) you can access a very useful project tool – the Profile Configurator – that in a few and easy clicks allows you to download in PDF format the ref. codes and quantity list necessary to create the configuration of the profile chosen within our product range.



Codici prodotto    Applicazioni    Prodotti correlati

Filtra per:

Tipologia	Codice	Colore	Descrizione	Dimensioni	Download
	LTC04	01	1x12,8W 230V Finiar LED lx 25°C 170lmh 3000K	L 980 mm	
	LTC04	01	1x12,8W 230V Finiar LED lx 25°C 170lmh 3000K	L 980 mm	
	LTC04	01	1x12,8W 230V Finiar LED lx 25°C 170lmh 3000K	L 980 mm	
	LTC04	01	1x12,8W 230V Finiar LED lx 25°C 170lmh 3000K	L 980 mm	
	LTC04	01	1x12,8W 230V Finiar LED lx 25°C 170lmh 3000K	L 980 mm	
	LTC04	01	1x12,8W 230V Finiar LED lx 25°C 170lmh 3000K	L 980 mm	
	LTC04	01	1x12,8W 230V Finiar LED lx 25°C 170lmh 3000K	L 980 mm	
	LTC04	01	1x12,8W 230V Finiar LED lx 25°C 170lmh 3000K	L 980 mm	

Each row in the table includes a 'Download' icon and a small 'LED con driver' label next to the profile image.

## DESIGN SUPPORT

In Lucifero's è presente un team di progettisti illuminotecnici in grado di supportarvi nelle vostre scelte progettuali in materia di apparecchi di illuminazione. Inviandoci le piante dei vostri progetti avremo modo di consigliarvi sul tipo di illuminazione più appropriata alle vostre esigenze e sulla tipologia e numero di apparecchi di illuminazione necessari e compatibili al budget a vostra disposizione, corredando le nostre proposte con calcoli fotometrici professionali.

We at Lucifero's want to follow you also in the design stage of your lighting. An in-house team of professional lighting designers is here to support you in your design choices. Sending us your plans, we will be able to advise you regarding the type of lighting that best fits your requirement and the type and quantity of lighting fittings necessary and compatible with your budget, providing our proposal with professional lighting calculations.

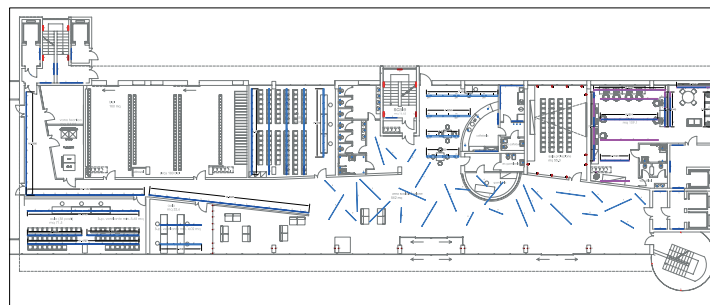

## Lucifero's SPECIAL

Oltre al presente catalogo generale. Lucifero's mette a disposizione una serie di brochure aggiuntive, che hanno lo scopo di presentare con maggior dettaglio famiglie di prodotti già presenti in questo catalogo o di presentare novità prodotti alla loro prima uscita.

In addition to the present general catalogue, Lucifero's makes available a series of additional products brochures, with the aim of presenting more in depth specific product families or of introducing new products at their first show.



## **"FD - FAST DELIVERY"**

All'interno della collezione Lucifero's una serie di articoli è spedibile in circa 7 giorni lavorativi dalla conferma d'ordine, compatibilmente con le scorte di magazzino e gli ordini già in corso presenti al momento dell'ordine.

Questi articoli sono evidenziati in colore **rosso** nei nostri listini prezzi al pubblico.

Within Lucifero's range some products can be shipped in about 7 working days from our order confirmation, according to our stocks and on-going orders at the moment of the order.

These products are indicated in **red** colour on our current public pricelists.

FED

## PROFILI E SISTEMI • PROFILES & SYSTEMS • PERFILES & SISTEMAS **RANGE**

LBS p.32



LEVA p.54

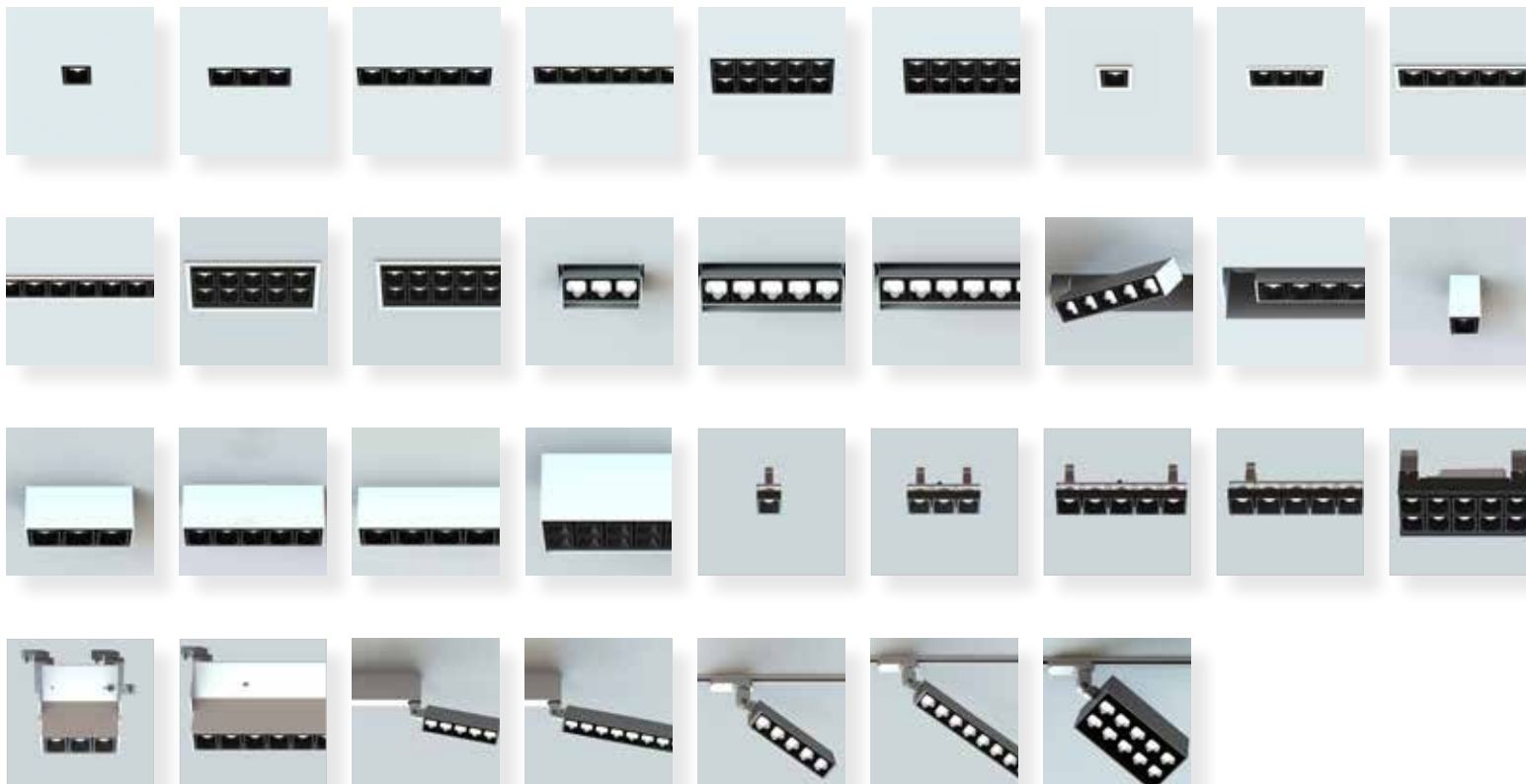

FARETÈN p.90



MICROFILE pag. 106



MINIFILE pag. 122



MINIFILE OPENLIGHT pag. 158



FILE pag. 170



FILE H pag. 214



FILE 2 pag. 234



FILE 2 COMPLEMENTI pag. 300



FILE 2H pag.310



CONTAINER pg.336



FLIK FLOK pag.360



SEGMENT pag.372



GUIDE pag.400



LBS è un nastro di profilo di alluminio estruso molto sottile, che può essere installato a plafone, a sospensione, a parete e a incasso. Composto da moduli base, a seconda di come questi vengono assemblati, può assumere la forma di un arco (per essere installato a parete), di un cerchio (per formare sospensioni, plafoni e incassi trimless) o di una linea sinuosa (per formare un sistema che si snoda lungo il soffitto). L'estruso che ne costituisce il corpo è disegnato in modo tale da poter ospitare la sorgente LED lineare, schermata da un diffusore bianco opalino, sia sul lato verticale interno – e quindi emettere la luce sull'asse orizzontale - sia sul lato orizzontale, più stretto - e quindi emettere la luce sull'asse verticale (indiretta). Nell'impiego a plafone, incasso e sospensione è disponibile, inoltre, con emissione diffusa verso il basso. LBS, infine, permette anche di impiegare proiettori per luce orientata e d'accento, aggiuntivi rispetto allo stesso, che possono essere agganciati e alimentati elettricamente.

LBS is a thin band of extruded aluminium section and it is possible to install it in many different ways. It consists of basic modules and, depending on the way they are assembled, it can be arch shaped (to be installed on a wall), circular shaped (to create swinging, ceiling and trimless recessed fixtures) or it may have a curving shape (to form a band which twists and turns on the ceiling, for instance). The extruded part, representing its body, is drawn in such a way to be able to house the linear LED light source, shaded with a white opal diffuser, both on the inside vertical side and therefore to give out light on its horizontal axis, and on its narrower and horizontal side and consequently to give out light on its vertical axis (indirect one). It is also available in ceiling, pendant and trimless recessed version with diffused direct light emission. Additionally, LBS also allows to make use of directional projectors, that can be hooked and wired to the profile.

LBS es una cinta de perfil de aluminio extruido muy delgada, que puede ser instalada como plafón, como colgante, de pared o empotrado. Compuesto de módulos base, dependiendo de la manera en que se ensamblan, puede tomar la forma de un arco (para instalarse en la pared), de un círculo (para formar colgantes, plafones y empotrables "trimless") o de una línea sinuosa (para formar un sistema que corre a lo largo del techo). El material extruido que forma el cuerpo está diseñado de manera que pueda alojar la fuente LED lineal, escudada con un difusor blanco opalino, tanto en el lado vertical interno -y, por lo tanto, emite la luz en el eje horizontal- como en el lado horizontal, más estrecho, para así emitir la luz en el eje vertical (indirecta). En las versiones de plafón, empotrado y colgante está disponible, además, con emisión difusa hacia abajo. LBS, por último, permite también el uso de proyectores para luz dirigida y de realce, adicional a este mismo, que pueden ser enganchados y conectados a la electricidad.

**LBS**  
**LIGHT BAND SYSTEM**

**PASTICCERIA SEBASTIANO CARIDI - FAENZA (RA)**  
**PROJECT FORMAT DESIGN STUDIO IMOLA (BO)**  
**PHOTO R. MONTILLO**







*Light Ban*





## SEZIONI PROFILO LBS

### INCASSO RASATO - TRIMLESS RECESSED - TOTAL EMPOTRADO

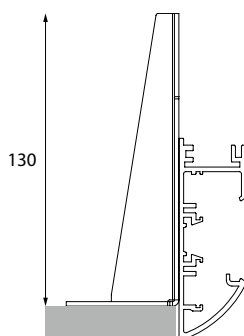

luce diretta  
direct light  
luz directa

### SOFFITTO - CEILING - TECHO

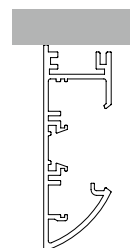

luce indiretta  
indirect light  
luz indirecta



luce diretta  
direct light  
luz directa

**SOSPENSIONE - SUSPENSION - SUSPNSION**

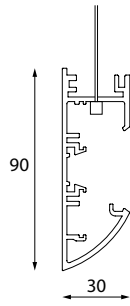

luce indiretta  
indirect light  
luz indirecta



luce diretta  
direct light  
luz directa

**PARETE - WALL - PARED**

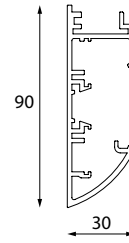

diffusore microprismatico  
microprismatic diffuser  
difusor microprismatico

Famiglia di profili curvi in estruso di alluminio di 90 x 30 mm. e raggi 367 mm. - 517 mm. - 717 mm., disponibili come moduli finiti in versione sospensione, plafone e incasso trimless circolari e applique ad arco, o da assemblare a sistema a plafone o sospeso di forma sinusoidale. Possibile scegliere tra emissione luminosa laterale interna o esterna al profilo, diretta/diffusa e indiretta, fornita da strip led con driver remoto, alloggiabile in apposito rosone o in controsoffitto (reglette led con driver integrato nella versione ad emissione diretta/diffusa). Diffusore in policarbonato opalino bianco. Integrabile con proiettori orientabili da agganciare al profilo completi di sorgente led chip on board e driver remoto. Installazione a parete, a soffitto, a sospensione e a incasso trimless a scomparsa totale. Grado di protezione IP40/IP43

Extruded aluminum curved profiles programme. Profile dimensions: 90 x 30 mm. and radius 367 mm. - 517 mm. - 717 mm. Available in round suspended, ceiling-mounted and trimless recessed versions (default modules), in arc-shaped wall-mounted version (default module), or as modules to assemble together to form a sinusoidal system, ceiling-mounted or suspended. Available with the following lighting emissions: horizontal from the internal or external side of the profile, direct/diffused and indirect, provided by strip led (driver to be installed remote in a separate ceiling canopy or onto the false-ceiling) or by led batten with integrated driver (on direct/diffused lighting emission only). Opal white polycarbonate diffuser. The profile can be integrated with chip on board led adjustable projectors (remote driver), to be hung to the on the profile. Degree of protection IP40/IP43

Familia de perfiles curvos en estruso de aluminio de 90x30 mm y radios 367 mm - 517 mm. - 717 mm, disponibles como módulos acabados en versión suspensión, plafón y empotrado trimless circulares y aplique a arco, o para ensamblar a medida (sistema) a plafón o suspendido con forma sinusoidal. Posibilidad de elegir entre luz lateral interna o externa al perfil, directa/difuminada e indirecta, con strip led con driver remoto, que se puede instalar en el florón o en el falso techo (regletas led con driver integrado en la versión de emisión directa/difuminada), Difusor en policarbonato opal blanco. Integrable con proyectores orientables para enganchar al perfil, con led chip on board y driver remoto. Instalación a pared, techo, suspensión y empotrado trimless. Grado de protección IP40/IP43.





## LBS LIGHT BAND SYSTEM

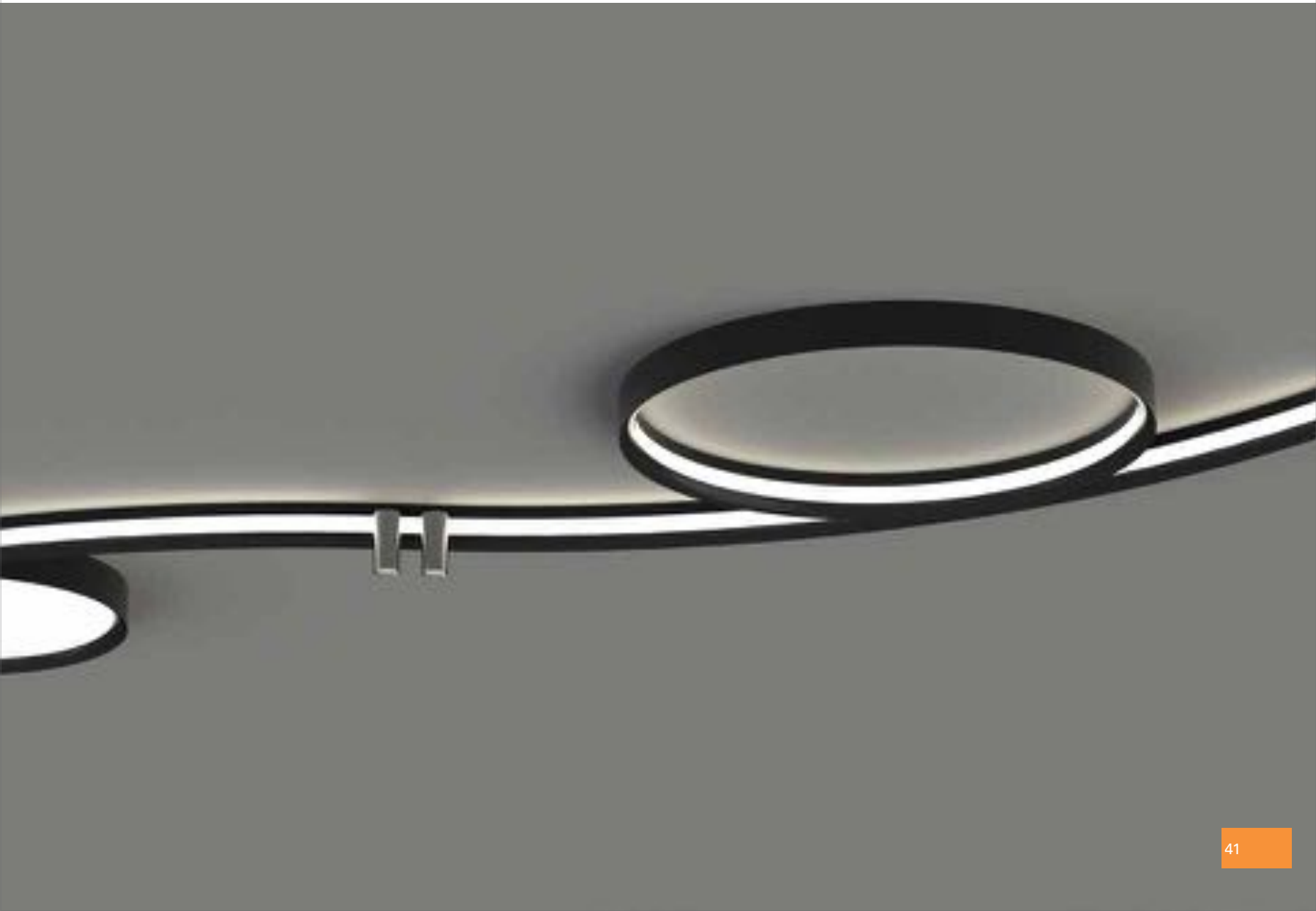

## LBS INCASSO RASATO LUCE DIRETTA/DIFFUSA

TRIMLESS RECESSED DIRECT/DIFFUSED EMISSION - TOTAL EMPOTRADO EMISIÓN DIRECTA/DIFFUSA



LED

W	K	lm product	lm/Led	CRI	DaliT&D	Dim.	CODE	Col.
48	3000	3358	4720	80	x	ø735	<b>LB041.830D</b>	<b>01 02</b>
96	3000	6717	9440	80		ø1035	<b>LB042.830</b>	<b>01 02</b>
96	3000	6717	9440	80	x	ø1035	<b>LB042.830D</b>	<b>01 02</b>
168	3000	11754	16520	80		ø1335	<b>LB043.830</b>	<b>01 02</b>
168	3000	11754	16520	80	x	ø1335	<b>LB043.830D</b>	<b>01 02</b>
48	4000	3842	5400	80	x	ø735	<b>LB041.840D</b>	<b>01 02</b>
96	4000	7684	10800	80		ø1035	<b>LB042.840</b>	<b>01 02</b>
96	4000	7684	10800	80	x	ø1035	<b>LB042.840D</b>	<b>01 02</b>
168	4000	13447	18900	80		ø1335	<b>LB043.840</b>	<b>01 02</b>
168	4000	13447	18900	80	x	ø1335	<b>LB043.840D</b>	<b>01 02</b>

A+

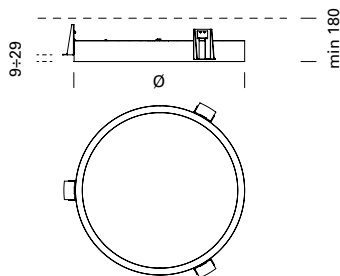

 pag.824



## LBS SOFFITTO LUCE PERIMETRALE

CEILING PERIMERIC EMISSION TECO - EMISION PERIMETRAL



LINEAR LED	W	K	lm product	lm/Led	CRI	A	Dim.	CODE	Col.
18W/MT 168 LED/MT 2200LM/MT 24V	40	3000	3441	4836	>80	V.2	ø735	<b>LB001.830</b>	<b>01 02</b>
	57	3000	4915	6908	>80	V.2	ø1035	<b>LB002.830</b>	<b>01 02</b>
	75	3000	6389	8980	>80	V.2	ø1335	<b>LB003.830</b>	<b>01 02</b>

LINEAR LED	W	K	lm product	lm/Led	CRI	A	Dim.	CODE	Col.
18W/MT 168 LED/MT 2300LM/MT 24V	40	4000	3597	5055	>80	V.2	ø735	<b>LB001.840</b>	<b>01 02</b>
	57	4000	5138	7222	>80	V.2	ø1035	<b>LB002.840</b>	<b>01 02</b>
	75	4000	6680	9388	>80	V.2	ø1335	<b>LB003.840</b>	<b>01 02</b>

Da completare con alimentatore da installare remoto in scatola di derivazione | To be completed with power supply to be installed in a remote junction box | A ser completado con alimentador para el montaje en la caja de conexiones a distancia.

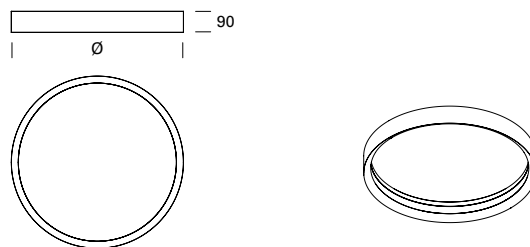

## LBS SOFFITTO LUCE DIRETTA/DIFFUSA

CEILING MOUNTED DIRECT/DIFFUSED EMISSION - TECO EMISION DIRECTA/DIFUSA



LED	W	K	lm product	lm/Led	CRI	DaliT&D	Dim.	CODE	Col.
	48	3000	3358	4720	80	x	ø735	<b>LB021.830D</b>	<b>01 02</b>
	96	3000	6717	9440	80		ø1035	<b>LB022.830</b>	<b>01 02</b>
	96	3000	6717	9440	80	x	ø1035	<b>LB022.830D</b>	<b>01 02</b>
	168	3000	11754	16520	80		ø1335	<b>LB023.830</b>	<b>01 02</b>
	168	3000	11754	16520	80	x	ø1335	<b>LB023.830D</b>	<b>01 02</b>
	48	4000	3842	5400	80	x	ø735	<b>LB021.840D</b>	<b>01 02</b>
	96	4000	7684	10800	80		ø1035	<b>LB022.840</b>	<b>01 02</b>
	96	4000	7684	10800	80	x	ø1035	<b>LB022.840D</b>	<b>01 02</b>
	168	4000	13447	18900	80		ø1335	<b>LB023.840</b>	<b>01 02</b>
	168	4000	13447	18900	80	x	ø1335	<b>LB023.840D</b>	<b>01 02</b>

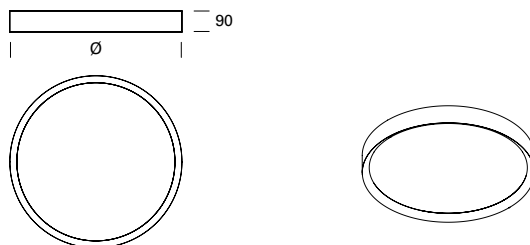



01 - bianco - white - blanco 02 - nero - black - negro

pag.824 **A** pag.820

## LBS SOFFITTO CURVA ESSE

CEILING S-CURVE - TECHO CURVA DE S

	W	K	lm product	lm/Led	CRI	A	Dim.	Lmm	CODE	Col.	
 <p>LINEAR LED 18W/MT 168 LED/MT 2200LM/MT 24V</p> <p><b>A+</b></p>	72	3000	6261	88	80	V.2	562x	4990	LB210.830	01 02	
	72	4000	6546	9200	80	V.2	562x	4990	LB210.840	01 02	

Da completare con alimentatore da installare remoto in scatola di derivazione | To be completed with power supply to be installed in a remote junction box | A ser completado con alimentador para el montaje en la caja de conexiones a distancia.

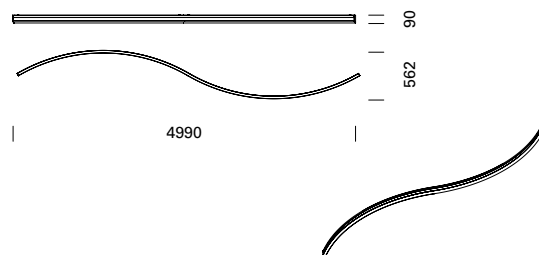

## LBS SOSPENSIONE LUCE PERIMETRALE

SUSPENSION PERIMERIC EMISSION - SUSPENSION CON EMISION LATERAL



LINEAR LED	W	K	lm product	lm/Led	CRI	A	Dim.	CODE	Col.
18W/MT 168 LED/MT 2200LM/MT 24V	40	3000	3441	4836	>80	V.2	ø735	LB011.830	01 02
	57	3000	4915	6908	>80	V.2	ø1035	LB012.830	01 02
	75	3000	6389	8980	>80	V.2	ø1335	LB013.830	01 02

LINEAR LED	W	K	lm product	lm/Led	CRI	A	Dim.	CODE	Col.
18W/MT 168 LED/MT 2300LM/MT 24V	40	4000	3597	5055	>80	V.2	ø735	LB011.840	01 02
	57	4000	5138	7222	>80	V.2	ø1035	LB012.840	01 02
	75	4000	6680	9388	>80	V.2	ø1335	LB013.840	01 02

Da completare con alimentatore, rosone e cavo di alimentazione | To be completed with power supply, canopy and feed cable | A ser completado con alimentador, florón y cable de alimentación.

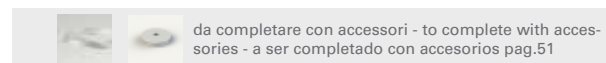
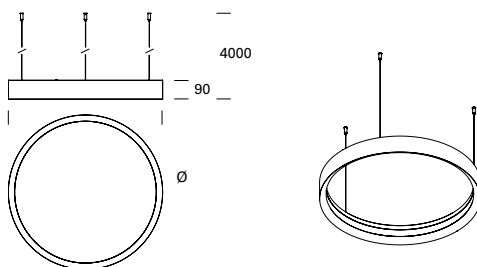

## LBS SOSPENSIONE LUCE DIRETTA/DIFFUSA

SUSPENSIONE DIRECT AND DIFFUSED EMISSION - SUSPENSION EMISION DIRECTA/DIFUSA



LED	W	K	lm product	lm/Led	CRI	DaliT&D	Dim.	CODE	Col.
	48	3000	3358	4720	>80	x	ø735	LB031.830D	01 02
	96	3000	6717	9440	>80		ø1035	LB032.830	01 02
	96	3000	6717	9440	>80	x	ø1035	LB032.830D	01 02
	168	3000	11754	16520	>80		ø1335	LB033.830	01 02
	168	3000	11754	16520	>80	x	ø1335	LB033.830D	01 02

	48	4000	5400	5400	>80	x	ø735	LB031.840D	01 02
	96	4000	10800	10800	>80		ø1035	LB032.840	01 02
	96	4000	10800	10800	>80	x	ø1035	LB032.840D	01 02
	168	4000	18900	18900	>80		ø1335	LB033.840	01 02
	168	4000	18900	18900	>80	x	ø1335	LB033.840D	01 02

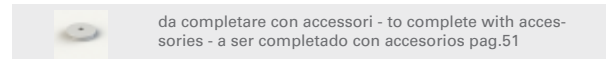
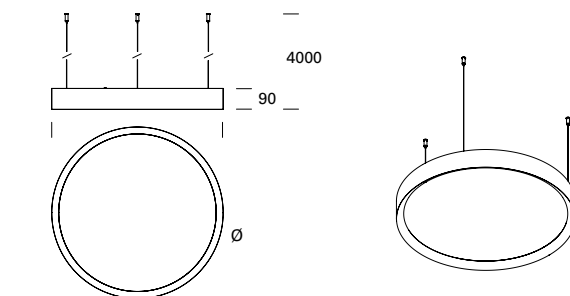

pag.824 **A** pag.820

# LBS PARETE

WALL-MOUNTED - PARED



	W	K	lm product	lm/Led	CRI	A	Lmm	CODE	Col.	
LINEAR LED 18W/MT 168 LED/MT 2200LM/MT <b>A+</b>	17	3000	1565	2200	>80	V.2	950	<b>LB201.830</b>	<b>01 02</b>	IP43 LED rec
	28	3000	2348	3300	>80	V.2	1530	<b>LB202.830</b>	<b>01 02</b>	
	35	3000	3131	4400	>80	V.2	1945	<b>LB203.830</b>	<b>01 02</b>	

	W	K	lm product	lm/Led	CRI	A	Lmm	CODE	Col.	
LINEAR LED 18W/MT 168 LED/MT 2300LM/MT <b>A+</b>	17	4000	1636	2300	>80	V.2	950	<b>LB201.840</b>	<b>01 02</b>	IP43 LED rec
	28	4000	2455	3450	>80	V.2	1530	<b>LB202.840</b>	<b>01 02</b>	
	35	4000	3273	4600	>80	V.2	1945	<b>LB203.840</b>	<b>01 02</b>	

Da completare con alimentatore da installare remoto in scatola di derivazione | To be completed with power supply to be installed in a remote junction box | A ser completado con alimentador para el montaje en la caja de conexiones a distancia.

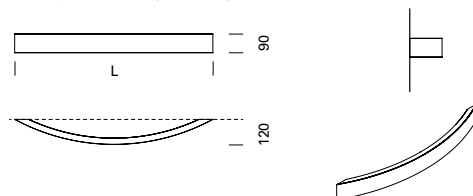

 pag.824 **A** pag.820



# LBS PROIETTORE SPOT

SPOT PROJECTOR - PROYECTOR SPOT



LED

3SDCM  
50000h L90  
B10 ta 25°C

A+

W	mA	K	lm product	lm/Led	CRI	△	A	H	∅	CODE	Col.
11	350	2700	931	1100	>90	29°	3.2	125	∅55	LB101.927F	01 02 31 32
11	350	2700	703	1100	>90	42°	3.2	125	∅55	LB101.927W	01 02 31 32
11	350	3000	1003	1185	>90	29°	3.2	125	∅55	LB101.930F	01 02 31 32
11	350	3000	757	1185	>90	42°	3.2	125	∅55	LB101.930W	01 02 31 32
11	350	4000	1088	1285	>90	29°	3.2	125	∅55	LB101.940F	01 02 31 32
11	350	4000	821	1285	>90	42°	3.2	125	∅55	LB101.940W	01 02 31 32



Installabile su tutti i prodotti a luce perimetrale - suitable to fit in perimetric emission fittings - Instalable en todos los productos de luz perimetral.

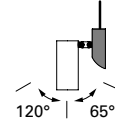
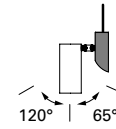
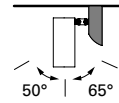
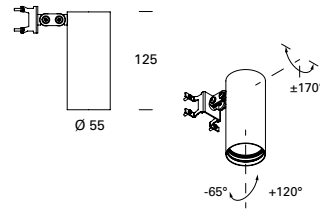

installazione a soffitto /  
ceiling-mounting /  
instalación a techo

installazione a parete /  
wall-mounting /  
instalación a pared

installazione a sospensione /  
suspension-mounting /  
instalación a susension

01 - bianco - white - blanco    02 - nero - black - negro    31 - cromo-giunti bianchi - chrome - white joints - cromo - juntas blancas    32 - cromo-giunti neri - chrome - black joints - cromo - juntas negras



## CERCHIO PER LUCE PERIMETRALE INTERNA

RING FOR INTERNAL PERIMETRIC EMISSION - ANILLO PARA LUZ PERÍMETRO INTERIOR

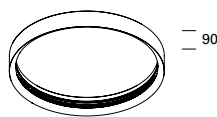
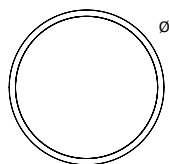

Dim.  
 ø735  
 ø1035  
 ø1335

CODE	Col.
LB301	01 02
LB302	01 02
LB303	01 02

## SEMICERCHIO PER LUCE PERIMETRALE INTERNA

HALF-RING FOR INTERNAL PERIMETRIC EMISSION - MEDIO ANILLO PARA LUZ PERÍMETRO INTERIOR

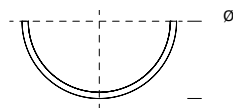

Dim.  
 ø 735  
 ø 1035  
 ø 1335

CODE	Col.
LB320	01 02
LB321	01 02
LB322	01 02

## 1/4 DI CERCHIO LUCE INTERNA

A QUARTER-RING FOR INTERNAL EMISSION - 1/4 ANILLO PARA LUZ PERÍMETRO INTERIOR

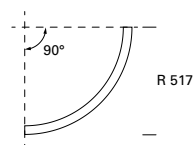

Dim. R mm  
 ø1035

CODE	Col.
LB323	01 02

## TRATTO RETTILINEO

STRAIGHT PROFILE - LINEAL PERFIL

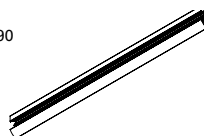
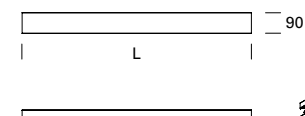

Lmm  
 1000  
 2000  
 3000

CODE	Col.
LB340	01 02
LB341	01 02
LB342	01 02

01 - bianco - white - blanco 02 - nero - black - negro



## COPPIA DI TESTATE DI CHIUSURA

COUPLE OF CLOSURE HEADS - PAREJA DE TAPAS FINALES

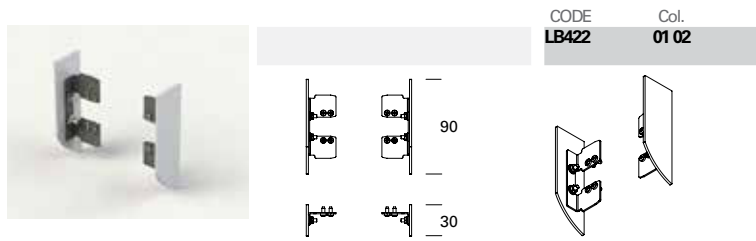

## DIFFUSORE INDIRETTO LINEARE

INDIRECT LINEAR DIFFUSER - DIFUSOR LINEAL INDIRECTO

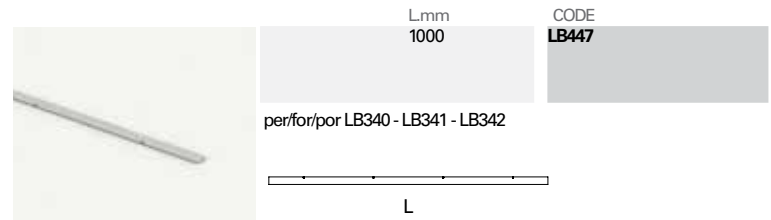

## DIFFUSORE PERIMETRALE

PERIMETRIC DIFFUSER - DIFUSOR DE PERIMETRO

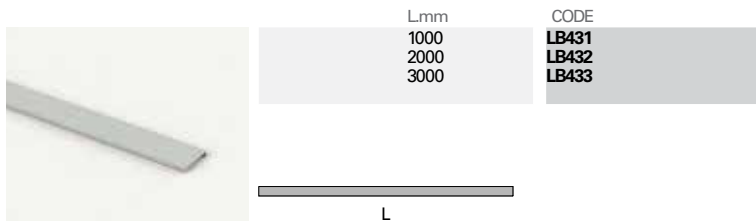

## DIFFUSORE INDIRETTO SEMICERCHIO

HALF-RING DIFFUSER FOR INDIRECT EMISSION - DIFUSOR INDIRECTO POR MEDIO ANILLO

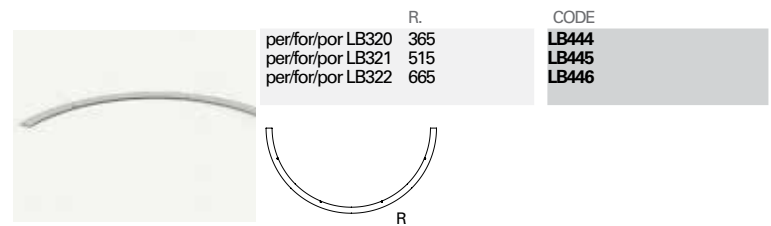

## COVER PERIMETRALE VERNICIATO(CIECO)

PERIMETRIC SLOT CLOSURE ELEMENT - TAPA DE PERIMETRO

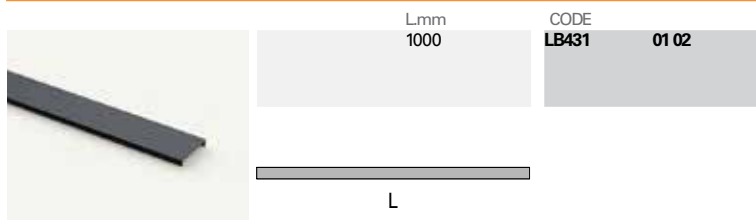

## KIT DIFFUSORE INDIRETTO

DIFFUSER KIT FOR INDIRECT EMISSION - KIT DIFUSOR INDIRECTO

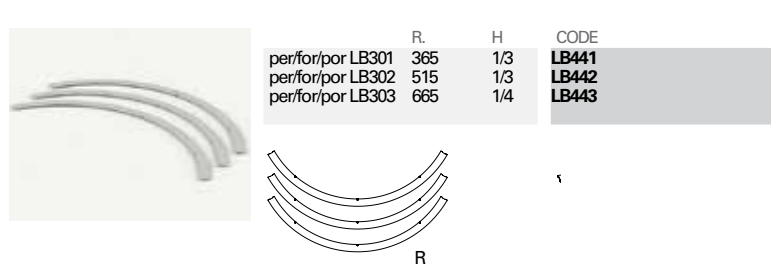

## KIT SOFFITTO PUNTO DI ATTACCO

CEILING HANGING KIT - ANCLAJE PARA TECHO

CODE  
LB424



## GIUNTO INTERNO

INTERNAL JOINT - JUNTO INTERIOR

CODE  
LB426

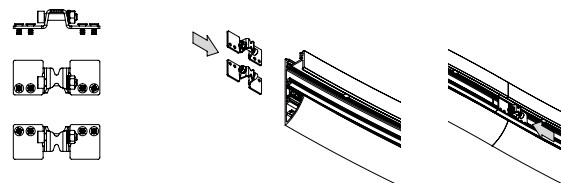

## GIUNTO SUPERIORE

UPPER JOINT - JUNTO SUPERIOR

CODE  
LB425

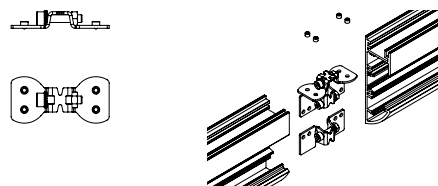

## GIUNTO DI CONNESSIONE TRA SOSPENSIONE DIRETTA E PERIMETRALE

JOINT TO CONNECT SUSPENSION PERIMETRIC EMISSION TO SUSPENSION DIRECT-DIFFUSED EMISSION - CONEXIÓN ENTRE SUSPENSIÓN DIRECTA Y PERIMETRAL.

CODE  
LB427

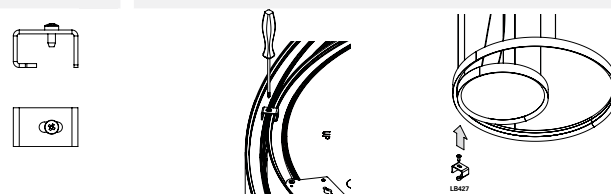

## CAVO DI ALIMENTAZIONE

POWER CABLE- ALIMENTACIÒN



Dim.	Lmm	Kg	CODE
3X1	2000	0.18	<b>LB403.2</b>
3X1	4000	0.36	<b>LB403.4</b>
5X1	2000	0.30	<b>LB405.2</b>
5X1	4000	0.60	<b>LB405.4</b>
7X1	2000	0.30	<b>LB407.2</b>
7X1	4000	0.60	<b>LB407.4</b>
9X1	2000	0.30	<b>LB409.2</b>
9X1	4000	0.60	<b>LB409.4</b>

## KIT SOSPENSIONE 1 CAVO ACCIAIO

SINGLE STEEL HANGING KIT- KIT JUNTA DE SUSPENSION

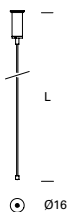

Lmm	CODE
2000	<b>LB423.2</b>
4000	<b>LB423.4</b>

## ROSONE 230V

CANOPY 230V- FLORON 230V

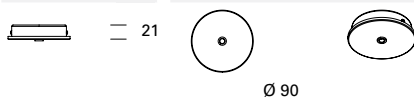

Kg	CODE	Col.
0.18	<b>LB420</b>	<b>01 02</b>

## ROSONE PER CARTONGESSO

CANOPY FOR PLASTERBOARD FALSE-CEILING - FLORON PARA LOS FALSO TECHO

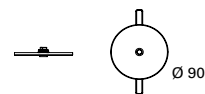

Kg	CODE	Col.
0.18	<b>LB428</b>	<b>01 02</b>

## ROSONE PER ALLOGGIAMENTO DRIVER

CANOPY FOR HOUSING DRIVER - FLORON PARA LOS DRIVER

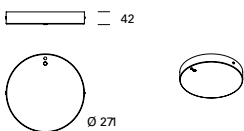

Kg	CODE	Col.
0.18	<b>LB421</b>	<b>01 02</b>

01 - bianco - white - blanco 02 - nero - black - negro

## CATENA STRIP LED INDIRETTA SEMICERCHIO

STRIP LED TO COVER HALF-RING FOR INDIRECT EMISSION - CADENA STRIP LED INDIRETTA EMISION POR MEDIO ANILLO



	W	K	lm product	lm/Led	CRI	A	Dim.	CODE	
LINEAR LED 11W/MT 98 LED/MT 1200lm MT 24V <b>A+</b>	7,7	3000	840	840	80	V.2	ø700	CST.011.830	
	11	3000	1200	1200	80	V.2	ø1000	CST.012.830	
	14,3	3000	1560	1560	80	V.2	ø1300	CST.013.830	
LINEAR LED 14,4W/ MT 60 LED/MT 960lm MT 24V <b>A+</b>	10	4000	672	672	80	V.2	ø700	CST.011.840	
	14,4	4000	960	960	80	V.2	ø1000	CST.012.840	
	18,7	4000	1430	1430	80	V.2	ø1300	CST.013.840	

## CATENA STRIP LED INDIRETTA PER CERCHIO

STRIP LED FOR INDIRECT EMISSION FOR ARCH - CADENA STRIP LED INDIRETTA EMISION POR ANILLO

	W	K	lm product	lm/Led	CRI	A	Dim.	CODE	
LINEAR LED 11W/MT 98 LED/MT 1200lm MT 24V <b>A+</b>	7,7	3000	840	840	80	V.2	ø700	CST.001.830	
	11	3000	1200	1200	80	V.2	ø1000	CST.002.830	
	14,3	3000	1560	1560	80	V.2	ø1300	CST.003.830	
LINEAR LED 14,4W/ MT 60 LED/MT 960lm MT 24V <b>A+</b>	10	4000	672	672	80	V.2	ø700	CST.001.840	
	14,4	4000	960	960	80	V.2	ø1000	CST.002.840	
	18,7	4000	1430	1430	80	V.2	ø1300	CST.003.840	

## CATENA STRIP LED INDIRETTA PER PARETE

STRIP LED FOR INDIRECT EMISSION FOR WALL-MOUNTED - CADENA STRIP LED INDIRETTA EMISION POR PARED

	W	K	lm product	lm/Led	CRI	A	Lmm	CODE	
LINEAR LED 11W/MT 98 LED/MT 1200lm MT 24V <b>A+</b>	10,4	3000	1140	1140	80	V.2	950	CST.021.830	
	16,8	3000	1836	1836	80	V.2	1530	CST.022.830	
	21,6	3000	2334	2334	80	V.2	1945	CST.023.830	
LINEAR LED 14,4W/ MT 60 LED/MT 960lm MT 24V <b>A+</b>	14,4	4000	960	960	80	V.2	950	CST.021.840	
	22	4000	1469	1469	80	V.2	1530	CST.022.840	
	28	4000	1868	1868	80	V.2	1945	CST.023.840	

## STRIP LED PER LUCE PERIMETRALE



	W/mt	V	Led/mt	lm/mt	K	lm product	lm/W	CRI	IP	A	Lmm	CODE		
LINEAR LED 24V <b>A+</b>	11	24	180	1200	3000	6000	545	80	20	V.2	5000	0,18	ST11.30.5	
	18	24	168	2200	3000	11000	611	80	20	V.2	5000	0,18	ST21.30.5	

**STRIP LED**

nr.max	
AE50.24V	<b>2</b>
AE75.24V	
AE100.1.24V	
AE150.24VIP	
AE150D.24VIP	
AE100D.24V	<b>1</b>

**STRIP LED**

+

**SPOT LED**

AE50.24V	<b>1</b>
AE75.24V	
AE100.1.24V	
AE150.24VIP	
AE150D.24VIP	
AE100D.24V	

**SPOT LED**

AE350.16C*	<b>2</b>
AE350.25C**	
AE700.20CD.MP*	

**SPOT LED**

AE350.16C*	<b>5</b>
AE350.25C**	
AE700.20CD.MP*	

\* x 1 SPOT  
\*\* x 2 SPOT

Programma di proiettori fissi e orientabili per sorgenti LED Chip On Board integrate. Possibilità di montaggio: a incasso, rasato a scomparsa totale e con cornice di battuta, a soffitto e parete, a binario eurostandard 230V e all'interno sia dei profili Lucifero's Minifile e File 2 che nei relativi Container. Corpo apparecchio in estruso di alluminio verniciato. Gruppi ottici completi di led chip on board, lente, housing antiabbagliamento e driver (tranne versioni a incasso e a parete/soffitto 1x e 3x). Versione orientabile a parete/soffitto e da inserire nel Container per Minifile Lucifero's dotata di speciale meccanismo roto-traslante che permette l'estrazione del proiettore e il suo orientamento di 350° sull'asse verticale e 350° sull'asse orizzontale. Versione orientabile da inserire nel Container per File 2 Lucifero's dotata di speciale meccanismo basculante che permette l'estrazione del proiettore e il suo orientamento di +/-45° sull'asse orizzontale. Ottiche spot, flood e wide. UGR<19. Grado di protezione IP23/43.

Fix and adjustable projectors programme for chip on board LED sources. Mounting options: with frame and trimless recessed, ceiling and wall-mounted, 230V Eurostandard track and within the Lucifero's Container for Minifile and File 2. Fixture's body in painted extruded aluminum. Optical group complete with chip on board led, lens, antiglare housing and driver (except recessed versions and 1x and 3x ceiling/wall-mounted versions). Adjustable version for ceiling/wall mounting and for insertion within the Container for Minifile provided with special patented Soft Rotate & Slide mechanism, that allows the projector's extraction and aiming of 350° on the vertical axis and of 350° on the horizontal axis. Adjustable version for insertion within the Container for File 2 provided with special tilt mechanism, that allows the projector's extraction and aiming of +/-45° on the horizontal axis. Spot, flood and wide optics. UGR<19. Degree of protection IP23/43.

Programa de proyectores fijos y orientables para LED Chip On Board integrados. Posibilidades de montaje: empotrado, empotrado total y con marco, para techo y pared, y para raíl Eurostandard 230V y para interior de los perfiles Lucifero's Minifile y File 2 y para los correspondientes containers. Cuerpo del aparato en estruso de aluminio barnizado. Grupos ópticos con ledchip on board, lente, housing anti deslumbramiento y driver (excluido para las versiones empotradas y a pared/techo 1x y 3x). Versión orientable a pared/techo y para colocar en los containers Minifile Lucifero's con especial mecanismo roto-traslante que permite la extracción del proyector y su orientación en 350° sobre el eje vertical y 350° sobre el eje horizontal. Versión orientable para colocar en el contanier para File 2 Lucifero's con mecanismo especial basculante que permite la extracción del proyector y su orientación de +/- 45° sobre el eje horizontal. Ópticas spot, flood y wide UGR<19. Grado de protección IP23/43.

**LEVA**









**1**

**PROFILE**



CONTAINER MINIFILE

**2**

**LIGHTING MODULE**

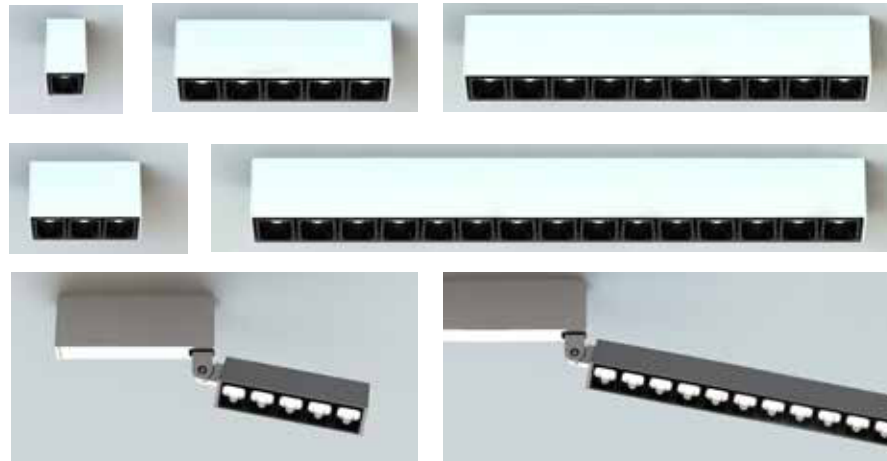

**3**

**SYSTEM**





FILE2 CONTAINER



MINIFILE SYSTEM



FILE2 SYSTEM

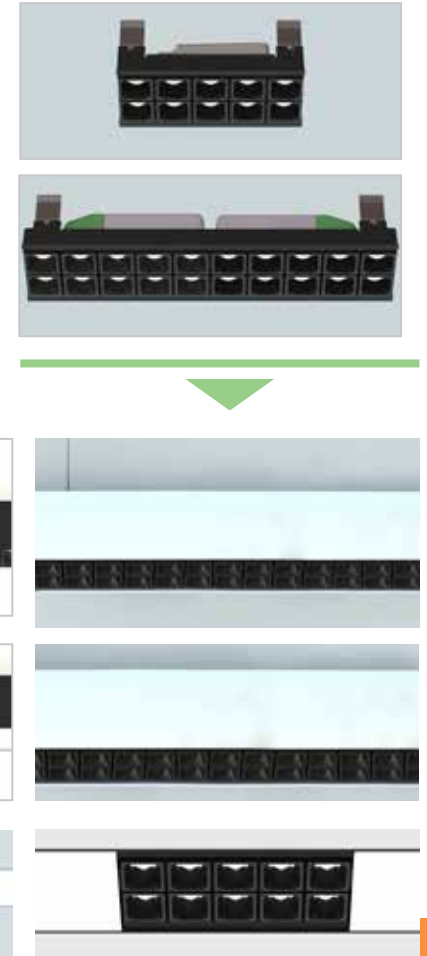
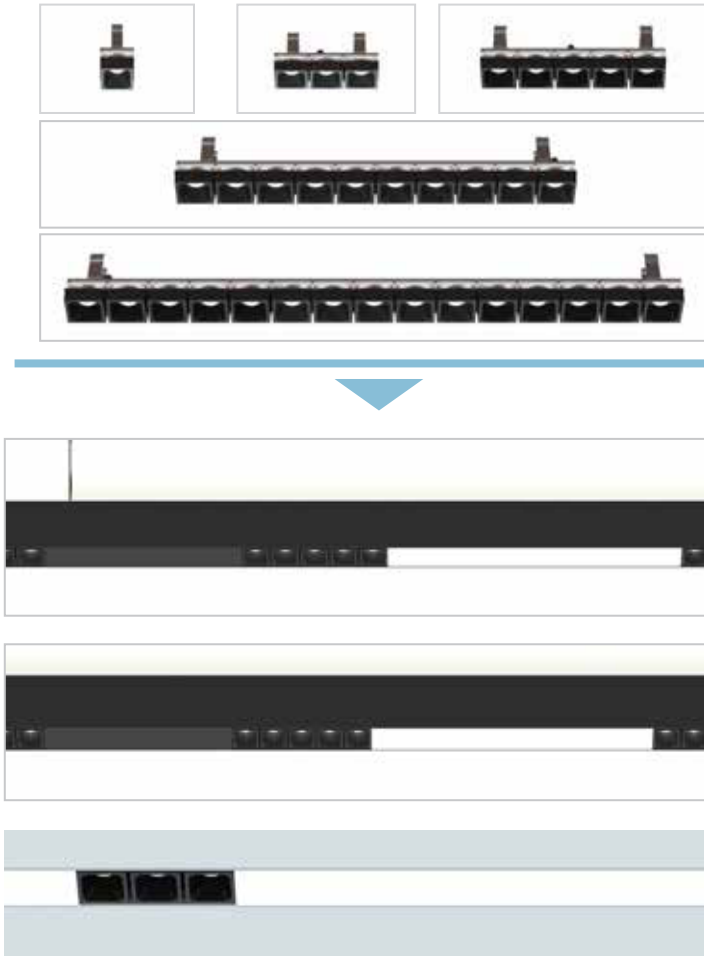
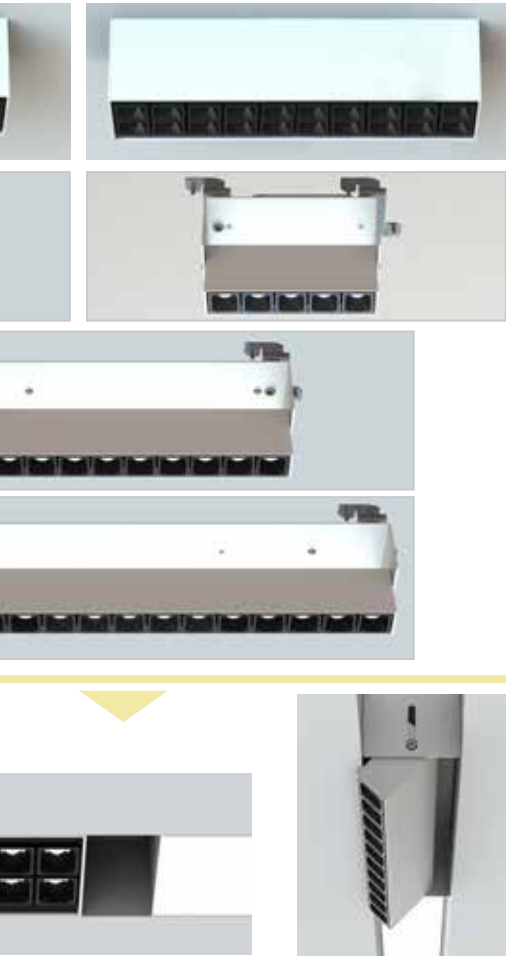

## LEVA INCASSO 1

DOWNLIGHTER - EMPOTRADO

UGR < 19  34x36

LED	W	mA	K	lm product	lm/Led	CRI	△	A	Dim.	H	CODE	Col.
3SDCM 50000h L90 B10 Ta 25°C 	1x1,5	500	2700	196	168	95	19°	5.1	40x42	90	LV011.927S	01 02 41 42
	1x1,5	500	2700	141	168	95	33°	5.1	40x42	90	LV011.927F	01 02 41 42
	1x1,5	500	2700	155	168	95	56°	5.1	40x42	90	LV011.927W	01 02 41 42
	1x1,5	500	3000	196	168	95	19°	5.1	40x42	90	LV011.930S	01 02 41 42
	1x1,5	500	3000	141	168	95	33°	5.1	40x42	90	LV011.930F	01 02 41 42
	1x1,5	500	3000	155	168	95	56°	5.1	40x42	90	LV011.930W	01 02 41 42
	1x1,5	500	4000	196	168	95	19°	5.1	40x42	90	LV011.940S	01 02 41 42
	1x1,5	500	4000	141	168	95	33°	5.1	40x42	90	LV011.940F	01 02 41 42
	1x1,5	500	4000	155	168	95	56°	5.1	40x42	90	LV011.940W	01 02 41 42

Da completare con alimentatore da installare remoto in scatola di derivazione | To be completed with power supply to be installed in a remote junction box | A ser completado con alimentador para el montaje en la caja de conexiones a distancia.

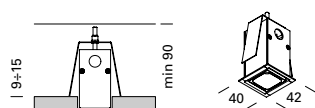
## LEVA INCASSO 3

DOWNLIGHTER - EMPOTRADO

UGR < 19  34x96

LED	W	mA	K	lm product	lm/Led	CRI	△	A	Dim.	H	CODE	Col.
3SDCM 50000h L90 B10 Ta 25°C 	3x1,5	500	2700	588	504	95	19°	5.1	40x102	90	LV012.927S	01 02 41 42
	3x1,5	500	2700	423	504	95	33°	5.1	40x102	90	LV012.927F	01 02 41 42
	3x1,5	500	2700	465	504	95	56°	5.1	40x102	90	LV012.927W	01 02 41 42
	3x1,5	500	3000	588	504	95	19°	5.1	40x102	90	LV012.930S	01 02 41 42
	3x1,5	500	3000	423	504	95	33°	5.1	40x102	90	LV012.930F	01 02 41 42
	3x1,5	500	3000	465	504	95	56°	5.1	40x102	90	LV012.930W	01 02 41 42
	3x1,5	500	4000	588	504	95	19°	5.1	40x102	90	LV012.940S	01 02 41 42
	3x1,5	500	4000	423	504	95	33°	5.1	40x102	90	LV012.940F	01 02 41 42
	3x1,5	500	4000	465	504	95	56°	5.1	40x102	90	LV012.940W	01 02 41 42

Da completare con alimentatore remoto - To be completed with remote driver - A completar con alimentador remoto

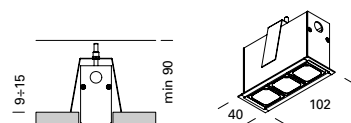
-  01 - telaio bianco - ottica nera - white box - black optic - marco blanco optica negra
-  02 - telaio nero - ottica nera - black box - black optic - marco negro - optica negra
-  41 - telaio bianco - ottica bianca - white box - white optic - marco blanco - optica blanca
-  42 - telaio nero - ottica dorata - black box - golden optic - marco negro - optica dorada

## LEVA INCASSO 5

DOWNLIGHTER - EMPOTRADO

UGR < 19  34x156



LED	W	mA	K	lm product	lm/Led	CRI	∠	A	Dim.	H	CODE	Col.
3SDCM 50000h L90 B10 Ta 25°C	5x1,5	500	2700	980	840	95	19°	5.1	40x162	90	LV013.927S	01 02 41 42
	5x1,5	500	2700	705	840	95	33°	5.1	40x162	90	LV013.927F	01 02 41 42
	5x1,5	500	2700	775	840	95	56°	5.1	40x162	90	LV013.927W	01 02 41 42
	5x1,5	500	3000	980	840	95	19°	5.1	40x162	90	LV013.930S	01 02 41 42
	5x1,5	500	3000	705	840	95	33°	5.1	40x162	90	LV013.930F	01 02 41 42
	5x1,5	500	3000	775	840	95	56°	5.1	40x162	90	LV013.930W	01 02 41 42
	5x1,5	500	4000	980	840	95	19°	5.1	40x162	90	LV013.940S	01 02 41 42
	5x1,5	500	4000	705	840	95	33°	5.1	40x162	90	LV013.940F	01 02 41 42
	5x1,5	500	4000	775	840	95	56°	5.1	40x162	90	LV013.940W	01 02 41 42

Da completare con alimentatore remoto -To be completed with remote driver - A completar con alimentador remoto

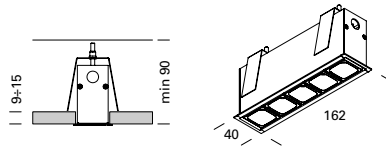

## LEVA INCASSO 10

DOWNLIGHTER - EMPOTRADO

UGR < 19  34x306



LED	W	mA	K	lm product	lm/Led	CRI	∠	A	Dim.	H	CODE	Col.
3SDCM 50000h L90 B10 Ta 25°C	10x1,5	500	2700	1960	1680	95	19°	5.1	40x312	90	LV014.927S	01 02 41 42
	10x1,5	500	2700	1410	1680	95	33°	5.1	40x312	90	LV014.927F	01 02 41 42
	10x1,5	500	2700	1550	1680	95	56°	5.1	40x312	90	LV014.927W	01 02 41 42
	10x1,5	500	3000	1960	1680	95	19°	5.1	40x312	90	LV014.930S	01 02 41 42
	10x1,5	500	3000	1410	1680	95	33°	5.1	40x312	90	LV014.930F	01 02 41 42
	10x1,5	500	3000	1550	1680	95	56°	5.1	40x312	90	LV014.930W	01 02 41 42
	10x1,5	500	4000	1960	1680	95	19°	5.1	40x312	90	LV014.940S	01 02 41 42
	10x1,5	500	4000	1410	1680	95	33°	5.1	40x312	90	LV014.940F	01 02 41 42
	10x1,5	500	4000	1550	1680	95	56°	5.1	40x312	90	LV014.940W	01 02 41 42

Da completare con alimentatore remoto -To be completed with remote driver - A completar con alimentador remoto

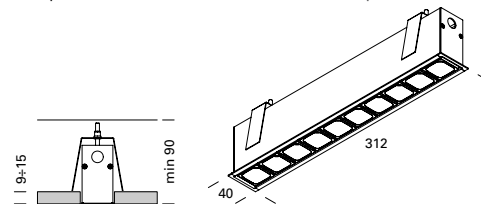

-  01 - telaio bianco - ottica nera - white box - black optic - marco blanco optica negra
-  02 - telaio nero - ottica nera - black box - black optic - marco negro - optica negra
-  41 - telaio bianco - ottica bianca - white box - white optic - marco blanco - optica blanca
-  42 - telaio nero - ottica dorata - black box - golden optic - marco negro - optica dorada

 pag.824

**A** pag.820

## LEVA INCASSO 15

DOWNLIGHTER - EMPOTRADO

UGR < 19  34x456



LED

3SDCM  
50000h L90  
B10 Ta 25°C

A+

W	mA	K	lm product	lm/Led	CRI	∠	A	Dim.	H	CODE	Col.
15x1,5	500	2700	2940	2520	95	19°	5.1	40x462	90	LV015.927S	01 02 41 42
15x1,5	500	2700	2115	2520	95	33°	5.1	40x462	90	LV015.927F	01 02 41 42
15x1,5	500	2700	2325	2520	95	56°	5.1	40x462	90	LV015.927W	01 02 41 42
15x1,5	500	3000	2940	2520	95	19°	5.1	40x462	90	LV015.930S	01 02 41 42
15x1,5	500	3000	2115	2520	95	33°	5.1	40x462	90	LV015.930F	01 02 41 42
15x1,5	500	3000	2325	2520	95	56°	5.1	40x462	90	LV015.930W	01 02 41 42
15x1,5	500	4000	2940	2520	95	19°	5.1	40x462	90	LV015.940S	01 02 41 42
15x1,5	500	4000	2115	2520	95	33°	5.1	40x462	90	LV015.940F	01 02 41 42
15x1,5	500	4000	2325	2520	95	56°	5.1	40x462	90	LV015.940W	01 02 41 42

Da completare con alimentatore remoto -To be completed with remote driver - A completar con alimentador remoto

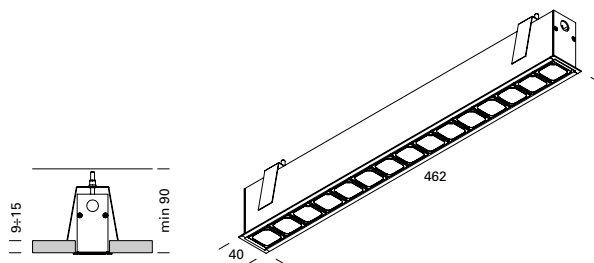

## LEVA INCASSO 5+5

DOWNLIGHTER - EMPOTRADO

UGR < 19  80x158



LED

3SDCM  
50000h L90  
B10 Ta 25°C

A+

W	mA	K	lm product	lm/Led	CRI	∠	A	Dim.	H	CODE	Col.
10x1,5	500	2700	1960	1680	95	19°	5.2	88.5x165	120	LV071.927S	01 02 41 42
10x1,5	500	2700	1410	1680	95	33°	5.2	88.5x165	120	LV071.927F	01 02 41 42
10x1,5	500	2700	1550	1680	95	56°	5.2	88.5x165	120	LV071.927W	01 02 41 42
10x1,5	500	3000	1960	1680	95	19°	5.2	88.5x165	120	LV071.930S	01 02 41 42
10x1,5	500	3000	1410	1680	95	33°	5.2	88.5x165	120	LV071.930F	01 02 41 42
10x1,5	500	3000	1550	1680	95	56°	5.2	88.5x165	120	LV071.930W	01 02 41 42
10x1,5	500	4000	1960	1680	95	19°	5.2	88.5x165	120	LV071.940S	01 02 41 42
10x1,5	500	4000	1410	1680	95	33°	5.2	88.5x165	120	LV071.940F	01 02 41 42
10x1,5	500	4000	1550	1680	95	56°	5.2	88.5x165	120	LV071.940W	01 02 41 42

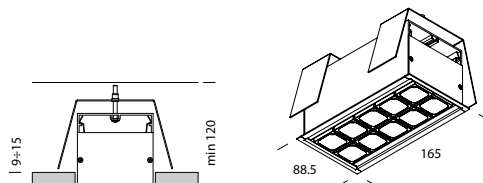

01 - telaio bianco - ottica nera - white box - black optic - marco blanco optica negra  
 41 - telaio bianco - ottica bianca - white box - white optic - marco blanco - optica blanca

02 - telaio nero - ottica nera - black box - black optic - marco negro - optica negra  
 42 - telaio nero - ottica dorata - black box - golden optic - marco negro - optica dorada

# LEVA INCASSO 10+10

DOWNLIGHTER - EMPOTRADO

UGR < 19  80x308







LED

3SDCM  
50000h L90  
B10 Ta 25°C

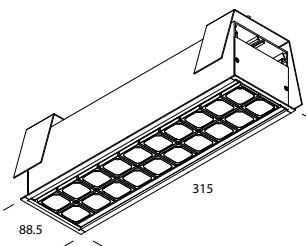
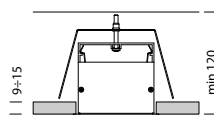
A+

W	mA	K	lm product	lm/Led	CRI	∠	A	Dim.	H	CODE	Col.
20x1,5	500	2700	3920	3360	95	19°	5.2	88.5x315	120	LV072.927S	01 02 41 42
20x1,5	500	2700	2820	3360	95	33°	5.2	88.5x315	120	LV072.927F	01 02 41 42
20x1,5	500	2700	3100	3360	95	56°	5.2	88.5x315	120	LV072.927W	01 02 41 42
20x1,5	500	3000	3920	3360	95	19°	5.2	88.5x315	120	LV072.930S	01 02 41 42
20x1,5	500	3000	2820	3360	95	33°	5.2	88.5x315	120	LV072.930F	01 02 41 42
20x1,5	500	3000	3100	3360	95	56°	5.2	88.5x315	120	LV072.930W	01 02 41 42
20x1,5	500	4000	3920	3360	95	19°	5.2	88.5x315	120	LV072.940S	01 02 41 42
20x1,5	500	4000	2820	3360	95	33°	5.2	88.5x315	120	LV072.940F	01 02 41 42
20x1,5	500	4000	3100	3360	95	56°	5.2	88.5x315	120	LV072.940W	01 02 41 42



 01 - telaio bianco - ottica nera - white box - black optic - marco blanco optica negra  
 02 - telaio nero - ottica nera - black box - black optic - marco negro - optica negra  
 41 - telaio bianco - ottica bianca - white box - white optic - marco blanco - optica blanca  
 42 - telaio nero - ottica dorata - black box - golden optic - marco negro - optica dorada



pag.824



pag.820

**LEVA INCASSO RASATO 1**

TRIMLESS DOWNLIGHTER - TOTAL EMPOTRADO

UGR < 19  34x38

LED	W	mA	K	Im product	Im/Led	CRI	∠	A	Dim.	H	CODE	Col.
3SDCM 50000h L90 B10 Ta 25°C 	1x1,5	500	2700	196	168	95	19°	5.1	32x36	100	LV001.927S	01 02 41 42
	1x1,5	500	2700	141	168	95	33°	5.1	32x36	100	LV001.927F	01 02 41 42
	1x1,5	500	2700	155	168	95	56°	5.1	32x36	100	LV001.927W	01 02 41 42
	1x1,5	500	3000	196	168	95	19°	5.1	32x36	100	LV001.930S	01 02 41 42
	1x1,5	500	3000	141	168	95	33°	5.1	32x36	100	LV001.930F	01 02 41 42
	1x1,5	500	3000	155	168	95	56°	5.1	32x36	100	LV001.930W	01 02 41 42
	1x1,5	500	4000	196	168	95	19°	5.1	32x36	100	LV001.940S	01 02 41 42
	1x1,5	500	4000	141	168	95	33°	5.1	32x36	100	LV001.940F	01 02 41 42
	1x1,5	500	4000	155	168	95	56°	5.1	32x36	100	LV001.940W	01 02 41 42

ATTENZIONE! Montaggio del prodotto prima della pendinatura del controsoffitto. | WARNING! Product Assembly before the ceiling hangers. | PRECAUCIÓN! Asamblea producto antes de las perchas de techo.

Da completare con alimentatore da installare remoto in scatola di derivazione | To be completed with power supply to be installed in a remote junction box | A ser completado con alimentador para el montaje en la caja de conexiones a distancia.

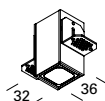
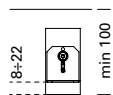
**LEVA INCASSO RASATO 3**

TRIMLESS DOWNLIGHTER - TOTAL EMPOTRADO

UGR < 19  34x98

LED	W	mA	K	Im product	Im/Led	CRI	∠	A	Dim.	H	CODE	Col.
3SDCM 50000h L90 B10 Ta 25°C 	3x1,5	500	2700	588	504	95	19°	5.1	32x96	100	LV002.927S	01 02 41 42
	3x1,5	500	2700	423	504	95	33°	5.1	32x96	100	LV002.927F	01 02 41 42
	3x1,5	500	2700	465	504	95	56°	5.1	32x96	100	LV002.927W	01 02 41 42
	3x1,5	500	3000	588	504	95	19°	5.1	32x96	100	LV002.930S	01 02 41 42
	3x1,5	500	3000	423	504	95	33°	5.1	32x96	100	LV002.930F	01 02 41 42
	3x1,5	500	3000	465	504	95	56°	5.1	32x96	100	LV002.930W	01 02 41 42
	3x1,5	500	4000	588	504	95	19°	5.1	32x96	100	LV002.940S	01 02 41 42
	3x1,5	500	4000	423	504	95	33°	5.1	32x96	100	LV002.940F	01 02 41 42
	3x1,5	500	4000	465	504	95	56°	5.1	32x96	100	LV002.940W	01 02 41 42

Da completare con alimentatore remoto - To be completed with remote driver - A completar con alimentador remoto

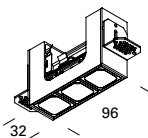
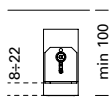

-  01 - telaio bianco - ottica nera - white box - black optic - marco blanco - optica negra  
 41 - telaio bianco - ottica bianca - white box - white optic - marco blanco - optica blanca  
 02 - telaio nero - ottica nera - black box - black optic - marco negro - optica negra  
 42 - telaio nero - ottica dorata - black box - golden optic - marco negro - optica dorada



# LEVA INCASSO RASATO 5

TRIMLESS DOWNLIGHTER - TOTAL EMPOTRADO

UGR < 16  34x158



LED

3SDCM  
50000h L90  
B10 Ta 25°C

A+

W	mA	K	lm product	lm/Led	CRI	∠	A	Dim.	H
5x1,5	500	2700	980	840	95	19°	5.1	32x156	100
5x1,5	500	2700	705	840	95	33°	5.1	32x156	100
5x1,5	500	2700	775	840	95	56°	5.1	32x156	100
5x1,5	500	3000	980	840	95	19°	5.1	32x156	100
5x1,5	500	3000	705	840	95	33°	5.1	32x156	100
5x1,5	500	3000	775	840	95	56°	5.1	32x156	100
5x1,5	500	4000	980	840	95	19°	5.1	32x156	100
5x1,5	500	4000	705	840	95	33°	5.1	32x156	100
5x1,5	500	4000	775	840	95	56°	5.1	32x156	100

CODE	Col.
LV003.927S	01 02 41 42
LV003.927F	01 02 41 42
LV003.927W	01 02 41 42
LV003.930S	01 02 41 42
LV003.930F	01 02 41 42
LV003.930W	01 02 41 42
LV003.940S	01 02 41 42
LV003.940F	01 02 41 42
LV003.940W	01 02 41 42



Da completare con alimentatore remoto -To be completed with remote driver - A completar con alimentador remoto

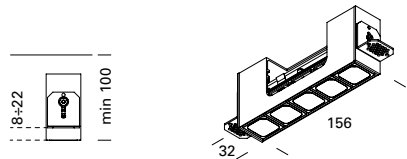

# LEVA INCASSO RASATO 10

TRIMLESS DOWNLIGHTER - TOTAL EMPOTRADO

UGR < 16  34x308



LED

3SDCM  
50000h L90  
B10 Ta 25°C

A+

W	mA	K	lm product	lm/Led	CRI	∠	A	Dim.	H
10x1,5	500	2700	1960	1680	95	19°	5.1	32x306	100
10x1,5	500	2700	1410	1680	95	33°	5.1	32x306	100
10x1,5	500	2700	1550	1680	95	56°	5.1	32x306	100
10x1,5	500	3000	1960	1680	95	19°	5.1	32x306	100
10x1,5	500	3000	1410	1680	95	33°	5.1	32x306	100
10x1,5	500	3000	1550	1680	95	56°	5.1	32x306	100
10x1,5	500	4000	1960	1680	95	19°	5.1	32x306	100
10x1,5	500	4000	1410	1680	95	33°	5.1	32x306	100
10x1,5	500	4000	1550	1680	95	56°	5.1	32x306	100

CODE	Col.
LV004.927S	01 02 41 42
LV004.927F	01 02 41 42
LV004.927W	01 02 41 42
LV004.930S	01 02 41 42
LV004.930F	01 02 41 42
LV004.930W	01 02 41 42
LV004.940S	01 02 41 42
LV004.940F	01 02 41 42
LV004.940W	01 02 41 42



Da completare con alimentatore remoto -To be completed with remote driver - A completar con alimentador remoto

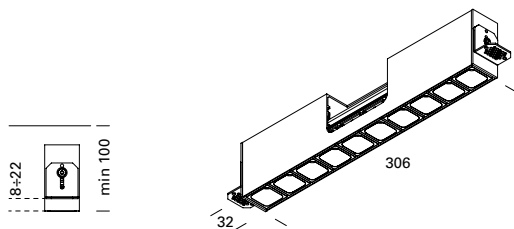

-  01 - telaio bianco - ottica nera - white box - black optic - marco blanco optica negra
-  02 - telaio nero - ottica nera - black box - black optic - marco negro - optica negra
-  41 - telaio bianco - ottica bianca - white box - white optic - marco blanco - optica blanca
-  42 - telaio nero - ottica dorata - black box - golden optic - marco negro - optica dorada

## LEVA INCASSO RASATO 15

TRIMLESS DOWNLIGHTER - TOTAL EMPOTRADO

UGR < 19  34x458



LED

W	mA	K	lm product	lm/Led	CRI	∠	A	Dim.	H
15x1,5	500	2700	2940	2520	95	19°	5.1	32x456	100
15x1,5	500	2700	2115	2520	95	33°	5.1	32x456	100
15x1,5	500	2700	2325	2520	95	56°	5.1	32x456	100
15x1,5	500	3000	2940	2520	95	19°	5.1	32x456	100
15x1,5	500	3000	2115	2520	95	33°	5.1	32x456	100
15x1,5	500	3000	2325	2520	95	56°	5.1	32x456	100
15x1,5	500	4000	2940	2520	95	19°	5.1	32x456	100
15x1,5	500	4000	2115	2520	95	33°	5.1	32x456	100
15x1,5	500	4000	2325	2520	95	56°	5.1	32x456	100

3SDCM  
50000h L90  
B10 Ta 25°C

A+

CODE	Col.
LV005.927S	01 02 41 42
LV005.927F	01 02 41 42
LV005.927W	01 02 41 42
LV005.930S	01 02 41 42
LV005.930F	01 02 41 42
LV005.930W	01 02 41 42
LV005.940S	01 02 41 42
LV005.940F	01 02 41 42
LV005.940W	01 02 41 42



Da completare con alimentatore remoto -To be completed with remote driver - A completar con alimentador remoto

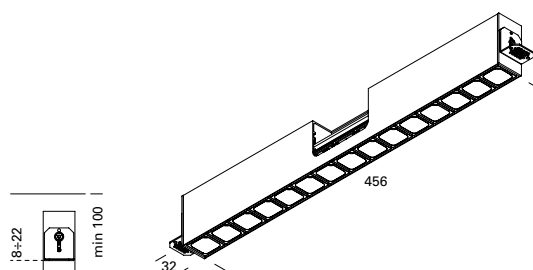

## LEVA INCASSO RASATO 5+5

TRIMLESS DOWNLIGHTER - TOTAL EMPOTRADO

UGR < 19  80x158



LED

W	mA	K	lm product	lm/Led	CRI	∠	A	Dim.	H
10x1,5	500	2700	1960	1680	95	19°	5.2	78,5x156	110
10x1,5	500	2700	1410	1680	95	33°	5.2	78,5x156	110
10x1,5	500	2700	1550	1680	95	56°	5.2	78,5x156	110
10x1,5	500	3000	1960	1680	95	19°	5.2	78,5x156	110
10x1,5	500	3000	1410	1680	95	33°	5.2	78,5x156	110
10x1,5	500	3000	1550	1680	95	56°	5.2	78,5x156	110
10x1,5	500	4000	1960	1680	95	19°	5.2	78,5x156	110
10x1,5	500	4000	1410	1680	95	33°	5.2	78,5x156	110
10x1,5	500	4000	1550	1680	95	56°	5.2	78,5x156	110

3SDCM  
50000h L90  
B10 Ta 25°C

A+

CODE	Col.
LV061.927S	01 02 41 42
LV061.927F	01 02 41 42
LV061.927W	01 02 41 42
LV061.930S	01 02 41 42
LV061.930F	01 02 41 42
LV061.930W	01 02 41 42
LV061.940S	01 02 41 42
LV061.940F	01 02 41 42
LV061.940W	01 02 41 42



Da completare con alimentatore remoto -To be completed with remote driver - A completar con alimentador remoto

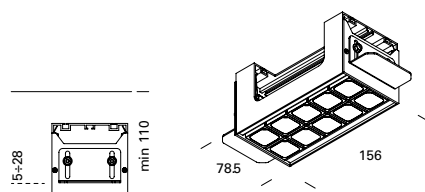

01 - telaio bianco - ottica nera - white box - black optic - marco blanco optica negra  
41 - telaio bianco - ottica bianca - white box - white optic - marco blanco - optica blanca

02 - telaio nero - ottica nera - black box - black optic - marco negro - optica negra  
42 - telaio nero - ottica dorata - black box - golden optic - marco negro - optica dorada

 pag.824

A pag.820

# LEVA INCASSO RASATO 10+10

TRIMLESS DOWNLIGHTER - TOTAL EMPOTRADO

UGR < 19  80x308



LED

3SDCM  
50000h L90  
B10 Ta 25°C

A+

W	mA	K	lm product	lm/Led	CRI	∠	A	Dim.	H
20x1,5	500	2700	3920	3360	95	19°	5.2	78,5x306	110
20x1,5	500	2700	2820	3360	95	33°	5.2	78,5x306	110
20x1,5	500	2700	3100	3360	95	56°	5.2	78,5x306	110
20x1,5	500	3000	3920	3360	95	19°	5.2	78,5x306	110
20x1,5	500	3000	2820	3360	95	33°	5.2	78,5x306	110
20x1,5	500	3000	3100	3360	95	56°	5.2	78,5x306	110
20x1,5	500	4000	3920	3360	95	19°	5.2	78,5x306	110
20x1,5	500	4000	2820	3360	95	33°	5.2	78,5x306	110
20x1,5	500	4000	3100	3360	95	56°	5.2	78,5x306	110

CODE	Col.
LV062.927S	01 02 41 42
LV062.927F	01 02 41 42
LV062.927W	01 02 41 42
LV062.930S	01 02 41 42
LV062.930F	01 02 41 42
LV062.930W	01 02 41 42
LV062.940S	01 02 41 42
LV062.940F	01 02 41 42
LV062.940W	01 02 41 42



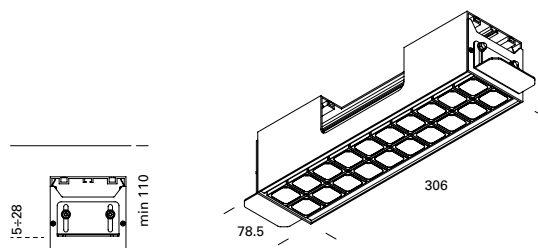

Da completare con alimentatore remoto -To be completed with remote driver - A completar con alimentador remoto



 01 - telaio bianco - ottica nera - white box - black optic - marco blanco optica negra

 02 - telaio nero - ottica nera - black box - black optic - marco negro - optica negra

 41 - telaio bianco - ottica bianca - white box - white optic - marco blanco - optica blanca

 42 - telaio nero - ottica dorata - black box - golden optic - marco negro - optica dorada

 pag.824

**A** pag.820

## INCASSO RASATO BASCULANTE 3

TILT VERSION TRIMLESS DOWNLIGHTER - VERSIÓN BASCULANTE TOTAL EMPOTRADO

UGR < 19  85x116



LED

3SDCM  
50000h L90  
B10 Ta 25°C

A+

W	K	lm product	lm/Led	CRI	△	Dim.	H
3x1,5	2700	588	504	95	19°	80x110	130+38
3x1,5	2700	423	504	95	33°	80x110	130+38
3x1,5	2700	465	504	95	56°	80x110	130+38
3x1,5	3000	588	504	95	19°	80x110	130+38
3x1,5	3000	423	504	95	33°	80x110	130+38
3x1,5	3000	465	504	95	56°	80x110	130+38
3x1,5	4000	588	504	95	19°	80x110	130+38
3x1,5	4000	423	504	95	33°	80x110	130+38
3x1,5	4000	465	504	95	56°	80x110	130+38

CODE	Col.
LV041.927S	01 02 41 42
LV041.927F	01 02 41 42
LV041.927W	01 02 41 42
LV041.930S	01 02 41 42
LV041.930F	01 02 41 42
LV041.930W	01 02 41 42
LV041.940S	01 02 41 42
LV041.940F	01 02 41 42
LV041.940W	01 02 41 42

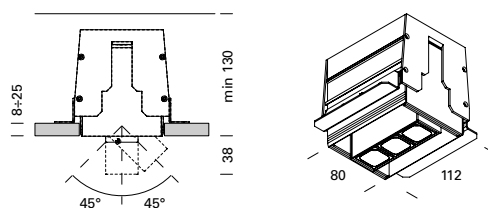

## INCASSO RASATO BASCULANTE 5

TILT VERSION TRIMLESS DOWNLIGHTER - VERSIÓN BASCULANTE TOTAL EMPOTRADO

UGR < 19  85x176



LED

3SDCM  
50000h L90  
B10 Ta 25°C

A+

W	K	lm product	lm/Led	CRI	Dali	△	Dim.	H
5x1,5	2700	980	840	95		19°	80x172	130+38
5x1,5	2700	980	840	95	x	19°	80x172	130+38
5x1,5	2700	705	840	95		33°	80x172	130+38
5x1,5	2700	705	840	95	x	33°	80x172	130+38
5x1,5	2700	775	840	95		56°	80x172	130+38
5x1,5	2700	775	840	95	x	56°	80x172	130+38
5x1,5	3000	980	840	95		19°	80x172	130+38
5x1,5	3000	980	840	95	x	19°	80x172	130+38
5x1,5	3000	705	840	95		33°	80x172	130+38
5x1,5	3000	705	840	95	x	33°	80x172	130+38
5x1,5	3000	775	840	95		56°	80x172	130+38
5x1,5	3000	775	840	95	x	56°	80x172	130+38
5x1,5	4000	980	840	95		19°	80x172	130+38
5x1,5	4000	980	840	95	x	19°	80x172	130+38
5x1,5	4000	705	840	95		33°	80x172	130+38
5x1,5	4000	705	840	95	x	33°	80x172	130+38
5x1,5	4000	775	840	95		56°	80x172	130+38
5x1,5	4000	775	840	95	x	56°	80x172	130+38

CODE	Col.
LV042.927S	01 02 41 42
LV042.927SD	01 02 41 42
LV042.927F	01 02 41 42
LV042.927FD	01 02 41 42
LV042.927W	01 02 41 42
LV042.927WD	01 02 41 42
LV042.930S	01 02 41 42
LV042.930SD	01 02 41 42
LV042.930F	01 02 41 42
LV042.930FD	01 02 41 42
LV042.930W	01 02 41 42
LV042.930WD	01 02 41 42
LV042.940S	01 02 41 42
LV042.940SD	01 02 41 42
LV042.940F	01 02 41 42
LV042.940FD	01 02 41 42
LV042.940W	01 02 41 42
LV042.940WD	01 02 41 42

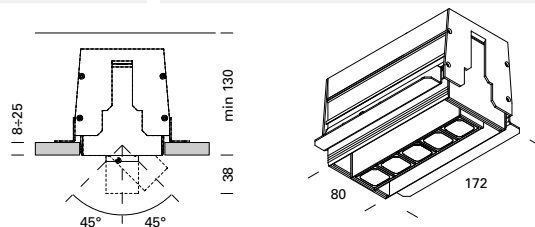

- 01 - telaio bianco - ottica nera - white box - black optic - marco blanco optica negra  
 02 - telaio nero - ottica nera - black box - black optic - marco negro - optica negra  
 41 - telaio bianco - ottica bianca - white box - white optic - marco blanco - optica blanca  
 42 - telaio nero - ottica dorata - black box - golden optic - marco negro - optica dorada



# INCASSO RASATO BASCULANTE 10

TILT VERSION TRIMLESS DOWNLIGHTER - VERSIÓN BASCULANTE TOTAL EMPOTRADO

UGR < 19  85x326



LED

3SDCM  
50000h L90  
B10 Ta 25°C

A+

W	K	Im product	Im/Led	CRI	Dali	∠	Dim.	H	CODE	Col.
10x1,5	2700	1960	1680	95		19°	80x322	130+38	LV043.927S	01 02 41 42
10x1,5	2700	1960	1680	95	x	19°	80x322	130+38	LV043.927SD	01 02 41 42
10x1,5	2700	1410	1680	95		33°	80x322	130+38	LV043.927F	01 02 41 42
10x1,5	2700	1410	1680	95	x	33°	80x322	130+38	LV043.927FD	01 02 41 42
10x1,5	2700	1550	1680	95		56°	80x322	130+38	LV043.927W	01 02 41 42
10x1,5	2700	1550	1680	95	x	56°	80x322	130+38	LV043.927WD	01 02 41 42
10x1,5	3000	1960	1680	95		19°	80x322	130+38	LV043.930S	01 02 41 42
10x1,5	3000	1960	1680	95	x	19°	80x322	130+38	LV043.930SD	01 02 41 42
10x1,5	3000	1410	1680	95		33°	80x322	130+38	LV043.930F	01 02 41 42
10x1,5	3000	1410	1680	95	x	33°	80x322	130+38	LV043.930FD	01 02 41 42
10x1,5	3000	1550	1680	95		56°	80x322	130+38	LV043.930W	01 02 41 42
10x1,5	3000	1550	1680	95	x	56°	80x322	130+38	LV043.930WD	01 02 41 42
10x1,5	4000	1960	1680	95		19°	80x322	130+38	LV043.940S	01 02 41 42
10x1,5	4000	1960	1680	95	x	19°	80x322	130+38	LV043.940SD	01 02 41 42
10x1,5	4000	1410	1680	95		33°	80x322	130+38	LV043.940F	01 02 41 42
10x1,5	4000	1410	1680	95	x	33°	80x322	130+38	LV043.940FD	01 02 41 42
10x1,5	4000	1550	1680	95		56°	80x322	130+38	LV043.940W	01 02 41 42
10x1,5	4000	1550	1680	95	x	56°	80x322	130+38	LV043.940WD	01 02 41 42

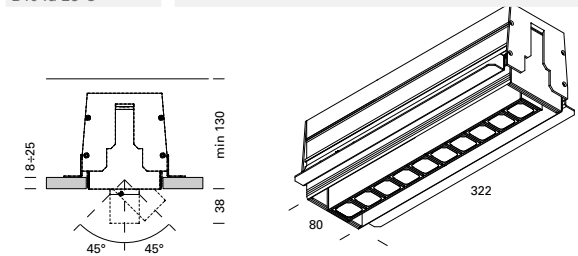

# INCASSO RASATO BASCULANTE 15

TILT VERSION TRIMLESS DOWNLIGHTER- VERSIÓN BASCULANTE TOTAL EMPOTRADO

UGR < 19  85x476

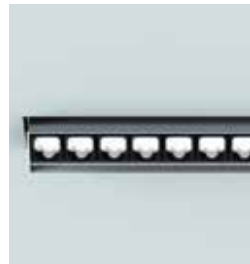

LED

3SDCM  
50000h L90  
B10 Ta 25°C

A+

W	K	Im product	Im/Led	CRI	Dali	∠	Dim.	H	CODE	Col.
15x1,5	2700	2940	2520	95		19°	80x472	130+38	LV044.927S	01 02 41 42
15x1,5	2700	2940	2520	95	x	19°	80x472	130+38	LV044.927SD	01 02 41 42
15x1,5	2700	2115	2520	95		33°	80x472	130+38	LV044.927F	01 02 41 42
15x1,5	2700	2115	2520	95	x	33°	80x472	130+38	LV044.927FD	01 02 41 42
15x1,5	2700	2325	2520	95		56°	80x472	130+38	LV044.927W	01 02 41 42
15x1,5	2700	2325	2520	95	x	56°	80x472	130+38	LV044.927WD	01 02 41 42
15x1,5	3000	2940	2520	95		19°	80x472	130+38	LV044.930S	01 02 41 42
15x1,5	3000	2940	2520	95	x	19°	80x472	130+38	LV044.930SD	01 02 41 42
15x1,5	3000	2115	2520	95		33°	80x472	130+38	LV044.930F	01 02 41 42
15x1,5	3000	2115	2520	95	x	33°	80x472	130+38	LV044.930FD	01 02 41 42
15x1,5	3000	2325	2520	95		56°	80x472	130+38	LV044.930W	01 02 41 42
15x1,5	3000	2325	2520	95	x	56°	80x472	130+38	LV044.930WD	01 02 41 42
15x1,5	4000	2940	2520	95		19°	80x472	130+38	LV044.940S	01 02 41 42
15x1,5	4000	2940	2520	95	x	19°	80x472	130+38	LV044.940SD	01 02 41 42
15x1,5	4000	2115	2520	95		33°	80x472	130+38	LV044.940F	01 02 41 42
15x1,5	4000	2115	2520	95	x	33°	80x472	130+38	LV044.940FD	01 02 41 42
15x1,5	4000	2325	2520	95		56°	80x472	130+38	LV044.940W	01 02 41 42
15x1,5	4000	2325	2520	95	x	56°	80x472	130+38	LV044.940WD	01 02 41 42

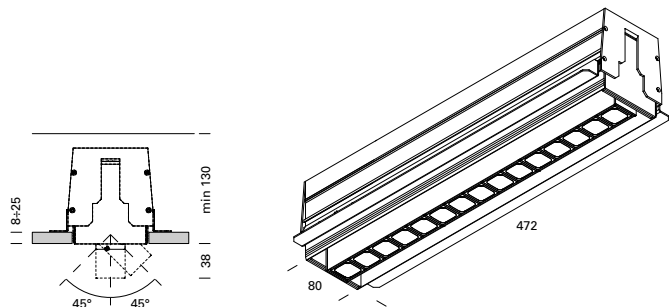

## INCASSO RASATO ROTOTRASLANTE 5

SOFT ROTATE & SLIDE MECHANISM TRIMLESS DOWNLIGHTER- VERSIÓN ROTOTRASLANTE TOTAL EMPOTRADO

UGR < 19  85x233



LED	W	mA	K	Im product	Im/Led	CRI	△	A	Dim.	H	CODE	Col.
3SDCM 50000h L90 B10 Ta 25°C	5x1,5	500	2700	980	840	95	19°	5.1	80x231	140	LV051.927S	01 02 41 42
	5x1,5	500	2700	705	840	95	33°	5.1	80x231	140	LV051.927F	01 02 41 42
	5x1,5	500	2700	775	840	95	56°	5.1	80x231	140	LV051.927W	01 02 41 42
	5x1,5	500	3000	980	840	95	19°	5.1	80x231	140	LV051.930S	01 02 41 42
	5x1,5	500	3000	705	840	95	33°	5.1	80x231	140	LV051.930F	01 02 41 42
	5x1,5	500	3000	775	840	95	56°	5.1	80x231	140	LV051.930W	01 02 41 42
	5x1,5	500	4000	980	840	95	19°	5.1	80x231	140	LV051.940S	01 02 41 42
	5x1,5	500	4000	705	840	95	33°	5.1	80x231	140	LV051.940F	01 02 41 42
	5x1,5	500	4000	775	840	95	56°	5.1	80x231	140	LV051.940W	01 02 41 42

Da completare con alimentatore remoto -To be completed with remote driver - A completar con alimentador remoto

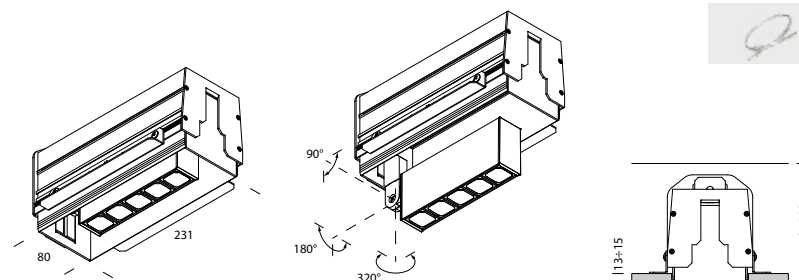

accessori -accessories -accesorios pag.71

## INCASSO RASATO ROTOTRASLANTE 10

SOFT ROTATE & SLIDE MECHANISM TRIMLESS DOWNLIGHTER- VERSIÓN ROTOTRASLANTE TOTAL EMPOTRADO

UGR < 19  85x385



LED	W	mA	K	Im product	Im/Led	CRI	△	A	Dim.	H	CODE	Col.
3SDCM 50000h L90 B10 Ta 25°C	10x1,5	500	2700	1960	1680	95	19°	5.1	80x381	140	LV052.927S	01 02 41 42
	10x1,5	500	2700	1410	1680	95	33°	5.1	80x381	140	LV052.927F	01 02 41 42
	10x1,5	500	2700	1550	1680	95	56°	5.1	80x381	140	LV052.927W	01 02 41 42
	10x1,5	500	3000	1960	1680	95	19°	5.1	80x381	140	LV052.930S	01 02 41 42
	10x1,5	500	3000	1410	1680	95	33°	5.1	80x381	140	LV052.930F	01 02 41 42
	10x1,5	500	3000	1550	1680	95	56°	5.1	80x381	140	LV052.930W	01 02 41 42
	10x1,5	500	4000	1960	1680	95	19°	5.1	80x381	140	LV052.940S	01 02 41 42
	10x1,5	500	4000	1410	1680	95	33°	5.1	80x381	140	LV052.940F	01 02 41 42
	10x1,5	500	4000	1550	1680	95	56°	5.1	80x381	140	LV052.940W	01 02 41 42

Da completare con alimentatore remoto -To be completed with remote driver - A completar con alimentador remoto

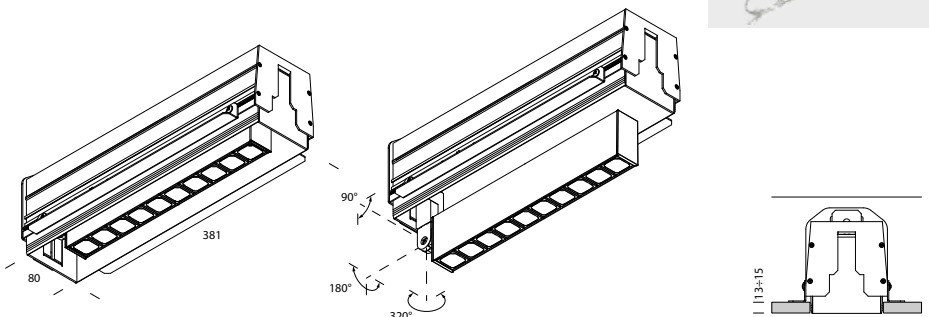

accessori -accessories -accesorios pag.71

-  01 - telaio bianco - ottica nera - white box - black optic - marco blanco optica negra
-  02 - telaio nero - ottica nera - black box - black optic - marco negro - optica negra
-  41 - telaio bianco - ottica bianca - white box - white optic - marco blanco - optica blanca
-  42 - telaio nero - ottica dorata - black box - golden optic - marco negro - optica dorada



CON LUCE INTERNA DIFFUSA - WITH INTERNAL DIFFUSED LIGHT - CON LUZ INTERNA DIFUSA

Accessori - Accessories - Accesorios

## KIT LUCE INTERNA

INTERNAL LIGHT KIT - KIT LUZ INTERNA



	W	K	lm product	lm/Led	CRI	A	CODE
LINEAR LED 18W/MT 168 LED/MT 2200LM/MT 24V	1x75	3000	924	924	>80	V.1	LVKIT5
	1x15	3000	1848	1848	>80	V.1	LVKIT10

A+



A pag.820

## LEVA SOFFITTO/PARETE 1

WALL/CEILING - PARED/TECHO

UGR < 19



LED  
3SDCM  
50000h L90  
B10 Ta 25°C  
**A+**

W	mA	K	lm product	lm/Led	CRI	△	A	Dim.	H	CODE	Col.
1x1,5	500	2700	196	168	95	19°	5.1	32x40	62	LV021.927S	01 02 41 42
1x1,5	500	2700	141	168	95	33°	5.1	32x40	62	LV021.927F	01 02 41 42
1x1,5	500	2700	155	168	95	56°	5.1	32x40	62	LV021.927W	01 02 41 42
1x1,5	500	3000	196	168	95	19°	5.1	32x40	62	LV021.930S	01 02 41 42
1x1,5	500	3000	141	168	95	33°	5.1	32x40	62	LV021.930F	01 02 41 42
1x1,5	500	3000	155	168	95	56°	5.1	32x40	62	LV021.930W	01 02 41 42
1x1,5	500	4000	196	168	95	19°	5.1	32x40	62	LV021.940S	01 02 41 42
1x1,5	500	4000	141	168	95	33°	5.1	32x40	62	LV021.940F	01 02 41 42
1x1,5	500	4000	155	168	95	56°	5.1	32x40	62	LV021.940W	01 02 41 42

Da completare con alimentatore da installare remoto in scatola di derivazione | To be completed with power supply to be installed in a remote junction box | A ser completado con alimentador para el montaje en la caja de conexiones a distancia.

Per installazione in Container Minifile ordinare n.2 LTM210 staffa per fissaggio modulo luminoso all'interno della cassaforma. | To put it in Container Minifile order n.2 LTM210 single bracket to fix the lighting module within the wallbox. | Para instalarlo nel Container Minifile ordenar n.2 LTM210 soporte individual por fijar el encofrado.

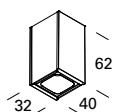

## LEVA SOFFITTO/PARETE 3

WALL/CEILING - PARED/TECHO

UGR < 19



LED  
3SDCM  
50000h L90  
B10 Ta 25°C  
**A+**

W	K	lm product	lm/Led	CRI	△	Dim.	H	CODE	Col.
3x1,5	2700	588	504	95	19°	32x100	62	LV022.927S	01 02 41 42
3x1,5	2700	423	504	95	33°	32x100	62	LV022.927F	01 02 41 42
3x1,5	2700	465	504	95	56°	32x100	62	LV022.927W	01 02 41 42
3x1,5	3000	588	504	95	19°	32x100	62	LV022.930S	01 02 41 42
3x1,5	3000	423	504	95	33°	32x100	62	LV022.930F	01 02 41 42
3x1,5	3000	465	504	95	56°	32x100	62	LV022.930W	01 02 41 42
3x1,5	4000	588	504	95	19°	32x100	62	LV022.940S	01 02 41 42
3x1,5	4000	423	504	95	33°	32x100	62	LV022.940F	01 02 41 42
3x1,5	4000	465	504	95	56°	32x100	62	LV022.940W	01 02 41 42

Per installazione in Container Minifile ordinare n.2 LTM210 staffa per fissaggio modulo luminoso all'interno della cassaforma. | To put it in Container Minifile order n.2 LTM210 single bracket to fix the lighting module within the wallbox. | Para instalarlo nel Container Minifile ordenar n.2 LTM210 soporte individual por fijar el encofrado.

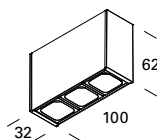

01 - telaio bianco - ottica nera - white box - black optic - marco blanco optica negra

02 - telaio nero - ottica nera - black box - black optic - marco negro - optica negra

41 - telaio bianco - ottica bianca - white box - white optic - marco blanco - optica blanca

42 - telaio nero - ottica dorata - black box - golden optic - marco negro - optica dorada



## LEVA SOFFITTO/PARETE 5

WALL/CEILING - PARED/TECHO

UGR < 19



LED	W	K	lm product	lm/Led	CRI	∠	Dim.	H	CODE	Col.
3SDCM 50000h L90 B10 Ta 25°C	5x1,5	2700	980	840	95	19°	32x160	62	LV023.927S	01 02 41 42
	5x1,5	2700	705	840	95	33°	32x160	62	LV023.927F	01 02 41 42
	5x1,5	2700	775	840	95	56°	32x160	62	LV023.927W	01 02 41 42
	5x1,5	3000	980	840	95	19°	32x160	62	LV023.930S	01 02 41 42
	5x1,5	3000	705	840	95	33°	32x160	62	LV023.930F	01 02 41 42
	5x1,5	3000	775	840	95	56°	32x160	62	LV023.930W	01 02 41 42
	5x1,5	4000	980	840	95	19°	32x160	62	LV023.940S	01 02 41 42
	5x1,5	4000	705	840	95	33°	32x160	62	LV023.940F	01 02 41 42
	5x1,5	4000	775	840	95	56°	32x160	62	LV023.940W	01 02 41 42

A+



Per installazione in Container Minifile ordinare n.2 LTM210 staffa per fissaggio modulo luminoso all'interno della cassaforma. | To put it in Container Minifile order n.2 LTM210 single bracket to fix the lighting module within the wallbox. | Para instalarlo nel Container Minifile ordenar n.2 LTM210 soporte individual por fijar el encofrado.

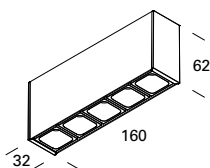

## LEVA SOFFITTO/PARETE 10

WALL/CEILING - PARED/TECHO

UGR < 19



LED	W	K	lm product	lm/Led	CRI	∠	Dim.	H	CODE	Col.
3SDCM 50000h L90 B10 Ta 25°C	10x1,5	2700	1960	1680	95	19°	32x310	62	LV024.927S	01 02 41 42
	10x1,5	2700	1410	1680	95	33°	32x310	62	LV024.927F	01 02 41 42
	10x1,5	2700	1550	1680	95	56°	32x310	62	LV024.927W	01 02 41 42
	10x1,5	3000	1960	1680	95	19°	32x310	62	LV024.930S	01 02 41 42
	10x1,5	3000	1410	1680	95	33°	32x310	62	LV024.930F	01 02 41 42
	10x1,5	3000	1550	1680	95	56°	32x310	62	LV024.930W	01 02 41 42
	10x1,5	4000	1960	1680	95	19°	32x310	62	LV024.940S	01 02 41 42
	10x1,5	4000	1410	1680	95	33°	32x310	62	LV024.940F	01 02 41 42
	10x1,5	4000	1550	1680	95	56°	32x310	62	LV024.940W	01 02 41 42

A+



Per installazione in Container Minifile ordinare n.2 LTM210 staffa per fissaggio modulo luminoso all'interno della cassaforma. | To put it in Container Minifile order n.2 LTM210 single bracket to fix the lighting module within the wallbox. | Para instalarlo nel Container Minifile ordenar n.2 LTM210 soporte individual por fijar el encofrado.

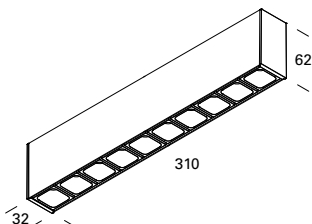

01 - telaio bianco - ottica nera - white box - black optic - marco blanco optica negra

02 - telaio nero - ottica nera - black box - black optic - marco negro - optica negra

41 - telaio bianco - ottica bianca - white box - white optic - marco blanco - optica blanca

42 - telaio nero - ottica dorata - black box - golden optic - marco negro - optica dorada



pag.824

## LEVA SOFFITTO/PARETE 15

WALL/CEILING - PARED/TECHO

UGR < 19



LED	W	K	lm product	lm/Led	CRI	∠	Dim.	H	CODE	Col.
3SDCM 50000h L90 B10 Ta 25°C	15x1,5	2700	2940	2520	95	19°	32x460	62	LV025.927S	01 02 41 42
	15x1,5	2700	2115	2520	95	33°	32x460	62	LV025.927F	01 02 41 42
	15x1,5	2700	2325	2520	95	56°	32x460	62	LV025.927W	01 02 41 42
	15x1,5	3000	2940	2520	95	19°	32x460	62	LV025.930S	01 02 41 42
	15x1,5	3000	2115	2520	95	33°	32x460	62	LV025.930F	01 02 41 42
	15x1,5	3000	2325	2520	95	56°	32x460	62	LV025.930W	01 02 41 42
	15x1,5	4000	2940	2520	95	19°	32x460	62	LV025.940S	01 02 41 42
	15x1,5	4000	2115	2520	95	33°	32x460	62	LV025.940F	01 02 41 42
	15x1,5	4000	2325	2520	95	56°	32x460	62	LV025.940W	01 02 41 42

Per installazione in Container Minifile ordinare n.2 LTM210 staffa per fissaggio modulo luminoso all'interno della cassaforma. | To put it in Container Minifile order n.2 LTM210 single bracket to fix the lighting module within the wallbox. | Para instalarlo nel Container Minifile ordenar n.2 LTM210 soporte individual por fijar el encofrado.

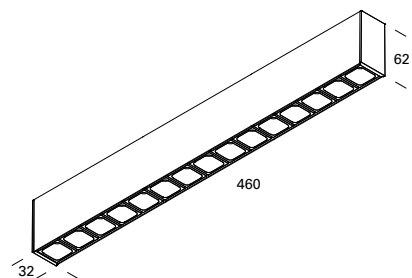

## LEVA SOFFITTO/PARETE 5+5

WALL/CEILING - PARED/TECHO

UGR < 19



LED	W	K	lm product	lm/Led	CRI	Dali	∠	Dim.	H	CODE	Col.
3SDCM 50000h L90 B10 Ta 25°C	10x1,5	2700	1960	1680	95		19°	78.5x160	75	LV081.927S	01 02 41 42
	10x1,5	2700	1960	1680	95	x	19°	78.5x160	75	LV081.927SD	01 02 41 42
	10x1,5	2700	1410	1680	95		33°	78.5x160	75	LV081.927F	01 02 41 42
	10x1,5	2700	1410	1680	95	x	33°	78.5x160	75	LV081.927FD	01 02 41 42
	10x1,5	2700	1550	1680	95		56°	78.5x160	75	LV081.927W	01 02 41 42
	10x1,5	2700	1550	1680	95	x	56°	78.5x160	75	LV081.927WD	01 02 41 42
	10x1,5	3000	1960	1680	95		19°	78.5x160	75	LV081.930S	01 02 41 42
	10x1,5	3000	1960	1680	95	x	19°	78.5x160	75	LV081.930SD	01 02 41 42
	10x1,5	3000	1410	1680	95		33°	78.5x160	75	LV081.930F	01 02 41 42
	10x1,5	3000	1410	1680	95	x	33°	78.5x160	75	LV081.930FD	01 02 41 42
	10x1,5	3000	1550	1680	95		56°	78.5x160	75	LV081.930W	01 02 41 42
	10x1,5	3000	1550	1680	95	x	56°	78.5x160	75	LV081.930WD	01 02 41 42
	10x1,5	4000	1960	1680	95		19°	78.5x160	75	LV081.940S	01 02 41 42
	10x1,5	4000	1960	1680	95	x	19°	78.5x160	75	LV081.940SD	01 02 41 42
	10x1,5	4000	1410	1680	95		33°	78.5x160	75	LV081.940F	01 02 41 42
	10x1,5	4000	1410	1680	95	x	33°	78.5x160	75	LV081.940FD	01 02 41 42
	10x1,5	4000	1550	1680	95		56°	78.5x160	75	LV081.940W	01 02 41 42
	10x1,5	4000	1550	1680	95	x	56°	78.5x160	75	LV081.940WD	01 02 41 42

Per installazione in Container File2 ordinare n.2 LT2891 staffa per fissaggio modulo luminoso all'interno della cassaforma. | To put it in Container File2 order n.2 LT2891 single bracket to fix the lighting module within the wallbox. | Para instalarlo nel Container File2 ordenar n.2 LT2891 soporte individual por fijar el encofrado.

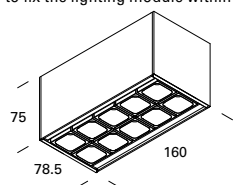

- - 
  -
- 01 - telaio bianco - ottica nera - white box - black optic - marco blanco optica negra  
 02 - telaio nero - ottica nera - black box - black optic - marco negro - optica negra  
 41 - telaio bianco - ottica bianca - white box - white optic - marco blanco - optica blanca  
 42 - telaio nero - ottica dorata - black box - golden optic - marco negro - optica dorada

# LEVA SOFFITTO/PARETE 10+10

WALL/CEILING - PARED/TECHO

UGR < 19



LED

3SDCM  
50000h L90  
B10 Ta 25°C

A+

W	K	Im product	Im/Led	CRI	Dali	∠	Dim.	H	CODE	Col.
20x1,5	2700	3920	3360	95		19°	78.5x310	75	LV082.927S	01 02 41 42
20x1,5	2700	3920	3360	95	x	19°	78.5x310	75	LV082.927SD	01 02 41 42
20x1,5	2700	2820	3360	95		33°	78.5x310	75	LV082.927F	01 02 41 42
20x1,5	2700	2820	3360	95	x	33°	78.5x310	75	LV082.927FD	01 02 41 42
20x1,5	2700	3100	3360	95		56°	78.5x310	75	LV082.927W	01 02 41 42
20x1,5	2700	3100	3360	95	x	56°	78.5x310	75	LV082.927WD	01 02 41 42
20x1,5	3000	3920	3360	95		19°	78.5x310	75	LV082.930S	01 02 41 42
20x1,5	3000	3920	3360	95	x	19°	78.5x310	75	LV082.930SD	01 02 41 42
20x1,5	3000	2820	3360	95		33°	78.5x310	75	LV082.930F	01 02 41 42
20x1,5	3000	2820	3360	95	x	33°	78.5x310	75	LV082.930FD	01 02 41 42
20x1,5	3000	3100	3360	95		56°	78.5x310	75	LV082.930W	01 02 41 42
20x1,5	3000	3100	3360	95	x	56°	78.5x310	75	LV082.930WD	01 02 41 42
20x1,5	4000	3920	3360	95		19°	78.5x310	75	LV082.940S	01 02 41 42
20x1,5	4000	3920	3360	95	x	19°	78.5x310	75	LV082.940SD	01 02 41 42
20x1,5	4000	2820	3360	95		33°	78.5x310	75	LV082.940F	01 02 41 42
20x1,5	4000	2820	3360	95	x	33°	78.5x310	75	LV082.940FD	01 02 41 42
20x1,5	4000	3100	3360	95		56°	78.5x310	75	LV082.940W	01 02 41 42
20x1,5	4000	3100	3360	95	x	56°	78.5x310	75	LV082.940WD	01 02 41 42



Per installazione in Container File2 ordinare n.2 LT2891 staffa per fissaggio modulo luminoso all'interno della cassaforma. | To put it in Container File2 order n.2 LT2891 single bracket to fix the lighting module within the wallbox. | Para instalarlo nel Container File2 ordenar n.2 LT2891 soportes individual por fijar el encofrado.

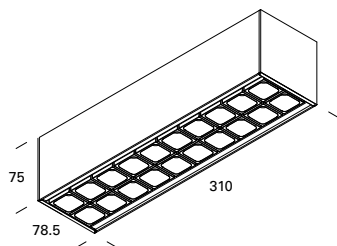

- 01 - telaio bianco - ottica nera - white box - black optic - marco blanco optica negra
- 02 - telaio nero - ottica nera - black box - black optic - marco negro - optica negra
- 41 - telaio bianco - ottica bianca - white box - white optic - marco blanco - optica blanca
- 42 - telaio nero - ottica dorata - black box - golden optic - marco negro - optica dorada

## LEVA SOFFITTO/PARETE ROTO-TRASLANTE 5

WALL/CEILING SOFT ROTATE & SLIDE VERSION - PARED/TECHO VERSIÓN ROTOTRASLANTE

UGR < 19

LED	W	K	lm			Dali	∠	CODE	Col.
			product	lm/Led	CRI				
	5x1,5	2700	980	840	95		19°	LV032.927S	01 02 41 42
	5x1,5	2700	980	840	95	x	19°	LV032.927SD	01 02 41 42
	5x1,5	2700	705	840	95		33°	LV032.927F	01 02 41 42
	5x1,5	2700	705	840	95	x	33°	LV032.927FD	01 02 41 42
	5x1,5	2700	775	840	95		56°	LV032.927W	01 02 41 42
	5x1,5	2700	775	840	95	x	56°	LV032.927WD	01 02 41 42
	5x1,5	3000	980	840	95		19°	LV032.930S	01 02 41 42
	5x1,5	3000	980	840	95	x	19°	LV032.930SD	01 02 41 42
	5x1,5	3000	705	840	95		33°	LV032.930F	01 02 41 42
	5x1,5	3000	705	840	95	x	33°	LV032.930FD	01 02 41 42
	5x1,5	3000	775	840	95		56°	LV032.930W	01 02 41 42
	5x1,5	3000	775	840	95	x	56°	LV032.930WD	01 02 41 42
	5x1,5	4000	980	840	95		19°	LV032.940S	01 02 41 42
	5x1,5	4000	980	840	95	x	19°	LV032.940SD	01 02 41 42
	5x1,5	4000	705	840	95		33°	LV032.940F	01 02 41 42
	5x1,5	4000	705	840	95	x	33°	LV032.940FD	01 02 41 42
	5x1,5	4000	775	840	95		56°	LV032.940W	01 02 41 42
	5x1,5	4000	775	840	95	x	56°	LV032.940WD	01 02 41 42

3SDCM  
50000h L90  
B10 Ta 25°C

A+



Per installazione in Container Minifile ordinare n.1 LVKL01 staffa per fissaggio modulo luminoso all'interno della cassaforma. | To put it in Container Minifile order n.1 LVKL01 single bracket to fix the lighting module within the wallbox. | Para instalarlo nel Container Minifile ordenar n.1 LVKL01 soporte individual por fijar el encofrado.

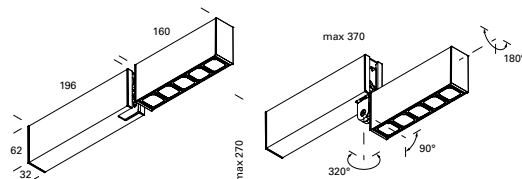

## LEVA SOFFITTO/PARETE ROTO-TRASLANTE 10

WALL/CEILING SOFT ROTATE & SLIDE VERSION - PARED/TECHO VERSIÓN ROTOTRASLANTE

UGR < 19

LED	W	K	lm			Dali	∠	CODE	Col.
			product	lm/Led	CRI				
	10x1,5	2700	1960	1680	95		19°	LV033.927S	01 02 41 42
	10x1,5	2700	1960	1680	95	x	19°	LV033.927SD	01 02 41 42
	10x1,5	2700	1410	1680	95		33°	LV033.927F	01 02 41 42
	10x1,5	2700	1410	1680	95	x	33°	LV033.927FD	01 02 41 42
	10x1,5	2700	1550	1680	95		56°	LV033.927W	01 02 41 42
	10x1,5	2700	1550	1680	95	x	56°	LV033.927WD	01 02 41 42
	10x1,5	3000	1960	1680	95		19°	LV033.930S	01 02 41 42
	10x1,5	3000	1960	1680	95	x	19°	LV033.930SD	01 02 41 42
	10x1,5	3000	1410	1680	95		33°	LV033.930F	01 02 41 42
	10x1,5	3000	1410	1680	95	x	33°	LV033.930FD	01 02 41 42
	10x1,5	3000	1550	1680	95		56°	LV033.930W	01 02 41 42
	10x1,5	3000	1550	1680	95	x	56°	LV033.930WD	01 02 41 42
	10x1,5	4000	1960	1680	95		19°	LV033.940S	01 02 41 42
	10x1,5	4000	1960	1680	95	x	19°	LV033.940SD	01 02 41 42
	10x1,5	4000	1410	1680	95		33°	LV033.940F	01 02 41 42
	10x1,5	4000	1410	1680	95	x	33°	LV033.940FD	01 02 41 42
	10x1,5	4000	1550	1680	95		56°	LV033.940W	01 02 41 42
	10x1,5	4000	1550	1680	95	x	56°	LV033.940WD	01 02 41 42

3SDCM  
50000h L90  
B10 Ta 25°C

A+



Per installazione in Container Minifile ordinare n.1 LVKL01 staffa per fissaggio modulo luminoso all'interno della cassaforma. | To put it in Container Minifile order n.1 LVKL01 single bracket to fix the lighting module within the wallbox. | Para instalarlo nel Container Minifile ordenar n.1 LVKL01 soporte individual por fijar el encofrado.

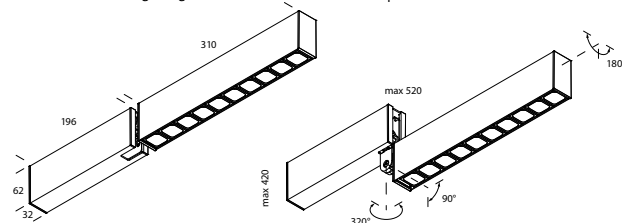

- 01 - telaio bianco - ottica nera - white box - black optic - marco blanco optica negra
- 02 - telaio nero - ottica nera - black box - black optic - marco negro - optica negra
- 41 - telaio bianco - ottica bianca - white box - white optic - marco blanco - optica blanca
- 42 - telaio nero - ottica dorata - black box - golden optic - marco negro - optica dorada



## LEVA BINARIO 5

TRACK VERSION - VERSIÓN CARRIL

UGR < 19

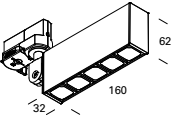
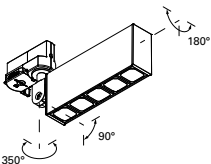
	W	K	lm product	lm/Led	CRI	△	Dim.	H	CODE	Col.
 <p>LED</p> <p>3SDCM 50000h L90 B10 Ta 25°C</p> <p><b>A+</b></p>	5x1,5	2700	980	840	95	19°	32x160	62	LV201.927S	01 02 41 42
	5x1,5	2700	705	840	95	33°	32x160	62	LV201.927F	01 02 41 42
	5x1,5	2700	775	840	95	56°	32x160	62	LV201.927W	01 02 41 42
	5x1,5	3000	980	840	95	19°	32x160	62	LV201.930S	01 02 41 42
	5x1,5	3000	705	840	95	33°	32x160	62	LV201.930F	01 02 41 42
	5x1,5	3000	775	840	95	56°	32x160	62	LV201.930W	01 02 41 42
	5x1,5	4000	980	840	95	19°	32x160	62	LV201.940S	01 02 41 42
	5x1,5	4000	705	840	95	33°	32x160	62	LV201.940F	01 02 41 42
	5x1,5	4000	775	840	95	56°	32x160	62	LV201.940W	01 02 41 42
										



## LEVA BINARIO 10

TRACK VERSION - VERSIÓN CARRIL

UGR < 19

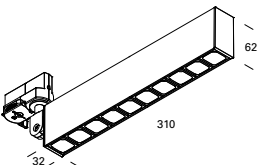
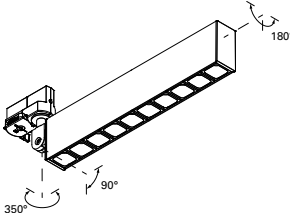
	W	K	lm product	lm/Led	CRI	△	Dim.	H	CODE	Col.
 <p>LED</p> <p>3SDCM 50000h L90 B10 Ta 25°C</p> <p><b>A+</b></p>	10x1,5	2700	1960	1680	95	19°	32x310	62	LV202.927S	01 02 41 42
	10x1,5	2700	1410	1680	95	33°	32x310	62	LV202.927F	01 02 41 42
	10x1,5	2700	1550	1680	95	56°	32x310	62	LV202.927W	01 02 41 42
	10x1,5	3000	1960	1680	95	19°	32x310	62	LV202.930S	01 02 41 42
	10x1,5	3000	1410	1680	95	33°	32x310	62	LV202.930F	01 02 41 42
	10x1,5	3000	1550	1680	95	56°	32x310	62	LV202.930W	01 02 41 42
	10x1,5	4000	1960	1680	95	19°	32x310	62	LV202.940S	01 02 41 42
	10x1,5	4000	1410	1680	95	33°	32x310	62	LV202.940F	01 02 41 42
	10x1,5	4000	1550	1680	95	56°	32x310	62	LV202.940W	01 02 41 42
										



- 01 - telaio bianco - ottica nera - white box - black optic - marco blanco optica negra  
02 - telaio nero - ottica nera - black box - black optic - marco negro - optica negra  
41 - telaio bianco - ottica bianca - white box - white optic - marco blanco - optica blanca  
42 - telaio nero - ottica dorata - black box - golden optic - marco negro - optica dorada

# LEVA BINARIO 5+5

TRACK VERSION - VERSIÓN CARRIL

UGR < 19



LED

3SDCM  
50000h L90  
B10 Ta 25°C

A+

W	K	lm product	lm/Led	CRI	Dali	∠	Dim.	H	CODE	Col.
10x1,5	2700	1960	1680	95		19°	78.5x160	75	LV203.927S	01 02 41 42
10x1,5	2700	1960	1680	95	x	19°	78.5x160	75	LV203.927SD	01 02 41 42
10x1,5	2700	1410	1680	95		33°	78.5x160	75	LV203.927F	01 02 41 42
10x1,5	2700	1410	1680	95	x	33°	78.5x160	75	LV203.927FD	01 02 41 42
10x1,5	2700	1550	1680	95		56°	78.5x160	75	LV203.927W	01 02 41 42
10x1,5	2700	1550	1680	95	x	56°	78.5x160	75	LV203.927WD	01 02 41 42
10x1,5	3000	1960	1680	95		19°	78.5x160	75	LV203.930S	01 02 41 42
10x1,5	3000	1960	1680	95	x	19°	78.5x160	75	LV203.930SD	01 02 41 42
10x1,5	3000	1410	1680	95		33°	78.5x160	75	LV203.930F	01 02 41 42
10x1,5	3000	1410	1680	95	x	33°	78.5x160	75	LV203.930FD	01 02 41 42
10x1,5	3000	1550	1680	95		56°	78.5x160	75	LV203.930W	01 02 41 42
10x1,5	3000	1550	1680	95	x	56°	78.5x160	75	LV203.930WD	01 02 41 42
10x1,5	4000	1960	1680	95		19°	78.5x160	75	LV203.940S	01 02 41 42
10x1,5	4000	1960	1680	95	x	19°	78.5x160	75	LV203.940SD	01 02 41 42
10x1,5	4000	1410	1680	95		33°	78.5x160	75	LV203.940F	01 02 41 42
10x1,5	4000	1410	1680	95	x	33°	78.5x160	75	LV203.940FD	01 02 41 42
10x1,5	4000	1550	1680	95		56°	78.5x160	75	LV203.940W	01 02 41 42
10x1,5	4000	1550	1680	95	x	56°	78.5x160	75	LV203.940WD	01 02 41 42

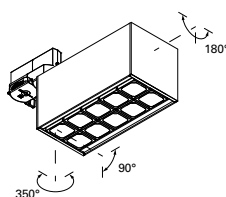
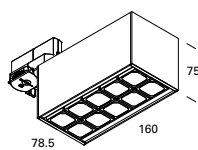

- 
- 01 - telaio bianco - ottica nera - white box - black optic - marco blanco optica negra
  02 - telaio nero - ottica nera - black box - black optic - marco negro - optica negra
- 41 - telaio bianco - ottica bianca - white box - white optic - marco blanco - optica blanca
  42 - telaio nero - ottica dorata - black box - golden optic - marco negro - optica dorada



pag.824

PROFILO CONTAINER FILE2





## LEVA SISTEMA

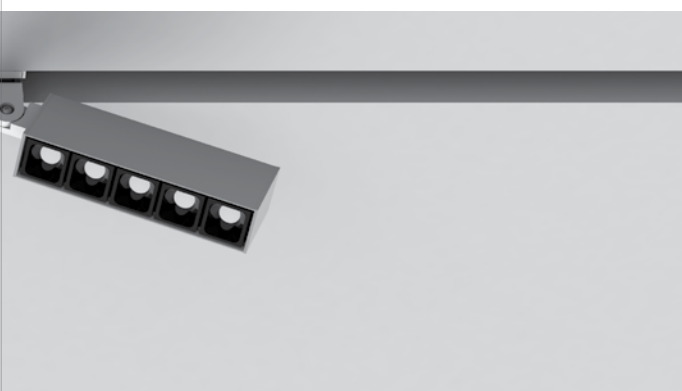
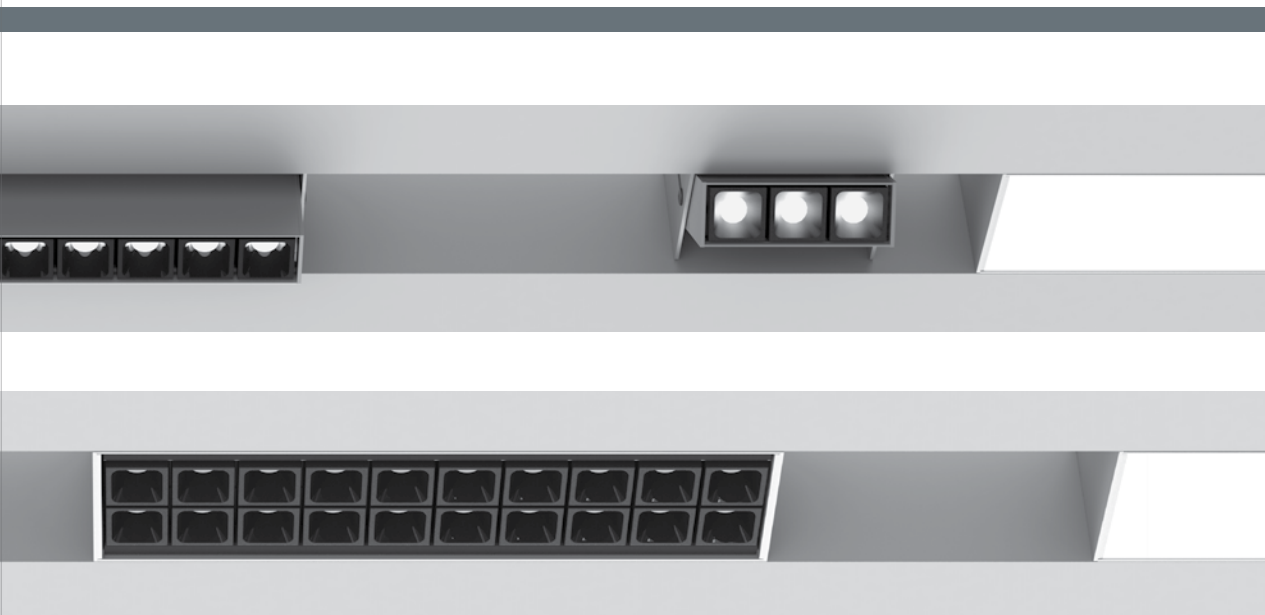

□ PROFILO CONTAINER MINIFILE







**MODULO 3 PER/FOR/POR MINIFILE SYSTEM**

3 LAMPS TRIMLESS MODULE - MODULO TOTAL EMPOTRABLE 3 LAMPARAS

UGR &lt; 19

LED	W	K	lm product	lm/Led	CRI	Dali	∠	Dim.	CODE	Col.
	3x1,5	2700	588	504	95		19°	275x240	LV102.927S	01 02 41 42
	3x1,5	2700	588	504	95	x	19°	275x240	LV102.927SD	01 02 41 42
	3x1,5	2700	423	504	95		33°	275x240	LV102.927F	01 02 41 42
	3x1,5	2700	423	504	95	x	33°	275x240	LV102.927FD	01 02 41 42
	3x1,5	2700	465	504	95		56°	275x240	LV102.927W	01 02 41 42
	3x1,5	2700	465	504	95	x	56°	275x240	LV102.927WD	01 02 41 42
	3x1,5	3000	588	504	95		19°	275x240	LV102.930S	01 02 41 42
	3x1,5	3000	588	504	95	x	19°	275x240	LV102.930SD	01 02 41 42
	3x1,5	3000	423	504	95		33°	275x240	LV102.930F	01 02 41 42
	3x1,5	3000	423	504	95	x	33°	275x240	LV102.930FD	01 02 41 42
	3x1,5	3000	465	504	95		56°	275x240	LV102.930W	01 02 41 42
	3x1,5	3000	465	504	95	x	56°	275x240	LV102.930WD	01 02 41 42
	3x1,5	4000	588	504	95		19°	275x240	LV102.940S	01 02 41 42
	3x1,5	4000	588	504	95	x	19°	275x240	LV102.940SD	01 02 41 42
	3x1,5	4000	423	504	95		33°	275x240	LV102.940F	01 02 41 42
	3x1,5	4000	423	504	95	x	33°	275x240	LV102.940FD	01 02 41 42
	3x1,5	4000	465	504	95		56°	275x240	LV102.940W	01 02 41 42
	3x1,5	4000	465	504	95	x	56°	275x240	LV102.940WD	01 02 41 42

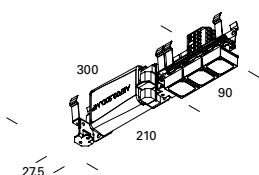
**MODULO 5 PER/FOR/POR MINIFILE SYSTEM**

5 LAMPS TRIMLESS MODULE - MODULO TOTAL EMPOTRABLE 5 LAMPARAS

UGR &lt; 19

LED	W	K	lm product	lm/Led	CRI	Dali	∠	Dim.	CODE	Col.
	5x1,5	2700	980	840	95		19°	275x300	LV103.927S	01 02 41 42
	5x1,5	2700	980	840	95	x	19°	275x300	LV103.927SD	01 02 41 42
	5x1,5	2700	705	840	95		33°	275x300	LV103.927F	01 02 41 42
	5x1,5	2700	705	840	95	x	33°	275x300	LV103.927FD	01 02 41 42
	5x1,5	2700	775	840	95		56°	275x300	LV103.927W	01 02 41 42
	5x1,5	2700	775	840	95	x	56°	275x300	LV103.927WD	01 02 41 42
	5x1,5	3000	980	840	95		19°	275x300	LV103.930S	01 02 41 42
	5x1,5	3000	980	840	95	x	19°	275x300	LV103.930SD	01 02 41 42
	5x1,5	3000	705	840	95		33°	275x300	LV103.930F	01 02 41 42
	5x1,5	3000	705	840	95	x	33°	275x300	LV103.930FD	01 02 41 42
	5x1,5	3000	775	840	95		56°	275x300	LV103.930W	01 02 41 42
	5x1,5	3000	775	840	95	x	56°	275x300	LV103.930WD	01 02 41 42
	5x1,5	4000	980	840	95		19°	275x300	LV103.940S	01 02 41 42
	5x1,5	4000	980	840	95	x	19°	275x300	LV103.940SD	01 02 41 42
	5x1,5	4000	705	840	95		33°	275x300	LV103.940F	01 02 41 42
	5x1,5	4000	705	840	95	x	33°	275x300	LV103.940FD	01 02 41 42
	5x1,5	4000	775	840	95		56°	275x300	LV103.940W	01 02 41 42
	5x1,5	4000	775	840	95	x	56°	275x300	LV103.940WD	01 02 41 42

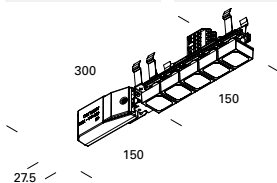

- 01 - telaio bianco - ottica nera - white box - black optic - marco blanco optica negra  
■ 02 - telaio nero - ottica nera - black box - black optic - marco negro - optica negra  
□ 41 - telaio bianco - ottica bianca - white box - white optic - marco blanco - optica blanca  
■ 42 - telaio nero - ottica dorata - black box - golden optic - marco negro - optica dorada



## MODULO 10 PER/FOR/POR MINIFILE SYSTEM

10 LAMPS TRIMLESS MODULE - MODULO TOTAL EMPOTRABLE 10 LAMPARAS

UGR < 19

LED	W	K	lm product	lm/Led	CRI	Dali	∠	Dim.	CODE	Col.
	10x1,5	2700	1960	1680	95		19°	275x450	LV104.927S	01 02 41 42
	10x1,5	2700	1960	1680	95	x	19°	275x450	LV104.927SD	01 02 41 42
	10x1,5	2700	1410	1680	95		33°	275x450	LV104.927F	01 02 41 42
	10x1,5	2700	1410	1680	95	x	33°	275x450	LV104.927FD	01 02 41 42
	10x1,5	2700	1550	1680	95		56°	275x450	LV104.927W	01 02 41 42
	10x1,5	2700	1550	1680	95	x	56°	275x450	LV104.927WD	01 02 41 42
	10x1,5	3000	1960	1680	95		19°	275x450	LV104.930S	01 02 41 42
	10x1,5	3000	1960	1680	95	x	19°	275x450	LV104.930SD	01 02 41 42
	10x1,5	3000	1410	1680	95		33°	275x450	LV104.930F	01 02 41 42
	10x1,5	3000	1410	1680	95	x	33°	275x450	LV104.930FD	01 02 41 42
	10x1,5	3000	1550	1680	95		56°	275x450	LV104.930W	01 02 41 42
	10x1,5	3000	1550	1680	95	x	56°	275x450	LV104.930WD	01 02 41 42
	10x1,5	4000	1960	1680	95		19°	275x450	LV104.940S	01 02 41 42
	10x1,5	4000	1960	1680	95	x	19°	275x450	LV104.940SD	01 02 41 42
	10x1,5	4000	1410	1680	95		33°	275x450	LV104.940F	01 02 41 42
	10x1,5	4000	1410	1680	95	x	33°	275x450	LV104.940FD	01 02 41 42
	10x1,5	4000	1550	1680	95		56°	275x450	LV104.940W	01 02 41 42
	10x1,5	4000	1550	1680	95	x	56°	275x450	LV104.940WD	01 02 41 42

3SDCM  
50000h L90  
B10 Ta 25°C

**A+**

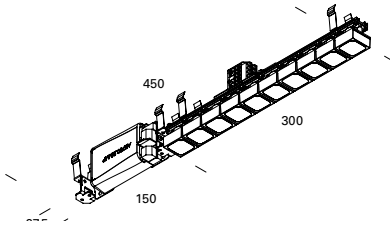

## MODULO 15 PER/FOR/POR MINIFILE SYSTEM

15 LAMPS TRIMLESS MODULE - MODULO TOTAL EMPOTRABLE 15 LAMPARAS

UGR < 19

LED	W	K	lm product	lm/Led	CRI	Dali	∠	Dim.	CODE	Col.
	15x1,5	2700	2940	2520	95		10°	275x750	LV105.927S	01 02 41 42
	15x1,5	2700	2940	2520	95	x	10°	275x750	LV105.927SD	01 02 41 42
	15x1,5	2700	2115	2520	95		30°	275x750	LV105.927F	01 02 41 42
	15x1,5	2700	2115	2520	95	x	30°	275x750	LV105.927FD	01 02 41 42
	15x1,5	2700	2325	2520	95		40°	275x750	LV105.927W	01 02 41 42
	15x1,5	2700	2325	2520	95	x	40°	275x750	LV105.927WD	01 02 41 42
	15x1,5	3000	2940	2520	95		10°	275x750	LV105.930S	01 02 41 42
	15x1,5	3000	2940	2520	95	x	10°	275x750	LV105.930SD	01 02 41 42
	15x1,5	3000	2115	2520	95		30°	275x750	LV105.930F	01 02 41 42
	15x1,5	3000	2115	2520	95	x	30°	275x750	LV105.930FD	01 02 41 42
	15x1,5	3000	2325	2520	95		40°	275x750	LV105.930W	01 02 41 42
	15x1,5	3000	2325	2520	95	x	40°	275x750	LV105.930WD	01 02 41 42
	15x1,5	4000	2940	2520	95		10°	275x750	LV105.940S	01 02 41 42
	15x1,5	4000	2940	2520	95	x	10°	275x750	LV105.940SD	01 02 41 42
	15x1,5	4000	2115	2520	95		30°	275x750	LV105.940F	01 02 41 42
	15x1,5	4000	2115	2520	95	x	30°	275x750	LV105.940FD	01 02 41 42
	15x1,5	4000	2325	2520	95		40°	275x750	LV105.940W	01 02 41 42
	15x1,5	4000	2325	2520	95	x	40°	275x750	LV105.940WD	01 02 41 42

3SDCM  
50000h L90  
B10 Ta 25°C

**A+**

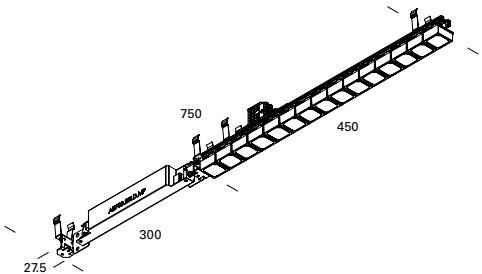



**MODULO 5+5 PER/FOR/POR FILE2 SYSTEM**

5+5 LAMPS TRIMLESS MODULE - MODULO TOTAL EMPOTRABLE 5+5 LAMPARAS

UGR &lt; 19

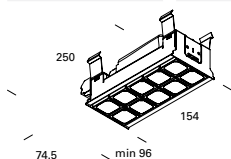
LED	W	K	lm product	lm/Led	CRI	Dali	∠	Dim.	CODE	Col.
3SDCM 50000h L90 B10 Ta 25°C	10x1,5	2700	1960	1680	95		19°	74,5x300	LV121.927S	01 02 41 42
	10x1,5	2700	1960	1680	95	x	19°	74,5x300	LV121.927SD	01 02 41 42
	10x1,5	2700	1410	1680	95		33°	74,5x300	LV121.927F	01 02 41 42
	10x1,5	2700	1410	1680	95	x	33°	74,5x300	LV121.927FD	01 02 41 42
	10x1,5	2700	1550	1680	95		56°	74,5x300	LV121.927W	01 02 41 42
	10x1,5	2700	1550	1680	95	x	56°	74,5x300	LV121.927WD	01 02 41 42
	10x1,5	3000	1960	1680	95		19°	74,5x300	LV121.930S	01 02 41 42
	10x1,5	3000	1960	1680	95	x	19°	74,5x300	LV121.930SD	01 02 41 42
	10x1,5	3000	1410	1680	95		33°	74,5x300	LV121.930F	01 02 41 42
	10x1,5	3000	1410	1680	95	x	33°	74,5x300	LV121.930FD	01 02 41 42
	10x1,5	3000	1550	1680	95		56°	74,5x300	LV121.930W	01 02 41 42
	10x1,5	3000	1550	1680	95	x	56°	74,5x300	LV121.930WD	01 02 41 42
	10x1,5	4000	1960	1680	95		19°	74,5x300	LV121.940S	01 02 41 42
	10x1,5	4000	1960	1680	95	x	19°	74,5x300	LV121.940SD	01 02 41 42
	10x1,5	4000	1410	1680	95		33°	74,5x300	LV121.940F	01 02 41 42
	10x1,5	4000	1410	1680	95	x	33°	74,5x300	LV121.940FD	01 02 41 42
	10x1,5	4000	1550	1680	95		56°	74,5x300	LV121.940W	01 02 41 42
	10x1,5	4000	1550	1680	95	x	56°	74,5x300	LV121.940WD	01 02 41 42

**MODULO 10+10 PER/FOR/POR FILE2 SYSTEM**

10+10 LAMPS TRIMLESS MODULE - MODULO TOTAL EMPOTRABLE 10+10 LAMPARAS

UGR &lt; 19

LED	W	K	lm product	lm/Led	CRI	Dali	∠	Dim.	CODE	Col.
3SDCM 50000h L90 B10 Ta 25°C	20x1,5	2700	3920	3360	95		19°	74,5x300	LV122.927S	01 02 41 42
	20x1,5	2700	3920	3360	95	x	19°	74,5x300	LV122.927SD	01 02 41 42
	20x1,5	2700	2820	3360	95		33°	74,5x300	LV122.927F	01 02 41 42
	20x1,5	2700	2820	3360	95	x	33°	74,5x300	LV122.927FD	01 02 41 42
	20x1,5	2700	3100	3360	95		56°	74,5x300	LV122.927W	01 02 41 42
	20x1,5	2700	3100	3360	95	x	56°	74,5x300	LV122.927WD	01 02 41 42
	20x1,5	3000	3920	3360	95		19°	74,5x300	LV122.930S	01 02 41 42
	20x1,5	3000	3920	3360	95	x	19°	74,5x300	LV122.930SD	01 02 41 42
	20x1,5	3000	2820	3360	95		33°	74,5x300	LV122.930F	01 02 41 42
	20x1,5	3000	2820	3360	95	x	33°	74,5x300	LV122.930FD	01 02 41 42
	20x1,5	3000	3100	3360	95		56°	74,5x300	LV122.930W	01 02 41 42
	20x1,5	3000	3100	3360	95	x	56°	74,5x300	LV122.930WD	01 02 41 42
	20x1,5	4000	3920	3360	95		19°	74,5x300	LV122.940S	01 02 41 42
	20x1,5	4000	3920	3360	95	x	19°	74,5x300	LV122.940SD	01 02 41 42
	20x1,5	4000	2820	3360	95		33°	74,5x300	LV122.940F	01 02 41 42
	20x1,5	4000	2820	3360	95	x	33°	74,5x300	LV122.940FD	01 02 41 42
	20x1,5	4000	3100	3360	95		56°	74,5x300	LV122.940W	01 02 41 42
	20x1,5	4000	3100	3360	95	x	56°	74,5x300	LV122.940WD	01 02 41 42

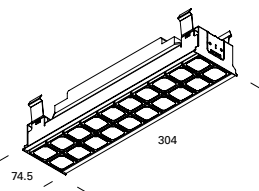

- 01 - telaio bianco - ottica nera - white box - black optic - marco blanco optica negra  
02 - telaio nero - ottica nera - black box - black optic - marco negro - optica negra  
41 - telaio bianco - ottica bianca - white box - white optic - marco blanco - optica blanca  
42 - telaio nero - ottica dorata - black box - golden optic - marco negro - optica dorada



**BASCULANTE 10 PER/FOR/POR CONTAINER FILE2**

10 LAMPS TILT VERSION MODULE - MODULO VERSION BASCULANTE 10 LAMPARAS

UGR &lt; 19

	W	K	lm product	lm/Led	CRI	Dali	∠	Dim.	CODE	Col.
	10x1,5	2700	1960	1680	95		19°	79x315	LV113.927S	01 02 41 42
	10x1,5	2700	1960	1680	95	x	19°	79x315	LV113.927SD	01 02 41 42
	10x1,5	2700	1410	1680	95		33°	79x315	LV113.927F	01 02 41 42
	10x1,5	2700	1410	1680	95	x	33°	79x315	LV113.927FD	01 02 41 42
	10x1,5	2700	1550	1680	95		56°	79x315	LV113.927W	01 02 41 42
	10x1,5	2700	1550	1680	95	x	56°	79x315	LV113.927WD	01 02 41 42
	10x1,5	3000	1960	1680	95		19°	79x315	LV113.930S	01 02 41 42
	10x1,5	3000	1960	1680	95	x	19°	79x315	LV113.930SD	01 02 41 42
	10x1,5	3000	1410	1680	95		33°	79x315	LV113.930F	01 02 41 42
	10x1,5	3000	1410	1680	95	x	33°	79x315	LV113.930FD	01 02 41 42
	10x1,5	3000	1550	1680	95		56°	79x315	LV113.930W	01 02 41 42
	10x1,5	3000	1550	1680	95	x	56°	79x315	LV113.930WD	01 02 41 42
	10x1,5	4000	1960	1680	95		19°	79x315	LV113.940S	01 02 41 42
	10x1,5	4000	1960	1680	95	x	19°	79x315	LV113.940SD	01 02 41 42
	10x1,5	4000	1410	1680	95		33°	79x315	LV113.940F	01 02 41 42
	10x1,5	4000	1410	1680	95	x	33°	79x315	LV113.940FD	01 02 41 42
	10x1,5	4000	1550	1680	95		56°	79x315	LV113.940W	01 02 41 42
	10x1,5	4000	1550	1680	95	x	56°	79x315	LV113.940WD	01 02 41 42

LED  
3SDCM  
50000h L90  
B10 Ta 25°C

A+

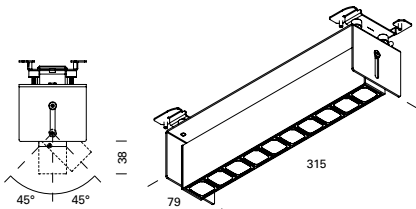
**BASCULANTE 15 PER/FOR/POR CONTAINER FILE2**

15 LAMPS TILT VERSION MODULE - MODULO VERSION BASCULANTE 15 LAMPARA

UGR &lt; 19

	W	K	lm product	lm/Led	CRI	Dali	∠	Dim.	CODE	Col.
	15x1,5	2700	2940	2520	95		19°	79x465	LV114.927S	01 02 41 42
	15x1,5	2700	2940	2520	95	x	19°	79x465	LV114.927SD	01 02 41 42
	15x1,5	2700	2115	2520	95		33°	79x465	LV114.927F	01 02 41 42
	15x1,5	2700	2115	2520	95	x	33°	79x465	LV114.927FD	01 02 41 42
	15x1,5	2700	2325	2520	95		56°	79x465	LV114.927W	01 02 41 42
	15x1,5	2700	2325	2520	95	x	56°	79x465	LV114.927WD	01 02 41 42
	15x1,5	3000	2940	2520	95		19°	79x465	LV114.930S	01 02 41 42
	15x1,5	3000	2940	2520	95	x	19°	79x465	LV114.930SD	01 02 41 42
	15x1,5	3000	2115	2520	95		33°	79x465	LV114.930F	01 02 41 42
	15x1,5	3000	2115	2520	95	x	33°	79x465	LV114.930FD	01 02 41 42
	15x1,5	3000	2325	2520	95		56°	79x465	LV114.930W	01 02 41 42
	15x1,5	3000	2325	2520	95	x	56°	79x465	LV114.930WD	01 02 41 42
	15x1,5	4000	2940	2520	95		19°	79x465	LV114.940S	01 02 41 42
	15x1,5	4000	2940	2520	95	x	19°	79x465	LV114.940SD	01 02 41 42
	15x1,5	4000	2115	2520	95		33°	79x465	LV114.940F	01 02 41 42
	15x1,5	4000	2115	2520	95	x	33°	79x465	LV114.940FD	01 02 41 42
	15x1,5	4000	2325	2520	95		56°	79x465	LV114.940W	01 02 41 42
	15x1,5	4000	2325	2520	95	x	56°	79x465	LV114.940WD	01 02 41 42

LED  
3SDCM  
50000h L90  
B10 Ta 25°C

A+

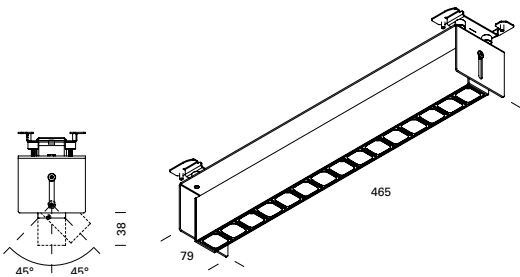



- 01 - telaio bianco - ottica nera - white box - black optic - marco blanco optica negra  
02 - telaio nero - ottica nera - black box - black optic - marco negro - optica negra  
41 - telaio bianco - ottica bianca - white box - white optic - marco blanco - optica blanca  
42 - telaio nero - ottica dorata - black box - golden optic - marco negro - optica dorada



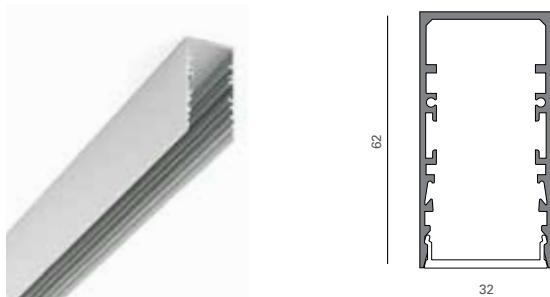

## MINIFILE SISTEMA



PER DETTAGLI, CODICI E ACCESSORI VEDI pag.144  
 FOR DETAILS, CODES AND ACCESSORIES SEE page 144  
 PARA DETALLES, LOS CÓDIGOS Y ACCESORIOS VER pag.144

## FILE2 SISTEMA

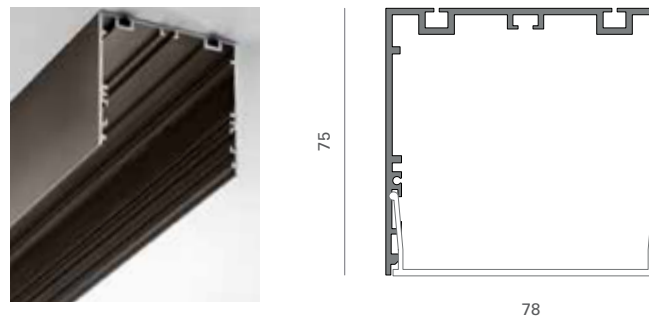

PER DETTAGLI, CODICI E ACCESSORI VEDI pag.282  
 FOR DETAILS, CODES AND ACCESSORIES SEE page 282  
 PARA DETALLES, LOS CÓDIGOS Y ACCESORIOS VER pag.282

## CONTAINER MINIFILE

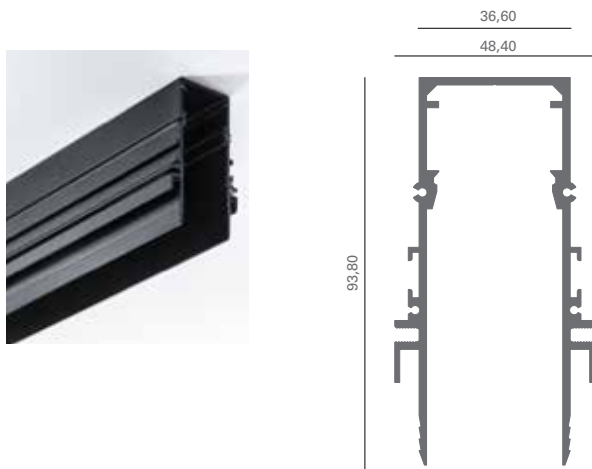

PER DETTAGLI, CODICI E ACCESSORI VEDI pag.348  
 FOR DETAILS, CODES AND ACCESSORIES SEE page 348  
 PARA DETALLES, LOS CÓDIGOS Y ACCESORIOS VER pag.348

## CONTAINER FILE2

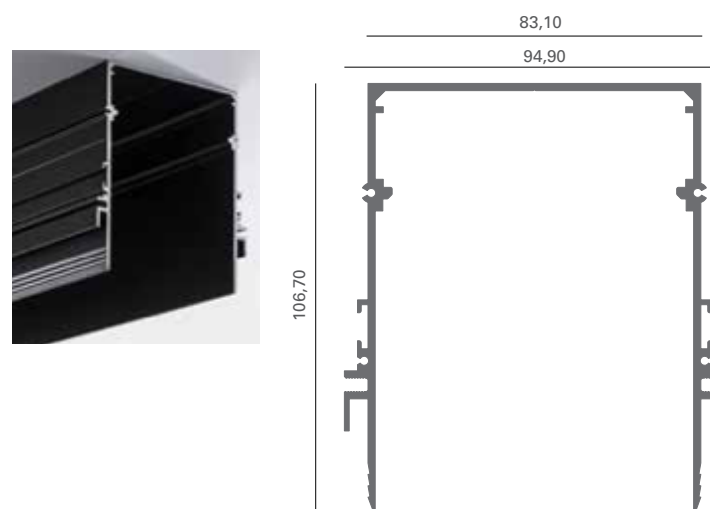

PER DETTAGLI, CODICI E ACCESSORI VEDI pag.356  
 FOR DETAILS, CODES AND ACCESSORIES SEE page 356  
 PARA DETALLES, LOS CÓDIGOS Y ACCESORIOS VER pag.356

## STAFFA SINGOLA PER CASSAFORMA

SINGLE BRACKET - SOPORTE INDIVIDUAL



per/for/por Container Minifile  
 per/for/por Container File2

CODE  
**LTM210**  
**LT2891**

Staffa per fissaggio modulo luminoso all'interno della cassaforma.  
 ordinare 1 al mt. (minimo 2 pezzi) | Single bracket to Fix the lighting  
 module within the wallbox, order 1 per mt. (min. 2 pcs) | soporte indi-  
 vidual por fijar el encofrado, solicite 1 por mt. (2pcs mínimo)

## REGLETTE LED



PER DETTAGLI, CODICI E ACCESSORI VEDI pag.144, 282  
 FOR DETAILS, CODES AND ACCESSORIES SEE page 144, 282  
 PARA DETALLES, LOS CÓDIGOS Y ACCESORIOS VER pag.144, 282

---

Programma di proiettori di dimensioni estremamente contenute completi di sorgente LED chip on board e driver integrato. La gamma si articola in due tipi di apparecchi: spot LED, di forma sferica, orientabili sull'asse verticale e orizzontale, alloggiati in moduli da cinque unità e proiettori di forma cilindrica di diametro 40 e 55mm., orientabili sull'asse verticale e orizzontale, alloggiati in moduli da uno e due unità. Disponibili inseriti all'interno di un modulo finito in estruso di alluminio, installabile a soffitto/parete, incasso e nei Container, o come componenti da inserire all'interno dei profili vuoti FILE o FILE2 a seconda dei modelli. Grado di protezione IP20.

Projectors programme featured by very contained dimensions, complete with chip on board LED and driver. The range articulates in two fixture types: spherical LED spot, adjustable on both vertical and horizontal axis, housed inside a five-units module and cylindrical LED projector, of 40 and 50mm. diameter, adjustable on both vertical and horizontal axis, housed inside a one-or two-units module. Available housed within an extruded aluminum default modules (that can be ceiling-mounted, recessed or inserted within the Container) or as system component to be inserted within the FILE or FILE2 empty profiles, according to the model. Degree of protection IP20.

Programa de proyectores de dimensiones extremadamente reducidas con LED chip on board y driver integrado. La gama se articula en dos clases de aparatos: spot LED, de forma esférica, orientable sobre el eje vertical y horizontal, colocados en módulos de cinco unidades y proyectores de forma cilíndrica de diámetro 40 y 55 mm., orientables sobre el eje vertical y horizontal, colocados en módulos de una y dos unidades. Disponibles colocados en el interior de un módulo acabado en estruso de aluminio, instalable a techo/pared, empotrado en los perfiles Container. o como elementos para insertar en perfiles vacíos FILE o FILE2 en función de los modelos. Grado de protección IP20.

---

**FARETÈN**







## FARETÈN RANGE

Luce d'accento in dimensioni super compatte.

Programma di proiettori di dimensioni estremamente contenute, da impiegare sia all'interno dei profili, per miscelare luce d'accento con luce diffusa, che a parete o soffitto. La gamma si articola in due tipi di apparecchi: spot LED, di forma sferica, orientabile sull'asse verticale e orizzontale, alloggiati in moduli da cinque unità, completi di driver e proiettore LED, di forma cilindrica, di diametro 40 e 55mm., orientabili sull'asse verticale e orizzontale, alloggiati in moduli da uno e due unità.

Super compact accent lighting.

Projectors programme featured by very contained dimensions, for use both in aluminum profiles, to mix accent with diffused lighting, and surface-mounted. The range articulates in two fixture types: spherical LED spot, adjustable on both vertical and horizontal axis, housed inside a five-units module, complete with driver and cylindrical LED projector, of 40 and 50 mm. diameter, adjustable on both vertical and horizontal axis, housed inside a one-or two-units module.

Luz de realce de tamaño muy compacto.

Programa de proyectores de dimensiones muy pequeñas, para usarse tanto al interno de los perfiles Lucifero's, para mezclar la luz de realce con luz difusa, como de pared o de techo. La gama se divide en dos tipos de aparatos: spot LED, de forma esférica, orientable en el eje vertical y horizontal, alojados en módulos de cinco unidades, con driver y proyector LED, cilíndrico, de 40 y 55 mm de diámetro, orientables tanto en el eje vertical como horizontal, alojados en módulos de uno a dos unidades.

# MODULI FINITI - DEFAULT MODULES - MODULOS PREDEFINIDOS

PER/FOR/POR FILE PROFILE



PER/FOR/POR FILE2 PROFILE



FOCUS

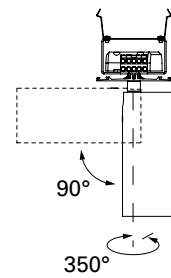

MINISPOT



# SISTEMA - SYSTEM - SISTEMA

**1**

**PROFILE**



FILE CONTAINER



FILE2 CONTAINER

**2**

**LIGHTING MODULE**



**3**

**SYSTEM**







FILE SYSTEM

FILE 2 SYSTEM



## FARETÈN FOCUS 41 PARETE/SOFFITTO

WALL/CEILING - PARED/TECHO



	W	K	Im product	Im/Led	CRI	Dali	∠	Dim.	H	Lmm	CODE	Col.
LED	5	2700	310	395	95		22°	ø40	166	85	FR001.927F	01 02
50000h L90 B10 ta 25°C	5	2700	310	395	95	x	22°	ø40	166	85	FR001.927FD	01 02
<b>A+</b>	5	3000	310	395	95		22°	ø40	166	85	FR001.930F	01 02
	5	3000	310	395	95	x	22°	ø40	166	85	FR001.930FD	01 02



Per installazione in profilo Container File ordinare n.2 LT2481 staffa per fissaggio modulo luminoso all'interno della cassaforma. | To put it in Container File profile order n.2 LT2481 single bracket to fix the lighting module within the wallbox. | Para instalarlo nel perfil Container File ordenar n.2 LT2481 soporte individual por fijar el encofrado.

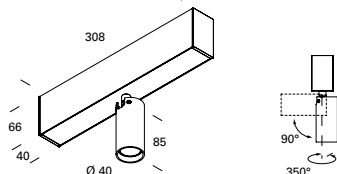

## FARETÈN FOCUS 42 PARETE/SOFFITTO

WALL/CEILING - PARED/TECHO



	W	K	Im product	Im/Led	CRI	Dali	∠	Dim.	H	Lmm	CODE	Col.
LED	2x5	2700	620	790	95		22°	ø40	166	85	FR002.927F	01 02
50000h L90 B10 ta 25°C	2x5	2700	620	790	95	x	22°	ø40	166	85	FR002.927FD	01 02
<b>A+</b>	2x5	3000	620	790	95		22°	ø40	166	85	FR002.930F	01 02
	2x5	3000	620	790	95	x	22°	ø40	166	85	FR002.930FD	01 02



Per installazione in profilo Container File ordinare n.2 LT2481 staffa per fissaggio modulo luminoso all'interno della cassaforma. | To put it in Container File profile order n.2 LT2481 single bracket to fix the lighting module within the wallbox. | Para instalarlo nel perfil Container File ordenar n.2 LT2481 soporte individual por fijar el encofrado.

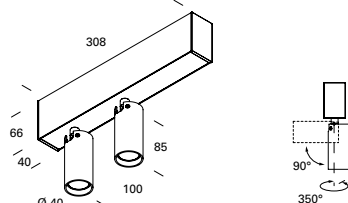

## FARETÈN MINISPOT 5 PARETE/SOFFITTO

WALL/CEILING - PARED/TECHO



	W	K	Im product	Im/Led	CRI	Dali	∠	Dim.	H	CODE	Col.
LED	5x1,5	2700	432	415	95		15°	ø20	66	FR003.927S	01 02
	5x1,5	2700	432	415	95	x	15°	ø20	66	FR003.927SD	01 02
<b>A+</b>	5x1,5	3000	625	600	95		15°	ø20	66	FR003.930S	01 02
	5x1,5	3000	625	600	95	x	15°	ø20	66	FR003.930SD	01 02



Per installazione in Container File ordinare n.2 LT2481 staffa per fissaggio modulo luminoso all'interno della cassaforma. | To put it in Container File profile order n.2 LT2481 single bracket to fix the lighting module within the wallbox. | Para instalarlo nel perfil Container File ordenar n.2 LT2481 soporte individual por fijar el encofrado.

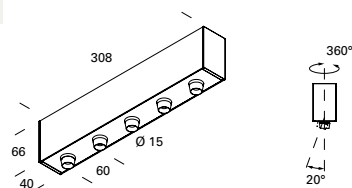

## FARETÈN SPOT 1 PARETE/SOFFITTO

WALL/CEILING - PARED/TECHO



	W	K	Im product	Im/Led	CRI	Dali	△	Dim.	H	CODE	Col.
LED 50000h L90 B10 ta 25°C <b>A+</b>	5	2700	310	395	95		22°	ø40	75	FR005.927F	01 02
	5	2700	310	395	95	x	22°	ø40	75	FR005.927FD	01 02
	5	3000	310	395	95		22°	ø40	75	FR005.930F	01 02
	5	3000	310	395	95	x	22°	ø40	75	FR005.930FD	01 02



Per installazione in profilo Container File2 ordinare n.2 LT2891 staffa per fissaggio modulo luminoso all'interno della cassaforma. | To put it in Container File2 profile order n.2 LT2891 single bracket to fix the lighting module within the wallbox. | Para instalarlo nel perfil Container File2 ordenar n.2 LT2891 soporte individual por fijar el encofrado.

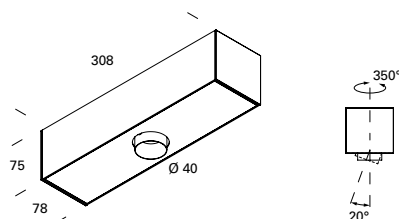

## FARETÈN FOCUS 55 PARETE/SOFFITTO

WALL/CEILING - PARED/TECHO



	W	K	Im product	Im/Led	CRI	Dali	△	Dim.	H	Lmm	CODE	Col.
3SDCM 50000h L90 B10 ta 25°C <b>A+</b>	11	2700	931	1100	>90		29°	ø55	215	125	FR004.927S	01 02
	11	2700	931	1100	>90	x	29°	ø55	215	125	FR004.927SD	01 02
	11	2700	703	1100	>90		42°	ø55	215	125	FR004.927F	01 02
	11	2700	703	1100	>90	x	42°	ø55	215	125	FR004.927FD	01 02
	11	3000	1003	1185	>90		29°	ø55	215	125	FR004.930S	01 02
	11	3000	1003	1185	>90	x	29°	ø55	215	125	FR004.930SD	01 02
	11	3000	757	1185	>90		42°	ø55	215	125	FR004.930F	01 02
	11	3000	757	1185	>90	x	42°	ø55	215	125	FR004.930FD	01 02



Per installazione in profilo Container File2 ordinare n.2 LT2891 staffa per fissaggio modulo luminoso all'interno della cassaforma. | To put it in Container File2 profile order n.2 LT2891 single bracket to fix the lighting module within the wallbox. | Para instalarlo nel perfil Container File2 ordenar n.2 LT2891 soporte individual por fijar el encofrado.

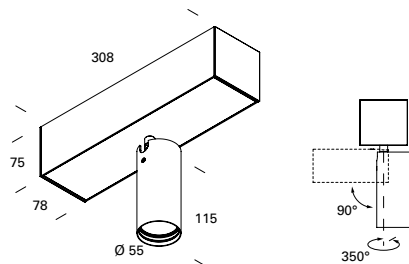

01 - bianco - white - blanco 02 - nero - black - negro

## FARETÈN MINISPOT 5 INCASSO

DOWNLIGHTER - EMPOTRABLE

42x304



LED	W	mA	K	lm product	lm/Led	CRI	∠	A	Dim.	H
A+	5x1,5	500	2700	432	415	95	15°	5.1	ø20	66
	5x1,5	500	3000	625	600	95	15°	5.1	ø20	66

CODE	Col.
FR103.927S	01 02
FR103.930S	01 02



Per cartongesso | For false ceiling | por falso techo

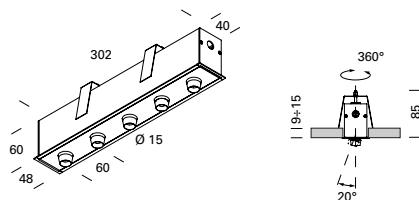

## FARETÈN MINISPOT 5 INCASSO RASATO

TRIMLESS DOWNLIGHTER - TOTAL EMPOTRABLE

42x306



LED	W	mA	K	lm product	lm/Led	CRI	∠	A	Dim.	H
A+	5x1,5	500	2700	432	415	95	15°	5.1	ø20	66
	5x1,5	500	3000	625	600	95	15°	5.1	ø20	66

CODE	Col.
FR203.927S	01 02
FR203.930S	01 02



Per cartongesso | For false ceiling | por falso techo

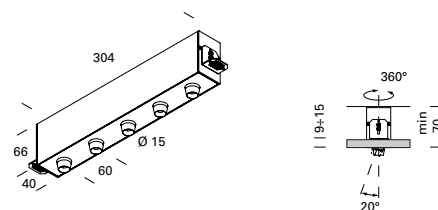





# ZEF, TEF, REFA, RA

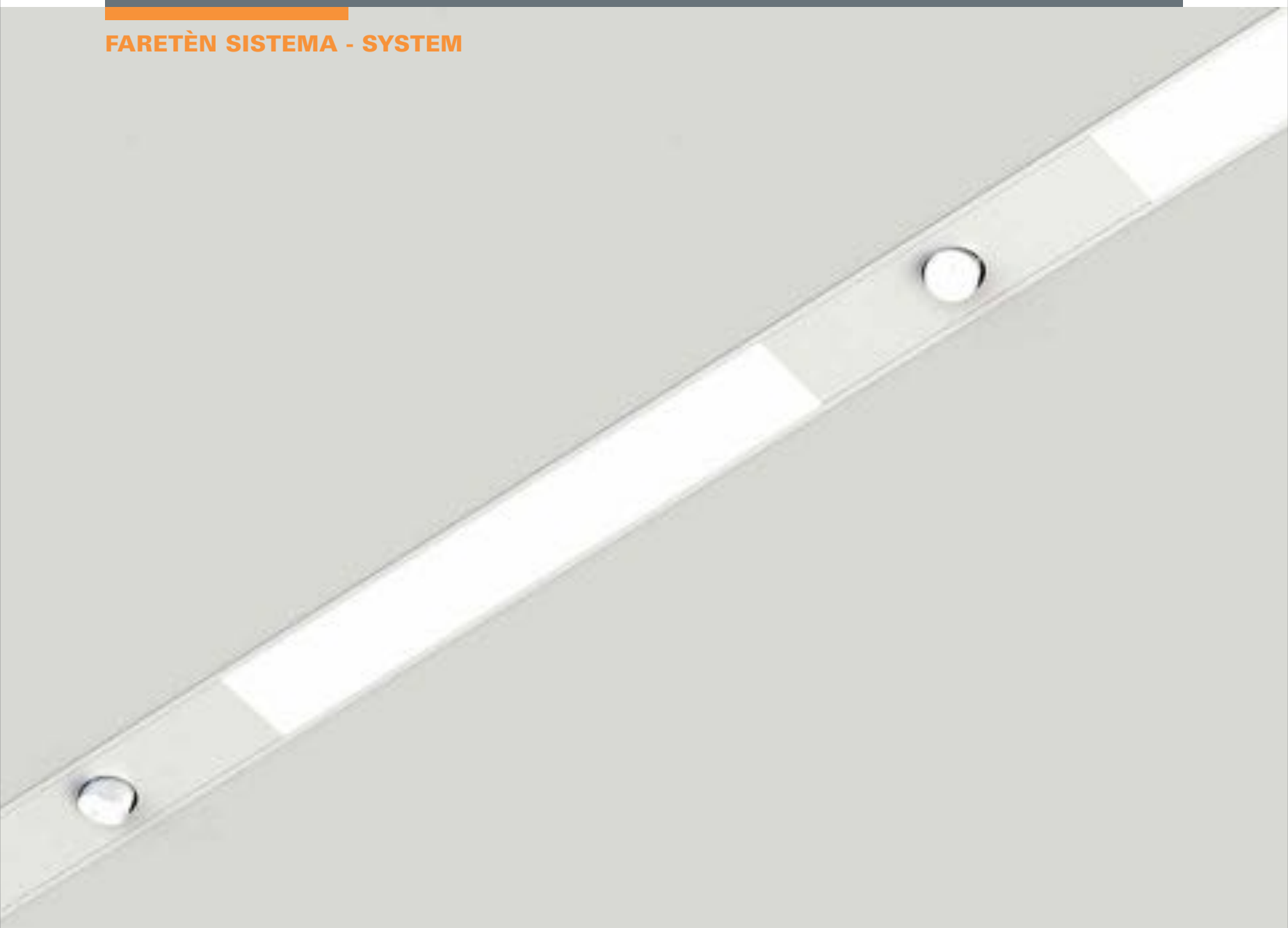





FARETÈN SISTEMA - SYSTEM



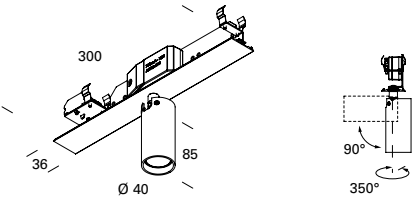



**FARETÈN SISTEMA FOCUS 41S PER/FOR/POR FILE SYSTEM**

	W	K	Im product	Im/Led	CRI	Dali	∠	Dim.	Lmm	H	CODE	Col.	
LED 50000h L90 B10 ta 25°C A+	5	2700	310	395	95		22°	ø40	300x36	85	FR021.927F	01 02	   
	5	2700	310	395	95	x	22°	ø40	300x36	85	FR021.927FD	01 02	
	5	3000	310	395	95		22°	ø40	300x36	85	FR021.930F	01 02	
	5	3000	310	395	95	x	22°	ø40	300x36	85	FR021.930FD	01 02	
	5	3000	310	395	95		22°	ø40	300x36	85			

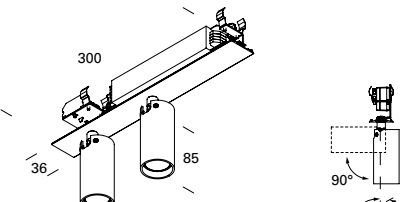

**FARETÈN SISTEMA FOCUS 42S PER/FOR/POR FILE SYSTEM**



	W	K	Im product	Im/Led	CRI	Dali	∠	Dim.	Lmm	H	CODE	Col.	
LED 50000h L90 B10 ta 25°C A+	2x5	2700	620	790	95		22°	ø40	300x36	85	FR022.927F	01 02	   
	2x5	2700	620	790	95	x	22°	ø40	300x36	85	FR022.927FD	01 02	
	2x5	3000	620	790	95		22°	ø40	300x36	85	FR022.930F	01 02	
	2x5	3000	620	790	95	x	22°	ø40	300x36	85	FR022.930FD	01 02	
	2x5	3000	620	790	95		22°	ø40	300x36	85			

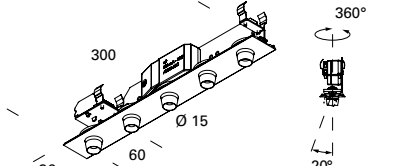

**FARETÈN SISTEMA MINISPOT 5S PER/FOR/POR FILE SYSTEM**

	W	K	Im product	Im/Led	CRI	Dali	∠	Dim.	CODE	Col.	
LED A+	5x1,5	2700	432	415	95		15°	ø20	FR023.927S	01 02	   
	5x1,5	2700	432	415	95	x	15°	ø20	FR023.927SD	01 02	
	5x1,5	3000	625	600	95		15°	ø20	FR023.930S	01 02	
	5x1,5	3000	625	600	95	x	15°	ø20	FR023.930SD	01 02	
	5x1,5	3000	625	600	95		15°	ø20			





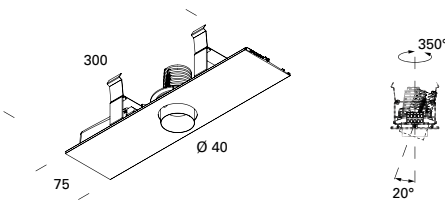





## FARETÈN SISTEMA SPOT 1S PER/FOR/POR FILE2 SYSTEM

	W	mA	K	lm product	lm/Led	CRI	Dali	△	Dim.	Lmm	CODE	Col.	
LED 50000h L90 B10 ta 25°C <b>A+</b>	5		2700	310	395	95		22°	ø40	300x75	FR025.927F	01 02	  
	5		2700	310	395	95	x	22°	ø40	300x75	FR025.927FD	01 02	
	5		3000	310	395	95		22°	ø40	300x75	FR025.930F	01 02	
	5		3000	310	395	95	x	22°	ø40	300x75	FR025.930FD	01 02	

## FARETÈN SISTEMA FOCUS 55S PER/FOR/POR FILE2 SYSTEM

	W	K	lm product	lm/Led	CRI	Dali	△	Dim.	H	Lmm	CODE	Col.	
LED 3SDCM 50000h L90 B10 ta 25°C <b>A+</b>	11	2700	931	1100	>90		29°	ø55	115	300x75	FR024.927S	01 02	   
	11	2700	931	1100	>90	x	29°	ø55	115	300x75	FR024.927SD	01 02	
	11	2700	703	1100	>90		42°	ø55	115	300x75	FR024.927F	01 02	
	11	2700	703	1100	>90	x	42°	ø55	115	300x75	FR024.927FD	01 02	
	11	3000	1003	1185	>90		29°	ø55	115	300x75	FR024.930S	01 02	
	11	3000	1003	1185	>90	x	29°	ø55	115	300x75	FR024.930SD	01 02	
	11	3000	757	1185	>90		42°	ø55	115	300x75	FR024.930F	01 02	
	11	3000	757	1185	>90	x	42°	ø55	115	300x75	FR024.930FD	01 02	

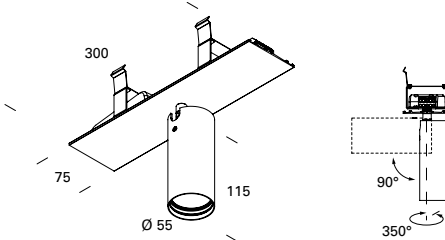

## FILE SISTEMA

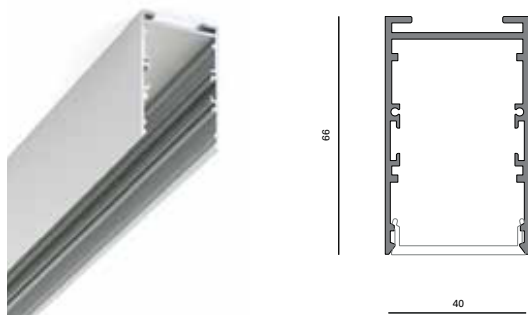

PER DETTAGLI, CODICI E ACCESSORI VEDI PAG.196  
 FOR DETAILS, CODES AND ACCESSORIES SEE PAGE 196  
 PARA DETALLES, LOS CÓDIGOS Y ACCESORIOS VER PAG.196

## FILE2 SISTEMA

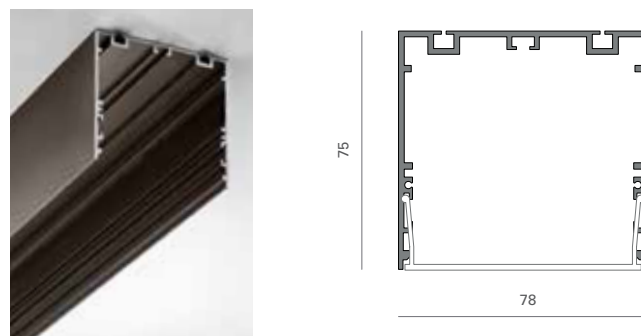

PER DETTAGLI, CODICI E ACCESSORI VEDI PAG.282  
 FOR DETAILS, CODES AND ACCESSORIES SEE PAGE 282  
 PARA DETALLES, LOS CÓDIGOS Y ACCESORIOS VER PAG.282

## CONTAINER FILE

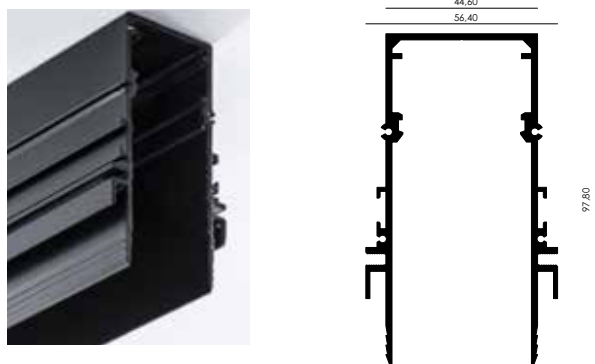

PER DETTAGLI, CODICI E ACCESSORI VEDI PAG.352  
 FOR DETAILS, CODES AND ACCESSORIES SEE PAGE 352  
 PARA DETALLES, LOS CÓDIGOS Y ACCESORIOS VER PAG.352

## CONTAINER FILE2

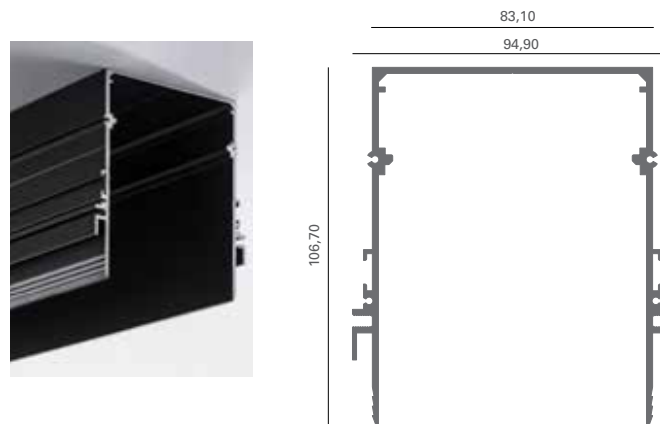

PER DETTAGLI, CODICI E ACCESSORI VEDI PAG.356  
 FOR DETAILS, CODES AND ACCESSORIES SEE PAGE 356  
 PARA DETALLES, LOS CÓDIGOS Y ACCESORIOS VER PAG.356

## STAFFA SINGOLA PER CASSAFORMA

SINGLE BRACKET- SOPORTE INDIVIDUAL



Container File  
 Container File2

CODE  
 LT2481  
 LT2891

staffa per fissaggio modulo luminoso all'interno della cassaforma. ordinare 1 al mt. (minimo 2 pezzi) | Single bracket to Fix the lighting module within the wallbox, order 1 per mt. (min. 2 pcs) | soporte individual por fijar el encofrado, solicite 1 por mt. (2pcs mínimo)

PER DETTAGLI, CODICI E ACCESSORI VEDI PAG.196, 282  
 FOR DETAILS, CODES AND ACCESSORIES SEE PAGE 196, 282  
 PARA DETALLES, LOS CÓDIGOS Y ACCESORIOS VER PAG.196, 282

Serie di apparecchi da incasso con cornice di battuta, da incasso a scomparsa totale trimless, a plafone, per illuminazione diretta diffusa. Sorgenti lineari LED da completare con alimentatore remoto 24Vdc. Corpo in estruso di alluminio, finitura verniciata, completo di schermo diffondente in policarbonato opalino bianco. Testate di chiusura laterali con sistema Light Proof. Grado di protezione IP40 o IP65

Series of fixtures to be ceiling-mounted, recessed or trimless-recessed within flat surfaces or to be trimless-recessed in external and internal angles. Direct diffused lighting emission. Linear LED sources, to be completed with remote 24Vdc driver. Body in extruded aluminium, painted finish, complete with opal white polycarbonate diffuser. Light Proof system side-end caps. Degree of protection IP40 or IP65.

Serie de aparatos a empotrar con marco, sin marco (totalmente empotrado "trimless", a plafón y a empotrar en ángulos de pared, internos o externos, para iluminación difuminada. Fuente de luz lineal LED a completar con alimentador remoto 24Vdc. Cuerpo en estruso de aluminio, acabado barnizado, con difusor en policarbonato opal blanco. Tapas de cierre laterales con sistema "Light Proof" Grado de protección IP40 o IP65.

---

**MICROFILE**





INTERIOR DESIGN NEW TREND BOUTIQUE  
PROJECT ARCH.RAFFAELE DE FILIPPIS  
DESIGNER GIUSEPPE SCHIAVONE

*Just 19,8 mm !*

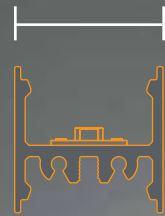

1:1

## SEZIONI PROFILO MICROFILE

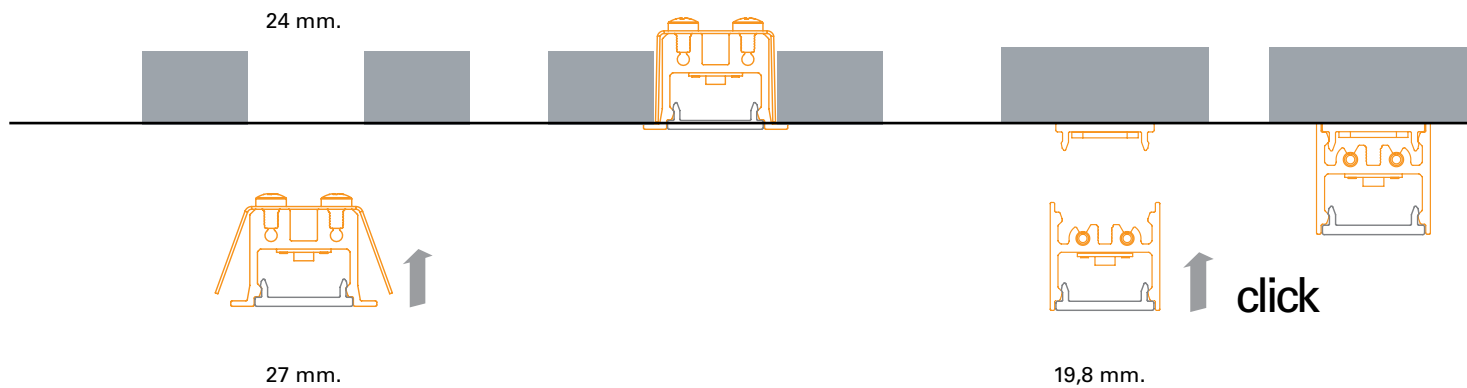

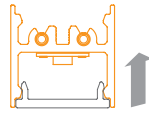
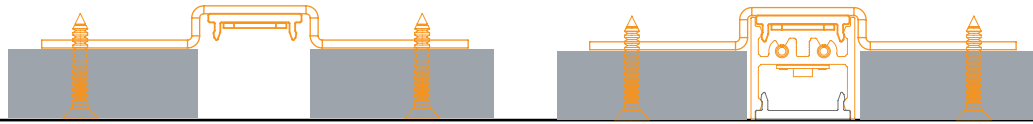

19,8 mm.



INCASSO RASATO- TRIMLESS RECESSED - TOTAL EMPOTRADO

## SEZIONI PROFILO MICROFILE

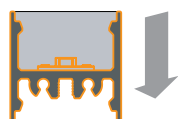

19,8 mm.

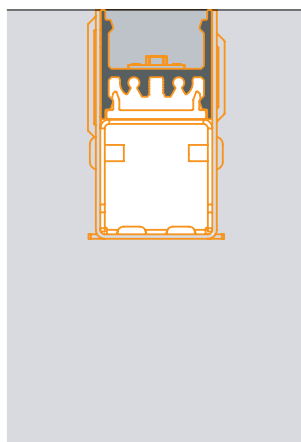
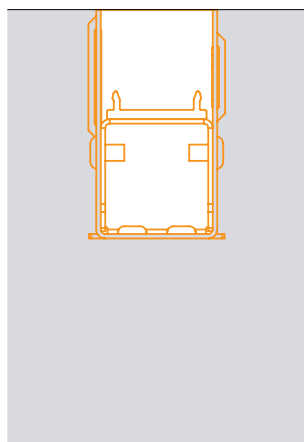

INCASSO RASATO CALPESATABILE IP65 -  
IP65 WALKABLE TRIMLESS RECESSED

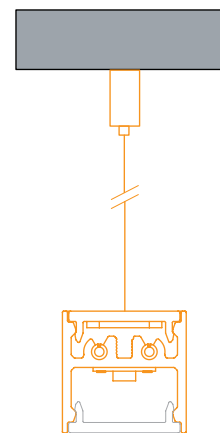

19,8 mm.

SOSPENSIONE - SUSPENSION



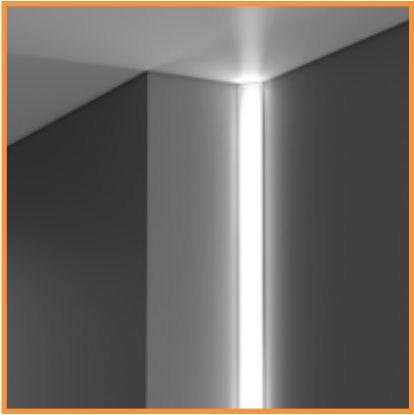

Un solo profilo due possibilità di installazione  
 One profile two installation possibilities

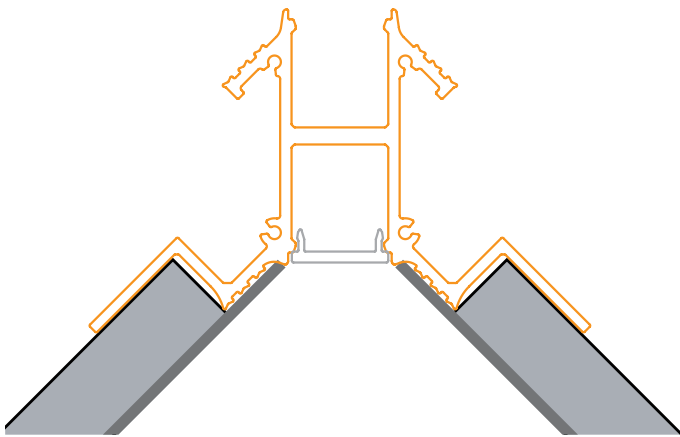

19,8 mm.

INSTALLAZIONE IN ANGOLO INTERNO  
 RECESSED WITHIN AN INSIDE CORNER

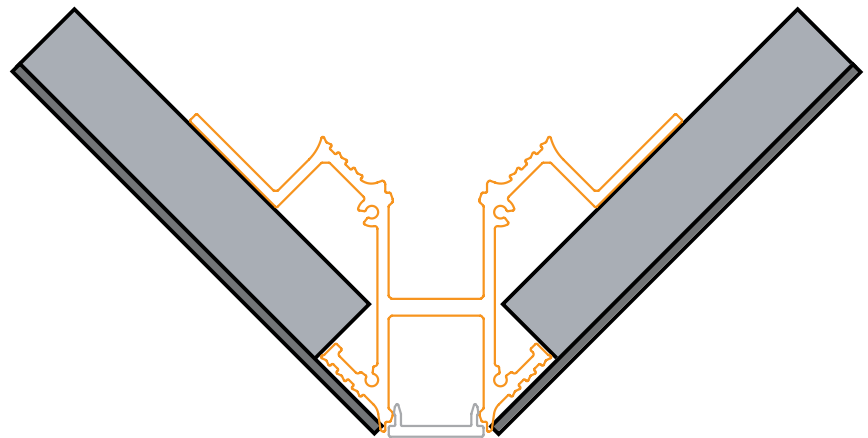

19,8 mm.

INSTALLAZIONE IN ANGOLO ESTERNO  
 RECESSED WITHIN AN OUTSIDE CORNER

## MICROFILE INCASSO

RECESSED- EMPOTRABLE

24xL+2



	W	K	lm product	lm/Led	CRI	A	Lmm	Kg	CODE	Col.
linear LED	16,2	3000	1143	1980	>80	V.1	920	0,58	MF02.1	01
	21,6	3000	1524	2640	>80	V.1	1215	0,61	MF02.2	01
	27	3000	1905	3300	>80	V.1	1515	0,80	MF02.3	01

18W/mt 168 LED/mt 2200 lm/mt 24V

A+

Da completare con alimentatore remoto | To be completed with remote power supply

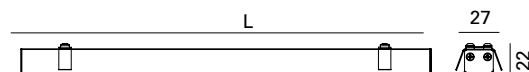

## MICROFILE INCASSO RASATO

TRIMLESS RECESSED - TOTAL EMPOTRADO

25xL+2



	W	K	lm product	lm/Led	CRI	A	Lmm	Kg	CODE	Col.
linear LED	16,2	3000	1143	1980	>80	V.1	920	0,35	MF05.1	01
	21,6	3000	1524	2640	>80	V.1	1215	0,42	MF05.2	01
	27	3000	1905	3300	>80	V.1	1515	0,52	MF05.3	01

18W/mt 168 LED/mt 2200 lm/mt 24V

A+

Da completare con alimentatore remoto | To be completed with remote power supply

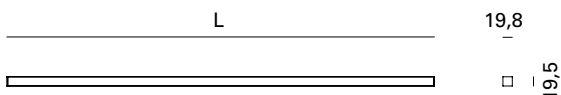

## MICROFILE INCASSO RASATO CALPESTABILE IP65 19W/MT

IP65 WALKABLE TRIMLESS RECESSED - IP65 TOTAL EMPOTRADO TRANSITABLE



	W	K	lm product	lm/Led	CRI	A	Lmm	Kg	CODE	Col.
linear LED	9,5	3000	485	840	>80	V.1	510	0,40	MF06.1	27
	19	3000	970	1680	>80	V.1	1010	0,56	MF06.2	27

19W/mt IP65 240LED/mt 1680lm/mt 24V

A+

Da completare con alimentatore remoto | To be completed with remote power supply

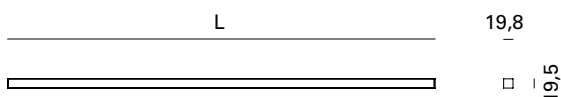

da completare con cassaforma - to complete with wallbox- a ser completado con un caja pag.115



01 - bianco - white - blanco

27 - ossidato alluminio - oxidised aluminium - oxidado aluminio

## MICROFILE SOFFITTO

WALL/CEILING- TECHO/PARED



	W	K	lm product	lm/Led	CRI	A	Lmm	Kg	CODE	Col.	
linear LED	16,2	3000	1143	1980	>80	V.1	925	0,48	MF01.1	01	
18W/mt 168 LED/mt 2200lm/mt 24V	21,6	3000	1524	2640	>80	V.1	1220	0,51	MF01.2	01	
<b>A+</b>	27	3000	1905	3300	>80	V.1	1515	0,90	MF01.3	01	

Da completare con alimentatore remoto | To be completed with remote power supply

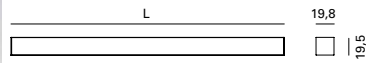

## MICROFILE SOSPENSIONE

SUSPENSION- SUSPENSION



	W	K	lm product	lm/Led	CRI		Lmm	Kg	CODE	Col.	
linear LED	16,2	3000	1143	1980	>80		925	1,10	MF03.1	01	
18W/mt 168 LED/mt 2200lm/mt 24V	21,6	3000	1524	2640	>80		1220	1,20	MF03.2	01	
<b>A+</b>	27	3000	1905	3300	>80		1515	2,20	MF03.3	01	

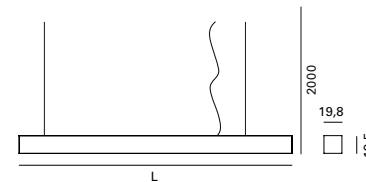

Accessori - Accessories - Accesorios

## CASSAFORMA IN ACCIAIO AISI304

STAINLESS STEEL AISI304 WALLBOX - CAJA DE ACERO AISI304



	Dim. Lmm	Kg	CODE	
	22x 510	0,28	MF06.C1	
	22x 1010	0,60	MF06.C2	

01 - bianco - white - blanco

pag.824

**A** pag.820

## MICROFILE SISTEMA

Sistema modulare per illuminazione diretta, diffusa, composto da profili vuoti in estruso di alluminio verniciato o anodizzato disponibili in lunghezze predefinite o ordinabili a misura disponibili nelle versioni a parete, plafone, sospensione, incasso rasato a scomparsa totale e da incasso in angoli parete interni o esterni. Testate di chiusura laterali con sistema Light Proof e di schermo diffondente in PC opalino bianco. Da integrare con sorgenti lineari LED. Da completare con staffe di fissaggio o cavi di sospensione. Grado di protezione IP40 o IP43 a seconda della zona d'installazione.

Modular system for direct, diffused and/or accent lighting, made of painted or anodised extruded aluminium empty profiles, available in predefined lengths or cut to measure. Available in wall-mounted, ceiling-mounted, suspended, trimless recessed or to be trimless-recessed in external and internal angles. For direct diffused lighting. Body in extruded aluminium. Painted or anodized finish. Complete with Light Proof system side end caps, opal white polycarbonate diffusing screen. and mounting brackets or suspension cables. Available in predefined lengths or cut to measure. To be integrated with linear LED sources . IP40 or 43 degree of protection according to the area where it is installed.

Sistema modular para la iluminación directa, difusa y/o concentrada. Compuesto de perfil vacío en estruso de aluminio barnizado o anodizado de largo predefinida o cortable a medida. Disponible en la versiones de pared, plafón, suspensión, totalmente empotrado "trimless" o empotrado y a empotrar en ángulos de pared, internos o externos. Tapas de cierre laterales con sistema "Light Proof". Grado de protección IP40, IP43 según la zona de instalación. Se complementan con soporte de fijación o cables de suspensión.



## PROFILO VUOTO INCASSO

EMPTY RECESSED PROFILE - PERFIL VACIO EMPOTRABLE



Lmm	CODE	Col.
1000	MF02.1000	01
2000	MF02.2000	01
3000	MF02.3000	01
.....	MF02.misura* 01	



## PROFILO VUOTO INCASSO X

X-SHAPED EMPTY RECESSED PROFILE- PERFIL VACIO EMPOTRABLE X



Dim.	CODE	Col.
200 x 200	MF02.X	01

molle per fissare il profilo al cartone include |  
spring to fix the perfil to the false ceiling included  
| muelle para la fijación del perfil en el falso  
techo incluido.

## PROFILO VUOTO INCASSO 90°

90°-SHAPED EMPTY RECESSED PROFILE - PERFIL VACIO EMPOTRABLE 90°



Dim.	CODE	Col.
110 x 110	MF02.90	01

molle per fissare il profilo al cartone include |  
spring to fix the perfil to the false ceiling included  
| muelle para la fijación del perfil en el falso  
techo incluido.

## PROFILO VUOTO INCASSO T

T-SHAPED EMPTY RECESSED PROFILE- PERFIL VACIO EMPOTRABLE T



Dim.	CODE	Col.
200 x 110	MF02.T	01

molle per fissare il profilo al cartone include |  
spring to fix the perfil to the false ceiling included  
| muelle para la fijación del perfil en el falso  
techo incluido.

## COPPIA TESTATE INCASSO

COUPLE OF CLOSURE HEADS FOR RECESSED VERSION - PAREJA DE TAPAS FINALES TOTAL EMPOTRABLE



CODE	Col.
MF00TI	01

## PROFILO VUOTO INCASSO PARETE/SOFFITTO

EMPTY RECESSED PROFILE WALL/CEILING - PERFIL VACIO PARED-TECHO



Dim.	CODE	Col.
200+20 x 200+20	MF02.PS	01

molle per fissare il profilo al cartone include |  
spring to fix the perfil to the false ceiling included  
| muelle para la fijación del perfil en el falso  
techo incluido.

## MOLLA DI FISSAGGIO INCASSO

FIXING BRACKET FOR RECESSED VERSION - SOPORTE INDIVIDUAL PARA FIJACIÓN EMPOTRABLE PERFIL



CODE
MF02.SF

molla di fissaggio per profilo lineare incasso una ogni  
metro, minimo 2 - fixing bracket for linear recessed  
version. one every meter, 2 pieces minimum - soporte  
individual para fijación empotrable perfil lineal, uno  
cada metro, mínimo 2.

\*Tramite questo codice è possibile ordinare il profilo in una lunghezza lineare non standard. Sostituire alla parola "misura" la lunghezza desiderata in mm. Per ordinare un profilo con una o entrambe le estremità tagliate ad angolo 45° aggiungere alla misura la lettera "D" (taglio Destro) o "S" (taglio Sinistro). Seguire istruzioni riportate a pag. 834. Per profili oltre i 3 mt e massimo 6 mt le condizioni di trasporto sono da concordare. | | \*Through this code it's possible to order the profile in a not-standard linear length. Replace the word "misura" with the desired length in mm. To order a profile with one or both ends 45° angle-cut add the letter "D" (right cut) or "S" (left cut) to the standard or custom length. follow the instructions on page 834. for lengths over 3 mt. to max. 6 mt. transport conditions to negotiate. | | \*el uso de este código, se puede ordenar el perfil en un lineal longitud no estándar. Sustitúyase la palabra "medida" de la longitud en mm. Para pedir un perfil con uno o ambos extremos cortados en un ángulo de 45 ° a añadir a la medida de la letra "D" (derecha cortada) o "S" (izquierda cortada). Siga las instrucciones de la página. 834. Perfiles para más de 3 my 6 m Condiciones máximas de transporte a convenir.

## PROFILO VUOTO INCASSO RASATO

EMPTY PROFILE TRIMLESS / PERFIL VACIO TOTAL EMPOTRABLE



L.mm	CODE	Col.
1000	MF01.1000	01
2000	MF01.2000	01
3000	MF01.3000	01
.....	MF01.misura* 01	



## COPPIA TESTATA INCASSO RASATO

COUPLE OF CLOSURE HEADS FOR TRIMLESS VERSION - PAREJA DE TAPAS FINALES TOTAL EMPOTRABLE



CODE	Col.
MF00TP	01

## PROFILO VUOTO INCASSO RASATO X

X-SHAPED EMPTY TRIMLESS RECESSED PROFILE- PERFIL VACIO TOTAL EMPOTRABLE X

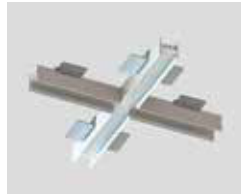

Dim.	CODE	Col.
200 x 200	MF01.X	01

staffe per fissare il profilo al cartonesso include |  
brackets to fix the perfil to the false ceiling included |  
soportes para la fijación del perfil en el falso  
techo incluido.

## PROFILO VUOTO RASATO PARETE/SOFFITTO

EMPTY TRIMLESS RECESSED PROFILE WALL/CEILING - PERFIL VACIO TOTAL EMPOTRABLE PARED-TECHO



Dim.	CODE	Col.
200+20 x 200+20	MF01.PS	01

staffe per fissare il profilo al cartonesso include |  
brackets to fix the perfil to the false ceiling included |  
soportes para la fijación del perfil en el falso  
techo incluido.

## PROFILO VUOTO INCASSO RASATO 90°

90°-SHAPED EMPTY TRIMLESS RECESSED PROFILE- PERFIL VACIO TOTAL EMPOTRABLE 90°



Dim.	CODE	Col.
110 x 110	MF01.90	01

staffe per fissare il profilo al cartonesso include |  
brackets to fix the perfil to the false ceiling included |  
soportes para la fijación del perfil en el falso  
techo incluido.

## STAFFE DI FISSAGGIO INCASSO RASATO

FIXING BRACKET FOR TRIMLESS RECESSED - SOPORTE INDIVIDUAL PARA FIJACIÓN TOTAL EMPOTRABLE



CODE
MF05.SF

staffa di fissaggio per profilo incasso rasato lineare  
una ogni metro, minimo 2 - fixing bracket for trimless  
recessed linear version. one every meter, 2 pieces  
minimum - soporte individual para fijación total empo-  
trable perfil lineal, uno cada metro, mínimo 2.

## PROFILO VUOTO INCASSO RASATO T

T-SHAPED EMPTY TRIMLESS RECESSED PROFILE - PERFIL VACIO TOTAL EMPOTRABLE T



Dim.	CODE	Col.
200 x 110	MF01.T	01

staffe per fissare il profilo al cartonesso include |  
brackets to fix the perfil to the false ceiling included |  
soportes para la fijación del perfil en el falso  
techo incluido.

## PROFILO VUOTO SOFFITTO

EMPTY PROFILE CEILING - PERFIL VACIO TECHO



Lmm	CODE	Col.
1000	<b>MF01.1000</b>	<b>01</b>
2000	<b>MF01.2000</b>	<b>01</b>
3000	<b>MF01.3000</b>	<b>01</b>
.....	<b>MF01.misura* 01</b>	

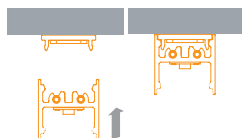

## COPPIA TESTATA SOFFITTO

COUPLE OF CLOSURE HEADS FOR CEILING VERSION - PAREJA DE TAPAS FINALES TECHO



Dim.	CODE	Col.
200 x 110	<b>MF00TP</b>	<b>01</b>

## PROFILO VUOTO SOFFITTO X

X-SHAPED EMPTY TRIMLESS CEILING PROFILE- PERFIL VACIO TECHO X



Dim.	CODE	Col.
200 x 200	<b>MF07.X</b>	<b>01</b>

## PROFILO VUOTO SOFFITTO T

T-SHAPED EMPTY CEILING PROFILE- PERFIL VACIO TECHO T



Dim.	CODE	Col.
200 x 110	<b>MF07.T</b>	<b>01</b>

## PROFILO VUOTO SOFFITTO 90°

90°-SHAPED EMPTY CEILING PROFILE - PERFIL VACIO TECHO 90°



Dim.	CODE	Col.
110 x 110	<b>MF07.90</b>	<b>01</b>

## PROFILO VUOTO PARETE/SOFFITTO

EMPTY ANGLE PROFILE WALL-CEILING - PERFIL VACIO PARED-TECHO



Dim.	CODE	Col.
200+20 x 200+20	<b>MF07.PS</b>	<b>01</b>

## SISTEMA D'AGGANCIO PER SOFFITTO

SURFACE MOUNTING KIT - TECHO SOPORTE



N.	Lmm	CODE
3	1000	<b>MF00DP.1000</b>
5	2000	<b>MF00DP.2000</b>
7	3000	<b>MF00DP.3000</b>

01 - bianco - white - blanco



## PROFILO VUOTO INCASSO ANGOLARE

EMPTY CORNER RECESSED PROFILE - PERFIL VACIO ANGULAR



Lmm	CODE	Col.
1000	MF04.1000	01
2000	MF04.2000	01
3000	MF04.3000	01
	MF04.misura* 01	

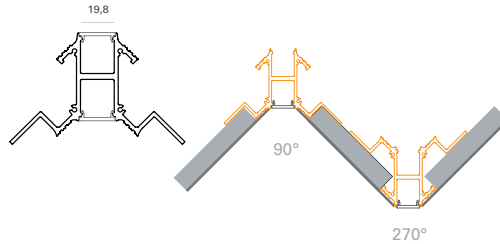

## COPPIA TESTATE ANGOLARE

COUPLE OF CLOSURE HEADS CORNER RECESSEDVERSION - PAREJA DE TAPAS FINALES ANGULAR



CODE	Col.
MF00TA	01

## STRIP BOBINA DA 5 METRI

STRIP LED 5 METERS ROLL - BOBINA STRIP LED 5 METROS



LINEAR LED 24V	W/mt	V	Led/ mt	lm/mt	K	lm product	lm/W	CRI	IP	A	Lmm	Kg	CODE
A+	1x5,5	24	60	270	3000	1350	245	80	20	V.1	5000	0,18	ST05.30.5
	1x9,6	24	120	540	3000	2700	281	80	20	V.1	5000	0,18	ST10.30.5
	1x11	24	180	1200	3000	6000	545	80	20	V.1	5000	0,18	ST11.30.5
	1x18	24	168	2200	3000	11000	611	80	20	V.1	5000	0,18	ST21.30.5
LINEAR LED IP65 24V	W/mt	V	Led/ mt	lm/mt	K	lm product	lm/W	CRI	IP	A	Lmm	Kg	CODE
A+	1x9,6	24	120	540	3000	2700	281	80	65	V.1	5000	0,18	ST10.30.5IP
	1x14,4	24	60	900	3000	4500	313	80	65	V.1	5000	0,18	ST15.30.5IP
	1x19,2	24	240	1080	3000	5400	281	80	65	V.1	5000	0,18	ST20.30.5IP

\*Tramite questo codice è possibile ordinare il profilo in una lunghezza lineare non standard. Sostituire alla parola "misura" la lunghezza desiderata in mm. Per ordinare un profilo con una o entrambe le estremità tagliate ad angolo 45° aggiungere alla misura la lettera "D" (taglio Destro) o "S" (taglio Sinistro). Seguire istruzioni riportate a pag. 834. Per profili oltre i 3 mt e massimo 6 mt le condizioni di trasporto sono da concordare. || \*Through this code it's possible to order the profile in a not-standard linear length. Replace the word "misura" with the desired length in mm. To order a profile with one or both ends 45° angle-cut add the letter "D" (right cut) or "S" (left cut) to the standard or custom length. Follow the instructions on page 834. For lengths over 3 mt. to max. 6 mt. transport conditions to negotiate. || \*el uso de este código, se puede ordenar el perfil en un lineal longitud no estándar. Sustitúyase la palabra "medida" de la longitud en mm. Para pedir un perfil con uno o ambos extremos cortados en un ángulo de 45° a añadir a la medida de la letra "D" (derecha cortada) o "S" (izquierda cortada). Siga las instrucciones de la página. 834. Perfiles para más de 3 my 6 m Condiciones máximas de transporte a convenir.



pag.824



pag.820

Serie di apparecchi da incasso, incasso a scomparsa totale trimless, a soffitto o parete e a sospensione per illuminazione diretta, diffusa e/o d'accento, per sorgenti lineari LED, lampade fluorescenti T16 seamless e spot LED. Alimentazione elettronica integrata 50/60Hz 230/240V. Corpo in estruso di alluminio 62x32mm. Finitura verniciata o anodizzata. Cornice di battuta super-slim larghezza 5 mm. Completi di staffe di fissaggio al controsoffitto con sistema di regolazione a vite e testate di chiusura laterali. Versioni con sorgenti lineari LED e per lampade fluorescenti complete di schermo diffondente in policarbonato opalino bianco, versioni con spot LED complete di coppia di sagomatori in estruso di alluminio ad innesto rapido. Grado di protezione IP20/IP23 o IP40/IP43 a seconda dei modelli. Cassaforma in estruso di alluminio per incasso in laterizio o calcestruzzo disponibile come accessorio.

Series of recessed and trimless recessed, ceiling/wall mounted and hanging fixtures for direct, diffused and/or accent, lighting. For integrated linear LED sources, T16 fluorescent seamless lamps and integrated LED spotlights. 230/240V 50/60Hz integrated electronic supply. Body in 62x32 mm. extruded aluminium. Painted or anodized finish. Super-slim 5 mm. width edge trim. Complete with false-ceiling/wall fixing brackets, provided with micro-regulation screw system and side end caps. Models with integrated linear LED sources and for fluorescent lamps complete with opal white polycarbonate diffuser, versions with integrated LED spotlight complete with couple of quick mounting extruded aluminium shapers. Protection degree IP20/IP23 or IP40/IP43, according to the chosen model. Extruded aluminium wallbox for recessed installation in concrete or brick walls, available as an accessory.

Serie de aparatos empotrados, total empotrado, techo/pared y suspensión para iluminación directa, difuminada y/o concentrada, para LED, fluorescentes T16 seamless y spot LED. Alimentación electrónica integrada 50/60Hz 230V/240V. Cuerpo en estruso de aluminio 62x32mm. Acabado pintado o anodizado. Marco "super-slim" de sólo 5mm. Con soporte de fijación al falso techo con sistema de regulación mediante tornillo y tapas de cierre laterales. Versiones con LED lineales y fluorescentes con difusor en policarbonato opal blanco, versiones con spot LED con moldeadores en estruso de aluminio de fijación rápida. Grado de protección IP20/23 o IP40/43 según modelos. Caja en estruso de aluminio para la instalación en ladrillo u hormigón disponible como accesorio.

**MINIFILE**







## SEZIONI PROFILO MINIFILE

### INCASSO - RECESSED - EMPOTRADO

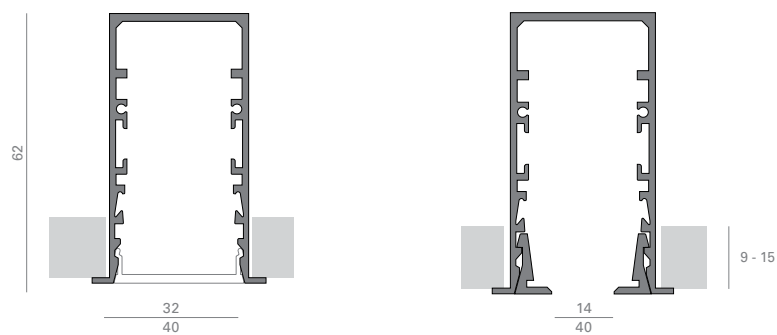

DIFFUSORE IN POLICARBONATO OPALINO  
OPALINE POLYCARBONATE DIFFUSER  
DIFUSOR EN POLICARBONATO OPALINO



SAGOMATORE AD INNESTO RAPIDO  
CLICK-SYSTEM SHAPER  
MOLDEADOR SISTEMA FIJACION RAPIDA

### INCASSO RASATO - TRIMLESS RECESSED

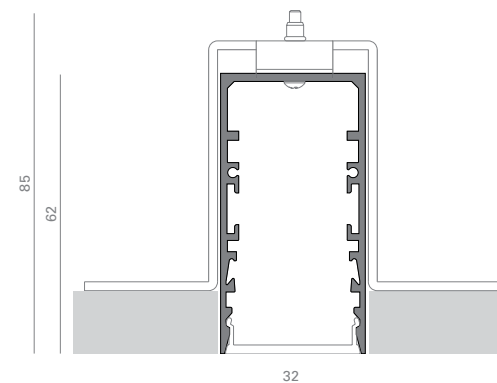

DIFFUSORE IN POLICARBONATO OPALINO  
OPALINE POLYCARBONATE DIFFUSER  
DIFUSOR EN POLICARBONATO OPALINO

**TOTAL EMPOTRADO**

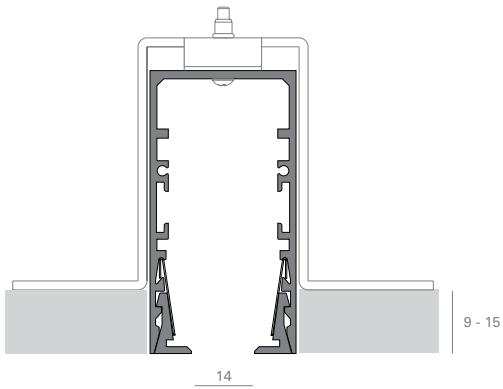

**SOFFITTO  
SOSPENSIONE  
PARETE**

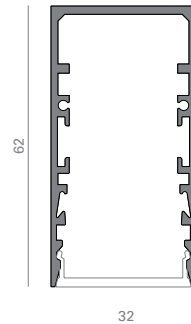

**CEILING  
SUSPENSION  
WALL**

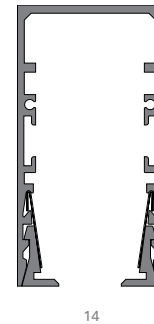

**TECHO  
SUSPENSIÓN  
PARED**



SAGOMATORE AD INNESTO RAPIDO  
CLICK-SYSTEM SHAPER  
MOLDEADOR SISTEMA FIJACIÓN RÁPIDA



DIFFUSORE IN POLICARBONATO OPALINO  
OPALINE POLYCARBONATE DIFFUSER  
DIFFUSOR EN POLICARBONATO OPALINO



SAGOMATORE AD INNESTO RAPIDO  
CLICK-SYSTEM SHAPER  
MOLDEADOR SISTEMA FIJACIÓN RÁPIDA

## MINIFILE INCASSO CON DIFFUSORE



34xL+2



RECESSED WITH DIFFUSER - EMPOTRADO CON DIFUSOR

	W	K	lm product	lm/Led	CRI	DaliT&D	L:mm	CODE	Col.
	12,8	3000	736	1232	>80		580	LTM101	01 02 27
	12,8	3000	736	1232	>80	X	580	LTM101D	01 02 27
	19,2	3000	1104	1848	>80		860	LTM102	01 02 27
	19,2	3000	1104	1848	>80	X	860	LTM102D	01 02 27
	25,6	3000	1472	2464	>80		1140	LTM103	01 02 27
	25,6	3000	1472	2464	>80	X	1140	LTM103D	01 02 27
	32	3000	1840	3080	>80		1420	LTM104	01 02 27
	32	3000	1840	3080	>80	X	1420	LTM104D	01 02 27
	38,4	3000	2208	3696	>80		1700	LTM105	01 02 27
	38,4	3000	2208	3696	>80	X	1700	LTM105D	01 02 27
	44,8	3000	2576	4312	>80		1985	LTM106	01 02 27
	44,8	3000	2576	4312	>80	X	1985	LTM106D	01 02 27
	51,2	3000	2944	4928	>80		2265	LTM107	01 02 27
	51,2	3000	2944	4928	>80	X	2265	LTM107D	01 02 27
	57,6	3000	3313	5544	>80		2545	LTM108	01 02 27
	57,6	3000	3313	5544	>80	X	2545	LTM108D	01 02 27
	64	3000	3681	6160	>80		2825	LTM109	01 02 27
	64	3000	3681	6160	>80	X	2825	LTM109D	01 02 27

LINEAR LED 24W/MT  
2200lm/MT CRI>80

50000h Ta 25°  
L70B10 **A+**

CE  



  

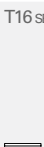

Su richiesta disponibile la versione 4000K. | On request available 4000K version. | Versión con 4000K a demanda.

	W	L:mm	CODE	Col.
	14-24	587	LTM083	01 02 27
	21-39	887	LTM084	01 02 27
	28-54	1187	LTM085	01 02 27
	1+1x21-39	1776	LTM086	01 02 27
	1+1x21-39	1776	LTM086D	01 02 27
	1+1x28-54	2376	LTM087	01 02 27
	1+1x28-54	2376	LTM087D	01 02 27

T16 SEAMLESS

**A++-A**

CE  

Su richiesta versioni Emergenza | Emergency versions on request | Versiones de emergencia a demanda



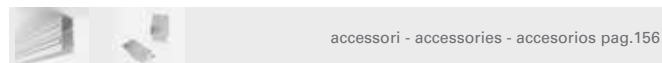
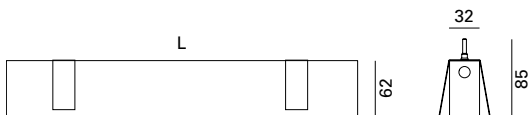

## MINIFILE INCASSO 3 SPOT LED

34xL+2



	W	K	lm product	lm/Led	CRI	△
spot LED 136lm/ MtCRI>80	3x1,5	3000	756	1050	>80	16°
	3x1,5	3000	408	567	>80	30°
50000h L70 B10 ta 25°C	A+					

Lmm	CODE	Col.	CE
302	LTMF172	01 02	
302	LTMF173	01 02	

alimentatore incluso | ballast included | con trasformador

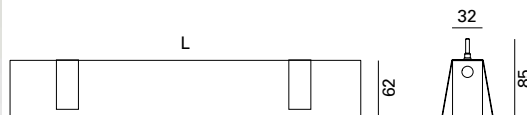

accessori - accessories - accesorios pag.156

## MINIFILE INCASSO 6 SPOT LED

34xL+2



	W	K	lm product	lm/Led	CRI	△
spot LED 136lm/ MtCRI>80	6x1,5	3000	1512	2100	>80	16°
	6x1,5	3000	816	1134	>80	30°
50000h L70 B10 ta 25°C	A+					

Lmm	CODE	Col.	CE
602	LTMF174	01 02	
602	LTMF175	01 02	

alimentatore incluso | ballast included | con trasformador

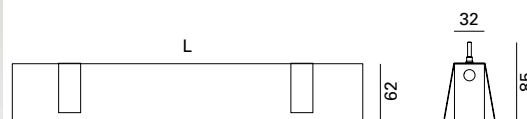

accessori - accessories - accesorios pag.156





## INCASSO RASATO CON DIFFUSORE

TRIMLESS RECESSED WITH DIFFUSER - TOTAL EMPOTRABLE CON DIFUSOR

34xL+2



LINEAR LED 24W/MT  
2200lm/MT CRI>80

50000h Ta  
25° L70B10

A+

W	K	lm product	lm/Led	CRI	DalIT&D	L.mm	CODE	Col.
12,8	3000	736	1232	>80		580	LTML10	01
12,8	3000	736	1232	>80	X	580	LTML10D	01
19,2	3000	1104	1848	>80		860	LTML11	01
19,2	3000	1104	1848	>80	X	860	LTML11D	01
25,6	3000	1472	2464	>80		1140	LTML12	01
25,6	3000	1472	2464	>80	X	1140	LTML12D	01
32	3000	1840	3080	>80		1420	LTML13	01
32	3000	1840	3080	>80	X	1420	LTML13D	01
38,4	3000	2208	3696	>80		1700	LTML14	01
38,4	3000	2208	3696	>80	X	1700	LTML14D	01
44,8	3000	2576	4312	>80		1985	LTML15	01
44,8	3000	2576	4312	>80	X	1985	LTML15D	01
51,2	3000	2944	4928	>80		2265	LTML16	01
51,2	3000	2944	4928	>80	X	2265	LTML16D	01
57,6	3000	3313	5544	>80		2545	LTML17	01
57,6	3000	3313	5544	>80	X	2545	LTML17D	01
64	3000	3681	6160	>80		2825	LTML18	01
64	3000	3681	6160	>80	X	2825	LTML18D	01



Su richiesta disponibile la versione 4000°K | On request available version 4000°K | Versión con 4000°K demanda

W	L.mm	CODE	Col.
T16 SEAMLESS	14-24	LTM119	01
	21-39	LTM120	01
	28-54	LTM121	01
	28-54	LTM121D	01
	1+1x21-39	LTM122	01
	1+1x21-39	LTM122D	01
	1+1x28-54	LTM123	01
	1+1x28-54	LTM123D	01

A++-A



Su richiesta versioni Emergenza | Emergency versions on request | Versiones de emergencia a demanda



cassaforma-wallbox- caja accessory pag.156

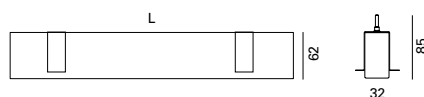



## INCASSO RASATO 3 SPOT LED

TRIMLESS RECESSED 3 LED SPOTS - TOTAL EMPOTRABLE 3 SPOT LED

 34xL+2



	W	K	lm product	lm/Led	CRI	△	Lmm	CODE	Col.	
spot LED 136lm/ mtCRI>80	3x1,5	3000	756	1050	>80	16°	304	LTMG172	01 02	  
50000h L70 B10 ta 25°C	3x1,5	3000	408	567	>80	30°	304	LTMG173	01 02	

alimentatore incluso | ballast included | con trasformador



cassaforma-wallbox- caja accessory pag.156

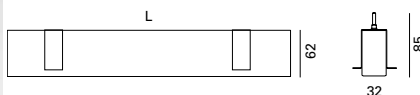



## INCASSO RASATO 6 SPOT LED

TRIMLESS RECESSED 6 LED SPOTS - TOTAL EMPOTRABLE 6 SPOT LED

 34xL+2



	W	K	lm product	lm/Led	CRI	△	Lmm	CODE	Col.	
spot LED 136lm/ mtCRI>80	6x1,5	3000	1512	2100	>80	16°	604	LTMG174	01 02	  
50000h L70 B10 ta 25°C	6x1,5	3000	816	1134	>80	30°	604	LTMG175	01 02	

alimentatore incluso | ballast included | con trasformador



cassaforma-wallbox- caja accessory pag.156

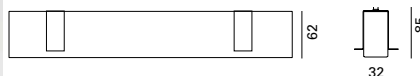

01 - bianco - white - blanco 02 - nero - black - negro



ACANTHO - AKRON - ITALY  
PROJECT: A2 ARC. GASPARRI - RICCIBITTI  
LIGHT DESIGN: FORMAT DESIGN STUDIO  
PHOTO: A. LIVERANI



## MINIFILE SOFFITTO CON DIFFUSORE

CEILING WITH DIFFUSER- TECHO CON DIFUSOR



	W	K	lm product	lm/Led	CRI	DaliT&D	L.mm	CODE	Col.
LINEAR LED 24W/MT 2200LM/MT CRI>80	12,8	3000	736	1232	>80		580	LTML19	01 02 27
	12,8	3000	736	1232	>80	X	580	LTML19D	01 02 27
	19,2	3000	1104	1848	>80		860	LTML20	01 02 27
	19,2	3000	1104	1848	>80	X	860	LTML20D	01 02 27
	25,6	3000	1472	2464	>80		1140	LTML21	01 02 27
	25,6	3000	1472	2464	>80	X	1140	LTML21D	01 02 27
	32	3000	1840	3080	>80		1420	LTML22	01 02 27
	32	3000	1840	3080	>80	X	1420	LTML22D	01 02 27
	38,4	3000	2208	3696	>80		1700	LTML23	01 02 27
	38,4	3000	2208	3696	>80	X	1700	LTML23D	01 02 27
	44,8	3000	2576	4312	>80		1985	LTML24	01 02 27
	44,8	3000	2576	4312	>80	X	1985	LTML24D	01 02 27
	51,2	3000	2944	4928	>80		2265	LTML25	01 02 27
	51,2	3000	2944	4928	>80	X	2265	LTML25D	01 02 27
50000h Ta 25° L70B10	57,6	3000	3313	5544	>80		2545	LTML26	01 02 27
	57,6	3000	3313	5544	>80	X	2545	LTML26D	01 02 27
	64	3000	3681	6160	>80		2825	LTML27	01 02 27
	64	3000	3681	6160	>80	X	2825	LTML27D	01 02 27

Su richiesta disponibile la versione 4000°K | On request available version 4000°K | Versión con 4000°K demanda

	W	L.mm	CODE	Col.
T16 SEAMLESS	14-24	593	LTM001	01 02 27
	21-39	893	LTM002	01 02 27
	21-39	893	LTM002D	01 02 27
	28-54	1193	LTM003	01 02 27
	28-54	1193	LTM003D	01 02 27
	1+1x21-39	1778	LTM004	01 02 27
	1+1x21-39	1778	LTM004D	01 02 27
	1+1x28-54	2378	LTM005	01 02 27
	1+1x28-54	2378	LTM005D	01 02 27

Su richiesta versioni Emergenza | Emergency versions on request | Versiones de emergencia a demanda



cassaforma-wallbox- caja accessory pag.156



## MINIFILE SOFFITTO 3 SPOT LED

CEILING 3 LED SPOTS - TECHO 3 SPOT LED



LED	W	K	lm product	lm/Led	CRI	∠	Lmm	CODE	Col.	
50000h L70 B10 ta 25°C	3x1,5	3000	756	1050	>80	16°	308	LTMA172	01 02	
	3x1,5	3000	408	567	>80	30°	308	LTMA173	01 02	

alimentatore incluso | ballast included | con trasformador

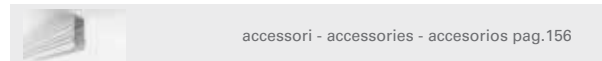
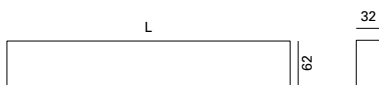

## MINIFILE SOFFITTO 6 SPOT LED

CEILING 6 LED SPOTS - TECHO 6 SPOT LED



LED	W	K	lm product	lm/Led	CRI	∠	Lmm	CODE	Col.	
50000h L70 B10 ta 25°C	6x1,5	3000	1512	2100	>80	16°	608	LTMA174	01 02	
	6x1,5	3000	816	1134	>80	30°	608	LTMA175	01 02	

alimentatore incluso | ballast included | con trasformador

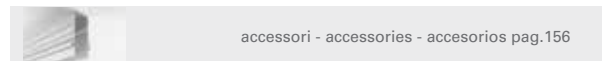
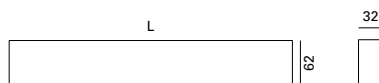



CONCESSIONARIA PEUGEOT - DENMARK



## MINIFILE SOSPENSIONE CON DIFFUSORE

SUSPENSION WITH DIFFUSER- SUSPENSION CON DIFUSOR



	W	K	lm product	lm/Led	CRI	DaliT&D	L:mm	CODE	Col.
LINEAR LED 24W/mT 2200lm/mT CRI>80	12,8	3000	736	1232	>80		580	LTML28	01 02 27
	12,8	3000	736	1232	>80	X	580	LTML28D	01 02 27
	19,2	3000	1104	1848	>80		860	LTML29	01 02 27
	19,2	3000	1104	1848	>80	X	860	LTML29D	01 02 27
	25,6	3000	1472	2464	>80		1140	LTML30	01 02 27
	25,6	3000	1472	2464	>80	X	1140	LTML30D	01 02 27
	32	3000	1840	3080	>80		1420	LTML31	01 02 27
	32	3000	1840	3080	>80	X	1420	LTML31D	01 02 27
	38,4	3000	2208	3696	>80		1700	LTML32	01 02 27
	38,4	3000	2208	3696	>80	X	1700	LTML32D	01 02 27
	44,8	3000	2576	4312	>80		1985	LTML33	01 02 27
	44,8	3000	2576	4312	>80	X	1985	LTML33D	01 02 27
	51,2	3000	2944	4928	>80		2265	LTML34	01 02 27
	51,2	3000	2944	4928	>80	X	2265	LTML34D	01 02 27
	57,6	3000	3313	5544	>80		2545	LTML35	01 02 27
	57,6	3000	3313	5544	>80	X	2545	LTML35D	01 02 27
	64	3000	3681	6160	>80		2825	LTML36	01 02 27
	64	3000	3681	6160	>80	X	2825	LTML36D	01 02 27

Su richiesta disponibile la versione 4000°K | On request available version 4000°K | Versión con 4000°K demanda

	W	L:mm	CODE	Col.
T16 SEAMLESS	14-24	593	LTM050	01 02 27
	21-39	893	LTM051	01 02 27
	28-54	1193	LTM052	01 02 27
	1+1x21-39	1778	LTM053	01 02 27
	1+1x28-54	2378	LTM054	01 02 27

Su richiesta versioni Emergenza | Emergency versions on request | Versiones de emergencia a demanda

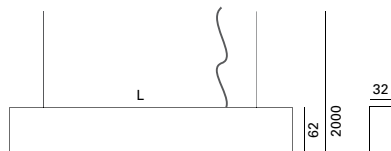



CASCIOLI - CONCESSIONARIA BMW - SAN BENEDETTO DEL TRONTO - ITALIA  
PHOTO ER STUDIO



# MINIFILE PARETE CON DIFFUSORE

PARETE CON DIFFUSORE- WALL WITH DIFFUSER- PARED CON DIFUSOR



LINEAR LED 24W/MT  
2200lm/MT CRI>80

50000h Ta  
25° L70B10



W	K	lm product	lm/Led	CRI	DaliT&D	L:mm	CODE	Col.
12,8	3000	736	1232	>80		580	LTML37	01 02 27
12,8	3000	736	1232	>80	X	580	LTML37D	01 02 27
19,2	3000	1104	1848	>80		860	LTML38	01 02 27
19,2	3000	1104	1848	>80	X	860	LTML38D	01 02 27
25,6	3000	1472	2464	>80		1140	LTML39	01 02 27
25,6	3000	1472	2464	>80	X	1140	LTML39D	01 02 27
32	3000	1840	3080	>80		1420	LTML40	01 02 27
32	3000	1840	3080	>80	X	1420	LTML40D	01 02 27
38,4	3000	2208	3696	>80		1700	LTML41	01 02 27
38,4	3000	2208	3696	>80	X	1700	LTML41D	01 02 27
44,8	3000	2576	4312	>80		1985	LTML42	01 02 27
44,8	3000	2576	4312	>80	X	1985	LTML42D	01 02 27
51,2	3000	2944	4928	>80		2265	LTML43	01 02 27
51,2	3000	2944	4928	>80	X	2265	LTML43D	01 02 27
57,6	3000	3313	5544	>80		2545	LTML44	01 02 27
57,6	3000	3313	5544	>80	X	2545	LTML44D	01 02 27
64	3000	3681	6160	>80		2825	LTML45	01 02 27
64	3000	3681	6160	>80	X	2825	LTML45D	01 02 27



Su richiesta disponibile la versione 4000°K | On request available version 4000°K | Versión con 4000°K demanda

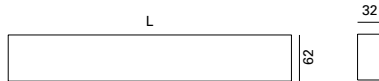

01 - bianco - white - blanco 02 - nero - black - negro 27 - ossidato alluminio - oxidised aluminium - oxidado aluminio



Sistema modulare per illuminazione diretta, diffusa e/o d'accento, composto da profili vuoti in estruso di alluminio verniciato o anodizzato 62x32 mm. di lunghezza predefinita o tagliabili a misura, disponibili nelle versioni a parete, plafone, sospensione, incasso rasato a scomparsa totale trimless o a incasso con cornice di battuta super-slim larghezza 5 mm. Da integrare con sorgenti lineari LED, spot LED e reglette per lampade fluorescenti T16 seamless, completi di alimentazione elettronica 50/60Hz 230/240V. Da completare con le testate di chiusura laterali con sistema Light Proof, schermo diffondente in policarbonato opalino bianco (per reglette fluorescenti), sagomatori in estruso di alluminio ad innesto rapido (per LED lineari e spot LED) o profili di chiusura, di lunghezza predefinita o tagliabili a misura e staffe di fissaggio o cavi di sospensione. Grado di protezione IP20 o IP40 a seconda delle combinazioni luminose prescelte.

Modular system for direct, diffused and/or accent lighting, made of 62x32 mm painted or anodised extruded aluminium empty profiles, available in predefined lengths or cut to measure. Available in wall-mounted, ceiling-mounted, suspended, trimless recessed or recessed with super-slim 5 mm. width edge trim versions. To be integrated with linear LED sources, LED spotlights and battens for seamless T16 fluorescent lamps, complete with 50/60 Hz 230/240 V electronic power supply. To be completed with Light Proof system side end caps, opal white polycarbonate diffusing screen (for fluorescent battens), quick mounting extruded aluminium shapers (for linear LEDs and spotlight LEDs) or closing profiles, available in predefined lengths or cut to measure, and mounting brackets or suspension cables. IP20 or IP40 protection degree depending on the selected lighting combinations.

Sistema modular para la iluminación directa, difusa y/o concentrada. Compuesto de perfil vacío en estruso de aluminio barnizado o anodizado 62x32 mm. de largo predefinida o cortable a medida, disponible en la versiones de pared, plafón, suspensión, totalmente empotrado "trimless" o empotrado con bordillo súper-fino "super-slim" de 5 mm. Preparados para fuentes luminosas lineales LED, spot LED y regletas para lámparas fluorescentes T16 seamless, con alimentación electrónica 50/60Hz 230/240V. Se complementan con las tapas de cierre laterales con sistema "Light Proof", difusor en policarbonato blanco opal (para regletas fluorescentes), sagomator en estruso aluminio de colocación rápida (para LED lineales y spot LED) o perfil de cierre, de longitud predefinida o cortable a medida y soporte de fijación o cables de suspensión. Grado de protección IP20 o IP40 dependiendo de las combinaciones luminosas elegidas.





## MINIFILE SISTEMA



## PROFILO VUOTO INCASSO

RECESSED EMPTY PROFILE - PERFIL VACIO EMPOTRABLE

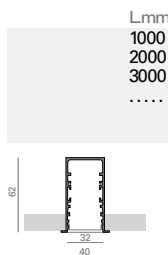

CODE	Col.
LTM0IN.1000	01 02 27
LTM0IN.2000	01 02 27
LTM0IN.3000	01 02 27
LTM0IN.misura*01	02 27

## PROFILO VUOTO INCASSO X

X-SHAPED RECESSED EMPTY PROFILE - PERFIL VACIO EMPOTRABLE X



Dim.  
595x565

CODE	Col.
LTM0IN.X	01 02 27

molle per fissare il profilo al cartongesso include |  
spring to fix the perfil to the false ceiling included |  
muelle para la fijación del perfil en el falso  
techo incluido.

## PROFILO VUOTO INCASSO 90°

90°-SHAPED RECESSED EMPTY PROFILE - PERFIL VACIO EMPOTRABLE 90°



Dim.  
315x285

CODE	Col.
LTM0IN.90	01 02 27

molle per fissare il profilo al cartongesso include |  
spring to fix the perfil to the false ceiling included |  
muelle para la fijación del perfil en el falso  
techo incluido.

## PROFILO VUOTO INCASSO T

T-SHAPED RECESSED EMPTY PROFILE - PERFIL VACIO EMPOTRABLE T



Dim.  
595x285

CODE	Col.
LTM0IN.T	01 02 27

molle per fissare il profilo al cartongesso include |  
spring to fix the perfil to the false ceiling included |  
muelle para la fijación del perfil en el falso  
techo incluido.

## COPPIA TESTATE INCASSO

COUPLE OF CLOSURE HEADS - EMPOTRADO TAPAS FINAL



CODE	Col.
LTM117	01 02 27

## PROFILO INCASSO PER PARETE/SOFFITTO

RECESSED EMPTY PROFILE FOR WALL/CEILING - EMPOTRABLE PERFIL VACIO POR PARED/TECHO



Dim.  
280+62x280+62

CODE	Col.
LTM0IN.PS	01 02 27

molle per fissare il profilo al cartongesso include |  
spring to fix the perfil to the false ceiling included |  
muelle para la fijación del perfil en el falso  
techo incluido.

## MOLLA SINGOLA INCASSO

RECESSED SINGLE SPRING - RESORTE ÚNICO EMPOTRABLE



CODE
LTM118

Molla singola per fissare il profilo lineare al  
controsoffitto. Una ogni metro lineare (minimo 2). |  
Single spring For fixing the linear profile on the  
false-ceiling. one every linear metre, 2 pieces mini-  
mum. | Resorte único para la fijación del perfil lineal  
en el falso techo. uno cada 1 mt., minimo de 2 piezas.

\*Tramite questo codice è possibile ordinare il profilo in una lunghezza lineare non standard. Sostituire alla parola "misura" la lunghezza desiderata in mm. Per ordinare un profilo con una o entrambe le estremità tagliate ad angolo 45° aggiungere alla misura la lettera "D" (taglio Destro) o "S" (taglio Sinistro). Seguire istruzioni riportate a pag. 834. Per profili oltre i 3 mt e massimo 6 mt le condizioni di trasporto sono da concordare. | | \*Through this code it's possible to order the profile in a not-standard linear length. Replace the word "misura" with the desired length in mm. To order a profile with one or both ends 45° angle-cut add the letter "D" (right cut) or "S" (left cut) to the standard or custom length. follow the instructions on page 834. for lengths over 3 mt. to max. 6 mt. transport conditions to negotiate. | | \*el uso de este código, se puede ordenar el perfil en un lineal longitud no estándar. Sustitúyase la palabra "medida" de la longitud en mm. Para pedir un perfil con uno o ambos extremos cortados en un ángulo de 45° a añadir a la medida de la letra "D" (derecha cortada) o "S" (izquierda cortada). Siga las instrucciones de la página. 834. Perfiles para más de 3 my 6 m Condiciones máximas de transporte a convenir.

## PROFILO VUOTO INCASSO RASATO

TRIMLESS RECESSED EMPTY PROFILE - PERFIL VACIO TOTAL EMPOTRABLE



Lmm	CODE	Col.
1000	LTM00R.1000	01 02 27
2000	LTM00R.2000	01 02 27
3000	LTM00R.3000	01 02 27
.....	LTM00R.misura*	01 02 27

## COPPIA DITESTATE INCASSO RASATO

COUPLE OF CLOSURE HEADS - PAREJA DE TAPAS FINALES



CODE	Col.
LTM160	01 02 27

## PROFILO VUOTO INCASSO RASATO X

X EMPTY RECESSED PROFILE- PERFIL VACIO EMPOTRABLE X

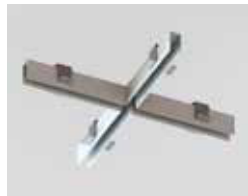

Dim.	CODE	Col.
595x565	LTM00R.X	01 02 27

staffe per fissare il profilo al cartongesso include |  
brackets to fix the perfil to the false ceiling included  
| soporte para la fijación del perfil en el falso techo  
incluido

## PROFILO RASATO PER PARETE/SOFFITTO

TRIMLESS RECESSED EMPTY PROFILE FOR WALL/CEILING - TOTAL EMPOTRABLE PERFIL VACIO POR PARED/TECHO



Dim.	CODE	Col.
280+62 x280+62	LTM00R.PS	01 02 27

staffe per fissare il profilo al cartongesso include |  
brackets to fix the perfil to the false ceiling included  
| soporte para la fijación del perfil en el falso techo  
incluido

## PROFILO VUOTO INCASSO RASATO 90

90 EMPTY TRIMLESS RECESSED PROFILE- PERFIL VACIO TOTAL EMPOTRABLE 90



Dim.	CODE	Col.
315x285	LTM00R.90	01 02 27

staffe per fissare il profilo al cartongesso include |  
brackets to fix the perfil to the false ceiling included  
| soporte para la fijación del perfil en el falso techo  
incluido

## STAFFA SINGOLA INCASSO RASATO

TRIMLESS SINGLE BRACKET- TOTAL EMPOTRABLE SOPORTE INDIVIDUAL



CODE
LTM116

Staffa singola per fissare il profilo lineare al controsoffitto. una ogni metro lineare (minimo 2)- Single bracket for fixing the linear profile on the false-ceiling. one every linear metre 2 pieces minimum- Soporte único para la fijación del lineal perfil en el falso techo. uno cada 1 mt., minimo de 2 piezas.

## PROFILO VUOTO INCASSO RASATO T

T EMPTY TRIMLESS RECESSED PROFILE- PERFIL VACIO TOTAL EMPOTRABLE T



Dim.	CODE	Col.
595x285	LTM00R.T	01 02 27

Staffe per fissare il profilo al cartongesso include |  
Brackets to fix the perfil to the false ceiling included  
| Soporte para la fijación del perfil en el falso techo  
incluido

## PROFILO VUOTO SOFFITTO

CEILING EMPTY PROFILE- PERFIL VACIO TECHO



L:mm	CODE	Col.
1000	LTM00.1000	01 02 27
2000	LTM00.2000	01 02 27
3000	LTM00.3000	01 02 27
.....	LTM00.misura*	01 02 27



## COPPIA TESTATE SOFFITTO

COUPLE OF CLOSURE HEADS FOR CEILING- HEADS PAREJA DE FINALES TECHO



per diffusore - for diffuser -por difusor  
per sagomatore - for shaper - por moldeador

CODE	Col.
LTM049P	01 02 27
LTM049S	01 02 27

## PROFILO VUOTO SOFFITTO X

X-SHAPED EMPTY PROFILE- PERFIL VACIO TECHO X



Dim.	CODE	Col.
595x565	LTM00.X	01 02 27

## PROFILO VUOTO SOFFITTO T

T-SHAPED CEILING EMPTY PROFILE - PERFIL VACIO TECHO T



Dim.	CODE	Col.
595x285	LTM00.T	01 02 27

## PROFILO VUOTO SOFFITTO 90°

90°-SHAPED CEILING EMPTY PROFILE- PERFIL VACIO TECHO 90°



Dim.	CODE	Col.
315x285	LTM00.90	01 02 27

## PROFILO VUOTO PARETE/SOFFITTO

ANGLE EMPTY PROFILE WALL-CEILING- PERFIL VACIO PARED-TECHO



Dim.	CODE	Col.
280+62 x280+62	LTM00.PS	01 02 27

01 - bianco - white - blanco 02 - nero - black - negro 27 - ossidato alluminio - oxidised aluminium - oxidado aluminio

## PROFILO VUOTO SOSPENSIONE

SUSPENSION EMPTY PROFILE- PERFIL VACIO SUSPENSION



Lmm	CODE	Col.
1000	LTM01.1000	01 02 27
2000	LTM01.2000	01 02 27
3000	LTM01.3000	01 02 27
.....	LTM01.misura*	01 02 27

## COPPIA TESTATE SOSPENSIONE

COUPLE OF CLOSURE HEADS FOR SUSPENSION- PAREJA DE FINALES SUSPENSION



per diffusore - for diffuser -por difusor  
per sagomatore - for shaper - por  
moldeador

CODE	Col.
LTM049P	01 02 27
LTM049S	01 02 27

## KIT SOSPENSIONE IN ACCIAIO L.2000MM

STEEL SUSPENSION KIT- KIT DE SUSPENSION EN ACERO



Lmm	CODE
2000	LTM047

Uno ogni 1,5 mt. minimo 2 - One every 1,5 mt, 2 pieces minimun - Uno cada 1,5 mt, mínimo de 2 piezas.

## KIT ALIMENTAZIONE COMPLETO DI ROSONE

POWER CABLE KIT WITH CEILING CANOPY- KIT ALIMENTACION CON FLORON



Dim.	Lmm	CODE	Col.
3X0,75	2000	LTM048.3	01
4X0,75	2000	LTM048.4	01
5X0,75	2000	LTM048.5	01
7X0,75	2000	LTM048.7	01
9X0,75	2000	LTM048.9	01

## PROFILO VUOTO PARETE

WALL EMPTY PROFILE- PERFIL VACIO PARED



Lmm	CODE	Col.
1000	LTM02.1000	01 02 27
2000	LTM02.2000	01 02 27
3000	LTM02.3000	01 02 27
.....	LTM02.misura*	01 02 27

## COPPIA TESTATE PARETE

COUPLE OF CLOSURE HEADS - PAREJA DE TAPAS FINALES PARED



per diffusore - for diffuser -por difusor  
per sagomatore - for shaper - por  
moldeador

CODE	Col.
LTM049P	01 02 27
LTM049S	01 02 27

\*Tramite questo codice è possibile ordinare il profilo in una lunghezza lineare non standard. Sostituire alla parola "misura" la lunghezza desiderata in mm. Per ordinare un profilo con una o entrambe le estremità tagliate ad angolo 45° aggiungere alla misura la lettera "D" (taglio Destro) o "S" (taglio Sinistro). Seguire istruzioni riportate a pag. 834. Per profili oltre i 3 mt e massimo 6 mt le condizioni di trasporto sono da concordare. || \*Through this code it's possible to order the profile in a not-standard linear length. Replace the word "misura" with the desired length in mm. To order a profile with one or both ends 45° angle-cut add the letter "D" (right cut) or "S" (left cut) to the standard or custom length. follow the instructions on page 834. for lengths over 3 mt. to max. 6 mt. transport conditions to negotiate. || \*el uso de este código, se puede ordenar el perfil en un lineal longitud no estándar. Sustitúyase la palabra "medida" de la longitud en mm. Para pedir un perfil con uno o ambos extremos cortados en un ángulo de 45° a añadir a la medida de la letra "D" (derecha cortada) o "S" (izquierda cortada). Siga las instrucciones de la página. 834. Perfiles para más de 3 my 6 m Condiciones máximas de transporte a convenir.

## SPOT LED 1



	W	K	lm product	lm/Led	CRI	△	Lmm	CODE	Col.	
SPOT LED 136lm/ mtCRI>80	1x1,5	3000	252	350	>80	16°	300	<b>LTM170</b>	<b>01 02</b>	
	1x1,5	3000	136	189	>80	30°	300	<b>LTM171</b>	<b>01 02</b>	
50000h L70 B10 ta 25°C <b>A+</b>										
Alimentatore incluso   Ballast included   Con trasformador										

## SPOT LED 3



	W	K	lm product	lm/Led	CRI	△	Lmm	CODE	Col.	
SPOT LED 136lm/ mtCRI>80	3x1,5	3000	756	1050	>80	16°	300	<b>LTM172</b>	<b>01 02</b>	
	3x1,5	3000	408	567	>80	30°	300	<b>LTM173</b>	<b>01 02</b>	
50000h L70 B10 ta 25°C <b>A+</b>										
Alimentatore incluso   Ballast included   Con trasformador										





## SPOT LED 6



	W	K	lm product	lm/Led	CRI	△	Lmm	CODE	Col.	
SPOT LED 136lm/ mtCRI>80	6x1,5	3000	1512	2100	>80	16°	600	<b>LTM174</b>	<b>01 02</b>	
	6x1,5	3000	816	1134	>80	30°	600	<b>LTM175</b>	<b>01 02</b>	
50000h L70 B10 ta 25°C <b>A+</b>										
Alimentatore incluso   Ballast included   Con trasformador										



## MINIFILE REGLETTE LED 24W/MT

24W/MT LED BATTEN- REGLETTE LED 24W/MT

	W	K	Im product	Im/Led	CRI	DaliT&D	Lmm	CODE	
 <p>LINEAR LED 24W/MT 2200LM/MT CRI&gt;80 230V</p> <p>50000h Ta 25° L70B10</p> <p><b>A+</b></p>	1x12,8	3000	1232	1232	>80		560	RLM3M01	
	1x12,8	3000	1232	1232	>80	x	560	RLM3M01D	
	1x19,2	3000	1848	1848	>80		840	RLM3M02	
	1x19,2	3000	1848	1848	>80	x	840	RLM3M02D	
	1x25,6	3000	2464	2464	>80		1120	RLM3M03	
	1x25,6	3000	2464	2464	>80	x	1120	RLM3M03D	
	1x32	3000	3080	3080	>80		1400	RLM3M04	
	1x32	3000	3080	3080	>80	x	1400	RLM3M04D	
	1x38,4	3000	3696	3696	>80		1680	RLM3M05	
	1x38,4	3000	3696	3696	>80	x	1680	RLM3M05D	
	1x51,2	3000	4928	4928	>80		2240	RLM3M07	
	1x51,2	3000	4928	4928	>80	x	2240	RLM3M07D	
									
	 <p>LINEAR LED 24W/MT 2285LM/MT CRI&gt;80</p> <p>50000h Ta 25° L70B10</p> <p><b>A+</b></p>	1x12,8	4000	1280	1280	>80		560	RLM4M01
1x12,8		4000	1280	1280	>80	x	560	RLM4M01D	
1x19,2		4000	1920	1920	>80		840	RLM4M02	
1x19,2		4000	1920	1920	>80	x	840	RLM4M02D	
1x25,6		4000	2560	2560	>80		1120	RLM4M03	
1x25,6		4000	2560	2560	>80	x	1120	RLM4M03D	
1x32		4000	3200	3200	>80		1400	RLM4M04	
1x32		4000	3200	3200	>80	x	1400	RLM4M04D	
1x38,4		4000	3840	3840	>80		1680	RLM4M05	
1x38,4		4000	3840	3840	>80	x	1680	RLM4M05D	
1x51,2		4000	5120	5120	>80		2240	RLM4M07	
1x51,2		4000	5120	5120	>80	x	2240	RLM4M07D	
									

## MINIFILE REGLETTE FLUO SEAMLESS

FLUO SEAMLESS BATTEN - REGLETTE FLUO SEAMLESS

	W	Lmm	CODE	
 <p>T16 SEAMLESS</p> <p><b>A+</b></p>	14-24	585	LTM034	
	14-24	585	LTM034D	
	21-39	885	LTM035	
	21-39	885	LTM035D	
	28-54	1185	LTM036	
	28-54	1185	LTM036D	
	1+1x21-39	1770	LTMB34	
	1+1x21-39	1770	LTMB34D	
	1+1x28-54	2370	LTMB35	
	1+1x28-54	2370	LTMB35D	
				

## LAMPADE FLUO SEAMLESS T16 G5

SEAMLESS FLUO G5 T16 LAMPS- LAMPARAS FLUO SEAMLESS T16 G5

	W	K	CODE
 <p>T16 SEAMLESS</p> <p><b>A+</b></p>	14	3000	LT9883.14.830
	14	4000	LT9883.14.840
	21	3000	LT9883.21.830
	21	4000	LT9883.21.840
	24	3000	LT9883.24.830
	24	4000	LT9883.24.840
	28	3000	LT9883.28.830
	28	4000	LT9883.28.840
	35	3000	LT9883.35.830
	35	4000	LT9883.35.840
	39	3000	LT9883.39.830
	39	4000	LT9883.39.840
	49	3000	LT9883.49.830
	49	4000	LT9883.49.840
	54	3000	LT9883.54.830
	54	4000	LT9883.54.840
	80	3000	LT9883.80.830
	80	4000	LT9883.80.840

## STRIP BOBINA DA 5 METRI

STRIP LED 5 METERS ROLL- BOBINA STRIP LED 5 METROS



LINEAR LED 24V	W/mt	V	Led/mt	lm/mt	K	lm product	lm/W	CRI	IP	A	Lmm	Kg	CODE
A+	5,5	24	60	270	3000	1350	245	80	20	V.1	5000	0,18	ST05.30.5
	9,6	24	120	540	3000	2700	281	80	20	V.1	5000	0,18	ST10.30.5
	11	24	180	1200	3000	6000	545	80	20	V.1	5000	0,18	ST11.30.5
	18	24	168	2200	3000	11000	611	80	20	V.1	5000	0,18	ST21.30.5

LINEAR LED IP65 24V	W/mt	V	Led/mt	lm/mt	K	lm product	lm/W	CRI	IP	A	Lmm	Kg	CODE
A+	9,6	24	120	540	3000	2700	281	80	65	V.1	5000	0,18	ST10.30.5IP
	14,4	24	60	900	3000	4500	313	80	65	V.1	5000	0,18	ST15.30.5IP
	19,2	24	240	1080	3000	5400	281	80	65	V.1	5000	0,18	ST20.30.5IP

## MINIFILE DISSIPATORE PER STRIP LED

HEATSINK FOR STRIPLED- DISIPADOR PARA STRIP LED



	Lmm	CODE
	1000	LITMC.1000
	2000	LITMC.2000
	3000	LITMC.3000
	.....	LITMC.misura*

\*Tramite questo codice è possibile ordinare il profilo in una lunghezza lineare non standard. Sostituire alla parola "misura" la lunghezza desiderata in mm. Per profili oltre i 3 mt e massimo 6 mt le condizioni di trasporto sono da concordare. | \*Through this code it's possible to order the profile in a not-standard linear length. Replace the word "misura" with the desired length in mm. | \*el uso de este código, se puede ordenar el perfil en un lineal longitud no estándar. Sustitúyase la palabra "medida" de la longitud en mm. Perfiles para más de 3 my 6 m Condiciones máximas de transporte a convenir.

## LEVA MODULO 3

3 LAMPS MODULE - MODULO 3 LAMPARA

UGR < 19



LED	W	K	lm product	lm/Led	CRI	Dali	∠	Dim.	CODE	Col.
3SDCM 50000h L90 B10 Ta 25°C A+	3x1,5	2700	588	504	95		19°	275x240	LV102.927S	01 02 41 42
	3x1,5	2700	588	504	95	x	19°	275x240	LV102.927SD	01 02 41 42
	3x1,5	2700	423	504	95		33°	275x240	LV102.927F	01 02 41 42
	3x1,5	2700	423	504	95	x	33°	275x240	LV102.927FD	01 02 41 42
	3x1,5	2700	465	504	95		56°	275x240	LV102.927W	01 02 41 42
	3x1,5	2700	465	504	95	x	56°	275x240	LV102.927WD	01 02 41 42
	3x1,5	3000	588	504	95		19°	275x240	LV102.930S	01 02 41 42
	3x1,5	3000	588	504	95	x	19°	275x240	LV102.930SD	01 02 41 42
	3x1,5	3000	423	504	95		33°	275x240	LV102.930F	01 02 41 42
	3x1,5	3000	423	504	95	x	33°	275x240	LV102.930FD	01 02 41 42
	3x1,5	3000	465	504	95		56°	275x240	LV102.930W	01 02 41 42
	3x1,5	3000	465	504	95	x	56°	275x240	LV102.930WD	01 02 41 42
	3x1,5	4000	588	504	95		19°	275x240	LV102.940S	01 02 41 42
	3x1,5	4000	588	504	95	x	19°	275x240	LV102.940SD	01 02 41 42
	3x1,5	4000	423	504	95		33°	275x240	LV102.940F	01 02 41 42
	3x1,5	4000	423	504	95	x	33°	275x240	LV102.940FD	01 02 41 42
	3x1,5	4000	465	504	95		56°	275x240	LV102.940W	01 02 41 42
	3x1,5	4000	465	504	95	x	56°	275x240	LV102.940WD	01 02 41 42

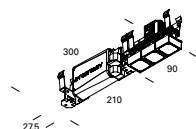

- 01 - telaio bianco - ottica nera - white box - black optic - marco blanco optica negra
- 02 - telaio nero - ottica nera - black box - black optic - marco negro - optica negra
- 41 - telaio bianco - ottica bianca - white box - white optic - marco blanco - optica blanca
- 42 - telaio nero - ottica dorata - black box - golden optic - marco negro - optica dorada



pag.824



pag.820



# LEVA MODULO 5

5 LAMPS MODULE - MODULO 5 LAMPARA

UGR < 19



LED	W	K	lm product	lm/Led	CRI	Dali	∠	Dim.	CODE	Col.
	5x1,5	2700	980	840	95		19°	275x300	LV103.927S	01 02 41 42
	5x1,5	2700	980	840	95	x	19°	275x300	LV103.927SD	01 02 41 42
	5x1,5	2700	705	840	95		33°	275x300	LV103.927F	01 02 41 42
	5x1,5	2700	705	840	95	x	33°	275x300	LV103.927FD	01 02 41 42
	5x1,5	2700	775	840	95		56°	275x300	LV103.927W	01 02 41 42
	5x1,5	2700	775	840	95	x	56°	275x300	LV103.927WD	01 02 41 42
	5x1,5	3000	980	840	95		19°	275x300	LV103.930S	01 02 41 42
	5x1,5	3000	980	840	95	x	19°	275x300	LV103.930SD	01 02 41 42
	5x1,5	3000	705	840	95		33°	275x300	LV103.930F	01 02 41 42
	5x1,5	3000	705	840	95	x	33°	275x300	LV103.930FD	01 02 41 42
	5x1,5	3000	775	840	95		56°	275x300	LV103.930W	01 02 41 42
	5x1,5	3000	775	840	95	x	56°	275x300	LV103.930WD	01 02 41 42
	5x1,5	4000	980	840	95		19°	275x300	LV103.940S	01 02 41 42
	5x1,5	4000	980	840	95	x	19°	275x300	LV103.940SD	01 02 41 42
	5x1,5	4000	705	840	95		33°	275x300	LV103.940F	01 02 41 42
	5x1,5	4000	705	840	95	x	33°	275x300	LV103.940FD	01 02 41 42
	5x1,5	4000	775	840	95		56°	275x300	LV103.940W	01 02 41 42
	5x1,5	4000	775	840	95	x	56°	275x300	LV103.940WD	01 02 41 42

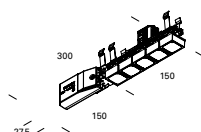

3SDCM  
50000h L90  
B10 Ta 25°C



# LEVA MODULO 10

10 LAMPS MODULE - MODULO 10 LAMPARA

UGR < 19



LED	W	K	lm product	lm/Led	CRI	Dali	∠	Dim.	CODE	Col.
	10x1,5	2700	1960	1680	95		19°	275x450	LV104.927S	01 02 41 42
	10x1,5	2700	1960	1680	95	x	19°	275x450	LV104.927SD	01 02 41 42
	10x1,5	2700	1410	1680	95		33°	275x450	LV104.927F	01 02 41 42
	10x1,5	2700	1410	1680	95	x	33°	275x450	LV104.927FD	01 02 41 42
	10x1,5	2700	1550	1680	95		56°	275x450	LV104.927W	01 02 41 42
	10x1,5	2700	1550	1680	95	x	56°	275x450	LV104.927WD	01 02 41 42
	10x1,5	3000	1960	1680	95		19°	275x450	LV104.930S	01 02 41 42
	10x1,5	3000	1960	1680	95	x	19°	275x450	LV104.930SD	01 02 41 42
	10x1,5	3000	1410	1680	95		33°	275x450	LV104.930F	01 02 41 42
	10x1,5	3000	1410	1680	95	x	33°	275x450	LV104.930FD	01 02 41 42
	10x1,5	3000	1550	1680	95		56°	275x450	LV104.930W	01 02 41 42
	10x1,5	3000	1550	1680	95	x	56°	275x450	LV104.930WD	01 02 41 42
	10x1,5	4000	1960	1680	95		19°	275x450	LV104.940S	01 02 41 42
	10x1,5	4000	1960	1680	95	x	19°	275x450	LV104.940SD	01 02 41 42
	10x1,5	4000	1410	1680	95		33°	275x450	LV104.940F	01 02 41 42
	10x1,5	4000	1410	1680	95	x	33°	275x450	LV104.940FD	01 02 41 42
	10x1,5	4000	1550	1680	95		56°	275x450	LV104.940W	01 02 41 42
	10x1,5	4000	1550	1680	95	x	56°	275x450	LV104.940WD	01 02 41 42

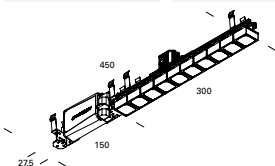

3SDCM  
50000h L90  
B10 Ta 25°C



- 01 - telaio bianco - ottica nera - white box - black optic - marco blanco optica negra
- 02 - telaio nero - ottica nera - black box - black optic - marco negro - optica negra
- 41 - telaio bianco - ottica bianca - white box - white optic - marco blanco - optica blanca
- 42 - telaio nero - ottica dorata - black box - golden optic - marco negro - optica dorada

## LEVA MODULO 15 PER/FOR/POR MINIFILE SYSTEM

5 LAMPS MODULE - MODULO 15 LAMPARA

	W	K	lm product	lm/Led	CRI	Dali	∠	Dim.	CODE	Col.
	15x1,5	2700	2940	2520	95		10°	275x750	LV105.927S	01 02 41 42
	15x1,5	2700	2940	2520	95	x	10°	275x750	LV105.927SD	01 02 41 42
	15x1,5	2700	2115	2520	95		30°	275x750	LV105.927F	01 02 41 42
	15x1,5	2700	2115	2520	95	x	30°	275x750	LV105.927FD	01 02 41 42
	15x1,5	2700	2325	2520	95		40°	275x750	LV105.927W	01 02 41 42
	15x1,5	2700	2325	2520	95	x	40°	275x750	LV105.927WD	01 02 41 42
	15x1,5	3000	2940	2520	95		10°	275x750	LV105.930S	01 02 41 42
	15x1,5	3000	2940	2520	95	x	10°	275x750	LV105.930SD	01 02 41 42
	15x1,5	3000	2115	2520	95		30°	275x750	LV105.930F	01 02 41 42
	15x1,5	3000	2115	2520	95	x	30°	275x750	LV105.930FD	01 02 41 42
	15x1,5	3000	2325	2520	95		40°	275x750	LV105.930W	01 02 41 42
	15x1,5	3000	2325	2520	95	x	40°	275x750	LV105.930WD	01 02 41 42
	15x1,5	4000	2940	2520	95		10°	275x750	LV105.940S	01 02 41 42
	15x1,5	4000	2940	2520	95	x	10°	275x750	LV105.940SD	01 02 41 42
	15x1,5	4000	2115	2520	95		30°	275x750	LV105.940F	01 02 41 42
	15x1,5	4000	2115	2520	95	x	30°	275x750	LV105.940FD	01 02 41 42
	15x1,5	4000	2325	2520	95		40°	275x750	LV105.940W	01 02 41 42
	15x1,5	4000	2325	2520	95	x	40°	275x750	LV105.940WD	01 02 41 42

3SDCM  
50000h L90  
B10 Ta 25°C

A+

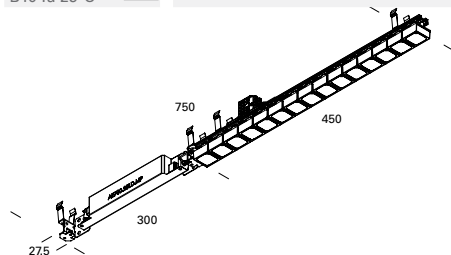

## COPPIA SAGOMATORI IN ESTRUSO DI ALLUMINIO

EXTRUDED ALUMINIUM COUPLE OF SHAPERS- PAREJA DE MOLDEADORES EN EXTRUSO DE ALUMINIO

	Lmm	CODE	Col.
	1000	LTM045.1000	01 02 27
	2000	LTM045.2000	01 02 27
	3000	LTM045.3000	01 02 27
	.....	LTM045.misura*	01 02 27

## DIFFUSORE IN POLICARBONATO OPALINO BIANCO

OPAL WHITE POLYCARBONATE DIFFUSER- DIFUSOR OPALINO BLANCO EN POLICARBONATO

	Lmm	CODE	Col.
	1000	LTM044.1000	
	2000	LTM044.2000	
	3000	LTM044.3000	
	.....	LTM044.misura*	

## MINIFILE PROFILO DI CHIUSURA IN ESTRUSO DI ALLUMINIO

EXTRUDED ALUMINIUM CLOSING COVER- TAPA EN EXTRUSO DE ALUMINIO

	Lmm	CODE	Col.
	1000	LTM044.1000	01 02 27
	2000	LTM044.2000	01 02 27
	3000	LTM044.3000	01 02 27
	.....	LTM044.misura*	01 02 27

- 01 - telaio bianco - ottica nera - white box - black optic - marco blanco optica negra
 ■ 02 - telaio nero - ottica nera - black box - black optic - marco negro - optica negra
- 41 - telaio bianco - ottica bianca - white box - white optic - marco blanco - optica blanca
 ■ 42 - telaio nero - ottica dorata - black box - golden optic - marco negro - optica dorada

## PROFILO DI CHIUSURA IN ESTRUSO DI ALLUMINIO PER SAGOMATORE

EXTRUDED ALUMINIUM CLOSING COVER FOR SHAPER- TAPA EN EXTRUSO DE ALUMINIO POR MOLDEADOR



Lmm  
1000  
2000  
3000  
.....

CODE	Col.
LTVMS.1000	01 02
LTVMS.2000	01 02
LTVMS.3000	01 02
LTVMS.misura*	01 02

## COPPIA GIUNTI LINEARI

LINEAR JOINT COUPLE- KIT DE UNION LINEAL



CODE  
LTM211

## COPPIA GIUNTI ANGOLARI

ANGLE CONNECTOR COUPLE- CONNECTOR ANGULO



CODE  
LTM211.90

## COPPIA GIUNTI ANGOLARI PARETE/SOFFITTO

ANGLE CONNECTOR COUPLE FOR WALL-CEILING CONNECTION - CONNECTOR ANGULO PARED-TECHO



CODE  
LTM211.90P

\*Tramite questo codice è possibile ordinare il profilo in una lunghezza lineare non standard. Sostituire alla parola "misura" la lunghezza desiderata in mm. Per ordinare un profilo con una o entrambe le estremità tagliate ad angolo 45° aggiungere alla misura la lettera "D" (taglio Destro) o "S" (taglio Sinistro). Seguire istruzioni riportate a pag. 652. Per profili oltre i 3 mt e massimo 6 mt le condizioni di trasporto sono da concordare. || \*Through this code it's possible to order the profile in a not-standard linear length. Replace the word "misura" with the desired length in mm. To order a profile with one or both ends 45° angle-cut add the letter "D" (right cut) or "S" (left cut) to the standard or custom length. follow the instructions on page 652. for lengths over 3 mt. to max. 6 mt. transport conditions to negotiate. || \*el uso de este código, se puede ordenar el perfil en un lineal longitud no estándar. Sustitúyase la palabra "medida" de la longitud en mm. Para pedir un perfil con uno o ambos extremos cortados en un ángulo de 45 ° a añadir a la medida de la letra "D" (derecha cortada) o "S" (izquierda cortada). Siga las instrucciones de la página. 652. Perfiles para más de 3 my 6 m Condiciones máximas de transporte a convenir.

## CASSAFORMA/CONTAINER MINIFILE

MINIFILE WALLBOX- MINIFILE ENCOFRADO



Dim.	H	Lmm	CODE	Col.
49	94	1000	LTMF1000	01 02 27
49	94	2000	LTMF2000	01 02 27
49	94	3000	LTMF3000	01 02 27
49	94	.....	LTMFmisura*	01 02 27



## COPPIA DITESTATE

COUPLE OF CLOSURE HEADS TAPAS FINAL



CODE	Col.
LTM200	01 02 27

## CASSAFORMA GIUNTO X

X-SHAPED BRICK WALL/PLASTERBOARD EMPTY PROFILE- PERFIL VACIO LADRILLO/CARTON-YESO X



Dim.	CODE	Col.
595 x 565	LTMFX	01 02 27

## CASSAFORMA PARETE/SOFFITTO

WALL/CEILING EMPTY PROFILE - PERFIL VACIO PARED/TECHO



Dim.	CODE	Col.
280+94 x 280+94	LTMFPS	01 02 27

## CASSAFORMA GIUNTO 90°

90°-SHAPED BRICK WALL/PLASTERBOARD EMPTY PROFILE- PERFIL VACIO LADRILLO/CARTON-YESO 90°



Dim.	CODE	Col.
315 x 285	LTMF90	01 02 27

## CASSAFORMA GIUNTO T

T-SHAPED BRICK WALL/PLASTERBOARD EMPTY PROFILE - PERFIL VACIO LADRILLO/CARTON-YESO T



Dim.	CODE	Col.
565 x 315	LTMFT	01 02 27

\*Tramite questo codice è possibile ordinare il profilo in una lunghezza lineare non standard. Sostituire alla parola "misura" la lunghezza desiderata in mm. Per ordinare un profilo con una o entrambe le estremità tagliate ad angolo 45° aggiungere alla misura la lettera "D" (taglio Destro) o "S" (taglio Sinistro). Seguire istruzioni riportate a pag. 834. Per profili oltre i 3 mt e massimo 6 mt le condizioni di trasporto sono da concordare. || \*Through this code it's possible to order the profile in a not-standard linear length. Replace the word "misura" with the desired length in mm. To order a profile with one or both ends 45° angle-cut add the letter "D" (right cut) or "S" (left cut) to the standard or custom length. Follow the instructions on page 834. for lengths over 3 mt. to max. 6 mt. transport conditions to negotiate. || \*el uso de este código, se puede ordenar el perfil en un lineal longitud no estándar. Sustitúyase la palabra "medida" de la longitud en mm. Para pedir un perfil con uno o ambos extremos cortados en un ángulo de 45° a añadir a la medida de la letra "D" (derecha cortada) o "S" (izquierda cortada). Siga las instrucciones de la página. 834. Perfiles para más de 3 my 6 m Condiciones máximas de transporte a convenir.

## GIUNTI LINEARI COPPIA

LINEAR JOINT COUPLE FOR WALLBOX- CAJA PAREJA DE LINEAL UNION



CODE  
LTM211

## GIUNTI ANGOLARI COPPIA

ANGLE CONNECTORS COUPLE- CONNECTOR ANGULO PAREJA



CODE  
LTM211.90

## COPPIA DI STAFFE DI FISSAGGIO PER CARTONGESSO

COUPLE OF FIXING BRACKETS IN THE FALSE-CEILING - PAREJA DE SOPORTES PARA FIJACIÓN EN FALSO TECHO



CODE  
LTSC01

Coppia di staffe di fissaggio per cartongesso 1 ogni 1,5 mt. (minimo 2 pezzi) - couple of fixing brackets in the false-ceiling 1 per 0,5 mt. (min. 2 pcs)- pareja de soportes para fijación en falso techo 1 por 1,5 mt. minimo 2 piezas.

## STAFFA SINGOLA PER FISSAGGIO MODULO LUMINOSO LEVA SOFFITTO E MINIFILE SOFFITTO

LIGHTING MODULE LEVA CEILING & MINIFILE CEILING FIXING SINGLE BRACKET- SOPORTE INDIVIDUAL POR LEVA TECHO Y MINIFILE TECHO



CODE  
LTM210

staffa per fissaggio modulo luminoso all'interno della cassaforma. ordinare 1 al mt. (minimo 2 pezzi) | Single bracket to fix the lighting module within the wallbox, order 1 per mt. (min. 2 pcs) | soporte individual por fijar el encofrado, solicite 1 por mt. (minimo 2 piezas)

## FASCETTA REGGICAVO PER CASSAFORMA

FASCETTA REGGICAVO- TIE CABLE LOCKING- ABRAZADERA DE CABLE



CODE  
LTSC02

Fascetta reggicavo - ordinare 1 ogni 0,5 mt (minimo 2pezzi) - Tie cable locking - order 1 per 0,5 mt. (min.2pcs) - Abrazadera de cable - solicite 1 por 0,5 mt. (2pcs mínimo)

---

Serie di apparecchi da semi-incasso, a plafone e a sospensione per illuminazione diretta diffusa. Per sorgenti lineari LED o lampade fluorescenti T16 seamless. Alimentazione elettronica integrata 50/60Hz 230/240V. Disponibili come moduli finiti o come moduli da assemblare a sistema. Corpo in estruso di alluminio, finitura verniciata o anodizzata. Schermo diffondente in policarbonato opalino bianco e testate di chiusura laterali con sistema Light Proof. Grado di protezione IP40 o IP43 a seconda del tipo d'installazione.

Series of semi-recessed, ceiling-mounted or suspended fixtures for direct diffused lighting. For linear LED sources or T16 fluorescent seamless lamps. 230/240V 50/60Hz integrated electronic supply. Available both as default modules and as modules to be assembled in a system. Body in extruded aluminium, painted or anodized finish. Opal white polycarbonate diffuser and Light Proof system side-end caps. Degree of protection IP40 or IP43, according to the way that it is installed.

Serie de aparatos semi-empotrables, a plafón y a suspensión para la iluminación directa difuminada. Para fuentes de luz LED o lámparas fluorescentes T16 seamless. Alimentación electrónica integrada 50/60Hz 230/240V. Disponibles como aparatos completos o como módulos a ensamblar (sistema). Cuerpo en estruso de aluminio, acabado barnizado o anodizado. Difusor en policarbonato opal blanco y tapas de cierre laterales con sistema Light Proof. Grado de protección IP40 o IP43 según el tipo de instalación.

---

## MINIFILE OPENLIGHT





TABAKALERA - CENTRO INTERNACIONAL DE CULTURA CONTEMPORÁNEA - SPAIN  
LIGHTING PROJECT TAO ILLUMINACION





## SEZIONI PROFILO MINIFILE OPENLIGHT

SEMI INCASSO - SEMI-RECESSED - SEMI EMPOTRADO

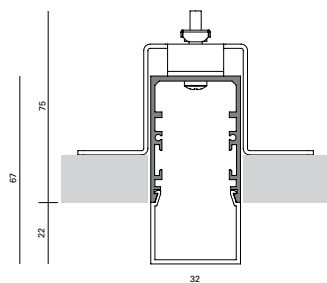

SOFFITTO - CEILING MOUNTED - TECHO

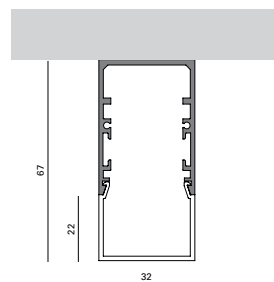

SOSPENSIONE - SUSPENSION - SUSPENSION

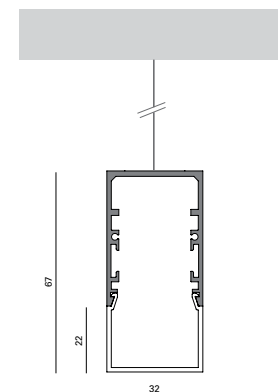

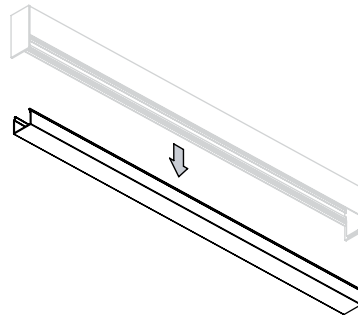
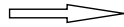
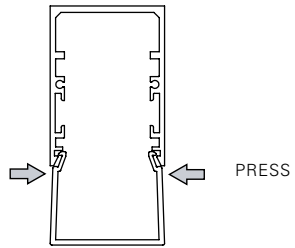
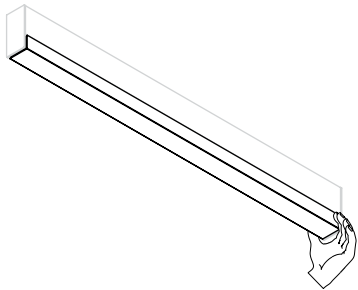
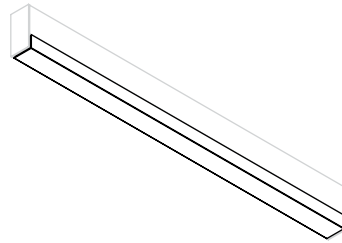
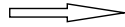
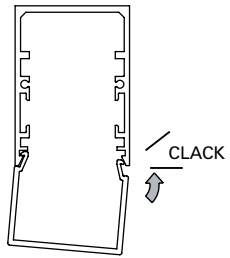
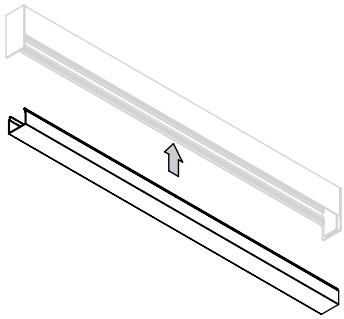

## MINIFILE OPENLIGHT SEMI INCASSO

34xL+2

SEMI-RECESSED WITH DIFFUSER- SEMI EMPOTRADO CON DIFUSOR



	W	K	lm/product	lm/Led	CRI	Dali	Lmm	CODE	Col.
LINEAR LED 24W/MT 2200lm/MT CRI>80	12,8	3000	736	1232	>80		580	MO030	01 27
	12,8	3000	736	1232	>80	x	580	MO030D	01 27
	19,2	3000	1104	1848	>80		860	MO031	01 27
	19,2	3000	1104	1848	>80	x	860	MO031D	01 27
	25,6	3000	1472	2464	>80		1140	MO032	01 27
	25,6	3000	1472	2464	>80	x	1140	MO032D	01 27
	32	3000	1840	3080	>80		1420	MO033	01 27
	32	3000	1840	3080	>80	x	1420	MO033D	01 27
	38,4	3000	2208	3696	>80		1700	MO034	01 27
	38,4	3000	2208	3696	>80	x	1700	MO034D	01 27
50000h Ta 25° L70B10	A+								



Su richiesta disponibile la versione 4000K | On request available 4000K version | Versión con 4000K a demanda.

	W	Dali	Lmm	CODE	Col.
T16 SEAMLESS	14-24		593	MO035	01 27
	14-24	x	593	MO035D	01 27
	21-39		893	MO036	01 27
	21-39	x	893	MO036D	01 27
	28-54		1193	MO037	01 27
	28-54	x	1193	MO037D	01 27
	1+1x21-39		1778	MO038	01 27
	1+1x21-39	x	1778	MO038D	01 27
	1+1x28-54		2378	MO039	01 27
	1+1x28-54	x	2378	MO039D	01 27
	A+-A				



Su richiesta versioni Emergenza | Emergency versions on request | Versiones de emergencia a demanda

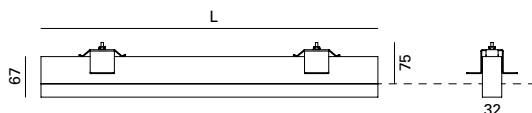

## MINIFILE OPENLIGHT SOFFITTO

CEILING WITH DIFFUSER - TECHO CON DIFUSOR



	W	K	lm product	lm/Led	CRI	Dali	Lmm	CODE	Col.
LINEAR LED 24W/MT 2200lm/MT CRI>80	12,8	3000	736	1232	>80		580	MO020	01 27
	12,8	3000	736	1232	>80	x	580	MO020D	01 27
	19,2	3000	1104	1848	>80		860	MO021	01 27
	19,2	3000	1104	1848	>80	x	860	MO021D	01 27
	25,6	3000	1472	2464	>80		1140	MO022	01 27
	25,6	3000	1472	2464	>80	x	1140	MO022D	01 27
	32	3000	1840	3080	>80		1420	MO023	01 27
	32	3000	1840	3080	>80	x	1420	MO023D	01 27
	38,4	3000	2208	3696	>80		1700	MO024	01 27
	38,4	3000	2208	3696	>80	x	1700	MO024D	01 27
50000h Ta 25° L70B10	A+								



Su richiesta disponibile la versione 4000°K | On request available version 4000°K | Versión con 4000K a demanda

	W	Dali	Lmm	CODE	Col.
T16 SEAMLESS	14-24		593	MO025	01 27
	14-24	x	593	MO025D	01 27
	21-39		893	MO026	01 27
	21-39	x	893	MO026D	01 27
	28-54		1193	MO027	01 27
	28-54	x	1193	MO027D	01 27
	1+1x21-39		1778	MO028	01 27
	1+1x21-39	x	1778	MO028D	01 27
	1+1x28-54		2378	MO029	01 27
	1+1x28-54	x	2378	MO029D	01 27
	A+-A				



Su richiesta versioni Emergenza | Emergency versions on request | Versiones de emergencia a demanda

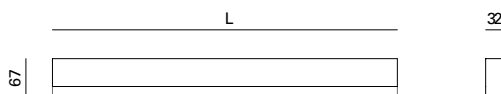

## MINIFILE OPENLIGHT SOSPENSIONE CON DIFFUSORE

SUSPENSION WITH DIFFUSER- SOSPENSION CON DIFUSOR

	W	K	lm product	lm/Led	CRI	Dali	Lmm	CODE	Col.	
	LINEAR LED 24W/MT 2200LM/MT CRI>80	12,8	3000	736	1232	>80	580	MO040	01 27	
		12,8	3000	736	1232	>80	580	MO040D	01 27	
		19,2	3000	1104	1848	>80	860	MO041	01 27	
		19,2	3000	1104	1848	>80	860	MO041D	01 27	
		25,6	3000	1472	2464	>80	1140	MO042	01 27	
		25,6	3000	1472	2464	>80	1140	MO042D	01 27	
		32	3000	1840	3080	>80	1420	MO043	01 27	
		32	3000	1840	3080	>80	1420	MO043D	01 27	
		38,4	3000	2208	3696	>80	1700	MO044	01 27	
		38,4	3000	2208	3696	>80	1700	MO044D	01 27	
	50000h Ta 25° L70B10									
	A+									

Su richiesta disponibile la versione 4000°K | On request available version 4000°K | Versión con 4000°K demanda

	W	Dali	Lmm	CODE	Col.
	T16 SEAMLESS				
	14-24	x	593	MO045	01 27
	14-24	x	593	MO045D	01 27
	21-39		893	MO046	01 27
	21-39	x	893	MO046D	01 27
	28-54		1193	MO047	01 27
	28-54	x	1193	MO047D	01 27
	1+1x21-39		1778	MO048	01 27
	1+1x21-39	x	1778	MO048D	01 27
	1+1x28-54		2378	MO049	01 27
	1+1x28-54	x	2378	MO049D	01 27
A+-A					

Su richiesta versioni Emergenza | Emergency versions on request | Versiones de emergencia a demanda

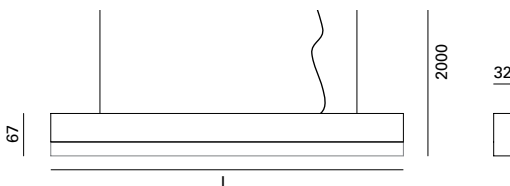

## MINIFILE OPENLIGHT TRACK CON DIFFUSORE

TRACK WITH DIFFUSER- TRACK CON DIFUSOR

	W	K	lm product	lm/Led	CRI	Dali	Lmm	CODE	Col.	
	LINEAR LED 24W/MT 2200LM/MT CRI>80	12,8	3000	736	1232	>80	580	MO120	01 27	
		12,8	3000	736	1232	>80	580	MO120D	01 27	
		19,2	3000	1104	1848	>80	860	MO121	01 27	
		19,2	3000	1104	1848	>80	860	MO121D	01 27	
		25,6	3000	1472	2464	>80	1140	MO122	01 27	
		25,6	3000	1472	2464	>80	1140	MO122D	01 27	
		32	3000	1840	3080	>80	1420	MO123	01 27	
		32	3000	1840	3080	>80	1420	MO123D	01 27	
		38,4	3000	2208	3696	>80	1700	MO124	01 27	
		38,4	3000	2208	3696	>80	1700	MO124D	01 27	
	50000h Ta 25° L70B10									
	A+									

Su richiesta disponibile la versione 4000°K | On request available version 4000°K | Versión con 4000K a demanda

Dali : Versione dimmerabile Dali. Adattatore compatibile con binari One Track (A.A.G. Stucchi ) o Global Track pulse (Nordic Aluminium)/ Dimmable Dali version. For connection to the One Track (A.A.G. Stucchi ) or Global Track pulse (Nordic Aluminium)/ Versione dimmable Dali. Se puede usar en el binario One Track (A.A.G. Stucchi ) or Global Track pulse (Nordic Aluminium).

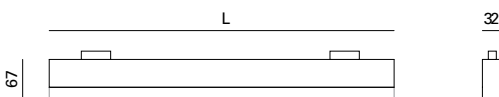

01 - bianco - white - blanco 27 - ossidato alluminio - oxidised aluminium - oxidado aluminio

## PROFILO VUOTO SEMI INCASSO/SOFFITTO/SOSPENSIONE

CEILING/SEMI-RECESSED/SUSPENSION EMPTY PROFILE - PERFIL VACIO TECHO/SEMIEMPOTRABLE/SUSPENSIÓN



led module	L.mm	CODE
led 12,8W	566	MO000.566 01 27
seamless 14/24WW	589	MO000.589 01 27
led 19,2W	846	MO000.846 01 27
seamless 21/39W	889	MO000.889 01 27
led 25,6W	1126	MO000.1126 01 27
seamless 28/54W	1189	MO000.1189 01 27
led 32W	1406	MO000.1406 01 27
led 38,4W	1686	MO000.1686 01 27
seamless 1+1 21/39W	1774	MO000.1774 01 27
seamless 1+1 28/54W	2374	MO000.2374 01 27
led/seamless	3000	MO000.3000 01 27
	.....	MO000.misura* 01 27

\*TRAMITE QUESTO CODICE È POSSIBILE ORDINARE IL PROFILO IN UNA LUNGHEZZA LINEARE NON STANDARD. SOSTITUIRE A " \_ \_ \_ " LA LUNGHEZZA DESIDERATA IN MM. PER ORDINARE UN PROFILO CON UNA O ENTRAMBE LE ESTREMITÀ TAGLIATE AD ANGOLO 45° AGGIUNGERE ALLA MISURA LA LETTERA "D" (TAGLIO DESTRO) O "S" (TAGLIO SINISTRO). SEGUIRE ISTRUZIONI RIPORTATE A PAG. 834. PER PROFILI OLTRE I 3 MT E MASSIMO 6 MT LE CONDIZIONI DI TRASPORTO SONO DA CONCORDARE. | \*THROUGH THIS CODE IT'S POSSIBLE TO ORDER THE PROFILE IN A NOT-STANDARD LINEAR LENGHT. REPLACE THE WORD "MISURA" WITH THE DESIRED LENGHT IN MM. TO ORDER A PROFILE WITH ONE OR BOTH ENDS 45° ANGLE-CUT ADD THE LETTER "D" (RIGHT CUT) OR "S" (LEFT CUT) TO THE STANDARD OR CUSTOM LENGHT . FOLLOW THE INSTRUCTIONS ON PAGE 834. FOR LENGHTS OVER 3 MT. TO MAX. 6 MT. TRANSPORT CONDITIONS TO NEGOTIATE. | \*EL USO DE ESTE CÓDIGO, SE PUEDE ORDENAR EL PERFIL EN UN LINEAL LONGITUD NO ESTÁNDAR. SUSTITÚYASE LA PALABRA "MEDIDA" DE LA LONGITUD EN MM. PARA PEDIR UN PERFIL CON UNO O AMBOS EXTREMOS CORTADOS EN UN ÁNGULO DE 45 ° A AÑADIR A LA MEDIDA DE LA LETRA "D" (DERECHA CORTADA) O "S" (IZQUIERDA CORTADA). SIGA LAS INSTRUCCIONES DE LA PÁGINA. 834. PARA PERFILES DE MAS DE 3 METROS Y MAXIMO 6 METROS DE LONGITUD LAS CONDICIONES DE TRANSPORTES SON A ACORDAR.

## COPPIA TESTATE SOFFITTO/SEMI INCASSO/SOSPENSIONE

COUPLE OF CLOSURE HEADS CEILING/SEMI-RECESSED/SUSPENSION VERSION- PAREJA DE TAPAS FINALES TECHO/SEMI-EMPOTRABLE/SUSPENSION



CODE	Col.
MO005	01 27

## DIFFUSORE

DIFFUSER- DIFUSOR



led module	L.mm	CODE
led 12,8W	565	MO004.1133
seamless 14/24WW	588	MO004.1186
led 19,2W	845	MO004.1413
seamless 21/39W	888	MO004.1693
led 25,6W	1125	MO004.1771
seamless 28/54W	1188	MO004.2371
led 32W	1405	MO004.3000
led 38,4W	1685	MO004.573
seamless 1+1 21/39W	1773	MO004.586
seamless 1+1 28/54W	2373	MO004.853
led/seamless	2999	MO004.886
	.....	MO004.misura

01 - bianco - white - blanco 27 - ossidato alluminio - oxidised aluminium - oxidado aluminio

## STAFFA SINGOLA SEMI INCASSO

SINGLE FIXING BRACKET FOR SEMI-RECESSED VERSION. - SOPORTE INDIVIDUAL SEMIEMPOTRABLE



UNA OGNI METRO, MINIMO 2 / ONE EVERY METER, 2 PIECES MINIMUM / UNO CADA METRO, MÍNIMO 2

CODE  
MO007

## COPPIA GIUNTI LINEARI

LINEAR JOINTS COUPLE - PAREJA DE CONECTORES LINEALES



CODE  
LTM211

## COPPIA GIUNTI ANGOLARI PARETE / SOFFITTO

ANGLE CONNECTOR COUPLE- PAREJA DE CONECTORES ANGULO



CODE  
LTM211.90P

## COPPIA GIUNTI ANGOLARI 90°

90°ANGLE CONNECTOR COUPLE- PAREJA DE CONECTORES ANGULO 90°



CODE  
LTM211.90

## KIT CAVI DI SOSPENSIONE IN ACCIAIO L.2000

STEEL SUSPENSION KIT- KIT DE SUSPENSION IN ACERO



Uno ogni 1,5 mt. minimo 2 - One every 1,5 mt, 2 pieces minimum - Uno cada 1,5 mt, mínimo de 2 piezas.

L.mm  
2000

CODE  
LTM047

## KIT ALIMENTAZIONE PER SOSPENSIONE COMPLETO DI ROSONE

POWER CABLE KIT WITH CEILING CANOPY- KIT ALIMENTACION CON FLORON

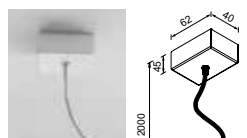

Dim.	L.mm
3X0,75	2000
4X0,75	2000
5X0,75	2000
7X0,75	2000

CODE	Col.
LTM048.3	01
LTM048.4	01
LTM048.5	01
LTM048.7	01

## MINIFILE OPENLIGHT REGLETTE LED 24W/MT

24W/MT LED BATTEN- REGLETTE LED 24W/MT

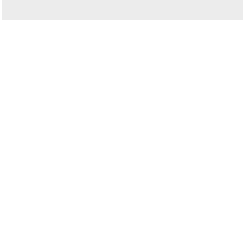
	W	K	lm product	lm/Led	CRI	DaliT&D	L:mm	CODE	
 <p>LINEAR LED 24W/MT 2200LM/MT CRI&gt;80</p> <p>50000h Ta 25° L70B10 <b>A+</b></p>	12,8	3000	736	1232	>80		560	<b>RLM3M01</b>	
	12,8	3000	736	1232	>80	X	560	<b>RLM3M01D</b>	
	19,2	3000	1104	1848	>80		840	<b>RLM3M02</b>	
	19,2	3000	1104	1848	>80	X	840	<b>RLM3M02D</b>	
	25,6	3000	1472	2464	>80		1120	<b>RLM3M03</b>	
	25,6	3000	1472	2464	>80	X	1120	<b>RLM3M03D</b>	
	32	3000	1840	3080	>80		1400	<b>RLM3M04</b>	
	32	3000	1840	3080	>80	X	1400	<b>RLM3M04D</b>	
	38,4	3000	2208	3696	>80		1680	<b>RLM3M05</b>	
	38,4	3000	2208	3696	>80	X	1680	<b>RLM3M05D</b>	
	51,2	3000	2944	4928	>80		2240	<b>RLM3M07</b>	
	51,2	3000	2944	4928	>80	X	2240	<b>RLM3M07D</b>	
	alimentatore incluso   included ballast   con trasformador								
	 <p>LINEAR LED 24W/MT 2285LM/MT CRI&gt;80</p> <p>50000h Ta 25° L70B10 <b>A+</b></p>	12,8	4000	1135	1900	>80		560	<b>RLM4M01</b>
12,8		4000	1135	1900	>80	X	560	<b>RLM4M01D</b>	
19,2		4000	1703	2850	>80		840	<b>RLM4M02</b>	
19,2		4000	1703	2850	>80	X	840	<b>RLM4M02D</b>	
25,6		4000	2271	3800	>80		1120	<b>RLM4M03</b>	
25,6		4000	2271	3800	>80	X	1120	<b>RLM4M03D</b>	
32		4000	2838	4750	>80		1400	<b>RLM4M04</b>	
32		4000	2838	4750	>80	X	1400	<b>RLM4M04D</b>	
38,4		4000	3406	5700	>80		1680	<b>RLM4M05</b>	
38,4		4000	3406	5700	>80	X	1680	<b>RLM4M05D</b>	
51,2		4000	4541	7600	>80		2240	<b>RLM4M07</b>	
51,2		4000	4541	7600	>80	X	2240	<b>RLM4M07D</b>	
alimentatore incluso   included ballast   con trasformador									

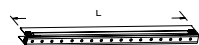

## REGLETTE FLUO SEAMLESS

SEAMLESS FLUO BATTEN- REGLETTE FLUO SEAMLESS

	W	DaliT&D	L:mm	CODE
 <p>T16 SEAMLESS</p> <p><b>A++A</b></p>	14-24		585	<b>LTM034</b>
	14-24	X	585	<b>LTM034D</b>
	21-39		885	<b>LTM035</b>
	21-39	X	885	<b>LTM035D</b>
	28-54		1185	<b>LTM036</b>
	28-54	X	1185	<b>LTM036D</b>
	1+1x21-39		1770	<b>LTMB34</b>
	1+1x21-39	X	1770	<b>LTMB34D</b>
	1+1x28-54		2370	<b>LTMB35</b>
	1+1x28-54	X	2370	<b>LTMB35D</b>
	alimentatore incluso   included ballast   con trasformador			





## MINIFILE OPENLIGHT STRIP BOBINA DA 5 METRI

STRIP LED 5 METERS ROLL- BOBINA STRIP LED 5 METROS



	W/mt	V	Led/ mt	lm/mt	K	lm product	lm/W	CRI	IP	A	Lmm	Kg	CODE
LINEAR LED 24V <b>A+</b>	5,5	24	60	270	3000	1350	245	80	20	V.1	5000	0,18	ST05.30.5
	9,6	24	120	540	3000	2700	281	80	20	V.1	5000	0,18	ST10.30.5
	11	24	180	1200	3000	6000	545	80	20	V.1	5000	0,18	ST11.30.5
	18	24	168	2200	3000	11000	611	80	20	V.1	5000	0,18	ST21.30.5
LINEAR LED IP65 24V <b>A+</b>	9,6	24	120	540	3000	2700	281	80	65	V.1	5000	0,18	ST10.30.5IP
	14,4	24	60	900	3000	4500	313	80	65	V.1	5000	0,18	ST15.30.5IP
	19,2	24	240	1080	3000	5400	281	80	65	V.1	5000	0,18	ST20.30.5IP

## MINIFILE OPENLIGHT DISSIPATORE PER STRIP LED

HEATSINK FOR STRIPLED- DISIPADOR PARA STRIP LED



	Lmm	CODE
	1000	LTMC.1000
	2000	LTMC.2000
	3000	LTMC.3000
	.....	LTMC.misura

---

Serie di apparecchi da incasso, incasso a scomparsa totale, a soffitto, parete e a sospensione per illuminazione diretta diffusa, per sorgenti lineari LED o lampade fluorescenti T16. Alimentazione elettronica integrata 230/240V-50/60Hz. Corpo in estruso di alluminio 61,5x40mm. Finitura verniciata o anodizzata. Cornice di battuta super-slim larghezza 5 mm. Completi di staffe di fissaggio al controsoffitto con sistema di regolazione a vite e testate di chiusura laterali e schermo diffondente in policarbonato opalino bianco o microprismatico a luminanza controllata (conforme normativa EN12464-1) o griglia dark-light in alluminio ad alta specularità. Grado di protezione IP40/IP43. Cassaforma in estruso di alluminio per incasso in laterizio o calcestruzzo disponibile come accessorio.

Series of recessed and trimless recessed, ceiling-mounted, wall-mounted and hanging fixtures for direct diffused lighting. For integrated linear LED sources or for T16 fluorescent lamps. 230/240V-50/60Hz integrated electronic supply. Body in 61,5x40 mm. extruded aluminium. Painted or anodized finish. Super-slim 5 mm. width edge trim. Complete with false-ceiling/wall fixing brackets, provided with micro-regulation screw system, side end caps and opal white or microprismatic (conform to EN 12464-1 EU directive) polycarbonate diffuser or high efficiency dark-light aluminium grid. The fixtures become system modules if installed within the Container profile (see Systems section). Protection degree IP40/IP43. Extruded aluminium wallbox for recessed installation in concrete or brick walls, available as an accessory.

Serie de aparatos empotrados, total empotrados, pared, techo y suspension para iluminación directa difuminada, para LED, fluorescentes T16. Alimentación electrónica integrada 50/60Hz 230V/240V. Cuerpo en estruso de aluminio 61,5x40mm. Acabado barnizado o anodizado. Marco "super-slim" de sólo 5mm. Con soporte de fijación al falso techo con sistema de regulación mediante tornillo y tapas de cierre laterales y difusor en policarbonato opal blanco o microprismático (conforme normativa EN12464-1) o dark light en aluminio de alta luminosidad. Grado de protección IP40/IP43. Caja en estruso de aluminio para la instalación en ladrillo u hormigón disponible como accesorio.

---

**FILE**





CASCIOLI CONCESSIONARIA **BMW** SAN BENEDETTO DEL TRONTO - ITALY  
PHOTO ER STUDIO







OS CLUB ROMA - ITALY  
PROJECT BY ARCH. M. M. GENTILE  
PHOTO G. COMESE



## SEZIONI PROFILO FILE

### INCASSO - RECESSED - EMPOTRADO

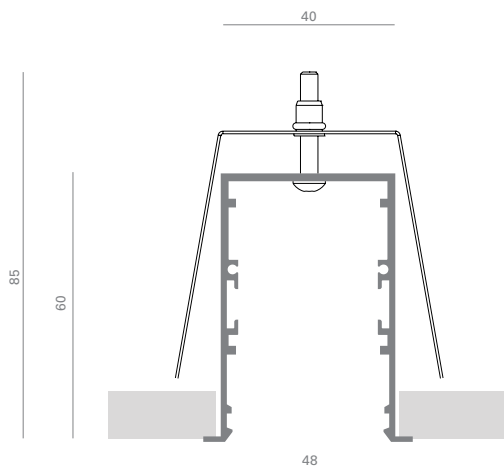

diffusore in policarbonato opalino  
opaline polycarbonate diffuser  
difusor en policarbonato opalino



diffusore microprismatico a luminanza controllata  
(conforme alla normativa EN 12464-1)  
microprismatic diffuser  
difusor microprismatico



riflettore darklight  
darklight grid  
reflector darklight

### INCASSO RASATO - TRIMLESS RECESSED - TOTAL EMPOTRADO

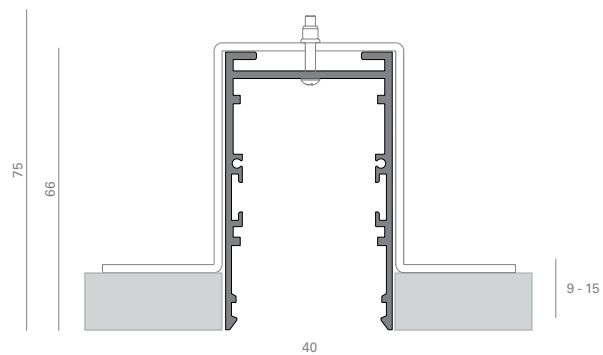

diffusore in policarbonato opalino  
opaline polycarbonate diffuser  
difusor en policarbonato opalino



**SOFFITTO  
SOSPENSIONE  
PARETE**

**CEILING  
SUSPENSION  
WALL**

**TECHO  
SUSPENSIÓN  
PARED**

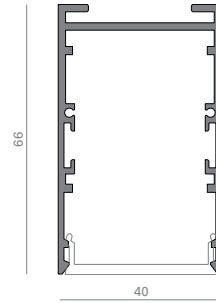

diffusore in polcarbonato opalino  
opaline polycarbonate diffuser  
difusor en polcarbonato opalino



diffusore microprismatico a luminanza controllata  
(conforme normativa EN 12464-1)  
microprismatic diffuser  
difusor microprismatico

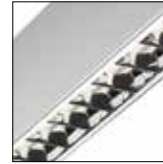

riflettore darklight  
darklight grid  
reflector darklight

# FILE INCASSO CON DIFFUSORE OPALINO

RECESSED WITH DIFFUSER - EMPOTRADO CON DIFUSOR

42xL+2



	W	K	Im product	Im/Led	CRI	DaliT&D	Lmm	Kg	CODE	Col.
LINEAR LED 24W/MT 2200LM/MT CRI>80	12,8	3000	736	1232	>80		580	0.95	LTC030	01 02 27
	12,8	3000	736	1232	>80	x	580	1.15	LTC030D	01 02 27
	19,2	3000	1104	1848	>80		860	1.30	LTC031	01 02 27
	19,2	3000	1104	1848	>80	x	860	1.50	LTC031D	01 02 27
	25,6	3000	1472	2464	>80		1140	1.70	LTC032	01 02 27
	25,6	3000	1472	2464	>80	x	1140	1.90	LTC032D	01 02 27
	32	3000	1840	3080	>80		1420	2.10	LTC033	01 02 27
	32	3000	1840	3080	>80	x	1420	2.25	LTC033D	01 02 27
	38,4	3000	2208	3696	>80		1700	2.60	LTC034	01 02 27
	38,4	3000	2208	3696	>80	x	1700	2.80	LTC034D	01 02 27
	44,8	3000	2576	4312	>80		1985	3.25	LTC035	01 02 27
	44,8	3000	2576	4312	>80	x	1985	3.35	LTC035D	01 02 27
	51,2	3000	2944	4928	>80		2265	3.45	LTC036	01 02 27
	51,2	3000	2944	4928	>80	x	2265	3.60	LTC036D	01 02 27
	57,6	3000	3313	5544	>80		2545	3.65	LTC037	01 02 27
	57,6	3000	3313	5544	>80	x	2545	3.80	LTC037D	01 02 27
	64	3000	3681	6160	>80		2825	4.10	LTC038	01 02 27
	64	3000	3681	6160	>80	x	2825	4.25	LTC038D	01 02 27

50000h Ta 25°  
L70B10 **A+**

CE  
IP43  
A

Su richiesta disponibile la versione 4000K | On request available 4000K version | Versión con 4000K a demanda.

	W	Lmm	Kg	CODE	Col.
T16	14-24	575	0.85	LT3030	01 02 27
	21-39	875	1.40	LT3032	01 02 27
	28-54	1175	1.60	LT3034	01 02 27
	35-49-80	1475	1.97	LT3036	01 02 27
	1+1x21-39	1747	2.75	LTA038	01 02 27
	1+1x28-54	2347	3.60	LT3039	01 02 27
	1+1x35-49	2947	4.40	LTA040	01 02 27
	1+1x80	2947	4.40	LTA041	01 02 27

**A+**

CE  
IP43  
A

Su richiesta versione Emergenza | Emergency version on request | Versiones de emergencia a demanda

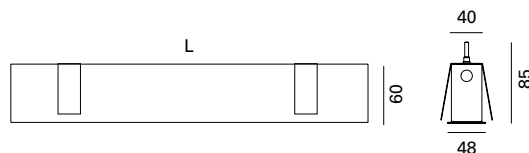
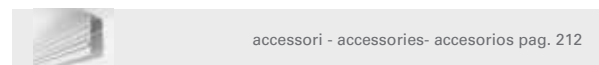

# FILE INCASSO CON DIFFUSORE MICROPRISMATICO\*

42xL+2

RECESSED WITH MICROPRISMATIC DIFFUSER- EMPOTRADO CON DIFUSOR MICROPRISMATICO



	W	K	Im product	Im/Led	CRI	DaliT&D	Lmm	Kg	CODE	Col.
LINEAR LED 24W/MT 2200LM/MT CRI>80	12,8	3000	864	1232	>80		580	0.95	LTC030X	01 02 27
	12,8	3000	864	1232	>80	x	580	1.15	LTC030XD	01 02 27
	19,2	3000	1296	1848	>80		860	1.30	LTC031X	01 02 27
	19,2	3000	1296	1848	>80	x	860	1.50	LTC031XD	01 02 27
	25,6	3000	1728	2464	>80		1140	1.70	LTC032X	01 02 27
	25,6	3000	1728	2464	>80	x	1140	1.90	LTC032XD	01 02 27
	32	3000	2160	3080	>80		1420	2.10	LTC033X	01 02 27
	32	3000	2160	3080	>80	x	1420	2.25	LTC033XD	01 02 27
	38,4	3000	2592	3696	>80		1700	2.60	LTC034X	01 02 27
	38,4	3000	2592	3696	>80	x	1700	2.80	LTC034XD	01 02 27
	44,8	3000	3024	4312	>80		1985	3.25	LTC035X	01 02 27
	44,8	3000	3024	4312	>80	x	1985	3.35	LTC035XD	01 02 27
	51,2	3000	3456	4928	>80		2265	3.45	LTC036X	01 02 27
	51,2	3000	3456	4928	>80	x	2265	3.60	LTC036XD	01 02 27
	57,6	3000	3888	5544	>80		2545	3.65	LTC037X	01 02 27
	57,6	3000	3888	5544	>80	x	2545	3.80	LTC037XD	01 02 27
	64	3000	4320	6160	>80		2825	4.10	LTC038X	01 02 27
	64	3000	4320	6160	>80	x	2825	4.25	LTC038XD	01 02 27

50000h Ta 25°  
L70B10

A+

CE  
IP43  
IP43  
A

PER LA VERSIONE 4000K VEDI CODICI .4 A LISTINO | FOR 4000K VERSION SEE CODE .4 ON PRICELIST | POR LA VERSIÓN 4000K VER CODIGO .4 EN LA LISTA DE PRECIOS.

	W	Lmm	Kg	CODE	Col.
T16	14-24	575	0.85	LT3030X	01 02 27
	21-39	875	1.40	LT3032X	01 02 27
	28-54	1175	1.60	LT3034X	01 02 27
	35-49-80	1475	1.97	LT3036X	01 02 27
	1+1x21-39	1747	2.75	LTA038X	01 02 27
	1+1x28-54	2347	3.60	LT3039X	01 02 27
	1+1x35-49	2947	4.40	LTA040X	01 02 27
	1+1x80	2947	4.40	LTA041X	01 02 27

A++A

CE  
IP43  
IP43  
A

Su richiesta versione Emergenza | Emergency version on request | Versión de emergencia a demanda

\* DIFFUSORE MICROPRISMATICO A LUMINANZA CONTROLLATA (CONFORME NORMATIVA EN 12464-1) - CONTROLLED LUMINANCE MICROPRISMATIC DIFFUSER (CONFORMS TO STANDARD EN 12464-1) - DIFUSOR MICROPRISMATICO A LUMINANCIA CONTROLADA (SEGÚN EN 12464-1)

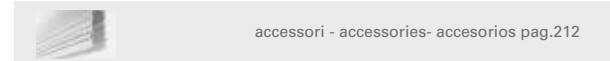
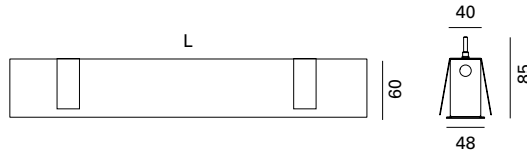

01 - bianco - white - blanco 02 - nero - black - negro 27 - ossidato alluminio - oxidised aluminium - oxidado aluminio

pag.824

# FILE INCASSO CON DARKLIGHT\*

FLUO FILE RECESSED WITH DARKLIGHT- FLUO CON DARKLIGHT

42XL+2



T16	W
	14-24
	21-39
	28-54
	35-49-80
	1+1x21-39
	1+1x28-54
	1+1x35-49
	1+1x80

Lmm	Kg	CODE	Col.
575	0.85	LT3030K	01 02 27
875	1.40	LT3032K	01 02 27
1175	1.60	LT3034K	01 02 27
1475	1.97	LT3036K	01 02 27
1747	2.50	LTA038K	01 02 27
2347	3.60	LT3039K	01 02 27
2947	4.40	LTA040K	01 02 27
2947	4.40	LTA041K	01 02 27



Su richiesta versioni Emergenza | Emergency version on request | Versiones de emergencia a demanda

\* RIFLETTORE A LUMINANZA CONTROLLATA (CONFORME NORMATIVA EN 12464-1) - CONTROLLED LUMINANCE REFLECTOR (CONFORMS TO STANDARD EN 12464-1) - REFLECTORE A LUMINANCIA CONTROLADA (SEGÚN EN 12464-1)

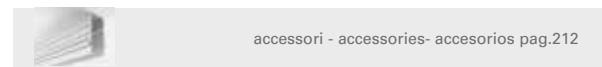
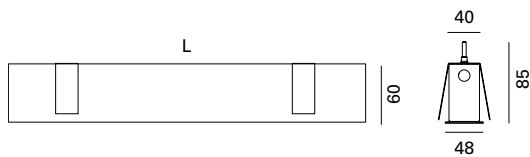

01 - bianco - white - blanco 02 - nero - black - negro 27 - ossidato alluminio - oxidised aluminium - oxidado aluminio



ENTERTAINMENT ROOM  
PHOTO ER STUDIO



BOUTIQUE AL CARMINE MILAZZO - ITALY  
PHOTO L.PERDEGHIZZI





# FILE INCASSO RASATO CON DIFFUSORE OPALINO

42XL+2

TRIMLESS RECESSED WITH DIFFUSER- TOTAL EMPOTRABLE CON DIFUSOR



W	K	lm product	lm/Led	CRI	DalIT&D	Lmm	Kg	CODE	Col.
12,8	3000	736	1232	>80		580	0,85	LTC044	01
12,8	3000	736	1232	>80	x	580	0,85	LTC044D	01
19,2	3000	1104	1848	>80		860	1,38	LTC045	01
19,2	3000	1104	1848	>80	x	860	1,38	LTC045D	01
25,6	3000	1472	2464	>80		1140	1,50	LTC046	01
25,6	3000	1472	2464	>80	x	1140	1,50	LTC046D	01
32	3000	1840	3080	>80		1420	1,80	LTC047	01
32	3000	1840	3080	>80	x	1420	1,80	LTC047D	01
38,4	3000	2208	3696	>80		1700	2,00	LTC048	01
38,4	3000	2208	3696	>80	x	1700	2,00	LTC048D	01
44,8	3000	2576	4312	>80		1985	2,70	LTC049	01
44,8	3000	2576	4312	>80	x	1985	2,70	LTC049D	01
51,2	3000	2944	4928	>80		2265	3,00	LTC050	01
51,2	3000	2944	4928	>80	x	2265	3,00	LTC050D	01
57,6	3000	3313	5544	>80		2545	3,80	LTC051	01
57,6	3000	3313	5544	>80	x	2545	3,80	LTC051D	01
64	3000	3681	6160	>80		2825	4,00	LTC052	01
64	3000	3681	6160	>80	x	2825	4,00	LTC052D	01

Su richiesta disponibile la versione 4000°K | On request available version 4000°K | Versión con 4000°K demanda

T16	W	Lmm	Kg	CODE	Col.
	14-24	577	0,85	LT3044	01
	21-39	877	1,40	LT3046	01
	28-54	1177	1,60	LT3048	01
	35-49-80	1477	1,97	LT3050	01
	1+1x21-39	1749	2,50	LTA052	01
	1+1x28-54	2349	3,60	LT3053	01
	1+1x35-49	2949	4,40	LTA054	01
	1+1x80	2949	4,40	LTA055	01

Su richiesta versioni Emergenza | Emergency versions on request | Versiones de emergencia



accessori - accessories - accesorios pag.212

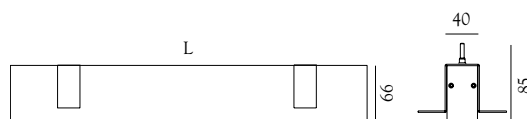



# FILE INCASSO RASATO CON DIFFUSORE MICROPRISMATICO\*

42XL+2

TRIMLESS RECESSED WITH MICROPRISMATIC DIFFUSER - TOTAL EMPOTRABLE CON DIFUSOR MICROPRISMATICO



	W	K	lm product	lm/Led	CRI	DalIT&D	Lmm	Kg	CODE	Col.
LINEAR LED 24W/MT 2200lm/MT CRI>80	12,8	3000	864	1232	>80		580	0,85	LTC044X	01
	12,8	3000	864	1232	>80	x	580	0,85	LTC044XD	01
	19,2	3000	1296	1848	>80		860	1,38	LTC045X	01
	19,2	3000	1296	1848	>80	x	860	1,38	LTC045XD	01
	25,6	3000	1728	2464	>80		1140	1,50	LTC046X	01
	25,6	3000	1728	2464	>80	x	1140	1,50	LTC046XD	01
	32	3000	2160	3080	>80		1420	1,80	LTC047X	01
	32	3000	2160	3080	>80	x	1420	1,80	LTC047XD	01
	38,4	3000	2592	3696	>80		1700	2,00	LTC048X	01
	38,4	3000	2592	3696	>80	x	1700	2,00	LTC048XD	01
	44,8	3000	3024	4312	>80		1985	2,70	LTC049X	01
	44,8	3000	3024	4312	>80	x	1985	2,70	LTC049XD	01
	51,2	3000	3456	4928	>80		2265	3,00	LTC050X	01
	51,2	3000	3456	4928	>80	x	2265	3,00	LTC050XD	01
	57,6	3000	3888	5544	>80		2545	3,80	LTC051X	01
	57,6	3000	3888	5544	>80	x	2545	3,80	LTC051XD	01
	64	3000	4320	6160	>80		2825	4,00	LTC052X	01
64	3000	4320	6160	>80	x	2825	4,00	LTC052XD	01	

50000h Ta 25°  
L70B10



PER LA VERSIONE 4000K VEDI CODICI .4 A LISTINO | FOR 4000K VERSION SEE CODE .4 ON PRICELIST | POR LA VERSIÓN 4000K VER CODIGO .4 EN LA LISTA DE PRECIOS.

	W	Lmm	Kg	CODE	Col.
T16	14-24	577	0,85	LT3044X	01
	21-39	877	1,40	LT3046X	01
	28-54	1177	1,60	LT3048X	01
	35-49-80	1477	1,97	LT3050X	01
	1+1x21-39	1749	2,50	LTA052X	01
	1+1x28-54	2349	3,60	LT3053X	01
	1+1x35-49	2949	4,40	LTA054X	01
	1+1x80	2949	4,40	LTA055X	01

A++



Su richiesta versioni Emergenza | Emergency versions on request | Versiones de emergencia

\* DIFFUSORE MICROPRISMATICO A LUMINANZA CONTROLLATA (CONFORME NORMATIVA EN 12464-1) - CONTROLLED LUMINANCE MICROPRISMATIC DIFFUSER (CONFORMS TO STANDARD EN 12464-1) - DIFUSOR MICROPRISMATICO A LUMINANCIA CONTROLADA (SEGÚN EN 12464-1)



accessori - accessories - accesorios pag.212

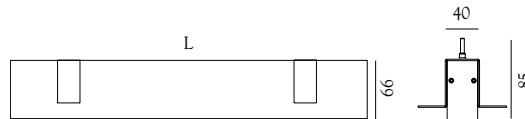



TABAKALERA - CENTRO INTERNACIONAL DE CULTURA CONTEMPORÀNEA - SPAIN  
LIGHTING PROJECT TAO ILLUMINACION





RISTORANTE OS CLUB ROMA - ITALY  
PHOTO ER STUDIO

# FILE SOFFITTO CON DIFFUSORE OPALINO

CEILING WITH DIFFUSER- TECHO CON DIFUSOR



LINEAR LED 24W/MT 2200LM/MT CRI>80	W	K	lm product	lm/Led	CRI	DalIT&D	Lmm	Kg	CODE	Col.
	12,8	3000	736	1232	>80		580	1,15	LTC830	01 02 27 49
	12,8	3000	736	1232	>80	x	580	1,15	LTC830D	01 02 27 49
	19,2	3000	1104	1848	>80		860	1,68	LTC831	01 02 27 49
	19,2	3000	1104	1848	>80	x	860	1,68	LTC831D	01 02 27 49
	25,6	3000	1472	2464	>80		1140	1,80	LTC832	01 02 27 49
	25,6	3000	1472	2464	>80	x	1140	1,80	LTC832D	01 02 27 49
	32	3000	1840	3080	>80		1420	2,10	LTC833	01 02 27 49
	32	3000	1840	3080	>80	x	1420	2,10	LTC833D	01 02 27 49
	38,4	3000	2208	3696	>80		1700	2,30	LTC834	01 02 27 49
	38,4	3000	2208	3696	>80	x	1700	2,30	LTC834D	01 02 27 49
	44,8	3000	2576	4312	>80		1985	3,00	LTC835	01 02 27 49
	44,8	3000	2576	4312	>80	x	1985	3,00	LTC835D	01 02 27 49
	51,2	3000	2944	4928	>80		2265	3,30	LTC836	01 02 27 49
	51,2	3000	2944	4928	>80	x	2265	3,30	LTC836D	01 02 27 49
	57,6	3000	3313	5544	>80		2545	4,10	LTC837	01 02 27 49
	57,6	3000	3313	5544	>80	x	2545	4,10	LTC837D	01 02 27 49
	64	3000	3681	6160	>80		2825	4,30	LTC838	01 02 27 49
	64	3000	3681	6160	>80	x	2825	4,30	LTC838D	01 02 27 49

50000h Ta 25°  
L70B10 **A+**

CE IP40  
A

Su richiesta disponibile la versione 4000°K | On request available version 4000°K | Versión con 4000°K demanda

T16	W	Lmm	Kg	CODE	Col.
	14-24	581	1,08	LT2830	01 02 27 49
	21-39	881	1,40	LT2832	01 02 27 49
	28-54	1181	1,95	LT2834	01 02 27 49
	35-49-80	1481	2,35	LT2836	01 02 27 49
	1+1x21-39	1753	2,80	LTA837	01 02 27 49
	1+1x28-54	2353	3,50	LT2839	01 02 27 49
	1+1x35-49	2953	4,40	LTA840	01 02 27 49
	1+1x80	2953	4,40	LTA841	01 02 27 49

**A++A**

CE IP40  
A

Su richiesta versione Emergenza | Emergency version on request | Emergencia versione a demanda

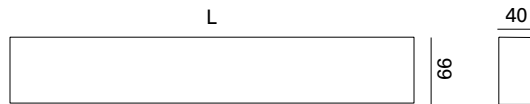

## FILE SOFFITTO CON DIFFUSORE MICROPRISMATICO\*

CEILING WITH MICROPRISMATIC DIFFUSER- TECHO CON DIFUSOR MICROPRISMATICO



	W	K	lm product	lm/Led	CRI	DalIT&D	Lmm	CODE	Col.	
LINEAR LED 24W/MT 2200LM/MT CRI>80	12,8	3000	864	1232	>80		580	LTC830X	01 02 27 49	
	12,8	3000	864	1232	>80	x	580	LTC830XD	01 02 27 49	
	19,2	3000	1296	1848	>80		860	LTC831X	01 02 27 49	
	19,2	3000	1296	1848	>80	x	860	LTC831XD	01 02 27 49	
	25,6	3000	1728	2464	>80		1140	LTC832X	01 02 27 49	
	25,6	3000	1728	2464	>80	x	1140	LTC832XD	01 02 27 49	
	32	3000	2160	3080	>80		1420	LTC833X	01 02 27 49	
	32	3000	2160	3080	>80	x	1420	LTC833XD	01 02 27 49	
	38,4	3000	2592	3696	>80		1700	LTC834X	01 02 27 49	
	38,4	3000	2592	3696	>80	x	1700	LTC834XD	01 02 27 49	
	44,8	3000	3024	4312	>80		1985	LTC835X	01 02 27 49	
	44,8	3000	3024	4312	>80	x	1985	LTC835XD	01 02 27 49	
	51,2	3000	3456	4928	>80		2265	LTC836X	01 02 27 49	
	51,2	3000	3456	4928	>80	x	2265	LTC836XD	01 02 27 49	
	57,6	3000	3888	5544	>80		2545	LTC837X	01 02 27 49	
	57,6	3000	3888	5544	>80	x	2545	LTC837XD	01 02 27 49	
	64	3000	4320	6160	>80		2825	LTC838X	01 02 27 49	
	64	3000	4320	6160	>80	x	2825	LTC838XD	01 02 27 49	

PER LA VERSIONE 4000K VEDI CODICI .4 A LISTINO | FOR 4000K VERSION SEE CODE .4 ON PRICELIST | POR LA VERSIÓN 4000K VER CODIGO .4 EN LA LISTA DE PRECIOS.

	W	Lmm	Kg	CODE	Col.	
T16	14-24	581	1.08	LT2830X	01 02 27 49	
	21-39	881	1.40	LT2832X	01 02 27 49	
	28-54	1181	1.95	LT2834X	01 02 27 49	
	35-49-80	1481	2.35	LT2836X	01 02 27 49	
	1+1x21-39	1753	2.80	LTA837X	01 02 27 49	
	1+1x28-54	2353	3.50	LT2839X	01 02 27 49	
	1+1x35-49	2953	4.40	LTA840X	01 02 27 49	
	1+1x80	2953	4.40	LTA841X	01 02 27 49	

Su richiesta versione Emergenza | Emergency version on request | Emergencia versione a demanda

\* DIFFUSORE MICROPRISMATICO A LUMINANZA CONTROLLATA (CONFORME NORMATIVA EN 12464-1) - CONTROLLED LUMINANCE MICROPRISMATIC DIFFUSER (CONFORMS TO STANDARD EN 12464-1) - DIFUSOR MICROPRISMATICO A LUMINANCIA CONTROLADA (SEGÚN EN 12464-1)

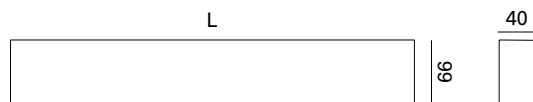

## FILE SOFFITTO CON DARKLIGHT\*

CEILING WITH DARKLIGHT- TECHO CON DARKLIGHT



T16	W	Lmm	Kg	CODE	Col.
	14-24	581	1.08	LT2830K	01 02 27 49
	21-39	881	1.40	LT2832K	01 02 27 49
	28-54	1181	1.95	LT2834K	01 02 27 49
	35-49-80	1481	2.35	LT2836K	01 02 27 49
	1+1x21-39	1753	2.80	LTA837K	01 02 27 49
	1+1x28-54	2353	3.50	LT2839K	01 02 27 49
	1+1x35-49	2953	4.40	LTA840K	01 02 27 49
	1+1x80	2953	4.40	LTA841K	01 02 27 49

Su richiesta versione Emergenza | Emergency version on request | Emergencia versione a demanda

\*RIFLETTORE A LUMINANZA CONTROLLATA (CONFORME NORMATIVA EN 12464-1) - CONTROLLED LUMINANCE REFLECTOR (CONFORMS TO STANDARD EN 12464-1) - REFLECTORE A LUMINANCIA CONTROLADA (SEGUN EN 12464-1)

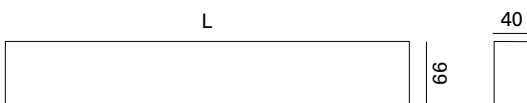

## CASSAFORMA

WALLBOX FILE- CAJA FILE



Dim.	H	Lmm	CODE	Col.
45 x 57	98	1000	LTF1.1000	27
45 x 57	98	2000	LTF1.2000	27
45 x 57	98	3000	LTF1.3000	27
45 x 57	98	.....	LTF1.misura	27

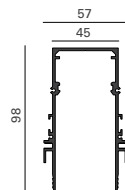

## FILE COPPIA DITESTATE CASSAFORMA

COUPLE OF CLOSURE HEADS FOR WALLBOX FILE- TAPAS FINAL POR ENCOFRADO FILE



CODE
LT2480.1

01 - bianco - white - bianco 
  02 - nero - black - negro 
  27 - ossidato alluminio - oxidised aluminium - oxidado aluminio 
  49 - moka - moka - moka



pag.824





PARQUET DIFFUSION IMOLA - ITALY  
PHOTO D.DOMENICALI



# FILE SOSPENSIONE CON DIFFUSORE OPALINO

SUSPENSION WITH DIFFUSER- SUSPENSION CON DIFUSOR



	W	K	lm product	lm/Led	CRI	DaliT&D	Lmm	Kg	CODE	Col.
LINEAR LED 24W/MT 2200LM/MT CRi>80	12,8	3000	736	1232	>80		580	1,45	LTC844	01 02 27 49
	12,8	3000	736	1232	>80	x	580	1,45	LTC844D	01 02 27 49
	19,2	3000	1104	1848	>80		860	1,75	LTC845	01 02 27 49
	19,2	3000	1104	1848	>80	x	860	1,75	LTC845D	01 02 27 49
	25,6	3000	1472	2464	>80		1140	2,00	LTC846	01 02 27 49
	25,6	3000	1472	2464	>80	x	1140	2,00	LTC846D	01 02 27 49
	32	3000	1840	3080	>80		1420	2,40	LTC847	01 02 27 49
	32	3000	1840	3080	>80	x	1420	2,40	LTC847D	01 02 27 49
	38,4	3000	2208	3696	>80		1700	2,80	LTC848	01 02 27 49
	38,4	3000	2208	3696	>80	x	1700	2,80	LTC848D	01 02 27 49
	44,8	3000	2576	4312	>80		1985	3,10	LTC849	01 02 27 49
	44,8	3000	2576	4312	>80	x	1985	3,10	LTC849D	01 02 27 49
	51,2	3000	2944	4928	>80		2265	3,80	LTC850	01 02 27 49
	51,2	3000	2944	4928	>80	x	2265	3,80	LTC850D	01 02 27 49
	57,6	3000	3313	5544	>80		2545	4,20	LTC851	01 02 27 49
	57,6	3000	3313	5544	>80	x	2545	4,20	LTC851D	01 02 27 49
	64	3000	3681	6160	>80		2825	4,60	LTC852	01 02 27 49
64	3000	3681	6160	>80	x	2825	4,60	LTC852D	01 02 27 49	
50000h Ta 25° L70B10										

Su richiesta disponibile la versione 4000°K | On request available version 4000°K | Versión con 4000°K demanda

	W	Lmm	Kg	CODE	Col.	
T16	14-24	581	1,45	LT2844	01 02 27 49	
	21-39	881	1,75	LT2846	01 02 27 49	
	28-54	1181	2,15	LT2848	01 02 27 49	
	35-49-80	1481	2,50	LT2850	01 02 27 49	
	35-49-80	1481	2,50	LT2850D	01 02 27 49	
	1+1x21-39	1753	3,00	LTA852	01 02 27 49	
	1+1x21-39	1753	3,00	LTA852D	01 02 27 49	
	1+1x28-54	2353	3,90	LT2853	01 02 27 49	
	1+1x28-54	2353	3,90	LT2853D	01 02 27 49	
	1+1x35-49	2953	4,70	LTA854	01 02 27 49	
	1+1x35-49	2953	4,70	LTA854D	01 02 27 49	
	1+1x80	2953	4,70	LTA855	01 02 27 49	
	1+1x80	2953	4,70	LTA855D	01 02 27 49	

Su richiesta versione Emergenza | Emergency version on request | Emergencia versione bajo demanda

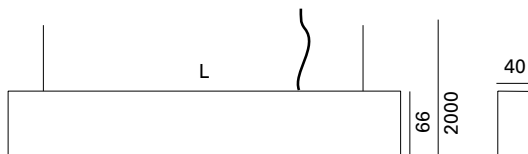

01 - bianco - white - bianco    02 - nero - black - negro    27 - ossidato alluminio - oxidised aluminium - oxidado aluminio    49 - moka - moka - moka

## FILE SOSPENSIONE CON DIFFUSORE MICROPRISMATICO\*

SUSPENSION WITH MICROPRISMATIC DIFFUSER- SUSPENSION CON DIFUSOR MICROPRISMATICO



	W	K	lm product	lm/Led	CRI	DalIT&D	Lmm	Kg	CODE	Col.	
LINEAR LED 24W/MT 2200LM/MT CRI>80	12,8	3000	864	1232	>80		580	0,90	LTC844X	01 02 27 49	
	12,8	3000	864	1232	>80	x	580	0,90	LTC844XD	01 02 27 49	
	19,2	3000	1296	1848	>80		860	1,60	LTC845X	01 02 27 49	
	19,2	3000	1296	1848	>80	x	860	1,60	LTC845XD	01 02 27 49	
	25,6	3000	1728	2464	>80		1140	2,10	LTC846X	01 02 27 49	
	25,6	3000	1728	2464	>80	x	1140	2,10	LTC846XD	01 02 27 49	
	32	3000	2160	3080	>80		1420	2,50	LTC847X	01 02 27 49	
	32	3000	2160	3080	>80	x	1420	2,50	LTC847XD	01 02 27 49	
	38,4	3000	2592	3696	>80		1700	2,90	LTC848X	01 02 27 49	
	38,4	3000	2592	3696	>80	x	1700	2,90	LTC848XD	01 02 27 49	
	44,8	3000	3024	4312	>80		1985	3,20	LTC849X	01 02 27 49	
	44,8	3000	3024	4312	>80	x	1985	3,20	LTC849XD	01 02 27 49	
	51,2	3000	3456	4928	>80		2265	3,50	LTC850X	01 02 27 49	
	51,2	3000	3456	4928	>80	x	2265	3,50	LTC850XD	01 02 27 49	
	57,6	3000	3888	5544	>80		2545	4,00	LTC851X	01 02 27 49	
	57,6	3000	3888	5544	>80	x	2545	4,00	LTC851XD	01 02 27 49	
	64	3000	4320	6160	>80		2825	4,50	LTC852X	01 02 27 49	
	64	3000	4320	6160	>80	x	2825	4,50	LTC852XD	01 02 27 49	

50000h Ta 25°  
L70B10

A+

PER LA VERSIONE 4000K VEDI CODICI .4 A LISTINO | FOR 4000K VERSION SEE CODE .4 ON PRICELIST | POR LA VERSIÓN 4000K VER CODIGO .4 EN LA LISTA DE PRECIOS.

	W	Lmm	Kg	CODE	Col.	
T16	14-24	581	1,15	LT2844X	01 02 27 49	
	21-39	881	1,45	LT2846X	01 02 27 49	
	28-54	1181	2,15	LT2848X	01 02 27 49	
	35-49-80	1481	2,50	LT2850X	01 02 27 49	
	35-49-80	1481	2,50	LT2850XD	01 02 27 49	
	21-39	1753	2,80	LTA852X	01 02 27 49	
	1+1x21-39	1753	2,80	LTA852XD	01 02 27 49	
	1+1x28-54	2353	3,90	LT2853X	01 02 27 49	
	1+1x28-54	2353	3,90	LT2853XD	01 02 27 49	
	1+1x35-49	2953	4,70	LTA854X	01 02 27 49	
	1+1x35-49	2953	4,70	LTA854XD	01 02 27 49	
	1+1x80	2953	4,70	LTA855X	01 02 27 49	
	1+1x80	2953	4,70	LTA855XD	01 02 27 49	

Su richiesta versione Emergenza | Emergency version on request | Emergencia versione a demanda

\* DIFFUSORE MICROPRISMATICO A LUMINANZA CONTROLLATA (CONFORME NORMATIVA EN 12464-1) - CONTROLLED LUMINANCE MICROPRISMATIC DIFFUSER (CONFORMS TO STANDARD EN 12464-1) - DIFUSOR MICROPRISMATICO A LUMINANCIA CONTROLADA (SEGUN EN 12464-1)

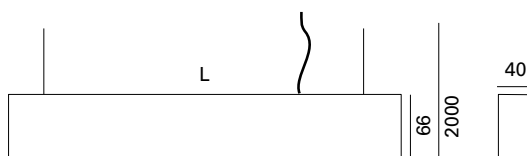

## FILE SOSPENSIONE FLUO CON DARK-LIGHT\*

FLUO WITH DARK-LIGHT- FLUO CON DARKLIGHT



T16	W	Lmm	Kg	CODE	Col.
	14-24	581	1,15	LT2844K	01 02 27 49
	21-39	881	1,45	LT2846K	01 02 27 49
	28-54	1181	2,15	LT2848K	01 02 27 49
	35-49-80	1481	2,50	LT2850K	01 02 27 49
	35-49-80	1481	2,50	LT2850KD	01 02 27 49
	1+1x21-39	1753	3,00	LTA852K	01 02 27 49
	1+1x21-39	1753	3,00	LTA852KD	01 02 27 49
	1+1x28-54	2353	3,90	LT2853K	01 02 27 49
	1+1x28-54	2353	3,90	LT2853KD	01 02 27 49
	1+1x35-49	2953	4,70	LTA854K	01 02 27 49
	1+1x35-49	2953	4,70	LTA854KD	01 02 27 49
	1+1x80	2953	4,70	LTA855K	01 02 27 49
	1+1x80	2953	4,70	LTA855KD	01 02 27 49



Su richiesta versione Emergenza | Emergency version on request | Emergencia versione bajo demanda

\* RIFLETTORE A LUMINANZA CONTROLLATA (CONFORME NORMATIVA EN 12464-1) - CONTROLLED LUMINANCE REFLECTOR (CONFORMS TO STANDARD EN 12464-1) - REFLECTORE A LUMINANCA CONTROLADA (SEGUN EN 12464-1)

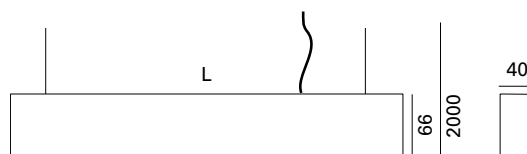

## FILE PARETE CON DIFFUSORE OPALINO

WALL WITH DIFFUSER- PARED CON DIFUSOR



LINEAR LED	W	K	lm product	lm/Led	CRI	Lmm	Kg	CODE	Col.
24W/MT 2200LM/MT	1x12,8	3000	736	1232	>80	580	1,20	LTC820	01 02 27 49
	1x19,2	3000	1104	1848	>80	860	1,40	LTC821	01 02 27 49
	1x25,6	3000	1472	2464	>80	1140	1,95	LTC822	01 02 27 49
	1x32	3000	1840	3080	>80	1420	2,20	LTC823	01 02 27 49
	1x38,4	3000	2208	3696	>80	1700	2,50	LTC824	01 02 27 49
	1x44,8	3000	2576	4312	>80	1985	2,90	LTC825	01 02 27 49
	1x51,2	3000	2944	4928	>80	2265	3,30	LTC826	01 02 27 49
	1x57,6	3000	3313	5544	>80	2545	3,90	LTC827	01 02 27 49
50000h Ta 25° L70B10	1x64	3000	3681	6160	>80	2825	4,40	LTC828	01 02 27 49



Su richiesta disponibile la versione 4000°K | On request available version 4000°K | Versión con 4000°K demanda

T16	W	Lmm	Kg	CODE	Col.
	1x14-24	581	1,20	LT2820	01 02 27 49
	1x21-39	881	1,40	LT2821	01 02 27 49
	1x28-54	1181	1,95	LT2822	01 02 27 49
	1x35-49-80	1481	2,30	LT2823	01 02 27 49
	1+1x21-39	1753	2,80	LTA821	01 02 27 49
	1+1x28-54	2353	3,50	LT2824	01 02 27 49
	1+1x35-49	2953	4,70	LTA825	01 02 27 49
	1+1x80	2953	4,70	LTB825	01 02 27 49



Su richiesta versioni Emergenza | Emergency version on request | Versiones de emergencia a demanda



01 - bianco - white - bianco    02 - nero - black - negro    27 - ossidato alluminio - oxidised aluminium - oxidado aluminio

49 - moka - moka - moka

Sistema modulare per illuminazione diretta, diffusa e/o d'accento, composto da profili vuoti in estruso di alluminio verniciato o anodizzato 66x40 mm. di lunghezza predefinita o tagliabili a misura, disponibili nelle versioni a parete, plafone, sospensione, a incasso con cornice di battuta super-slim larghezza 5 mm. (61,5x40 mm.) e a incasso rasato a scomparsa totale trimless. Da integrare con sorgenti lineari LED, reglette per lampade fluorescenti T16, proiettori con sorgente LED integrata e moduli binario max 16A 3 accensioni per inserimento di proiettori. Reglette fluorescenti complete di alimentazione elettronica 50/60Hz 230/240V. Reglette LED con driver integrati. Da completare con le testate di chiusura laterali con sistema Light Proof, schermo diffondente in PC opalino bianco o microprismatico a luminanza controllata (conforme normativa EN 12464-1), profili di chiusura, di lunghezza predefinita o tagliabili a misura, o griglia dark-light in alluminio ad alta specularità e staffe di fissaggio o cavi di sospensione. Grado di protezione IP40.

Modular system for direct, diffused and/or accent lighting, consisting of hollow profiles made from 66x40 mm painted or anodised extruded aluminium, with a predefined length or cut to measure, available in the following versions: wall-mounted, ceiling-mounted, suspended, recessed with a super-slim edge trim, just 5 mm wide (61.5 x 40 mm) and trimless recessed. To be integrated with LED linear light sources, battens for T16 fluorescent lamps, projectors with built-in LED source and max 16A 3-circuit track modules for inclusion of projectors. Fluorescent battens, complete with 50/60 Hz 230/240 V electronic power supply, LED batten driver included. To be completed with side end caps with Light Proof system, opal white or microprismatic PC diffusing screen (in accordance with EN 12464-1), closing profiles, with a predefined length or cut to measure, or dark-light aluminium grille with high specular qualities and mounting brackets or suspension cables. IP40 protection rating.

Sistema modular para la iluminación directa, difusa y/o concentrada. Compuesto de perfil vacío en estruso de aluminio barnizado o anodizado 66x40 mm. de largo predefinida o cortable a medida, disponible en la versiones de pared, plafón, suspensión, empotrado con bordillo súper-fino "super-slim" de 5 mm. (61,5x40 mm.) y total empotrado. Preparados para fuentes luminosas lineales LED, regletas para lámparas fluorescentes T16 y T16 seamless, proyectores con fuente luminosa LED integrada y rieles binarios 16A, para la colocación de proyectores. Regletas para lámparas fluorescentes con alimentación electrónica 50/60Hz 230/240V, reglette Led con alimentador incluido. Se complementan con las tapas de cierre laterales con sistema "Light Proof", difusor en PC blanco opal o micro prismático (conforme normativa EN 12464-1), perfil de cierre, de longitud predefinida o cortable a medida, o difusor dark-light en aluminio de gran luminosidad, soporte de fijación o cables de suspensión. Grado de protección IP40.

## FILE SISTEMA



USO ESTERNO ROMA - ITALY  
PROJECT ARCH. A. PETRINI  
LIGHTING CONCEPT R. PARACIANI  
PHOTO ER STUDIO



HAMAD GENERAL HOSPITAL - QATAR  
PROJECT ARCH. NET MIMARLIK





**PROFILO VUOTO INCASSO**

RECESSED EMPTY PROFILE- PERFIL VACIO EMPOTRABLE



L.mm	Kg	CODE	Col.
1000	0.93	LT2471000	01 02 27
2000	1.86	LT2472000	01 02 27
3000	2.79	LT2473000	01 02 27
.....		LT247misura*	01 02 27

**PROFILO VUOTO INCASSO X**

X-SHAPED RECESSED EMPTY PROFILE- PERFIL VACIO EMPOTRABLE X



Dim.	CODE	Col.
620x570	LT247X	01 02 27

Molle per fissare il profilo al cartongesso incluse |  
Spring to fix the perfil to the false ceiling included |  
muelle para la fijación del perfil en el falso  
techo incluido.

**PROFILO VUOTO INCASSO 90°**

90°-SHAPED RECESSED EMPTY PROFILE - PERFIL VACIO EMPOTRABLE 90°



Dim.	CODE	Col.
320x290	LT24790	01 02 27

Molle per fissare il profilo al cartongesso incluse |  
Spring to fix the perfil to the false ceiling included |  
muelle para la fijación del perfil en el falso  
techo incluido.

**PROFILO VUOTO INCASSOT**

T-SHAPED RECESSED EMPTY PROFILE - PERFIL VACIO EMPOTRABLE T



Dim.	CODE	Col.
565x320	LT247T	01 02 27

Molle per fissare il profilo al cartongesso incluse |  
Spring to fix the perfil to the false ceiling included |  
muelle para la fijación del perfil en el falso  
techo incluido

**COPPIA TESTATE INCASSO**

COUPLE OF CLOSURE HEADS - TAPAS FINAL



CODE	Col.
LT2470	01 02 27

**PROFILO INCASSO PER PARETE/SOFFITTO**

FOR WALL/CEILING - POR PARED/TECHO



Dim.	CODE	Col.
280+60x280+60	LT247PS	01 02 27

Molle per fissare il profilo al cartongesso incluse |  
Spring to fix the perfil to the false ceiling included |  
muelle para la fijación del perfil en el falso  
techo incluido.

**MOLLA SINGOLA INCASSO**

SINGLE SPRING - RESORTE ÚNICO



CODE
LT2426

Molla singola per fissare il profilo al controsoffitto.  
una ogni metro lineare. Minimo 2 pezzi - Single pring  
for fixing the profile on the false-ceiling. one every  
linear metre. 2 pcs minimum) - Resorte único para  
la fijación del perfil en el falso techo. uno cada 1 mt.  
Minimo 2 piezas.

\*Tramite questo codice è possibile ordinare il profilo in una lunghezza lineare non standard. Sostituire alla parola "misura" la lunghezza desiderata in mm. Per ordinare un profilo con una o entrambe le estremità tagliate ad angolo 45° aggiungere alla misura la lettera "D" (taglio Destro) o "S" (taglio Sinistro). Seguire istruzioni riportate a pag. 834. Per profili oltre i 3 mt e massimo 6 mt le condizioni di trasporto sono da concordare. || \*Through this code it's possible to order the profile in a not-standard linear length. Replace the word "misura" with the desired length in mm. To order a profile with one or both ends 45° angle-cut add the letter "D" (right cut) or "S" (left cut) to the standard or custom length. Follow the instructions on page 834. For lengths over 3 mt. to max. 6 mt. transport conditions to negotiate. || \*el uso de este código, se puede ordenar el perfil en un lineal longitud no estándar. Sustitúyase la palabra "medida" de la longitud en mm. Para pedir un perfil con uno o ambos extremos cortados en un ángulo de 45° a añadir a la medida de la letra "D" (derecha cortada) o "S" (izquierda cortada). Sigla las instrucciones de la página. 834. Perfiles para más de 3 my 6 m Condiciones máximas de transporte a convenir.

01 - bianco - white - bianco    02 - nero - black - negro    27 - ossidato alluminio - oxidised aluminium - oxidado aluminio



## PROFILO VUOTO INCASSO RASATO

TOTAL RECESSED EMPTY PROFILE - PERFIL VACIO TOTAL EMPOTRABLE



Lmm	Kg	CODE	Col.
1000	0.95	LT248.1000	01
2000	2.00	LT248.2000	01
3000	2.60	LT248.3000	01
.....		LT248.misura* 01	

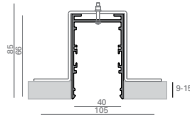

## PROFILO VUOTO INCASSO RASATO X

X-SHAPED TOTAL RECESSED EMPTY PROFILE- PERFIL VACIO TOTAL EMPOTRABLE X



Dim.	CODE	Col.
600x570	LT248.X	01

Staffe per fissare il profilo al cartongesso include |  
Spring to fix the perfil to the false ceiling included |  
Soporte para la fijación del perfil en el falso techo incluido

## COPPIA DITESTATE INCASSO RASATO

COUPLE OF CLOSURE HEADS - PAREJA DE TAPAS FINALES



CODE	Col.
LT248	01

## PROFILO RASATO PER PARETE/SOFFITTO

TRIMLESS RECESSED EMPTY ANGLE PROFILE - TOTAL EMPOTRABLE PERFIL VACIO PARED/TECHO



Dim.	CODE	Col.
280+60x280+60	LT248.PS	01

Per fissare il profilo al cartongesso, una ogni metro-lineare | Fix the perfil to the false ceiling, one every linear meter | para la fijación del perfil en el falso techo, una muelle cada 1 metros

## PROFILO VUOTO INCASSO RASATO 90°

90°-SHAPED TRIMLESS RECESSED EMPTY PROFILE- PERFIL VACIO TOTAL EMPOTRABLE 90°



Dim.	CODE	Col.
315x285	LT248.90	01

Staffe per fissare il profilo al cartongesso include |  
Brackets to fix the perfil to the false ceiling included |  
Soporte para la fijación del perfil en el falso techo incluido

## STAFFA SINGOLA INCASSO RASATO

SINGLE BRACKET- SOPORTE INDIVIDUAL



CODE
LT248S

Per fissare il profilo al cartongesso, una ogni metro-lineare. Minimo 2 pezzi | Single bracket to fix the perfil to the false ceiling, one every linear meter. Min. 2pcs. | para la fijación del perfil en el falso una soporte cada 1 metros. Minimo 2 piezas.

## PROFILO VUOTO INCASSO RASATO T

T-SHAPED TRIMLESS RECESSED EMPTY PROFILE - PERFIL VACIO TOTAL EMPOTRABLE T



Dim.	CODE	Col.
565x320	LT248.T	01

Staffe per fissare il profilo al cartongesso include |  
Brackets to fix the perfil to the false ceiling included |  
Soporte para la fijación del perfil en el falso techo incluido

01 - bianco - white - bianco

## PROFILO VUOTO SOFFITTO

CEILING EMPTY PROFILE- PERFIL VACIO TECHO



Lmm	Kg	CODE	Col.
1000	0.95	LT243.1000	01 02 27 49
2000	2.00	LT243.2000	01 02 27 49
3000	2.60	LT243.3000	01 02 27 49
.....		LT243.misura*	01 02 27 49

## COPPIA DITESTATE DI CHIUSURA

COUPLE OF CLOSURE HEADS - PAREJA DE TAPAS FINALES



CODE	Col.
LT2403	01 02 27 49

## PROFILO VUOTO SOFFITTO X

PROFILO VUOTO SOFFITTO X- EMPTY PROFILE CEILING X- PERFIL VACIO TECHO X



Dim.	CODE	Col.
620x570	LT243.X	01 02 27 49

## PROFILO VUOTO SOFFITTO T

T-SHAPED CEILING EMPTY PROFILE - PERFIL VACIO TECHO T



Dim.	CODE	Col.
565x320	LT243.T	01 02 27 49

## PROFILO VUOTO SOFFITTO 90°

90°-SHAPED CEILING EMPTY PROFILE - PERFIL VACIO TECHO 90°



Dim.	CODE	Col.
320x290	LT243.90	01 02 27 49

## PROFILO PER PARETE/SOFFITTO

FOR WALL/CEILING - POR PARED/TECHO



Dim.	CODE	Col.
280+60x280+60	LT243.PS	01 02 27 49

01 - bianco - white - bianco
  02 - nero - black - negro
  27 - ossidato alluminio - oxidised aluminium - oxidado aluminio
  49 - moka - moka - moka

## PROFILO VUOTO SOSPENSIONE

SUSPENSION EMPTY PROFILE- PERFIL VACIO SUSPENSION

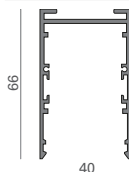

Lmm	Kg	CODE	Col.
1000	0.95	LTB43.1000	01 02 27 49
2000	2.00	LTB43.2000	01 02 27 49
3000	2.60	LTB43.3000	01 02 27 49
.....		LTB43.misura*	01 02 27 49

## COPPIA DITESTATE DI CHIUSURA

COUPLE OF CLOSURE HEADS - PAREJA DE TAPAS FINALES



CODE	Col.
LT2403	01 02 27 49

## CAVI SOSPENSIONE IN ACCIAIO

STEEL SUSPENSION CABLE- CABLE SUSPENSION EN ACERO



Lmm	Kg	CODE
2000	0.16	LT2410
4000	0.32	LT2410.4000

Uno ogni 2 mt., minimo 2 | Suspension cable. one every 2 mt, 2 pieces minimum | Cable suspension. uno cada 2 mt minimo de 2.

## KIT ALIMENTAZIONE COMPLETO DI ROSONE

POWER CABLE KIT WITH CEILING CANOPY- KIT ALIMENTACION CON FLORON



Dim.	Lmm	Kg	CODE	Col.
3X1	2000	0.18	LT2411	01
3X1	4000	0.36	LT2411.4000	01
4X1	2000	0.26	LT2412	01
4X1	4000	0.52	LT2412.4000	01
5X1	2000	0.30	LT2412.5	01
5X1	4000	0.60	LT2412.5.4000	01
7X1	2000	0.30	LT2412.7	01
7X1	4000	0.60	LT2412.7.4000	01
9X1	2000	0.30	LT2412.9	01
9X1	4000	0.60	LT2412.9.4000	01

\*Tramite questo codice è possibile ordinare il profilo in una lunghezza lineare non standard. Sostituire alla parola "misura" la lunghezza desiderata in mm. Per ordinare un profilo con una o entrambe le estremità tagliate ad angolo 45° aggiungere alla misura la lettera "D" (taglio Destro) o "S" (taglio Sinistro). Seguire istruzioni riportate a pag. 834. Per profili oltre i 3 mt e massimo 6 mt le condizioni di trasporto sono da concordare. || \*Through this code it's possible to order the profile in a not-standard linear length. Replace the word "misura" with the desired length in mm. To order a profile with one or both ends 45° angle-cut add the letter "D" (right cut) or "S" (left cut) to the standard or custom length. follow the instructions on page 834. for lengths over 3 mt. to max. 6 mt. transport conditions to negotiate. || \*el uso de este código, se puede ordenar el perfil en un lineal longitud no estándar. Sustitúyase la palabra "medida" de la longitud en mm. Para pedir un perfil con uno o ambos extremos cortados en un ángulo de 45° a añadir a la medida de la letra "D" (derecha cortada) o "S" (izquierda cortada). Siga las instrucciones de la página. 834. Perfiles para más de 3 my 6 m Condiciones máximas de transporte a convenir.

## PROFILO VUOTO PARETE

WALL EMPTY PROFILE- PERFIL VACIO PAREDE



Lmm	Kg	CODE	Col.
1000	0.95	LTA43.1000	01 02 27 49
2000	2.00	LTA43.2000	01 02 27 49
3000	2.60	LTA43.3000	01 02 27 49
.....		LTA43.misura*	01 02 27 49

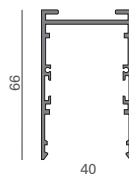

## COPPIA DITESTATE DI CHIUSURA

COUPLE OF CLOSURE HEADS - PAREJA DE TAPAS FINALES



CODE	Col.
LT2403	01 02 27 49

## DISTANZIALE DA POSIZIONARE TRA PROFILO PARETE

SINGLE SPACER TO PUT BETWEEN PROFILE AND WALL- ESPACIADOR INDIVIDUAL PARA SER COLOCADO ENTRE EL PERFIL Y LA PARED





CODE
LTX001

Uno ogni 1/1,5 mt | one every 1/1,5 mt | uno cada 1/1,5 mt

01 - bianco - white - bianco
  02 - nero - black - negro
  27 - ossidato alluminio - oxidised aluminium - oxidado aluminio
  49 - moka - moka - moka

## FILE REGLETTE LED 24W/MT



24W/MT LED BATTEN- REGLETTE LED 24W/MT

	W	K	lm product	lm/Led	CRI	DaliT&D	Lmm	CODE			
 <p>LINEAR LED 24W/MT 2200lm/MT CRI&gt;80 230V</p>	12,8	3000	1232	1232	>80		560	RLF3M01	 <p>50000h Ta 25° L70B10</p> <p><b>A+</b></p> <p>IP20 SELV</p>		
	12,8	3000	1232	1232	>80	x	560	RLF3M01D			
	19,2	3000	1848	1848	>80		840	RLF3M02			
	19,2	3000	1848	1848	>80	x	840	RLF3M02D			
	25,6	3000	2464	2464	>80		1120	RLF3M03			
	25,6	3000	2464	2464	>80	x	1120	RLF3M03D			
	32	3000	3080	3080	>80		1400	RLF3M04			
	32	3000	3080	3080	>80	x	1400	RLF3M04D			
	38,4	3000	3696	3696	>80		1680	RLF3M05			
	38,4	3000	3696	3696	>80	x	1680	RLF3M05D			
	51,2	3000	4928	4928	>80		2240	RLF3M07			
	51,2	3000	4928	4928	>80	x	2240	RLF3M07D			
	<p>LINEAR LED 24W/MT 2285lm/MT CRI&gt;80</p>	12,8	4000	1280	1280	>80		560		RLF4M01	<p>50000h Ta 25° L70B10</p> <p><b>A+</b></p> <p>IP20 SELV</p>
		12,8	4000	1280	1280	>80	x	560		RLF4M01D	
19,2		4000	1920	1920	>80		840	RLF4M02			
19,2		4000	1920	1920	>80	x	840	RLF4M02D			
25,6		4000	2560	2560	>80		1120	RLF4M03			
25,6		4000	2560	2560	>80	x	1120	RLF4M03D			
32		4000	3200	3200	>80		1400	RLF4M04			
32		4000	3200	3200	>80	x	1400	RLF4M04D			
38,4		4000	3840	3840	>80		1680	RLF4M05			
38,4		4000	3840	3840	>80	x	1680	RLF4M05D			
51,2		4000	5120	5120	>80		2240	RLF4M07			
51,2		4000	5120	5120	>80	x	2240	RLF4M07D			

alimentatore incluso | included ballast | con trasformador

## FILE REGLETTE LED 41W/MT

41W/MT LED BATTEN- REGLETTE LED 41W/MT

	W	K	lm product	lm/Led	CRI	DaliT&D	Lmm	CODE			
 <p>LINEAR LED 41W/MT 4640lm/MT CRI90</p>	22,8	3000	2600	2600	90		560	RLF3H01	 <p><b>A+</b></p> <p>IP20 SELV</p>		
	22,8	3000	2600	2600	90	x	560	RLF3H01D			
	34,2	3000	3900	3900	90		840	RLF3H02			
	34,2	3000	3900	3900	90	x	840	RLF3H02D			
	45,6	3000	5200	5200	90		1120	RLF3H03			
	45,6	3000	5200	5200	90	x	1120	RLF3H03D			
	57	3000	6500	6500	90		1400	RLF3H04			
	57	3000	6500	6500	90	x	1400	RLF3H04D			
	68,4	3000	7800	7800	90		1680	RLF3H05			
	68,4	3000	7800	7800	90	x	1680	RLF3H05D			
	91,2	3000	10400	10400	90		2240	RLF3H07			
	91,2	3000	10400	10400	90	x	2240	RLF3H07D			
	<p>LINEAR LED 41W/MT 4820lm/MT CRI90</p>	22,8	4000	2700	2700	90		560		RLF4H01	<p>IP20 SELV</p>
		22,8	4000	2700	2700	90	x	560		RLF4H01D	
34,2		4000	4050	4050	90		840	RLF4H02			
34,2		4000	4050	4050	90	x	840	RLF4H02D			
45,6		4000	5400	5400	90		1120	RLF4H03			
45,6		4000	5400	5400	90	x	1120	RLF4H03D			
57		4000	6750	6750	90		1400	RLF4H04			
57		4000	6750	6750	90	x	1400	RLF4H04D			
68,4		4000	8100	8100	90		1680	RLF4H05			
68,4		4000	8100	8100	90	x	1680	RLF4H05D			
91,2		4000	10800	10800	90		2240	RLF4H07			
91,2		4000	10800	10800	90	x	2240	RLF4H07D			

alimentatore incluso | included ballast | con trasformador

## REGLETTE MONOLAMPADA FLUORESCENTE

SINGLE FLUO BATTEN - REGLETTE MONO FLUO

	T16 G5 230V	W	DaliT&D	Lmm	Kg	CODE
		14-24		573	0.40	<b>LT2440.14-24</b>
		14-24	x	573	0.40	<b>LT40.14-24D</b>
		21-39		873	0.47	<b>LT2442.21-39</b>
		21-39	x	873	0.47	<b>LT42.21-39D</b>
		28-54		1173	0.52	<b>LT2444.28-54</b>
		28-54	x	1173	0.52	<b>LT44.28-54D</b>
		35-49-80		1473	0.90	<b>LT2446.35-49-80</b>
		35-49-80	x	1473	0.90	<b>LT46.35-80D</b>

Versione Emergenza su richiesta | emergency version on request | Versione emergencia a demanda.

## PARATIA DIVISORIA SINGOLA MODULO FLUO/BINARIO

INTERMEDIATE SINGLE HEAD FOR FLUO/ TRACK MODULE- TAPA SINGULO INTERMEDIO MODULO FLUO/CARRIL

	CODE	Col.
	<b>LTPF1</b>	<b>01</b>

## STRIP BOBINA DA 5 METRI

STRIP LED 5 METERS ROLL- BOBINA STRIP LED 5 METROS

	LINEAR LED 24V	W/mt	V	Led/mt	lm/mt	K	lm product	lm/W	CRI	IP	A	Lmm	Kg	CODE
		5,5	24	60	270	3000	1350	245	80	20	V.1	5000	0,18	<b>ST05.30.5</b>
		9,6	24	120	540	3000	2700	281	80	20	V.1	5000	0,18	<b>ST10.30.5</b>
		11	24	180	1200	3000	6000	545	80	20	V.1	5000	0,18	<b>ST11.30.5</b>
		18	24	168	2200	3000	11000	611	80	20	V.1	5000	0,18	<b>ST21.30.5</b>

	LINEAR LED IP65 24V	W/mt	V	Led/mt	lm/mt	K	lm product	lm/W	CRI	IP	A	Lmm	Kg	CODE
		9,6	24	120	540	3000	2700	281	80	65	V.1	5000	0,18	<b>ST10.30.5IP</b>
		14,4	24	60	900	3000	4500	313	80	65	V.1	5000	0,18	<b>ST15.30.5IP</b>
		19,2	24	240	1080	3000	5400	281	80	65	V.1	5000	0,18	<b>ST20.30.5IP</b>

## DISSIPATORE PER STRIP LED

DISSIPATORE PER STRIP LED- HEAT SINCK FOR STRIP LED- DISIPADOR PARA STRIP LED

	Lmm	CODE
	1000	<b>LTC1.1000</b>
	2000	<b>LTC1.2000</b>
	3000	<b>LTC1.3000</b>
	.....	<b>LTC1.misura*</b>

\*Tramite questo codice è possibile ordinare il profilo in una lunghezza lineare non standard. Sostituire alla parola "misura" la lunghezza desiderata in mm. Per profili oltre i 3 mt e massimo 6 mt le condizioni di trasporto sono da concordare. | \*Through this code it's possible to order the profile in a not-standard linear lenght. Replace the word "misura" with the desired lenght in mm. | \*El uso de este código, se puede ordenar el perfil en un lineal longitud no estándar. Sustitúyase la palabra "medida" de la longitud en mm. Perfiles para más de 3 my 6 m Condiciones máximas de transporte a convenir..

01 - bianco - white - blanco



pag.824



pag.820

## MODULO BINARIO EUROSTANDARD 230V 16A ON/OFF DALI 1-10V

230V TRACK MODULE - MODULO CARRIL



Lmm	Kg	CODE	Col.
1000	0.92	LT24T1000	01 02
2000	1.83	LT24T2000	01 02
3000	2.75	LT24T3000	01 02

Da completare con gli accessori | To complete with accessories | Para completar con accesorios

## ALIMENTAZIONE DI TESTA DX

RIGHT HEAD FEED FOR TRACK SYSTEM - ALIMENTACIÓN DE CABECERA DERECHA TRACK SYSTEM

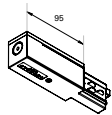

CODE	Col.
LT9020.1	01 02

Possibilità di gestione separata di tre circuiti On/Off oppure di gestione tramite segnale digitale (DALI)

## ALIMENTAZIONE DI TESTA SX

LEFT HEAD FEED FOR TRACK SYSTEM - ALIMENTACIÓN DE CABECERA IZQUIERDA TRACK SYSTEM

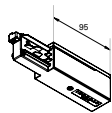

CODE	Col.
LT9021.1	01 02

Possibilità di gestione separata di tre circuiti On/Off oppure di gestione tramite segnale digitale (DALI)

## GIUNTO LINEARE

CONNECTOR FOR TRACK SYSTEM - UNIONES TRACK SYSTEM



CODE	Col.
LT9023.1	01 02

## TAPPO DI CHIUSURA

BLIND END TRACK SYSTEM - TAPA DE CIERRE TRACK SYSTEM



CODE	Col.
LT9033.1	01 02

01 - bianco - white - blanco 02 - nero - black - negro

VEDI PROIETTORI DA BINARIO - SEE PROJECTORS FOR TRACK - VER PROYECTORES POR CARRIL PAG.574

**DIFFUSORE IN POLICARBONATO OPALINO BIANCO**

OPAL WHITE POLYCARBONATE DIFFUSER- DIFUSOR OPALINO BLANCO EN POLICARBONATO



Lmm	Kg	CODE
1000	0.16	LT239P1000
2000	0.33	LT239P2000
3000	0.50	LT239P3000
.....		LT239Pmisura*

**DIFFUSORE IN POLICARBONATO MICROPRISMATICO\***

MICROPRISMATIC POLYCARBONATE DIFFUSER- DIFUSOR EN POLICARBONATO MICROPRISMATICO



Lmm	Kg	CODE
1000	0.16	LT239X.1000
2000	0.33	LT239X.2000
3000	0.50	LT239X.3000
.....		LT239X.misura*

\* DIFFUSORE MICROPRISMATICO A LUMINANZA CONTROLLATA (CONFORME NORMATIVA EN 12464-1) - CONTROLLED LUMINANCE MICROPRISMATIC DIFFUSER (CONFORMS TO STANDARD EN 12464-1) - DIFUSOR MICROPRISMATICO A LUMINANCIA CONTROLADA (SEGÚN EN 12464-1)

**RIFLETTORE DARK-LIGHT\***

DARK-LIGHT REFLECTOR- REFLECTOR DARK-LIGHT



Lmm	Kg	CODE
573	0.05	LT2397
873	0.08	LT2398
1173	0.11	LT2399
1473	0.14	LT2400

Abbinabile solo a moduli fluorescenti con lampade T16 standard | Suitable for fluorescent T16 standard lamps only | Sólo se pueden combinar con las lámparas fluorescentes T16 estándar

\* RIFLETTORE A LUMINANZA CONTROLLATA (CONFORME NORMATIVA EN 12464-1) - CONTROLLED LUMINANCE REFLECTOR (CONFORMS TO STANDARD EN 12464-1) - REFLECTORE A LUMINANCIA CONTROLADA (SEGÚN EN 12464-1)

**PROFILO DI CHIUSURA IN ESTRUSO DI ALLUMINIO**

PROFILO DI CHIUSURA IN ESTRUSO DI ALLUMINIO- EXTRUDED ALUMINIUM CLOSING COVER- TAPA EN EXTRUSO DE ALUMINIO



Lmm	CODE	Col.
1000	LTT1.1000	01 02 27 49
2000	LTT1.2000	01 02 27 49
3000	LTT1.3000	01 02 27 49
.....	LTT1.misura*	01 02 27 49

 01 - bianco - white - bianco

 02 - nero - black - negro

 27 - ossidato alluminio - oxidised aluminium - oxidado aluminio

 49 - moka - moka - moka



## GIUNTI LINEARI COPPIA

LINEAR CONNECTORS- CONECTORES LINEARES PAREJA



Kg  
0.05

CODE  
LT2406

## COPPIA GIUNTI ANGOLARI

ANGLE CONNECTOR COUPLE- CONNECTOR ANGULO



CODE  
LTM211.90

## COPPIA GIUNTI ANGOLARI PARETE/SOFITTO



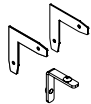

WALL-CEILING ANGLE CONNECTOR COUPLE- CONNECTOR ANGULO





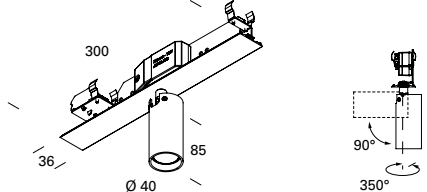

CODE  
LTM211.90P

\*Tramite questo codice è possibile ordinare il profilo in una lunghezza lineare non standard. Sostituire alla parola "misura" la lunghezza desiderata in mm. Per ordinare un profilo con una o entrambe le estremità tagliate ad angolo 45° aggiungere alla misura la lettera "D" (taglio Destro) o "S" (taglio Sinistro). Seguire istruzioni riportate a pag. 834. Per profili oltre i 3 mt e massimo 6 mt le condizioni di trasporto sono da concordare. || \*Through this code it's possible to order the profile in a not-standard linear length. Replace the word "misura" with the desired length in mm. To order a profile with one or both ends 45° angle-cut add the letter "D" (right cut) or "S" (left cut) to the standard or custom length. follow the instructions on page 834. for lengths over 3 mt. to max. 6 mt. transport conditions to negotiate. || \*el uso de este código, se puede ordenar el perfil en un lineal longitud no estándar. Sustitúyase la palabra "medida" de la longitud en mm. Para pedir un perfil con uno o ambos extremos cortados en un ángulo de 45 ° a añadir a la medida de la letra "D" (derecha cortada) o "S" (izquierda cortada). Siga las instrucciones de la página. 834. Perfiles para más de 3 my 6 m Condiciones máximas de transporte a convenir.



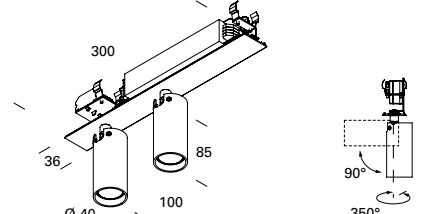

## FARETEN FOCUS 41S

	W	K	lm product	lm/Led	CRI	Dali	△	Dim.	Lmm	H	CODE	Col.	
 <p>LED</p> <p>50000h L90 B10 ta 25°C</p> <p><b>A+</b></p>	5	2700	310	395	95		22°	ø40	300x36	85	<b>FR021.927F 01 02</b> <b>FR021.927FD 01 02</b> <b>FR021.930F 01 02</b> <b>FR021.930FD 01 02</b>	   	
	5	2700	310	395	95	x	22°	ø40	300x36	85			
	5	3000	310	395	95		22°	ø40	300x36	85			
	5	3000	310	395	95	x	22°	ø40	300x36	85			
	5	3000	310	395	95	x	22°	ø40	300x36	85			
													

## FARETEN FOCUS 42S

	W	K	lm product	lm/Led	CRI	Dali	△	Dim.	Lmm	H	CODE	Col.	
 <p>LED</p> <p>50000h L90 B10 ta 25°C</p> <p><b>A+</b></p>	2x5	2700	620	790	95		22°	ø40	300x36	85	<b>FR022.927F 01 02</b> <b>FR022.927FD 01 02</b> <b>FR022.930F 01 02</b> <b>FR022.930FD 01 02</b>	   	
	2x5	2700	620	790	95	x	22°	ø40	300x36	85			
	2x5	3000	620	790	95		22°	ø40	300x36	85			
	2x5	3000	620	790	95	x	22°	ø40	300x36	85			
	2x5	3000	620	790	95	x	22°	ø40	300x36	85			
													

## FARETEN MINISPOT S

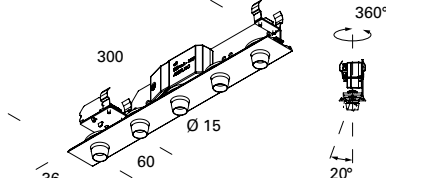
	W	K	lm product	lm/Led	CRI	Dali	△	Dim.	Lmm	CODE	Col.	
 <p>LED</p> <p><b>A+</b></p>	5x1,5	2700	432	415	95		15°	ø20	300x36	<b>FR023.927S 01 02</b> <b>FR023.927SD 01 02</b> <b>FR023.930S 01 02</b> <b>FR023.930SD 01 02</b>	   	
	5x1,5	2700	432	415	95	x	15°	ø20	300x36			
	5x1,5	3000	625	600	95		15°	ø20	300x36			
	5x1,5	3000	625	600	95	x	15°	ø20	300x36			
	5x1,5	3000	625	600	95	x	15°	ø20	300x36			
												

□ 01 - bianco - white - bianco    ■ 02 - nero - black - negro



**CASSAFORMA/CONTAINER**

FILE WALLBOX- FILE ENCOFRADO



Dim.	H	Lmm	CODE	Col.
57	98	1000	LTF1.1000	01 02 27
57	98	2000	LTF1.2000	01 02 27
57	98	3000	LTF1.3000	01 02 27
57	98	.....	LTF1.misura*	01 02 27

**CASSAFORMA GIUNTO X**

X - SHAPED EMPTY PROFILE X- PERFIL VACIO X



Dim.	CODE	Col.
605x565	LTF1.X	01 02 27

**CASSAFORMA GIUNTO 90°**

90°-SHAPED EMPTY PROFILE - PERFIL VACIO 90°



Dim.	CODE	Col.
325x285	LTF1.90	01 02 27

**CASSAFORMA GIUNTO T**

T - SHAPED EMPTY PROFILE - PERFIL VACIO LADRILLO/CARTON-YESO T



Dim.	CODE	Col.
565x325	LTF1.T	01 02 27

**COPPIA DI TESTATE**

COUPLE OF CLOSURE HEADS - TAPAS FINAL POR ENCOFRADO



CODE	Col.
LT2480	01 02 27

**CASSAFORMA PARETE/SOFFITTO**

WALL/CEILING-EMPTY PROFILE PERFIL VACIO PARED/TECHO



Dim.	CODE	Col.
280+94x280+94	LTF1.PS	01 02 27

\*Tramite questo codice è possibile ordinare il profilo in una lunghezza lineare non standard. Sostituire alla parola "misura" la lunghezza desiderata in mm. Per ordinare un profilo con una o entrambe le estremità tagliate ad angolo 45° aggiungere alla misura la lettera "D" (taglio Destro) o "S" (taglio Sinistro). Seguire istruzioni riportate a pag. 834. Per profili oltre i 3 mt e massimo 6 mt le condizioni di trasporto sono da concordare. || \*Through this code it's possible to order the profile in a not-standard linear length. Replace the word "misura" with the desired length in mm. To order a profile with one or both ends 45° angle-cut add the letter "D" (right cut) or "S" (left cut) to the standard or custom length. Follow the instructions on page 834. for lengths over 3 mt. to max. 6 mt. transport conditions to negotiate. | | \*el uso de este código, se puede ordenar el perfil en un lineal longitud no estándar. Sustitúyase la palabra "medida" de la longitud en mm. Para pedir un perfil con uno o ambos extremos cortados en un ángulo de 45° a añadir a la medida de la letra "D" (derecha cortada) o "S" (izquierda cortada). Siga las instrucciones de la página. 834. Perfiles para más de 3 my 6 m Condiciones máximas de transporte a convenir.

□ 01 - bianco - white - bianco    ■ 02 - nero - black - negro    □ 27 - ossidato alluminio - oxidised aluminium - oxidado aluminio

## GIUNTI LINEARI COPPIA

GIUNTI LINEARI COPPIA PER CASSAFORMA- LINEAR JOINT COUPLE FOR WALLBOX- CAJA PAREJA DE LINEAL UNION



Kg  
0,05

CODE  
LT2482

## GIUNTI ANGOLARI COPPIA

GIUNTI ANGOLARI COPPIA- ANGLE CONNECTORS COUPLE- CONNECTOR ANGULO PAREJA



CODE  
LTM211.90

## COPPIA DI STAFFE DI FISSAGGIO PER CARTONGESSO

COPPIA DI STAFFE DI FISSAGGIO PER CARTONGESSO - COUPLE OF FIXING BRACKETS IN THE FALSE-CEILING - PAREJA DE SOPORTES PARA FIJACIÓN EN FALSO TECHO



CODE  
LTSC01

Coppia di staffe di fissaggio per cartongesso 1 ogni 1,5 mt. - couple of fixing brackets for false-ceiling 1 every 0,5 mt. - pareja de soportes para fijación en falso techo 1 por 1,5 mt.

## STAFFA SINGOLA PER CASSAFORMA

STAFFA SINGOLA MINIFILE - SINGLE BRACKET- SOPORTE INDIVIDUAL



CODE  
LTM210

staffa per fissaggio modulo luminoso all'interno della cassaforma. ordinare 1 al mt. (minimo 2 pezzi) | Single bracket to fix the lighting module within the wallbox, order 1 per mt. (min. 2 pcs) | soporte individual por fijar el encofrado, solicite 1 por mt. (2pcs mínimo)

## FASCETTA REGGICAVO PER CASSAFORMA

FASCETTA REGGICAVO- TIE CABLE LOCKING- ABRAZADERA DE CABLE



CODE  
LTSC02

Fascetta reggicavo - ordinare 1 ogni 0,5 mt (minimo 2pezzi) - Tie cable locking - order 1 per 0,5 mt. (min.2pcs) - Abrazadera de cable - solicite 1 por 0,5 mt. (2pcs mínimo)

Serie di apparecchi a sospensione e a parete per illuminazione diretta e indiretta diffusa, per sorgenti lineari LED o lampade fluorescenti T16 e T16 seamless. Alimentazione elettronica integrata 50/60Hz 230/240V. Corpo in estruso di alluminio 120x40mm. Finitura verniciata o anodizzata. Completi di cavi di sospensione in acciaio con sistema di regolazione micrometrica e cavo di alimentazione l. 2000 mm., testate di chiusura laterali con sistema Light Proof e schermo diffondente in PC opalino bianco o microprismatico (conforme normativa EN12464-1) o griglia dark-light in alluminio ad alta specularità. Grado di protezione IP20 o IP40.

Series of suspended and wall-mounted fixtures for direct and indirect diffused lighting. For integrated linear LED sources or for T16 and seamless T16 fluorescent lamps. 230/240V 50/60Hz integrated electronic supply. Body in 120x40 mm. extruded aluminium. Painted or anodized finish. Complete with steel suspension cables with micrometric regulation system and feed cable l. 2000 mm., with Light Proof system side end caps and opal white or microprismatic (conform to EN 12464-1 EU directive) polycarbonate diffuser or high efficiency dark-light aluminium grid. Protection degree IP20 or IP40.

Serie de aparatos a suspensión y a pared de iluminación directa, difusa y/o concentrada preparados para fuentes luminosas lineales LED y para lámparas fluorescentes T16 y T16 seamless, con alimentación electrónica integrada 50/60Hz 230/240V. Perfil en estruso de aluminio barnizado o anodizado 120x40 mm.. Completo de cables de suspensión de acero con sistema de regulación micrométrica y el cable de alimentación. 2000 mm, con las cable tapas de cierre laterales con sistema "Light Proof", difusor en policarbonato blanco opal o micro prismático (conforme normativa EN 12464-1), o difusor dark-light en aluminio de gran luminosidad. Grado de protección IP20 o IP40.

**FILE H**





FATRO SPA - OZZANO (BO)  
LIGHTING FORMAT DESIGN STUDIO IMOLA (BO)  
PHOTO R.MONTILLO





## SEZIONI PROFILO FILE H

**SOSPENSIONE - SUSPENSION - SUSPENSIÓN**  
**PARETE - WALL - PARED**

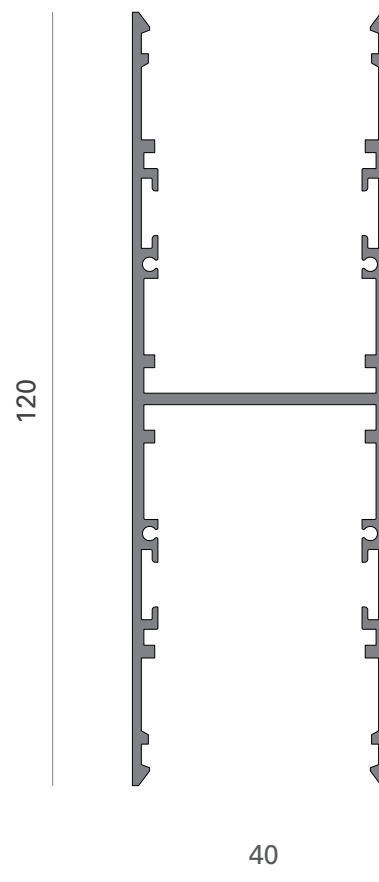

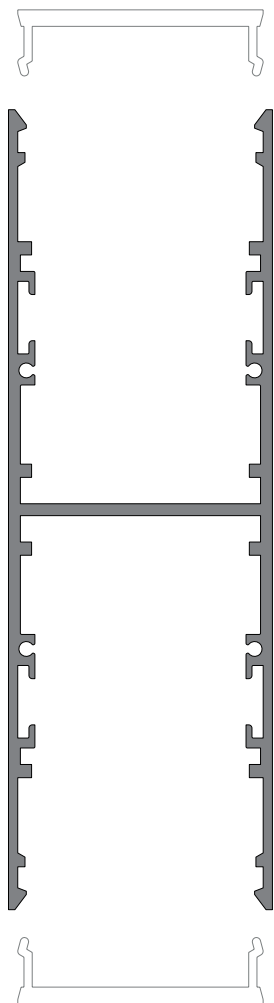

diffusore in policarbonato opalino  
opaline polycarbonate diffuser  
difusor en policarbonato opalino



diffusore microprismatico  
microprismatic diffuser  
difusor microprismatico



riflettore darklight  
darklight grid  
reflector darklight

## FILE H LED SOSPENSIONE BI-EMISSIONE CON DIFFUSORE OPALINO

LED DOUBLE -EMISSION WITH OPALINE DIFFUSER- LED BI-EMISSION CON DIFUSOR OPALINO

	W	K	lm product	lm/Led	CRI	DalIT&D	Lmm	Kg	CODE	Col.
	LINEAR LED 24W/MT 2200LM/MT CRI>80	2x19,2	3000	2208	3696	>80	860	2,50	LTC930	01 02 27 49
		2x19,2	3000	2208	3696	>80	860	2,50	LTC930D	01 02 27 49
		2x25,6	3000	2944	4928	>80	1140	3,30	LTC931	01 02 27 49
		2x25,6	3000	2944	4928	>80	1140	3,30	LTC931D	01 02 27 49
		2x32	3000	3681	6160	>80	1420	4,20	LTC932	01 02 27 49
		2x32	3000	3681	6160	>80	1420	4,20	LTC932D	01 02 27 49
		2x38,4	3000	4417	7392	>80	1700	4,00	LTC933	01 02 27 49
		2x38,4	3000	4417	7392	>80	1700	4,00	LTC933D	01 02 27 49
		2x44,8	3000	5153	8624	>80	1985	4,30	LTC934	01 02 27 49
		2x44,8	3000	5153	8624	>80	1985	4,30	LTC934D	01 02 27 49
		2x51,2	3000	5889	9856	>80	2265	6,50	LTC935	01 02 27 49
		2x51,2	3000	5889	9856	>80	2265	6,50	LTC935D	01 02 27 49
		2x57,6	3000	6625	11088	>80	2545	6,90	LTC936	01 02 27 49
		2x57,6	3000	6625	11088	>80	2545	6,90	LTC936D	01 02 27 49
		2x64	3000	7361	12320	>80	2825	7,20	LTC937	01 02 27 49
		2x64	3000	7361	12320	>80	2825	7,20	LTC937D	01 02 27 49
	50000h Ta 25° L70B10	A+								



Versione 4000 K disponibile a listino. | Version 4000 K available on pricelist. | Versión con 4000K disponible en la lista de precios.

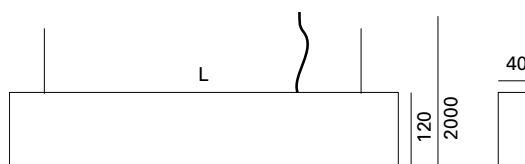

## FILE H LED SOSPENSIONE BI-EMISSIONE CON DIFFUSORE MICROPRISMATICO\*

DOUBLE EMISSION WITH MICROPRISMATIC DIFFUSER - BI-EMISSION CON DIFUSOR MICROPRISMATICO

	W	K	lm product	lm/Led	CRI	DalIT&D	Lmm	Kg	CODE	Col.
	LINEAR LED 24W/MT 2200LM/MT CRI>80	2x19,2	3000	2592	3696	>80	860	2,50	LTC930X	01 02 27 49
		2x19,2	3000	2592	3696	>80	860	2,50	LTC930XD	01 02 27 49
		2x25,6	3000	3456	4928	>80	1140	3,30	LTC931X	01 02 27 49
		2x25,6	3000	3456	4928	>80	1140	3,30	LTC931XD	01 02 27 49
		2x32	3000	4320	6160	>80	1420	4,20	LTC932X	01 02 27 49
		2x32	3000	4320	6160	>80	1420	4,20	LTC932XD	01 02 27 49
		2x38,4	3000	5184	7392	>80	1700	4,00	LTC933X	01 02 27 49
		2x38,4	3000	5184	7392	>80	1700	4,00	LTC933XD	01 02 27 49
		2x44,8	3000	6048	8624	>80	1985	4,30	LTC934X	01 02 27 49
		2x44,8	3000	6048	8624	>80	1985	4,30	LTC934XD	01 02 27 49
		2x51,2	3000	6912	9856	>80	2265	6,50	LTC935X	01 02 27 49
		2x51,2	3000	6912	9856	>80	2265	6,50	LTC935XD	01 02 27 49
		2x57,6	3000	7776	11088	>80	2545	6,90	LTC936X	01 02 27 49
		2x57,6	3000	7776	11088	>80	2545	6,90	LTC936XD	01 02 27 49
		2x64	3000	8640	12320	>80	2825	7,20	LTC937X	01 02 27 49
		2x64	3000	8640	12320	>80	2825	7,20	LTC937XD	01 02 27 49
	50000h Ta 25° L70B10	A+								



PER LA VERSIONE 4000K VEDI CODICI .4 A LISTINO | FOR 4000K VERSION SEE CODE .4 ON PRICELIST | POR LA VERSIÓN 4000K VER CÓDIGO .4 EN LA LISTA DE PRECIOS.

\* DIFFUSORE MICROPRISMATICO A LUMINANZA CONTROLLATA (CONFORME NORMATIVA EN 12464-1) - CONTROLLED LUMINANCE MICROPRISMATIC DIFFUSER (CONFORMS TO STANDARD EN 12464-1) - DIFUSOR MICROPRISMATICO A LUMINANCA CONTROLADA (SEGUN EN 12464-1)

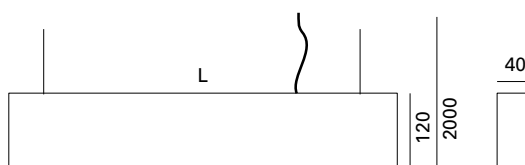

01 - bianco - white - blanco 02 - nero - black - negro 27 - ossidato alluminio - oxidised aluminium - oxidado aluminio 49 - moka - moka - moka

## FILE H SOSPENSIONE BI-EMISSIONE CON DIFFUSORE OPALINO

DOUBLE -EMISSION WITH OPALINE DIFFUSER- BI-EMISSION CON DIFUSOR OPALINO

	W	DaliT&D	Lmm	Kg	CODE	Col.	
	T16						
		1+1x21-39		881	2,80	LT2930	01 02 27 49
		1+1x21-39	x	881	2,80	LT2930D	01 02 27 49
		1+1x28-54		1181	3,60	LT2932	01 02 27 49
		1+1x28-54	x	1181	3,60	LT2932D	01 02 27 49
		1+1x35-49-80		1481	4,20	LT2934	01 02 27 49
		1+1x35-49-80	x	1481	4,20	LT2934D	01 02 27 49
		2+2x21-39		1753	4,80	LT935	01 02 27 49
		2+2x21-39	x	1753	4,80	LT935D	01 02 27 49
		2+2x28-54		2353	6,50	LT2937	01 02 27 49
		2+2x28-54	x	2353	6,50	LT2937D	01 02 27 49
		2+2x35-49		2953	7,20	LT938	01 02 27 49
		2+2x35-49	x	2953	7,20	LT938D	01 02 27 49
		2+2x80		2953	7,20	LT939	01 02 27 49

Su richiesta versioni Emergenza | Emergency version on request | Emergencia ersiones bajo demanda

## FILE H SOSPENSIONE BI-EMISSIONE CON DIFFUSORE MICROPRISMATICO\*

DOUBLE EMISSION WITH MICROPRISMATIC DIFFUSOR - BI-EMISSION CON DIFUSOR MICROPRISMATICO

	W	DaliT&D	Lmm	Kg	CODE	Col.	
	T16						
		1+1x21-39		881	2,80	LT2930X	01 02 27 49
		1+1x21-39	x	881	2,80	LT2930XD	01 02 27 49
		1+1x28-54		1181	3,60	LT2932X	01 02 27 49
		1+1x28-54	x	1181	3,60	LT2932XD	01 02 27 49
		1+1x35-49-80		1481	4,20	LT2934X	01 02 27 49
		1+1x35-49-80	x	1481	4,20	LT2934XD	01 02 27 49
		2+2x21-39		1753	4,80	LT935X	01 02 27 49
		2+2x21-39	x	1753	4,80	LT935XD	01 02 27 49
		2+2x28-54		2353	6,50	LT2937X	01 02 27 49
		2+2x28-54	x	2353	6,50	LT2937XD	01 02 27 49
		2+2x35-49		2953	7,20	LT938X	01 02 27 49
		2+2x35-49	x	2953	7,20	LT938XD	01 02 27 49
		2+2x80		2953	7,20	LT939X	01 02 27 49

\* DIFFUSORE MICROPRISMATICO A LUMINANZA CONTROLLATA (CONFORME NORMATIVA EN 12464-1) - CONTROLLED LUMINANCE MICROPRISMATIC DIFFUSER (CONFORMS TO STANDARD EN 12464-1) - DIFUSOR MICROPRISMATICO A LUMINANCIA CONTROLADA (SEGUN EN 12464-1)

## FILE H SOSPENSIONE BI-EMISSIONE CON DARKLIGHT

DOUBLE EMISSION WITH DARKLIGHT - BI-EMISSION CON DARKLIGHT

	W	DaliT&D	Lmm	Kg	CODE	Col.	
	T16						
		1+1x21-39		881	2,80	LT2930K	01 02 27 49
		1+1x21-39	x	881	2,80	LT2930KD	01 02 27 49
		1+1x28-54		1181	3,60	LT2932K	01 02 27 49
		1+1x28-54	x	1181	3,60	LT2932KD	01 02 27 49
		1+1x35-49-80		1481	4,20	LT2934K	01 02 27 49
		1+1x35-49-80	x	1481	4,20	LT2934KD	01 02 27 49
		2+2x21-39		1753	4,80	LT935K	01 02 27 49
		2+2x21-39	x	1753	4,80	LT935KD	01 02 27 49
		2+2x28-54		2353	6,50	LT2937K	01 02 27 49
		2+2x28-54	x	2353	6,50	LT2937KD	01 02 27 49
		2+2x35-49		2953	7,20	LT938K	01 02 27 49
		2+2x35-49	x	2953	7,20	LT938KD	01 02 27 49
		2+2x80		2953	7,20	LT939K	01 02 27 49

Su richiesta versioni Emergenza | Emergency version on request | Emergencia versiones bajo demanda

\* RIFLETTORE A LUMINANZA CONTROLLATA (CONFORME NORMATIVA EN 12464-1) - CONTROLLED LUMINANCE REFLECTOR (CONFORMS TO STANDARD EN 12464-1) - REFLECTORE A LUMINANCIA CONTROLADA (SEGUN EN 12464-1)

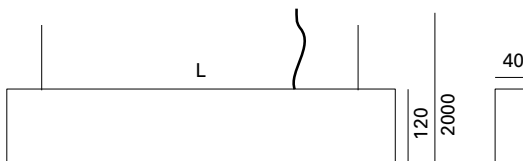

01 - bianco - white - bianco    02 - nero - black - negro    27 - ossidato alluminio - oxidised aluminium - oxidado aluminio    49 - moka - moka - moka



CONSERVATORIO A. BOITO PARMA - ITALY  
PROJECT F. LLI SCORPINETTI  
PHOTO M. FLORES

# FILE H PARETE BI-EMISSIONE CON DIFFUSORE OPALINO

DOUBLE EMISSION WITH OPALINE DIFFUSER- BI-EMISIÓN CON DIFUSOR OPALINO



	W	K	lm product	lm/Led	CRI	DalIT&D	Lmm	Kg	CODE	Col.	
LINEAR LED 24W/MT 2200LM/MT CRI>80	2x12,8	3000	1472	2464	>80		580	1,50	LTC809	01 02 27 49	  
	2x12,8	3000	1472	2464	>80	x	580	1,50	LTC809D	01 02 27 49	
	2x19,2	3000	2208	3696	>80		860	2,50	LTC810	01 02 27 49	
	2x19,2	3000	2208	3696	>80	x	860	2,50	LTC810D	01 02 27 49	
	2x25,6	3000	2944	4928	>80		1140	3,30	LTC811	01 02 27 49	
	2x25,6	3000	2944	4928	>80	x	1140	3,30	LTC811D	01 02 27 49	
	2x32	3000	3681	6160	>80		1420	4,20	LTC812	01 02 27 49	
	2x32	3000	3681	6160	>80	x	1420	4,20	LTC812D	01 02 27 49	
	2x38,4	3000	4417	7392	>80		1700	4,00	LTC813	01 02 27 49	
	2x38,4	3000	4417	7392	>80	x	1700	4,00	LTC813D	01 02 27 49	
	2x44,8	3000	5153	8624	>80		1985	4,30	LTC814	01 02 27 49	
	2x44,8	3000	5153	8624	>80	x	1985	4,30	LTC814D	01 02 27 49	
	2x51,2	3000	5889	9856	>80		2265	6,50	LTC815	01 02 27 49	
	2x51,2	3000	5889	9856	>80	x	2265	6,50	LTC815D	01 02 27 49	
	2x57,6	3000	6625	11088	>80		2545	6,90	LTC816	01 02 27 49	
	2x57,6	3000	6625	11088	>80	x	2545	6,90	LTC816D	01 02 27 49	
	2x64	3000	7361	12320	>80		2825	7,20	LTC817	01 02 27 49	
	2x64	3000	7361	12320	>80	x	2825	7,20	LTC817D	01 02 27 49	

Versione 4000 K disponibile a listino. | Version 4000 K available on pricelist. | Versión con 4000K disponible en la lista de precios.

	W	Lmm	Kg	CODE	Col.	
T16	1+1x14-24	581	1,50	LT2810	01 02 27 49	  
	1+1x21-39	881	2,50	LT2811	01 02 27 49	
	1+1x28-54	1181	3,30	LT2812	01 02 27 49	
	1+1x35-49-80	1481	3,80	LT2813	01 02 27 49	
	2+2x28-54	2353	5,50	LT2814	01 02 27 49	
	2+2x35-49	2953	6,60	LT2816	01 02 27 49	
	2+2x80	2953	6,60	LT2817	01 02 27 49	

Su richiesta versioni Emergenza e Dimmerabile 1-10V | Emergency version on request | Emergencia versiones bajo demanda

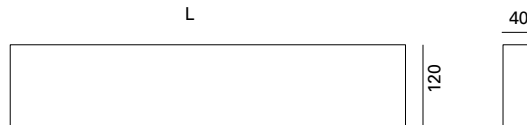

Sistema modulare per illuminazione diretta e indiretta, diffusa e/o d'accento, composto da profili vuoti in estruso di alluminio verniciato o anodizzato 120x40 mm. di lunghezza predefinita o tagliabili a misura, disponibili nelle versioni a parete e sospensione. Da integrare con sorgenti lineari LED, reglette per lampade fluorescenti T16 e moduli binario max 16A 3 accensioni per inserimento di proiettori. Reglette fluorescenti complete di alimentazione elettronica 50/60Hz 230/240V. Reglette LED con driver integrati. Da completare con le testate di chiusura laterali con sistema Light Proof, schermo diffondente in PC opalino bianco o microprismatico (conforme normativa EN 12464-1), profili di chiusura, di lunghezza predefinita o tagliabili a misura, o griglia dark-light in alluminio ad alta specularità e staffe di fissaggio o cavi di sospensione. Grado di protezione IP20 o IP40.

Modular system for direct, diffused and/or accent lighting, consisting of hollow profiles made from 120x40 mm painted or anodised extruded aluminium, with a predefined length or cut to measure, available in the following versions: wall-mounted, suspended. To be integrated with LED linear light sources, battens for T16 and T16 seamless fluorescent lamps and max 16A 3-circuit track modules for inclusion of projectors. Fluorescent battens, complete with 50/60 Hz 230/240 V electronic power supply, LED batten driver included. To be completed with side end caps with Light Proof system, opal white or microprismatic PC diffusing screen (in accordance with EN 12464-1), closing profiles, with a predefined length or cut to measure, or dark-light aluminium grille with high specular qualities and mounting brackets or suspension cables. IP20 or IP40 protection rating.

Sistema modular para la iluminación directa, difusa y/o concentrada. Compuesto de perfil vacío en estruso de aluminio barnizado o anodizado 120x40 mm. de largo predefinida o cortable a medida, disponible en la versiones de pared y suspensión. Preparados para fuentes luminosas lineales LED, regletas para lámparas fluorescentes T16 y rieles binarios máx. 16A 3 encendidos, para la colocación de proyectores. Regletas para lámparas fluorescentes con alimentación electrónica 50/60Hz 230/240V, reglette Led con alimentador incluido. Se complementan con las tapas de cierre laterales con sistema "Light Proof", difusor en PC blanco opal o micro prismático (conforme normativa EN 12464-1), perfil de cierre, de longitud predefinida o cortable a medida, o difusor dark-light en aluminio de gran luminosidad, soporte de fijación o cables de suspensión. Grado de protección IP20 o IP40.



**FILE H SISTEMA**



## PROFILO VUOTO SOSPENSIONE

EMPTY POFILE- PERFL VACIO



Lmm	Kg	CODE	Col.
1000	1.98	LT2310.1000	01 02 27 49
2000	3.95	LT2310.2000	01 02 27 49
3000	5.90	LT2310.3000	01 02 27 49
.....		LT2310.misura*	01 02 27 49

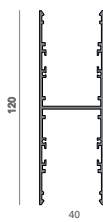

## PROFILO VUOTO SOSPENSIONE X

X-SHAPED EMPTY POFILE- PERFL VACIO X



Dim.	CODE	Col.
600x570	LT2310.X	01 02 27 49

## COPPIA TESTATE

COUPLE OF CLOSURE HEADS- TAPAS FINAL



CODE	Col.
LT2404	01 02 27 49

## PROFILO VUOTO SOSPENSIONE 90°

90°-SHAPED EMPTY POFILE - PERFL VACIO 90



Dim.	CODE	Col.
290x320	LT2310.90	01 02 27 49

## PROFILO VUOTO SOSPENSIONE T

T-SHAPED EMPTY POFILE - PERFL VACIO T



Dim.	CODE	Col.
565x320	LT2310.T	01 02 27 49

\*Tramite questo codice è possibile ordinare il profilo in una lunghezza lineare non standard. Sostituire alla parola "misura" la lunghezza desiderata in mm. Per ordinare un profilo con una o entrambe le estremità tagliate ad angolo 45° aggiungere alla misura la lettera "D" (taglio Destro) o "S" (taglio Sinistro). Seguire istruzioni riportate a pag. 834. Per profili oltre i 3 mt e massimo 6 mt le condizioni di trasporto sono da concordare. | \*Through this code it's possible to order the profile in a not-standard linear length. Replace the word "misura" with the desired length in mm. To order a profile with one or both ends 45° angle-cut add the letter "D" (right cut) or "S" (left cut) to the standard or custom length. follow the instructions on page 834. for lengths over 3 mt. to max. 6 mt. transport conditions to negotiate. | \*el uso de este código, se puede ordenar el perfil en un lineal longitud no estándar. Sustitúyase la palabra "medida" de la longitud in mm. Para pedir un perfil con uno o ambos extremos cortados en un ángulo de 45 ° a añadir a la medida de la letra "D" (derecha cortada) o "S" (izquierda cortada). Siga las instrucciones de la página. 834. Perfiles para más de 3 my 6 m Condiciones máximas de transporte a convenir.

01 - bianco - white - bianco 
  02 - nero - black - negro 
  27 - ossidato alluminio - oxidised aluminium - oxidado aluminio 
  49 - moka - moka - moka

## CAVI SOSPENSIONE IN ACCIAIO

STEEL SUSPENSION CABLE- CABLE SUSPENSION EN ACERO



Lmm	Kg	CODE
2000	0.16	LT2410H
4000	0.32	LT2410H.4000

## KIT ALIMENTAZIONE COMPLETO DI ROSONE

POWER CABLE KIT WITH CEILING CANOPY- KIT ALIMENTACION CON FLORON



Dim.	Lmm	Kg	CODE	Col.
3X1	2000	0.18	LT2411	01
3X1	4000	0.36	LT2411.4000	01
4X1	2000	0.26	LT2412	01
4X1	4000	0.52	LT2412.4000	01
5X1	2000	0.30	LT2412.5	01
5X1	4000	0.60	LT2412.5.4000	01
7X1	2000	0.30	LT2412.7	01
7X1	4000	0.60	LT2412.7.4000	01
9X1	2000	0.30	LT2412.9	01
9X1	4000	0.60	LT2412.9.4000	01

## PROFILO VUOTO PARETE

WALL EMPTY PROFILE- PERFL VACIO



Lmm	Kg	CODE	Col.
1000	1.98	LT2311.1000	01 02 27 49
2000	3.95	LT2311.2000	01 02 27 49
3000	5.90	LT2311.3000	01 02 27 49
.....		LT2311.misura*	01 02 27 49

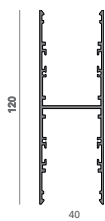

## COPPIA TESTATE

COUPLE OF CLOSURE HEADS- TAPAS FINAL



CODE	Col.
LT2404	01 02 27 49

## DISTANZIALE DA POSIZIONARE TRA PROFILO E PARETE

SINGLE SPACER TO PUT BETWEEN PROFILE AND WALL- ESPACIADOR INDIVIDUAL PARA SER COLOCADO ENTRE EL PERFIL Y LA PARED



CODE  
LTX001

Uno ogni 1/1,5 mt | one every 1/1,5 mt | uno cada 1/1,5 mt

01 - bianco - white - bianco
  02 - nero - black - negro
  27 - ossidato alluminio - oxidised aluminium - oxidado aluminio
  49 - moka - moka - moka

## FILE H REGLETTE LED 24W/MT

24W/MT LED BATTEN- REGLETTE LED 24W/MT

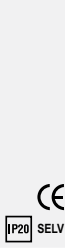
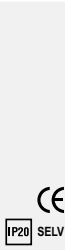
	W	K	lm product	lm/Led	CRI	DaliT&D	Lmm	CODE			
 <p>LINEAR LED 24W/MT 2200lm/MT CRI&gt;80 230V</p> <p>50000h Ta 25° L70B10</p> <p><b>A+</b></p>	12,8	3000	1232	1232	>80		560	RLF3M01			
	12,8	3000	1232	1232	>80	x	560	RLF3M01D			
	19,2	3000	1848	1848	>80		840	RLF3M02			
	19,2	3000	1848	1848	>80	x	840	RLF3M02D			
	25,6	3000	2464	2464	>80		1120	RLF3M03			
	25,6	3000	2464	2464	>80	x	1120	RLF3M03D			
	32	3000	3080	3080	>80		1400	RLF3M04			
	32	3000	3080	3080	>80	x	1400	RLF3M04D			
	38,4	3000	3696	3696	>80		1680	RLF3M05			
	38,4	3000	3696	3696	>80	x	1680	RLF3M05D			
	51,2	3000	4928	4928	>80		2240	RLF3M07			
	51,2	3000	4928	4928	>80	x	2240	RLF3M07D			
	<p>LINEAR LED 24W/MT 2285lm/MT CRI&gt;80</p> <p>50000h Ta 25° L70B10</p>	12,8	4000	1280	1280	>80		560		RLF4M01	
		12,8	4000	1280	1280	>80	x	560		RLF4M01D	
19,2		4000	1920	1920	>80		840	RLF4M02			
19,2		4000	1920	1920	>80	x	840	RLF4M02D			
25,6		4000	2560	2560	>80		1120	RLF4M03			
25,6		4000	2560	2560	>80	x	1120	RLF4M03D			
32		4000	3200	3200	>80		1400	RLF4M04			
32		4000	3200	3200	>80	x	1400	RLF4M04D			
38,4		4000	3840	3840	>80		1680	RLF4M05			
38,4		4000	3840	3840	>80	x	1680	RLF4M05D			
51,2		4000	5120	5120	>80		2240	RLF4M07			
51,2		4000	5120	5120	>80	x	2240	RLF4M07D			

alimentatore incluso | included ballast | con trasformador

## FILE REGLETTE LED 41W/MT



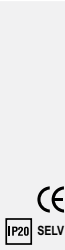
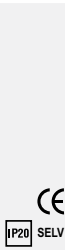

41W/MT LED BATTEN- REGLETTE LED 41W/MT

	W	K	lm product	lm/Led	CRI	DaliT&D	Lmm	CODE			
 <p>LINEAR LED 41W/MT 4640lm/MT CRI90</p> <p><b>A+</b></p>	22,8	3000	2600	2600	90		560	RLF3H01			
	22,8	3000	2600	2600	90	x	560	RLF3H01D			
	34,2	3000	3900	3900	90		840	RLF3H02			
	34,2	3000	3900	3900	90	x	840	RLF3H02D			
	45,6	3000	5200	5200	90		1120	RLF3H03			
	45,6	3000	5200	5200	90	x	1120	RLF3H03D			
	57	3000	6500	6500	90		1400	RLF3H04			
	57	3000	6500	6500	90	x	1400	RLF3H04D			
	68,4	3000	7800	7800	90		1680	RLF3H05			
	68,4	3000	7800	7800	90	x	1680	RLF3H05D			
	91,2	3000	10400	10400	90		2240	RLF3H07			
	91,2	3000	10400	10400	90	x	2240	RLF3H07D			
	<p>LINEAR LED 41W/MT 4820lm/MT CRI90</p>	22,8	4000	2700	2700	90		560		RLF4H01	
		22,8	4000	2700	2700	90	x	560		RLF4H01D	
34,2		4000	4050	4050	90		840	RLF4H02			
34,2		4000	4050	4050	90	x	840	RLF4H02D			
45,6		4000	5400	5400	90		1120	RLF4H03			
45,6		4000	5400	5400	90	x	1120	RLF4H03D			
57		4000	6750	6750	90		1400	RLF4H04			
57		4000	6750	6750	90	x	1400	RLF4H04D			
68,4		4000	8100	8100	90		1680	RLF4H05			
68,4		4000	8100	8100	90	x	1680	RLF4H05D			
91,2		4000	10800	10800	90		2240	RLF4H07			
91,2		4000	10800	10800	90	x	2240	RLF4H07D			

alimentatore incluso | included ballast | con trasformador

# FILE H REGLETTE MONOLAMPADA FLUORESCENTE

SINGLE FLUO BATTEN - REGLETTE MONO FLUO

	T16 G5 230V	W	DaliT&D	Lmm	Kg	CODE	  
		14-24		573	0.40	<b>LT2440.14-24</b>	
		14-24	x	573	0.40	<b>LT40.14-24D</b>	
		21-39		873	0.47	<b>LT2442.21-39</b>	
		21-39	x	873	0.47	<b>LT42.21-39D</b>	
		28-54		1173	0.52	<b>LT2444.28-54</b>	
		28-54	x	1173	0.52	<b>LT44.28-54D</b>	
35-49-80		1473	0.90	<b>LT2446.35-49-80</b>			
35-49-80	x	1473	0.90	<b>LT46.35-80D</b>			

Versione Emergenza su richiesta | emergency version on request | Versione emergenza a demanda.



# PARATIA DIVISORIA SINGOLA MODULO FLUO/BINARIO

INTERMEDIATE SINGLE HEAD FOR FLUO/ TRACK MODULE- TAPA SINGULO INTERMEDIO MODULO FLUO/CARRIL

	CODE	Col.
	<b>LTRP1</b>	<b>01</b>

# STRIP BOBINA DA 5 METRI

STRIP LED 5 METERS ROLL- BOBINA STRIP LED 5 METROS

	LINEAR LED 24V	W/mt	V	Led/mt	lm/mt	K	lm product	lm/W	CRI	IP	A	Lmm	Kg	CODE
		5,5	24	60	270	3000	1350	245	80	20	<b>V.1</b>	5000	0,18	<b>ST05.30.5</b>
9,6	24	120	540	3000	2700	281	80	20	<b>V.1</b>	5000	0,18	<b>ST10.30.5</b>		
11	24	180	1200	3000	6000	545	80	20	<b>V.1</b>	5000	0,18	<b>ST11.30.5</b>		
18	24	168	2200	3000	11000	611	80	20	<b>V.1</b>	5000	0,18	<b>ST21.30.5</b>		

	LINEAR LED IP65 24V	W/mt	V	Led/mt	lm/mt	K	lm product	lm/W	CRI	IP	A	Lmm	Kg	CODE
		9,6	24	120	540	3000	2700	281	80	65	<b>V.1</b>	5000	0,18	<b>ST10.30.5IP</b>
14,4	24	60	900	3000	4500	313	80	65	<b>V.1</b>	5000	0,18	<b>ST15.30.5IP</b>		
19,2	24	240	1080	3000	5400	281	80	65	<b>V.1</b>	5000	0,18	<b>ST20.30.5IP</b>		

# DISSIPATORE PER STRIP LED

HEAT SINCK FOR STRIP LED- DISIPADOR PARA STRIP LED

	Lmm	CODE
	1000	<b>LTC1.1000</b>
	2000	<b>LTC1.2000</b>
	3000	<b>LTC1.3000</b>
	.....	<b>LTC1.misura</b>

\*Tramite questo codice è possibile ordinare il profilo in una lunghezza lineare non standard. Sostituire alla parola "misura" la lunghezza desiderata in mm. Per profili oltre i 3 mt e massimo 6 mt le condizioni di trasporto sono da concordare. | \*Through this code it's possible to order the profile in a not-standard linear length. Replace the word "misura" with the desired length in mm. | \*el uso de este código, se puede ordenar el perfil en un lineal longitud no estándar. Sustitúyase la palabra "medida" de la longitud en mm. Perfiles para más de 3 my 6 m Condiciones máximas de transporte a convenir..

 01 - bianco - white - bianco

 pag.824

 pag.820

## MODULO BINARIO EUROSTANDARD 230V 16A ON/OFF DALI 1-10V

230V TRACK MODULE - MODULO CARRIL

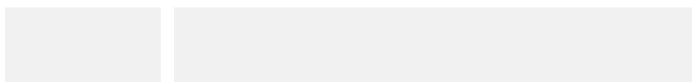

Lmm	Kg	CODE	Col.
1000	0.92	LT24T.1000	01 02
2000	1.83	LT24T.2000	01 02
3000	2.75	LT24T.3000	01 02

Da completare con gli accessori | To complete with accessories | Para completar con accesorios

## ALIMENTAZIONE DI TESTA DX

RIGHT HEAD FEED FOR TRACK SYSTEM- ALIMENTACIÓN DE CABECERA DERECHA TRACK SYSTEM

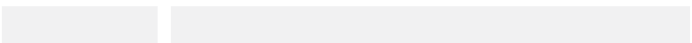
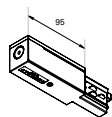

CODE	Col.
LT9020.1	01 02

Possibilità di gestione separata di tre circuiti On/Off oppure di gestione tramite segnale digitale (DALI)

## ALIMENTAZIONE DI TESTA SX

LEFT HEAD FEED FOR TRACK SYSTEM- ALIMENTACIÓN DE CABECERA IZQUIERDA TRACK SYSTEM

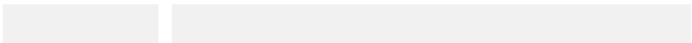
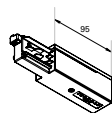

CODE	Col.
LT9021.1	01 02

Possibilità di gestione separata di tre circuiti On/Off oppure di gestione tramite segnale digitale (DALI)

## GIUNTO LINEARE

CONNECTOR FOR TRACK SYSTEM- UNIONES TRACK SYSTEM

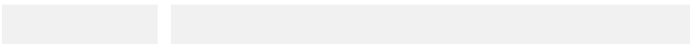

CODE	Col.
LT9023.1	01 02

## TAPPO DI CHIUSURA

BLIND END TRACK SYSTEM- TAPA DE CIERRE TRACK SYSTEM

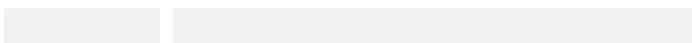

CODE	Col.
LT9033.1	01 02

01 - bianco - white - bianco    02 - nero - black - negro

VEDI PROIETTORI DA BINARIO - SEE PROJECTORS FOR TRACK - VER PROYECTORES POR CARRIL PAG.574

## DIFFUSORE IN POLICARBONATO OPALINO BIANCO

OPAL WHITE POLYCARBONATE DIFFUSER- DIFUSOR OPALINO BLANCO EN POLICARBONATO



Lmm	Kg	CODE
1000	0.16	LT239P1000
2000	0.33	LT239P2000
3000	0.50	LT239P3000
		LT239Pmisura*

## DIFFUSORE IN POLICARBONATO MICROPRISMATICO

MICROPRISMATIC POLYCARBONATE DIFFUSER- DIFUSOR EN POLICARBONATO MICROPRISMATICO



Lmm	Kg	CODE
1000	0.16	LT239X.1000
2000	0.33	LT239X.2000
3000	0.50	LT239X.3000
		LT239X.misura*

## RIFLETTORE DARK-LIGHT

DARK-LIGHT REFLECTOR- REFLECTOR DARK-LIGHT



Lmm	Kg	CODE
573	0.05	LT2397
873	0.08	LT2398
1173	0.11	LT2399
1473	0.14	LT2400

Abbinabile solo a moduli fluorescenti con lampade T16 standard | Suitable just for fluorescent T16 standard | Sólo se pueden combinar para formar las lámparas fluorescentes T16 estándar

## PROFILO DI CHIUSURA IN ESTRUSO DI ALLUMINIO

EXTRUDED ALUMINIUM CLOSING COVER- TAPA EN EXTRUSO DE ALUMINIO



Lmm	CODE	Col.
1000	LT11.1000	01 02 27 49
2000	LT11.2000	01 02 27 49
3000	LT11.3000	01 02 27 49
	LT11.misura*	01 02 27 49

## GIUNTI LINEARI

LINEAR CONNECTORS- CONECTORES LINEARES



Kg	CODE
0.05	LT2406.H

## GIUNTI ANGOLARI COPPIA





ANGLE CONNECTORS COUPLE- CONNECTOR ANGULO PAREJA



CODE
LT2406.H90



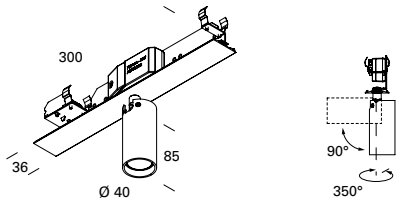

01 - bianco - white - bianco
  02 - nero - black - negro
  27 - ossidato alluminio - oxidised aluminium - oxidado aluminio
  49 - moka - moka - moka

## FARETEN FOCUS 41S

	W	K	lm product	lm/Led	CRI	Dali	△	Dim.	Lmm	H	CODE	Col.	
 <p>LED</p> <p>50000h L90 B10 ta 25°C</p> <p><b>A+</b></p>	5	2700	310	395	95		22°	ø40	300x36	85	<b>FR021.927F 01 02</b> <b>FR021.927FD 01 02</b> <b>FR021.930F 01 02</b> <b>FR021.930FD 01 02</b>	   	
	5	2700	310	395	95	x	22°	ø40	300x36	85			
	5	3000	310	395	95		22°	ø40	300x36	85			
	5	3000	310	395	95	x	22°	ø40	300x36	85			
	5	3000	310	395	95	x	22°	ø40	300x36	85			





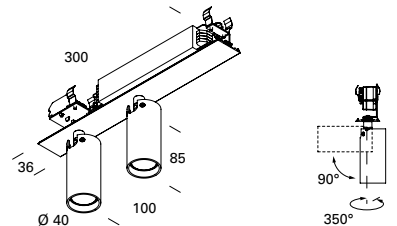

## FARETEN FOCUS 42S

	W	K	lm product	lm/Led	CRI	Dali	△	Dim.	Lmm	H	CODE	Col.	
 <p>LED</p> <p>50000h L90 B10 ta 25°C</p> <p><b>A+</b></p>	2x5	2700	620	790	95		22°	ø40	300x36	85	<b>FR022.927F 01 02</b> <b>FR022.927FD 01 02</b> <b>FR022.930F 01 02</b> <b>FR022.930FD 01 02</b>	   	
	2x5	2700	620	790	95	x	22°	ø40	300x36	85			
	2x5	3000	620	790	95		22°	ø40	300x36	85			
	2x5	3000	620	790	95	x	22°	ø40	300x36	85			
	2x5	3000	620	790	95	x	22°	ø40	300x36	85			



## FARETEN MINISPOT S

	W	K	lm product	lm/Led	CRI	Dali	△	Dim.	Lmm	CODE	Col.	
 <p>LED</p> <p><b>A+</b></p>	5x1,5	2700	432	415	95		15°	ø20	300x36	<b>FR023.927S 01 02</b> <b>FR023.927SD 01 02</b> <b>FR023.930S 01 02</b> <b>FR023.930SD 01 02</b>	   	
	5x1,5	2700	432	415	95	x	15°	ø20	300x36			
	5x1,5	3000	625	600	95		15°	ø20	300x36			
	5x1,5	3000	625	600	95	x	15°	ø20	300x36			
	5x1,5	3000	625	600	95	x	15°	ø20	300x36			

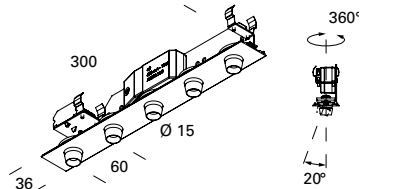

01 - bianco - white - bianco    02 - nero - black - negro





Serie di apparecchi da incasso; incasso a scomparsa totale trimless, soffitto, parete e sospensione per illuminazione diretta diffusa, per sorgenti lineari LED o lampade fluorescenti T16. Alimentazione elettronica integrata 50/60Hz 230/240V. Corpo in estruso di alluminio 75x78 mm. Finitura verniciata o anodizzata. Cornice di battuta super-slim larghezza 5 mm. Completi di staffe di fissaggio al controsoffitto con sistema di regolazione a vite e testate di chiusura laterali e schermo diffondente in policarbonato opalino bianco o microprismatico (conforme normativa EN12464-1) o griglia dark-light in alluminio ad alta specularità. Grado di protezione IP40/IP43. Cassaforma in estruso di alluminio per incasso in laterizio o calcestruzzo disponibile come accessorio.

Series of recessed, trimless recessed, ceiling-mounted, wall-mounted and suspended fixtures for direct diffused lighting. For integrated linear LED sources or for T16 fluorescent lamps. 230/240V 50/60Hz integrated electronic supply. Body in 75x78 mm. extruded aluminium. Painted or anodized finish. Super-slim 5 mm. width edge trim. Complete with false-ceiling/ wall fixing brackets, provided with micro-regulation screw system, side end caps and opal white or microprismatic (conform to EN 12464-1 EU directive) polycarbonate diffuser or high efficiency dark-light aluminium grid. The fixtures become system modules if installed within the Container profile (see Systems section). Protection degree IP40/IP43. Extruded aluminium wallbox for recessed installation in concrete or brick walls, available as an accessory.

Serie de aparatos empotrados, total empotrados, a techo, pared y a suspensión para iluminación directa difuminada, para LED, fluorescentes T16. Alimentación electrónica integrada 50/60Hz 230V/240V. Cuerpo en estruso de aluminio 75x78mm. Acabado barnizado o anodizado. Marco "super-slim" de sólo 5mm. Con soporte de fijación al falso techo con sistema de regulación mediante tornillo y tapas de cierre laterales y difusor en policarbonato opal blanco o microprismático (conforme normativa EN12464-1) o dark light en aluminio de alta luminosidad. Grado de protección IP40/IP43. Caja en estruso de aluminio para la instalación en ladrillo u hormigón disponible como accesorio.

**FILE 2**





TORRE FIERA DISTRICT BOLOGNA - ITALY  
PHOTO M.FLORES





## SEZIONI PROFILO FILE 2

### INCASSO - RECESSED - EMPOTRADO

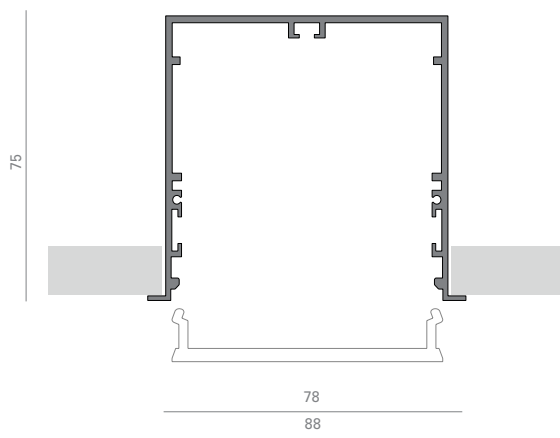

diffusore in policarbonato opalino  
opaline polycarbonate diffuser  
difusor en policarbonato opalino



diffusore microprismatico  
microprismatic diffuser  
difusor microprismatico

### INCASSO RASATO - TRIMLESS RECESSED - TOTAL EMPOTRADO

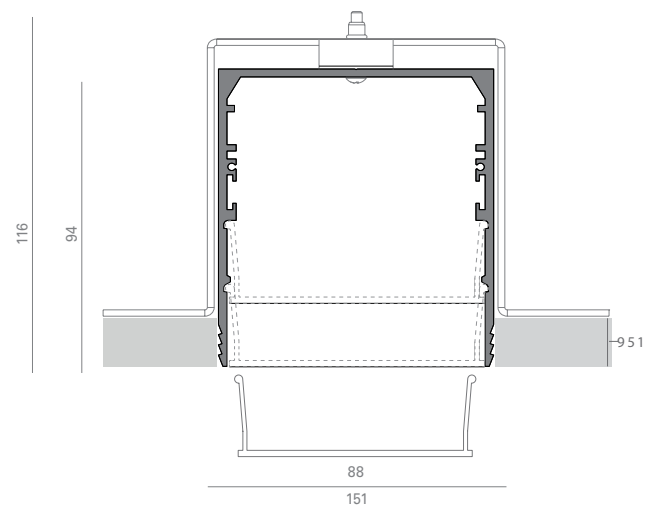

diffusore in policarbonato opalino  
opaline polycarbonate diffuser  
difusor en policarbonato opalino



diffusore microprismatico  
microprismatic diffuser  
difusor microprismatico



diffusore installato a filo  
diffuser installed flush  
difusor instalado al ras

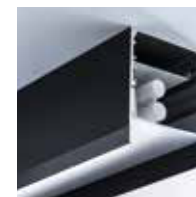

diffusore installato arretrato all'interno del profilo  
diffuser installed backward within the profile  
difusor instalado hacia atrás dentro del perfil.

**SOFFITTO  
SOSPENSIONE  
PARETE**

**CEILING  
SUSPENSION  
WALL**

**TECHO  
SUSPENSIÓN  
PARED**

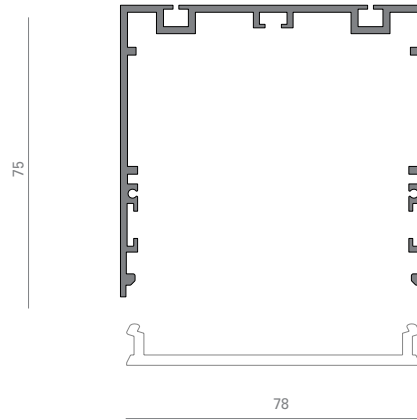

diffusore in policarbonato opalino  
opaline polycarbonate diffuser  
difusor en policarbonato opalino



diffusore microprismatico  
microprismatic diffuser  
difusor microprismatico



riflettore darklight  
darklight grid  
reflector darklight

## FILE 2 INCASSO LED CON DIFFUSORE OPALINO

80xL+2

RECESSED WITH OPAL DIFFUSER- EMPOTRADO CON DIFUSOR OPAL



	W	K	lm product	lm/Led	CRI	DaliT&D	Lmm	Kg	CODE	Col.
LINEAR LED 24W/MT 2200LM/MT CRI=80	19,2	3000	1104	1848	>80		860	2.50	LTC730	01 02 27
	19,2	3000	1104	1848	>80	x	860	2.80	LTC730D	01 02 27
	25,6	3000	1472	2464	>80		1140	3.30	LTC731	01 02 27
	25,6	3000	1472	2464	>80	x	1140	3.80	LTC731D	01 02 27
	32	3000	1840	3080	>80		1420	4.00	LTC732	01 02 27
	32	3000	1840	3080	>80	x	1420	4.50	LTC732D	01 02 27
	38,4	3000	2208	3696	>80		1700	4.70	LTC733	01 02 27
	38,4	3000	2208	3696	>80	x	1700	5.25	LTC733D	01 02 27
	44,8	3000	2576	4312	>80		1985	5.50	LTC734	01 02 27
	44,8	3000	2576	4312	>80	x	1985	5.90	LTC734D	01 02 27
	51,2	3000	2944	4928	>80		2265	6.00	LTC735	01 02 27
	51,2	3000	2944	4928	>80	x	2265	6.40	LTC735D	01 02 27
	57,6	3000	3313	5544	>80		2545	6.40	LTC736	01 02 27
	57,6	3000	3313	5544	>80	x	2545	6.80	LTC736D	01 02 27
	64	3000	3681	6160	>80		2825	6.90	LTC737	01 02 27
	64	3000	3681	6160	>80	x	2825	7.40	LTC737D	01 02 27

50000h Ta 25°  
L70B10 **A+**



	W	K	lm product	lm/Led	CRI	DaliT&D	Lmm	Kg	CODE	Col.
LINEAR LED 41W/MT 4640LM/MT CRI90	34,2	3000	1910	3900	90		860	2.50	LTC730A	01 02 27
	34,2	3000	1910	3900	90	x	860	2.80	LTC730AD	01 02 27
	45,6	3000	2547	5200	90		1140	3.30	LTC731A	01 02 27
	45,6	3000	2547	5200	90	x	1140	3.80	LTC731AD	01 02 27
	57	3000	3184	6500	90		1420	4.00	LTC732A	01 02 27
	57	3000	3184	6500	90	x	1420	4.50	LTC732AD	01 02 27
	68,4	3000	3820	7800	90		1700	4.70	LTC733A	01 02 27
	68,4	3000	3820	7800	90	x	1700	5.25	LTC733AD	01 02 27
	79,8	3000	4457	9100	90		1985	5.50	LTC734A	01 02 27
	79,8	3000	4457	9100	90	x	1985	5.90	LTC734AD	01 02 27
	91,2	3000	5094	10400	90		2265	6.00	LTC735A	01 02 27
	91,2	3000	5094	10400	90	x	2265	6.40	LTC735AD	01 02 27
	102,6	3000	5731	11700	90		2545	6.40	LTC736A	01 02 27
	102,6	3000	5731	11700	90	x	2545	6.80	LTC736AD	01 02 27
	114	3000	6367	13000	90		2825	6.90	LTC737A	01 02 27
	114	3000	6367	13000	90	x	2825	7.40	LTC737AD	01 02 27

**A+**



Su richiesta disponibile la versione 4000K | On request available 4000K version | Versión con 4000K a demanda.

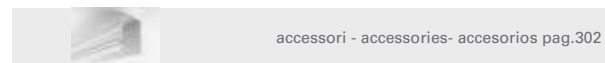
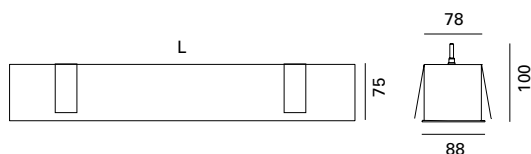

01 - bianco - white - bianco 02 - nero - black - negro 27 - ossidato alluminio - oxidised aluminium - oxidado aluminio



# FILE 2 INCASSO LED IP54 CON DIFFUSORE OPALINO

IP54 RECESSED WITH OPAL DIFFUSER- EMPOTRADO CON DIFUSOR OPAL

80xL+2



	W	K	lm product	lm/Led	CRI	DalIT&D	Lmm	Kg	CODE	Col.
LINEAR LED 24W/MT 2200LM/MT CRI=80	19,2	3000	1104	1848	>80		860	2.50	LTC730IP	01 02 27
	19,2	3000	1104	1848	>80	x	860	2.80	LTC730IPD	01 02 27
	25,6	3000	1472	2464	>80		1140	3.30	LTC731IP	01 02 27
	25,6	3000	1472	2464	>80	x	1140	3.80	LTC731IPD	01 02 27
	32	3000	1840	3080	>80		1420	4.00	LTC732IP	01 02 27
	32	3000	1840	3080	>80	x	1420	4.50	LTC732IPD	01 02 27
	38,4	3000	2208	3696	>80		1700	4.70	LTC733IP	01 02 27
	38,4	3000	2208	3696	>80	x	1700	5.25	LTC733IPD	01 02 27
	44,8	3000	2576	4312	>80		1985	5.50	LTC734IP	01 02 27
	44,8	3000	2576	4312	>80	x	1985	5.90	LTC734IPD	01 02 27
	51,2	3000	2944	4928	>80		2265	6.00	LTC735IP	01 02 27
	51,2	3000	2944	4928	>80	x	2265	6.40	LTC735IPD	01 02 27
	57,6	3000	3313	5544	>80		2545	6.40	LTC736IP	01 02 27
	57,6	3000	3313	5544	>80	x	2545	6.80	LTC736IPD	01 02 27
	64	3000	3681	6160	>80		2825	6.90	LTC737IP	01 02 27
	64	3000	3681	6160	>80	x	2825	7.40	LTC737IPD	01 02 27

50000h Ta 25°  
L70B10 **A+**

CE, IP54, A

	W	K	lm product	lm/Led	CRI	DalIT&D	Lmm	Kg	CODE	Col.
LINEAR LED 41W/MT 4640LM/MT CRI90	34,2	3000	1910	3900	90		860	2.50	LTC730AIP	01 02 27
	34,2	3000	1910	3900	90	x	860	2.80	LTC730AIPD	01 02 27
	45,6	3000	2547	5200	90		1140	3.30	LTC731AIP	01 02 27
	45,6	3000	2547	5200	90	x	1140	3.80	LTC731AIPD	01 02 27
	57	3000	3184	6500	90		1420	4.00	LTC732AIP	01 02 27
	57	3000	3184	6500	90	x	1420	4.50	LTC732AIPD	01 02 27
	68,4	3000	3820	7800	90		1700	4.70	LTC733AIP	01 02 27
	68,4	3000	3820	7800	90	x	1700	5.25	LTC733AIPD	01 02 27
	79,8	3000	4457	9100	90		1985	5.50	LTC734AIP	01 02 27
	79,8	3000	4457	9100	90	x	1985	5.90	LTC734AIPD	01 02 27
	91,2	3000	5094	10400	90		2265	6.00	LTC735AIP	01 02 27
	91,2	3000	5094	10400	90	x	2265	6.40	LTC735AIPD	01 02 27
	102,6	3000	5731	11700	90		2545	6.40	LTC736AIP	01 02 27
	102,6	3000	5731	11700	90	x	2545	6.80	LTC736AIPD	01 02 27
	114	3000	6367	13000	90		2825	6.90	LTC737AIP	01 02 27
	114	3000	6367	13000	90	x	2825	7.40	LTC737AIPD	01 02 27

**A+**

CE, IP54, A

Su richiesta disponibile la versione 4000K | On request available 4000K version | Versión con 4000K a demanda.

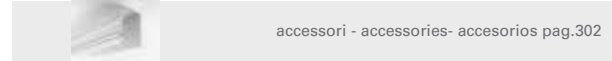
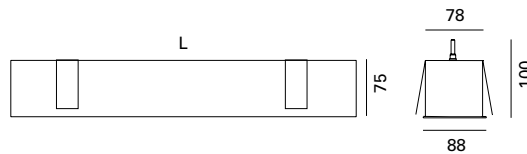

01 - bianco - white - bianco    02 - nero - black - negro    27 - ossidato alluminio - oxidised aluminium - oxidado aluminio

pag.824

## FILE 2 INCASSO MONO FLUO CON DIFFUSORE OPALINO

RECESSED SINGLE LAMP WITH OPAL DIFFUSER - EMPOTRADO MONO FLUO CON DIFUSOR OPAL

 80xL+2



T16	W	Lmm	CODE	Col.
	21-39	877	LT2730	01 02 27
	28-54	1177	LT2732	01 02 27
	35-49-80	1477	LT2734	01 02 27
	1+1x21-39	1752	LTA736	01 02 27
	1+1x28-54	2352	LT2737	01 02 27
	1+1x35-49	2952	LTA738	01 02 27
	1+1x80	2952	LTA739	01 02 27



Su richiesta versioni Emergenza | Emergency versions on request | Versiones de emergencia a demanda

## MONO FLUO OVERLAP LUCE CONTINUA

SINGLE OVERLAP FLUO CONTINUOUS LIGHT- MONO FLUO OVERLAP LUZ CONTINUA

T16	W	Lmm	CODE	Col.
	1+1x21-39	1652	LTA032	01 02 27
	1+1x28-54	2252	LT5034	01 02 27
	1+1x35-49	2852	LTA035	01 02 27
	1+1x80	2852	LTA036	01 02 27



Su richiesta versioni Emergenza | Emergency versions on request | Versiones de emergencia a demanda

## BI FLUO CON DIFFUSORE OPALINO

DOUBLE - LAMP FLUO WITH DIFFUSER- BI FLUO CON DIFUSOR

 80xL+2

T16	W	Lmm	CODE	Col.
	2x21-39	877	LT2742	01 02 27
	2x28-54	1177	LT2744	01 02 27
	2x35-49	1477	LTA745	01 02 27
	2x80	1477	LTA746	01 02 27
	2+2x21-39	1752	LTA748	01 02 27
	2+2x28-54	2352	LT2749	01 02 27
	2+2x35-49	2952	LTA750	01 02 27
	2+2x80	2952	LTA751	01 02 27



Su richiesta versioni Emergenza | Emergency versions on request | Versiones de emergencia a demanda

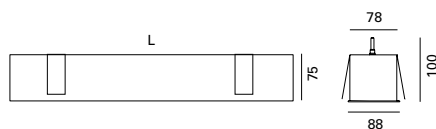

accessori - accessories- accesorios pag.302

# FILE 2 INCASSO LED CON DIFFUSORE MICROPRISMATICO\*

RECESSED WITH MICROPRISMATIC DIFFUSER - EMPOTRADO CON DIFUSOR MICROPRISMATICO

80xL+2

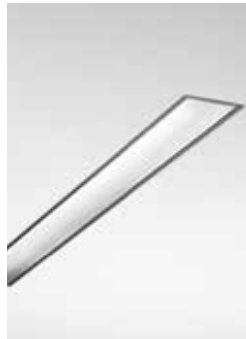

	W	K	lm product	lm/Led	CRI	DaliT&D	Lmm	CODE	Col.
LINEAR LED 24W/MT 2200LM/MT CRI>80	19,2	3000	1296	1848	>80		860	LTC730X	01 02 27
	19,2	3000	1296	1848	>80	x	860	LTC730XD	01 02 27
	25,6	3000	1728	2464	>80		1140	LTC731X	01 02 27
	25,6	3000	1728	2464	>80	x	1140	LTC731XD	01 02 27
	32	3000	2160	3080	>80		1420	LTC732X	01 02 27
	32	3000	2160	3080	>80	x	1420	LTC732XD	01 02 27
	38,4	3000	2592	3696	>80		1700	LTC733X	01 02 27
	38,4	3000	2592	3696	>80	x	1700	LTC733XD	01 02 27
	44,8	3000	3024	4312	>80		1985	LTC734X	01 02 27
	44,8	3000	3024	4312	>80	x	1985	LTC734XD	01 02 27
	51,2	3000	3456	4928	>80		2265	LTC735X	01 02 27
	51,2	3000	3456	4928	>80	x	2265	LTC735XD	01 02 27
	57,6	3000	3888	5544	>80		2545	LTC736X	01 02 27
	57,6	3000	3888	5544	>80	x	2545	LTC736XD	01 02 27
	64	3000	4320	6160	>80		2825	LTC737X	01 02 27
	64	3000	4320	6160	>80	x	2825	LTC737XD	01 02 27

50000h Ta 25°  
L70B10 **A+**



PER LA VERSIONE 4000K VEDI CODICI .4 A LISTINO | FOR 4000K VERSION SEE CODE .4 ON PRICELIST | POR LA VERSIÓN 4000K VER CODIGO .4 EN LA LISTA DE PRECIOS.

	W	K	lm product	lm/Led	CRI	DaliT&D	Lmm	CODE	Col.
LINEAR LED 41W/MT 4640LM/MT CRI90	34,2	3000	2242	3900	90		860	LTC730AX	01 02 27
	34,2	3000	2242	3900	90	x	860	LTC730AXD	01 02 27
	45,6	3000	2989	5200	90		1140	LTC731AX	01 02 27
	45,6	3000	2989	5200	90	x	1140	LTC731AXD	01 02 27
	57	3000	3737	6500	90		1420	LTC732AX	01 02 27
	57	3000	3737	6500	90	x	1420	LTC732AXD	01 02 27
	68,4	3000	4484	7800	90		1700	LTC733AX	01 02 27
	68,4	3000	4484	7800	90	x	1700	LTC733AXD	01 02 27
	79,8	3000	5232	9100	90		1985	LTC734AX	01 02 27
	79,8	3000	5232	9100	90	x	1985	LTC734AXD	01 02 27
	91,2	3000	5979	10400	90		2265	LTC735AX	01 02 27
	91,2	3000	5979	10400	90	x	2265	LTC735AXD	01 02 27
	102,6	3000	6726	11700	90		2545	LTC736AX	01 02 27
	102,6	3000	6726	11700	90	x	2545	LTC736AXD	01 02 27
	114	3000	7474	13000	90		2825	LTC737AX	01 02 27
	114	3000	7474	13000	90	x	2825	LTC737AXD	01 02 27

**A+**



PER LA VERSIONE 4000K VEDI CODICI .4 A LISTINO | FOR 4000K VERSION SEE CODE .4 ON PRICELIST | POR LA VERSIÓN 4000K VER CODIGO .4 EN LA LISTA DE PRECIOS.

\* DIFFUSORE MICROPRISMATICO A LUMINANZA CONTROLLATA (CONFORME NORMATIVA EN 12464-1) - CONTROLLED LUMINANCE MICROPRISMATIC DIFFUSER (CONFORMS TO STANDARD EN 12464-1) - DIFUSOR MICROPRISMATICO A LUMINANCIA CONTROLADA (SEGUN EN 12464-1)

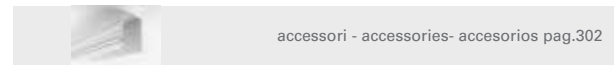
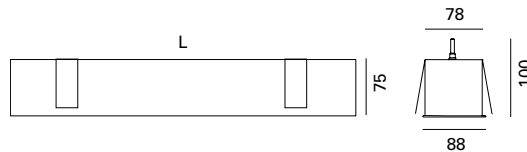

01 - bianco - white - bianco    02 - nero - black - negro    27 - ossidato alluminio - oxidised aluminium - oxidado aluminio

pag.824

## FILE 2 INCASSO MONO FLUO CON DIFFUSORE MICROPRISMATICO\*

SINGLE-LAMP FLUO WITH MICROPRISMATIC DIFFUSER- MONO FLUO CON DIFUSOR MICROPRISMATICO



T16	W	Lmm	CODE	Col.
	21-39	877	LT2730X	01 02 27
	28-54	1177	LT2732X	01 02 27
	35-49-80	1477	LT2734X	01 02 27
	1+1x21-39	1752	LTA736X	01 02 27
	1+1x28-54	2352	LT2737X	01 02 27
	1+1x35-49	2952	LTA738X	01 02 27
	1+1x80	2952	LTA739X	01 02 27

Su richiesta versioni Emergenza | Emergency versions on request | Versiones de emergencia a demanda

## BI FLUO CON DIFFUSORE MICROPRISMATICO\*

DOUBLE-LAMP FLUO WITH MICROPRISMATIC DIFFUSER- BI FLUO CON DIFUSOR MICROPRISMATICO

T16	W	Lmm	CODE	Col.
	2x21-39	877	LT2742X	01 02 27
	2x28-54	1177	LT2744X	01 02 27
	2x35-49	1477	LTA745X	01 02 27
	2x80	1477	LTA746X	01 02 27
	2+2x21-39	1752	LTA748X	01 02 27
	2+2x28-54	2352	LT2749X	01 02 27
	2+2x35-49	2952	LTA750X	01 02 27
	2+2x80	2952	LTA751X	01 02 27

Su richiesta versioni Emergenza | Emergency versions on request | Versiones de emergencia a demanda

\* DIFFUSORE MICROPRISMATICO A LUMINANZA CONTROLLATA (CONFORME NORMATIVA EN 12464-1) - CONTROLLED LUMINANCE MICROPRISMATIC DIFFUSER (CONFORMS TO STANDARD EN 12464-1) - DIFUSOR MICROPRISMATICO A LUMINANCIA CONTROLADA (SEGÚN EN 12464-1)

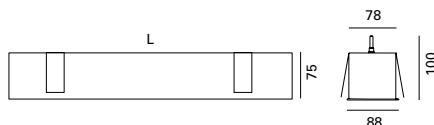

accessori - accessories- accesorios pag.302

## FILE 2 INCASSO MONO FLUO CON DARKLIGHT\*

SINGLE-LAMP FLUO WITH DARKLIGHT- MONO FLUO CON DARKLIGHT



T16	W	Lmm	CODE	Col.	
	21-39	877	LT2730K	01 02 27	
	28-54	1177	LT2732K	01 02 27	
	35-49-80	1477	LT2734K	01 02 27	
	1+1x21-39	1752	LTA736K	01 02 27	
	1+1x28-54	2352	LT2737K	01 02 27	
	1+1x35-49	2952	LTA738K	01 02 27	
	1+1x80	2952	LTA739K	01 02 27	

Su richiesta versioni Emergenza e Dimmerabile 1-10V | Emergency and Dimmable 1-10V versions on request | Versiones de emergencia y Dimmable 1-10V a demanda

## BI FLUO CON DARKLIGHT\*

DOUBLE-LAMP FLUO WITH DARKLIGHT- BI FLUO CON DARKLIGHT

T16	W	Lmm	CODE	Col.	
	2x21-39	877	LT2742K	01 02 27	
	2x28-54	1177	LT2744K	01 02 27	
	2x35-49	1477	LTA745K	01 02 27	
	2x80	1477	LTA746K	01 02 27	
	2+2x21-39	1752	LTA748K	01 02 27	
	2+2x28-54	2352	LT2749K	01 02 27	
	2+2x35-49	2952	LTA750K	01 02 27	
	2+2x80	2952	LTA751K	01 02 27	

Su richiesta versioni Emergenza | Emergency versions on request | Versiones de emergencia a demanda

\* RIFLETTORE A LUMINANZA CONTROLLATA (CONFORME NORMATIVA EN 12464-1) - CONTROLLED LUMINANCE REFLECTOR (CONFORMS TO STANDARD EN 12464-1) - REFLECTORE A LUMINANCIA CONTROLADA (SEGÚN EN 12464-1)

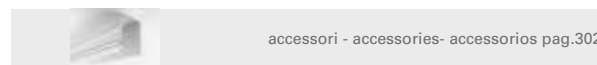
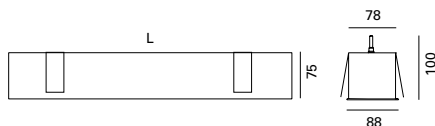

01 - bianco - white - bianco
  02 - nero - black - negro
  27 - ossidato alluminio - oxidised aluminium - oxidado aluminio



GYM FITNESS ONE - AMMAN- JORDAN





## FILE 2 INCASSO RASATO LED CON DIFFUSORE OPALINO

82XL+2

LED TRIMLESS RECESSED WITH DIFFUSER- LED TOTAL EMPOTRADO CON DIFUSOR



	W	K	lm product	lm/Led	CRI	DalIT&D	Lmm	Kg	CODE	Col.
LINEAR LED 24W/MT 2200LM/MT CRI>80	19,2	3000	1104	1848	>80		860	2.50	LTC760	01
	19,2	3000	1104	1848	>80	x	860	2.80	LTC760D	01
	25,6	3000	1472	2464	>80		1140	3.30	LTC761	01
	25,6	3000	1472	2464	>80	x	1140	3.80	LTC761D	01
	32	3000	1840	3080	>80		1420	4.00	LTC762	01
	32	3000	1840	3080	>80	x	1420	4.50	LTC762D	01
	38,4	3000	2208	3696	>80		1700	4.70	LTC763	01
	38,4	3000	2208	3696	>80	x	1700	5.25	LTC763D	01
	44,8	3000	2576	4312	>80		1985	5.50	LTC764	01
	44,8	3000	2576	4312	>80	x	1985	5.90	LTC764D	01
	51,2	3000	2944	4928	>80		2265	6.00	LTC765	01
	51,2	3000	2944	4928	>80	x	2265	6.40	LTC765D	01
	57,6	3000	3313	5544	>80		2545	6.40	LTC766	01
	57,6	3000	3313	5544	>80	x	2545	6.80	LTC766D	01
	64	3000	3681	6160	>80		2825	6.90	LTC767	01
	64	3000	3681	6160	>80	x	2825	7.40	LTC767D	01

50000h Ta 25°  
L70B10

A+



	W	K	lm product	lm/Led	CRI	DalIT&D	Lmm	Kg	CODE	Col.
LINEAR LED 41W/MT 4640LM/MT CRI90	34,2	3000	1910	3900	90		860	2.50	LTC760A	01
	34,2	3000	1910	3900	90	x	860	2.80	LTC760AD	01
	45,6	3000	2547	5200	90		1140	3.30	LTC761A	01
	45,6	3000	2547	5200	90	x	1140	3.80	LTC761AD	01
	57	3000	3184	6500	90		1420	4.00	LTC762A	01
	57	3000	3184	6500	90	x	1420	4.50	LTC762AD	01
	68,4	3000	3820	7800	90		1700	4.70	LTC763A	01
	68,4	3000	3820	7800	90	x	1700	5.25	LTC763AD	01
	79,8	3000	4457	9100	90		1985	5.50	LTC764A	01
	79,8	3000	4457	9100	90	x	1985	5.90	LTC764AD	01
	91,2	3000	5094	10400	90		2265	6.00	LTC765A	01
	91,2	3000	5094	10400	90	x	2265	6.40	LTC765AD	01
	102,6	3000	5731	11700	90		2545	6.40	LTC766A	01
	102,6	3000	5731	11700	90	x	2545	6.80	LTC766AD	01
	114	3000	6367	13000	90		2825	6.90	LTC767A	01
	114	3000	6367	13000	90	x	2825	7.40	LTC767AD	01

A+



Su richiesta disponibile la versione 4000°K | On request available version 4000°K | Versión con 4000°K demanda

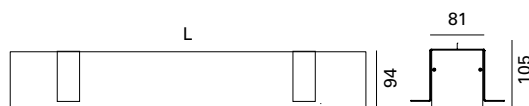



## FILE 2 INCASSO RASATO MONO FLUO CON DIFFUSORE OPALINO

82XL+2

SINGLE-LAMP FLUO WITH DIFFUSER- MONO FLUO CON DIFUSOR



T16	W	Lmm	Kg	CODE	Col.	
	1x21-39	879	2,50	<b>LT2760</b>	<b>01</b>	
	1x28-54	1179	3,30	<b>LT2761</b>	<b>01</b>	
	1x35-49-80	1479	4,00	<b>LT2762</b>	<b>01</b>	

Su richiesta versioni Emergenza | Emergency versions on request | Versiones de emergencia a demanda

## MONO FLUO OVERLAP LUCE CONTINUA CON DIFFUSORE OPALINO

SINGLE-LAMP OVERLAP FLUO CONTINUOUS LIGHT WITH DIFFUSER- MONO FLUO OVERLAP LUZ CONTINUA CON DIFUSOR

T16	W	DaliT&D	Lmm	Kg	CODE	Col.	
	1+1x21-39		1654	4,50	<b>LT2763</b>	<b>01</b>	
	1+1x21-39	x	1654	4,50	<b>LT2763D</b>	<b>01</b>	
	1+1x28-54		2254	5,70	<b>LT2764</b>	<b>01</b>	
	1+1x28-54	x	2254	5,70	<b>LT2764D</b>	<b>01</b>	
	1+1x35-49		2854	6,70	<b>LT2765</b>	<b>01</b>	
	1+1x35-49	x	2854	6,70	<b>LT2765D</b>	<b>01</b>	
	1+1x80		2854	6,70	<b>LT2765</b>	<b>01</b>	
	1+1x80	x	2854	6,70	<b>LT2765D</b>	<b>01</b>	

Su richiesta versioni Emergenza | Emergency versions on request | Versiones de emergencia a demanda

## BI FLUO CON DIFFUSORE OPALINO

DOUBLE-LAMP FLUO WITH DIFFUSER- BI FLUO CON DIFUSOR

T16	W	Lmm	Kg	CODE	Col.	
	2x21-39	879	2,50	<b>LT2768</b>	<b>01</b>	
	2x28-54	1179	3,30	<b>LT2769</b>	<b>01</b>	
	2x35-49	1479	4,00	<b>LT2770</b>	<b>01</b>	
	2x80	1479	4,00	<b>LT2770</b>	<b>01</b>	

Su richiesta versioni Emergenza | Emergency versions on request | Versiones de emergencia a demanda

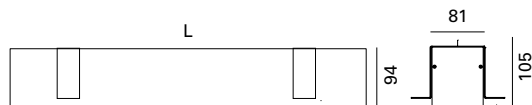

## INCASSO RASATO LED CON DIFFUSORE MICROPRISMATICO\*

82XL+2

TRIMLESS RECESSED LED WITH MICROPRISMATIC DIFFUSER- TOTAL EMPOTRABLE LED CON MICROPRISMATICO



	W	K	Im product	Im/Led	CRI	DaliT&D	Lmm	Kg	CODE	Col.
LINEAR LED 24W/MT 2200Lm/MT CRI>80	19,2	3000	1296	1848	>80		860	2.50	LTC760X	01
	19,2	3000	1296	1848	>80	x	860	2.80	LTC760XD	01
	25,6	3000	1728	2464	>80		1140	3.30	LTC76	01
	25,6	3000	1728	2464	>80	x	1140	3.80	LTC76D	01
	32	3000	2160	3080	>80		1420	4.00	LTC762X	01
	32	3000	2160	3080	>80	x	1420	4.50	LTC762XD	01
	38,4	3000	2592	3696	>80		1700	4.70	LTC763X	01
	38,4	3000	2592	3696	>80	x	1700	5.25	LTC763XD	01
	44,8	3000	3024	4312	>80		1985	5.50	LTC764X	01
	44,8	3000	3024	4312	>80	x	1985	5.90	LTC764XD	01
	51,2	3000	3456	4928	>80		2265	6.00	LTC765X	01
	51,2	3000	3456	4928	>80	x	2265	6.40	LTC765XD	01
	57,6	3000	3888	5544	>80		2545	6.40	LTC766X	01
	57,6	3000	3888	5544	>80	x	2545	6.80	LTC766XD	01
	64	3000	4320	6160	>80		2825	6.90	LTC767X	01
	64	3000	4320	6160	>80	x	2825	7.40	LTC767XD	01

50000h Ta 25°  
L70B10

A+



PER LA VERSIONE 4000K VEDI CODICI .4 A LISTINO | FOR 4000K VERSION SEE CODE .4 ON PRICELIST | POR LA VERSIÓN 4000K VER CODIGO .4 EN LA LISTA DE PRECIOS.

	W	K	Im product	Im/led	CRI	DaliT&D	Lmm	Kg	CODE	Col.
LINEAR LED 41W/MT 4640Lm/MT CRI90	34,2	3000	2242	3900	90		860	2.50	LTC760AX	01
	34,2	3000	2242	3900	90	x	860	2.80	LTC760AXD	01
	45,6	3000	2989	5200	90		1140	3.30	LTC761AX	01
	45,6	3000	2989	5200	90	x	1140	3.80	LTC761AXD	01
	57	3000	3737	6500	90		1420	4.00	LTC762AX	01
	57	3000	3737	6500	90	x	1420	4.50	LTC762AXD	01
	68,4	3000	4484	7800	90		1700	4.70	LTC763AX	01
	68,4	3000	4484	7800	90	x	1700	5.25	LTC763AXD	01
	79,8	3000	5232	9100	90		1985	5.50	LTC764AX	01
	79,8	3000	5232	9100	90	x	1985	5.90	LTC764AXD	01
	91,2	3000	5979	10400	90		2265	6.00	LTC765AX	01
	91,2	3000	5979	10400	90	x	2265	6.40	LTC765AXD	01
	102,6	3000	6726	11700	90		2545	6.40	LTC766AX	01
	102,6	3000	6726	11700	90	x	2545	6.80	LTC766AXD	01
	114	3000	7474	13000	90		2825	6.90	LTC767AX	01
	114	3000	7474	13000	90	x	2825	7.40	LTC767AXD	01

A+



PER LA VERSIONE 4000K VEDI CODICI .4 A LISTINO | FOR 4000K VERSION SEE CODE .4 ON PRICELIST | POR LA VERSIÓN 4000K VER CODIGO .4 EN LA LISTA DE PRECIOS.

\* DIFFUSORE MICROPRISMATICO A LUMINANZA CONTROLLATA (CONFORME NORMATIVA EN 12464-1) - CONTROLLED LUMINANCE MICROPRISMATIC DIFFUSER (CONFORMS TO STANDARD EN 12464-1) - DIFUSOR MICROPRISMATICO A LUMINANCIA CONTROLADA (SEGUN EN 12464-1)

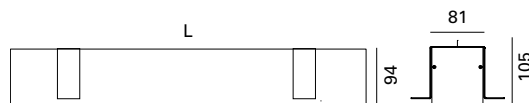

# INCASSO RASATO MONO FLUO CON DIFFUSORE MICROPRISMATICO\*

82XL+2

SINGLE LAMP FLUO WITH MICROPRISMATIC DIFFUSER- MONO FLUO CON DIFUSOR MICROPRISMATICO



T16	W		Lmm	Kg	CODE	Col.	
	1x21-39		879	2,50	LT2760X	01	
	1x28-54		1179	3,30	LT2761X	01	
	1x35-49-80		1479	4,00	LT2762X	01	

Su richiesta versioni Emergenza | Emergency version on request | Versiones de emergencia a demanda

# MONO FLUO OVERLAP LUCE CONTINUA CON MICROPRISMATICO\*

SINGLE-LAMP FLUO OVERLAP CONTINUOUS LIGHT WITH MICROPRISMATIC DIFFUSER- MONO FLUO OVERLAP LUZ CONTINUA CON DIFUSOR MICROPRISMATICO

T16	W	DaliT&D	Lmm	Kg	CODE	Col.	
	1+1x21-39		1654	4,50	LT2763X	01	
	1+1x21-39	x	1654	4,50	LT2763XD	01	
	1+1x28-54		2254	5,70	LT2764X	01	
	1+1x28-54	x	2254	5,70	LT2764XD	01	
	1+1x35-49		2854	6,70	LTA765X	01	
	1+1x35-49	x	2854	6,70	LTA765XD	01	
	1+1x80		2854	6,70	LTB765X	01	
	1+1x80	x	2854	6,70	LTB765XD	01	

Su richiesta versioni Emergenza | Emergency versions on request | Versiones de emergencia a demanda

# BI FLUO CON DIFFUSORE MICROPRISMATICO\*

DOUBLE-LAMP FLUO WITH MICROPRISMATIC DIFFUSER- BI FLUO CON DIFUSOR MICROPRISMATICO

T16	W		Lmm	Kg	CODE	Col.	
	2x21-39		879	2,50	LT2768X	01	
	2x28-54		1179	3,30	LT2769X	01	
	2x35-49		1479	4,00	LTA770X	01	
	2x80		1479	4,00	LTB770X	01	

Su richiesta versioni Emergenza | Emergency versions on request | Versiones de emergencia a demanda

\* DIFFUSORE MICROPRISMATICO A LUMINANZA CONTROLLATA (CONFORME NORMATIVA EN 12464-1) - CONTROLLED LUMINANCE MICROPRISMATIC DIFFUSER (CONFORMS TO STANDARD EN 12464-1) - DIFUSOR MICROPRISMATICO A LUMINANZA CONTROLADA (SEGUN EN 12464-1)

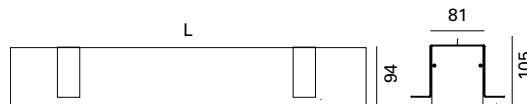



TORRE FIERA DISTRICT BOLOGNA - ITALY  
PHOTO M.FLORES







IDOM HEADQUARTER BILBAO - SPAIN  
PHOTO E. BIDERBOST





## FILE 2 SOFFITTO LED CON DIFFUSORE OPALINO

LED WITH DIFFUSER- LED CON DIFUSOR



	W	K	lm product	lm/Led	CRI	DalIT&D	Lmm	Kg	CODE	Col.	
LINEAR LED 24W/MT 2200LM/MT CRI>80	19,2	3000	1104	1848	>80		860	1,85	LTC530	01 02 27 49	
	19,2	3000	1104	1848	>80	x	860	1,85	LTC530D	01 02 27 49	
	25,6	3000	1472	2464	>80		1140	2,75	LTC531	01 02 27 49	
	25,6	3000	1472	2464	>80	x	1140	2,75	LTC531D	01 02 27 49	
	32	3000	1840	3080	>80		1420	3,20	LTC532	01 02 27 49	
	32	3000	1840	3080	>80	x	1420	3,20	LTC532D	01 02 27 49	
	38,4	3000	2208	3696	>80		1700	3,70	LTC533	01 02 27 49	
	38,4	3000	2208	3696	>80	x	1700	3,70	LTC533D	01 02 27 49	
	44,8	3000	2576	4312	>80		1985	4,40	LTC534	01 02 27 49	
	44,8	3000	2576	4312	>80	x	1985	4,40	LTC534D	01 02 27 49	
	51,2	3000	2944	4928	>80		2265	6,40	LTC535	01 02 27 49	
	51,2	3000	2944	4928	>80	x	2265	6,40	LTC535D	01 02 27 49	
	57,6	3000	3313	5544	>80		2545	6,80	LTC536	01 02 27 49	
	57,6	3000	3313	5544	>80	x	2545	6,80	LTC536D	01 02 27 49	
	64	3000	3681	6160	>80		2825	7,10	LTC537	01 02 27 49	
	64	3000	3681	6160	>80	x	2825	7,10	LTC537D	01 02 27 49	
	50000h Ta 25° L70B10										
		A+								IP40 CE A	

	W	K	lm product	lm/Led	CRI	DalIT&D	Lmm	Kg	CODE	Col.	
LINEAR LED 41W/MT 4640LM/MT CRI90	34,2	3000	1910	3900	90		860	1,85	LTC530A	01 02 27 49	
	34,2	3000	1910	3900	90	x	860	1,85	LTC530AD	01 02 27 49	
	45,6	3000	2547	5200	90		1140	2,75	LTC531A	01 02 27 49	
	45,6	3000	2547	5200	90	x	1140	2,75	LTC531AD	01 02 27 49	
	57	3000	3184	6500	90		1420	3,20	LTC532A	01 02 27 49	
	57	3000	3184	6500	90	x	1420	3,20	LTC532AD	01 02 27 49	
	68,4	3000	3820	7800	90		1700	3,70	LTC533A	01 02 27 49	
	68,4	3000	3820	7800	90	x	1700	3,70	LTC533AD	01 02 27 49	
	79,8	3000	4457	9100	90		1985	4,40	LTC534A	01 02 27 49	
	79,8	3000	4457	9100	90	x	1985	4,40	LTC534AD	01 02 27 49	
	91,2	3000	5094	10400	90		2265	6,40	LTC535A	01 02 27 49	
	91,2	3000	5094	10400	90	x	2265	6,40	LTC535AD	01 02 27 49	
	102,6	3000	5731	11700	90		2545	6,80	LTC536A	01 02 27 49	
	102,6	3000	5731	11700	90	x	2545	6,80	LTC536AD	01 02 27 49	
	114	3000	6367	13000	90		2825	7,10	LTC537A	01 02 27 49	
	114	3000	6367	13000	90	x	2825	7,10	LTC537AD	01 02 27 49	
		A+								IP40 CE A	

Su richiesta disponibile la versione 4000K | On request available 4000K version | Versión con 4000K a demanda.

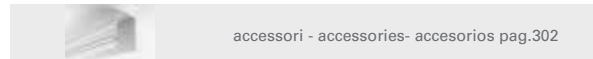
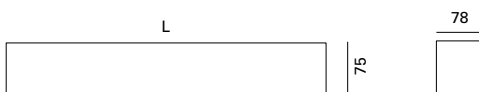

01 - bianco - white - bianco 02 - nero - black - negro 27 - ossidato alluminio - oxidised aluminium - oxidado aluminio 49 - moka - moka - moka



# FILE 2 SOFFITTO LED IP54 CON DIFFUSORE OPALINO

IP54 LED WITH DIFFUSER- LED IP54 CON DIFUSOR



	W	K	lm product	lm/Led	CRI	DaliT&D	Lmm	Kg	CODE	Col.	
LINEAR LED 24W/MT 2200LM/MT CRI>80	19,2	3000	1104	1848	>80		860	1,85	LTC530IP	01 02 27 49	
	19,2	3000	1104	1848	>80	x	860	1,85	LTC530IPD	01 02 27 49	
	25,6	3000	1472	2464	>80		1140	2,75	LTC531IP	01 02 27 49	
	25,6	3000	1472	2464	>80	x	1140	2,75	LTC531IPD	01 02 27 49	
	32	3000	1840	3080	>80		1420	3,20	LTC532IP	01 02 27 49	
	32	3000	1840	3080	>80	x	1420	3,20	LTC532IPD	01 02 27 49	
	38,4	3000	2208	3696	>80		1700	3,70	LTC533IP	01 02 27 49	
	38,4	3000	2208	3696	>80	x	1700	3,70	LTC533IPD	01 02 27 49	
	44,8	3000	2576	4312	>80		1985	4,40	LTC534IP	01 02 27 49	
	44,8	3000	2576	4312	>80	x	1985	4,40	LTC534IPD	01 02 27 49	
	51,2	3000	2944	4928	>80		2265	6,40	LTC535IP	01 02 27 49	
	51,2	3000	2944	4928	>80	x	2265	6,40	LTC535IPD	01 02 27 49	
	57,6	3000	3313	5544	>80		2545	6,80	LTC536IP	01 02 27 49	
	57,6	3000	3313	5544	>80	x	2545	6,80	LTC536IPD	01 02 27 49	
	64	3000	3681	6160	>80		2825	7,10	LTC537IP	01 02 27 49	
	64	3000	3681	6160	>80	x	2825	7,10	LTC537IPD	01 02 27 49	

50000h Ta 25°  
L70B10

A+

	W	K	lm product	lm/Led	CRI	DaliT&D	Lmm	Kg	CODE	Col.	
LINEAR LED 41W/MT 4640LM/MT CRI90	34,2	3000	1910	3900	90		860	1,85	LTC530AIP	01 02 27 49	
	34,2	3000	1910	3900	90	x	860	1,85	LTC530AIPD	01 02 27 49	
	45,6	3000	2547	5200	90		1140	2,75	LTC531AIP	01 02 27 49	
	45,6	3000	2547	5200	90	x	1140	2,75	LTC531AIPD	01 02 27 49	
	57	3000	3184	6500	90		1420	3,20	LTC532AIP	01 02 27 49	
	57	3000	3184	6500	90	x	1420	3,20	LTC532AIPD	01 02 27 49	
	68,4	3000	3820	7800	90		1700	3,70	LTC533AIP	01 02 27 49	
	68,4	3000	3820	7800	90	x	1700	3,70	LTC533AIPD	01 02 27 49	
	79,8	3000	4457	9100	90		1985	4,40	LTC534AIP	01 02 27 49	
	79,8	3000	4457	9100	90	x	1985	4,40	LTC534AIPD	01 02 27 49	
	91,2	3000	5094	10400	90		2265	6,40	LTC535AIP	01 02 27 49	
	91,2	3000	5094	10400	90	x	2265	6,40	LTC535AIPD	01 02 27 49	
	102,6	3000	5731	11700	90		2545	6,80	LTC536AIP	01 02 27 49	
	102,6	3000	5731	11700	90	x	2545	6,80	LTC536AIPD	01 02 27 49	
	114	3000	6367	13000	90		2825	7,10	LTC537AIP	01 02 27 49	
	114	3000	6367	13000	90	x	2825	7,10	LTC537AIPD	01 02 27 49	

A+

Su richiesta disponibile la versione 4000K | On request available 4000K version | Versión con 4000K a demanda.

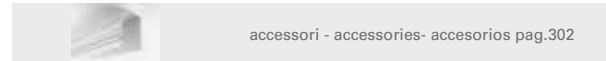

accessori - accessories - accesorios pag.302

01 - bianco - white - bianco 
  02 - nero - black - negro 
  27 - ossidato alluminio - oxidised aluminium - oxidado aluminio 
  49 - moka - moka - moka

pag.824

## FILE 2 SOFFITTO MONO FLUO CON DIFFUSORE OPALINO

MONO FLUO CON DIFFUSORE- SINGLE FLUO WITH DIFFUSER- MONO FLUO CON DIFUSOR

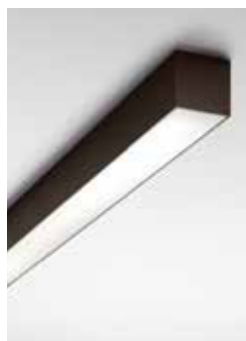

T16	W	Lmm	Kg	CODE	Col.
	21-39	883	1.85	<b>LT2530</b>	<b>01 02 27 49</b>
	28-54	1183	2.75	<b>LT2532</b>	<b>01 02 27 49</b>
	35-49-80	1483	3.20	<b>LT2534</b>	<b>01 02 27 49</b>
	1+1x21-39	1758	3.70	<b>LTA536</b>	<b>01 02 27 49</b>
	1+1x28-54	2358	4.40	<b>LT2537</b>	<b>01 02 27 49</b>
	1+1x35-49	2958	6.40	<b>LTA538</b>	<b>01 02 27 49</b>
	1+1x80	2958	6.40	<b>LTA539</b>	<b>01 02 27 49</b>

Su richiesta versioni Emergenza | Emergency versions on request | Emergencia versiones a demanda



## BI FLUO CON DIFFUSORE OPALINO

BI FLUO CON DIFFUSORE- TWO FLUO WITH DIFFUSER- BI FLUO CON DIFUSOR

T16	W	Lmm	Kg	CODE	Col.
	2x21-39	883	1.85	<b>LT2542</b>	<b>01 02 27 49</b>
	2x28-54	1183	2.70	<b>LT2544</b>	<b>01 02 27 49</b>
	2x35-49	1483	3.40	<b>LTA545</b>	<b>01 02 27 49</b>
	2x80	1483	3.40	<b>LTA546</b>	<b>01 02 27 49</b>
	2+2x21-39	1758	3.70	<b>LTA548</b>	<b>01 02 27 49</b>
	2+2x28-54	2358	5.05	<b>LT2549</b>	<b>01 02 27 49</b>
	2+2x35-49	2954	6.50	<b>LTA550</b>	<b>01 02 27 49</b>
	2+2x80	2958	6.50	<b>LTA551</b>	<b>01 02 27 49</b>

Su richiesta versioni Emergenza | Emergency versions on request | Emergencia versiones a demanda



## MONO FLUO OVERLAP LUCE CONTINUA

MONO FLUO OVERLAP LUCE CONTINUA - SINGLE OVERLAP FLUO CONTINUOUS LIGHT- MONO FLUO OVERLAP LUZ CONTINUA

T16	W	Lmm	Kg	CODE	Col.
	1+1x21-39	1658	3.60	<b>LT2591</b>	<b>01 02 27 49</b>
	1+1x28-54	2258	4.60	<b>LT2592</b>	<b>01 02 27 49</b>
	1+1x35-49-80	2858	5.90	<b>LT2593</b>	<b>01 02 27 49</b>
	1+1x80	2858	5.90	<b>LTA594</b>	<b>01 02 27 49</b>

Su richiesta versioni Emergenza | Emergency versions on request | Emergencia versiones a demanda

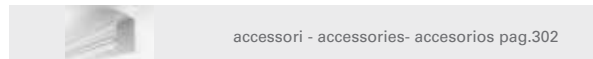
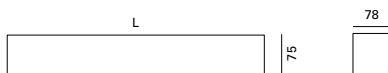

accessori - accessories- accesorios pag.302

 01 - bianco - white - bianco

 02 - nero - black - negro

 27 - ossidato alluminio - oxidised aluminium - oxidado aluminio

 49 - moka - moka - moka

# FILE 2 SOFFITTO LED CON DIFFUSORE MICROPRISMATICO\*

LED WITH MICROPRISMATIC DIFFUSER- LED CON DIFUSOR MICROPRISMATICO



	W	K	lm product	lm/Led	CRI	DalIT&D	Lmm	Kg	CODE	Col.	
LINEAR LED 24W/MT 2200lm/MT CRI=80	19,2	3000	1296	1848	>80		860	1,85	LTC530X	01 02 27 49	
	19,2	3000	1296	1848	>80	x	860	1,85	LTC530XD	01 02 27 49	
	25,6	3000	1728	2464	>80		1140	2,75	LTC531X	01 02 27 49	
	25,6	3000	1728	2464	>80	x	1140	2,75	LTC531XD	01 02 27 49	
	32	3000	2160	3080	>80		1420	3,20	LTC532X	01 02 27 49	
	32	3000	2160	3080	>80	x	1420	3,20	LTC532XD	01 02 27 49	
	38,4	3000	2592	3696	>80		1700	3,70	LTC533X	01 02 27 49	
	38,4	3000	2592	3696	>80	x	1700	3,70	LTC533XD	01 02 27 49	
	44,8	3000	3024	4312	>80		1985	4,40	LTC534X	01 02 27 49	
	44,8	3000	3024	4312	>80	x	1985	4,40	LTC534XD	01 02 27 49	
	51,2	3000	3456	4928	>80		2265	6,40	LTC535X	01 02 27 49	
	51,2	3000	3456	4928	>80	x	2265	6,40	LTC535XD	01 02 27 49	
	57,6	3000	3888	5544	>80		2545	6,80	LTC536X	01 02 27 49	
	57,6	3000	3888	5544	>80	x	2545	6,80	LTC536XD	01 02 27 49	
	64	3000	4320	6160	>80		2825	7,10	LTC537X	01 02 27 49	
	64	3000	4320	6160	>80	x	2825	7,10	LTC537XD	01 02 27 49	

PER LA VERSIONE 4000K VEDI CODICI .4 A LISTINO | FOR 4000K VERSION SEE CODE .4 ON PRICELIST | POR LA VERSIÓN 4000K VER CODIGO .4 EN LA LISTA DE PRECIOS.

	W	K	lm product	lm/Led	CRI	DalIT&D	Lmm	Kg	CODE	Col.	
LINEAR LED 41W/MT 4640lm/MT CRI90	34,2	3000	2242	3900	90		860	1,85	LTC530AX	01 02 27 49	
	34,2	3000	2242	3900	90	x	860	1,85	LTC530AXD	01 02 27 49	
	45,6	3000	2989	5200	90		1140	2,75	LTC531AX	01 02 27 49	
	45,6	3000	2989	5200	90	x	1140	2,75	LTC531AXD	01 02 27 49	
	57	3000	3737	6500	90		1420	3,20	LTC532AX	01 02 27 49	
	57	3000	3737	6500	90	x	1420	3,20	LTC532AXD	01 02 27 49	
	68,4	3000	4484	7800	90		1700	3,70	LTC533AX	01 02 27 49	
	68,4	3000	4484	7800	90	x	1700	3,70	LTC533AXD	01 02 27 49	
	79,8	3000	5232	9100	90		1985	4,40	LTC534AX	01 02 27 49	
	79,8	3000	5232	9100	90	x	1985	4,40	LTC534AXD	01 02 27 49	
	91,2	3000	5979	10400	90		2265	6,40	LTC535AX	01 02 27 49	
	91,2	3000	5979	10400	90	x	2265	6,40	LTC535AXD	01 02 27 49	
	102,6	3000	6726	11700	90		2545	6,80	LTC536AX	01 02 27 49	
	102,6	3000	6726	11700	90	x	2545	6,80	LTC536AXD	01 02 27 49	
	114	3000	7474	13000	90		2825	7,10	LTC537AX	01 02 27 49	
	114	3000	7474	13000	90	x	2825	7,10	LTC537AXD	01 02 27 49	

PER LA VERSIONE 4000K VEDI CODICI .4 A LISTINO | FOR 4000K VERSION SEE CODE .4 ON PRICELIST | POR LA VERSIÓN 4000K VER CODIGO .4 EN LA LISTA DE PRECIOS.

\* DIFFUSORE MICROPRISMATICO A LUMINANZA CONTROLLATA (CONFORME NORMATIVA EN 12464-1) - CONTROLLED LUMINANCE MICROPRISMATIC DIFFUSER (CONFORMS TO STANDARD EN 12464-1) - DIFUSOR MICROPRISMATICO A LUMINANCIA CONTROLADA (SEGUN EN 12464-1)

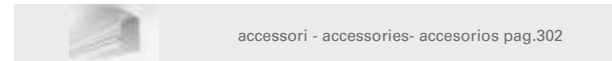

## FILE 2 SOFFITTO MONO FLUO CON DIFFUSORE MICROPRISMATICO\*

SINGLE-LAMP FLUO WITH MICROPRISMATIC DIFFUSER - MONO FLUO CON DIFUSOR MICROPRISMATICO



T16	W	Lmm	Kg	CODE	Col.
	21-39	883	1.85	LT2530X	01 02 27 49
	28-54	1183	2.75	LT2532X	01 02 27 49
	35-49-80	1483	3.20	LT2534X	01 02 27 49
	1+1x21-39	1758	3.70	LTA536X	01 02 27 49
	1+1x28-54	2358	4.40	LT2537X	01 02 27 49
	1+1x35-49	2958	6.40	LTA538X	01 02 27 49
	1+1x80	2958	6.40	LTA539X	01 02 27 49

Su richiesta versioni Emergenza | Emergency and versions on request Dimmable 1-10V | Emergencia versiones a demanda



## BI FLUO CON DIFFUSORE MICROPRISMATICO\*

DOUBLE-LAMP FLUO WITH MICROPRISMATIC DIFFUSER - BI FLUO CON DIFUSOR MICROPRISMATICO

T16	W	Lmm	Kg	CODE	Col.
	2x21-39	883	1.85	LT2542X	01 02 27 49
	2x28-54	1183	2.70	LT2544X	01 02 27 49
	2x35-49	1483	3.40	LTA545X	01 02 27 49
	2x80	1483	3.40	LTA546X	01 02 27 49
	2+2x21-39	1758	3.70	LTA548X	01 02 27 49
	2+2x28-54	2358	5.05	LT2549X	01 02 27 49
	2+2x35-49	2958	6.50	LTA550X	01 02 27 49
	2+2x80	2958	6.50	LTA551X	01 02 27 49

Su richiesta versioni Emergenza | Emergency versions on request | Emergencia versiones a demanda



## MONO FLUO OVERLAP LUCE CONTINUA CON MICROPRISMATICO\*

SINGLE-LAMP OVERLAP FLUO CONTINUOUS LIGHT WITH MICROPRISMATIC DIFFUSER - MONO FLUO OVERLAP LUZ CONTINUA CON DIFUSOR MICROPRISMATICO

T16	W	Lmm	Kg	CODE	Col.
	1+1x21-39	1658	3.60	LT2591X	01 02 27 49
	1+1x28-54	2258	4.60	LT2592X	01 02 27 49
	1+1x35-49	2858	5.90	LT2593X	01 02 27 49
	1+1x80	2858	5.90	LTA594X	01 02 27 49

Su richiesta versioni Emergenza | Emergency versions on request | Emergencia versiones a demanda



\* DIFFUSORE MICROPRISMATICO A LUMINANZA CONTROLLATA (CONFORME NORMATIVA EN 12464-1) - CONTROLLED LUMINANCE MICROPRISMATIC DIFFUSER (CONFORMS TO STANDARD EN 12464-1) - DIFUSOR MICROPRISMATICO A LUMINANCIA CONTROLADA (SEGÚN EN 12464-1)

01 - bianco - white - bianco 
  02 - nero - black - negro 
  27 - ossidato alluminio - oxidised aluminium - oxidado aluminio 
  49 - moka - moka - moka

## FILE 2 SOFFITTO MONO FLUO CON DARKLIGHT\*

SINGLE-LAMP FLUO WITH DARKLIGHT- MONO MONO CON DARKLIGHT



T16	W	Lmm	Kg	CODE	Col.
	21-39	883	1.85	<b>LT2530K</b>	<b>01 02 27 49</b>
	28-54	1183	2.75	<b>LT2532K</b>	<b>01 02 27 49</b>
	35-49-80	1483	3.20	<b>LT2534K</b>	<b>01 02 27 49</b>
	1+1x21-39	1758	3.70	<b>LTA536K</b>	<b>01 02 27 49</b>
	1+1x28-54	2358	4.40	<b>LT2537K</b>	<b>01 02 27 49</b>
	1+1x35-49	2958	6.40	<b>LTA538K</b>	<b>01 02 27 49</b>
	1+1x80	2958	6.40	<b>LTA539K</b>	<b>01 02 27 49</b>

Su richiesta versioni Emergenza | Emergency versions on request | Emergencia versiones a demanda

## BI FLUO CON DARKLIGHT\*

DOUBLE-LAMP FLUO WITH DARKLIGHT- BI FLUO CON DARK-LIGHT

T16	W	Lmm	Kg	CODE	Col.
	2x21-39	883	1.85	<b>LT2542K</b>	<b>01 02 27 49</b>
	2x28-54	1183	2.70	<b>LT2544K</b>	<b>01 02 27 49</b>
	2x35-49	1483	3.40	<b>LTA545K</b>	<b>01 02 27 49</b>
	2x80	1483	3.40	<b>LTA546K</b>	<b>01 02 27 49</b>
	2+2x21-39	1758	3.70	<b>LTA548K</b>	<b>01 02 27 49</b>
	2+2x28-54	2358	5.05	<b>LT2549K</b>	<b>01 02 27 49</b>
	2+2x35-49	2958	6.50	<b>LTA550K</b>	<b>01 02 27 49</b>
	2+2x80	2958	6.50	<b>LTA551K</b>	<b>01 02 27 49</b>

Su richiesta versioni Emergenza | Emergency versions on request | Emergencia versiones a demanda

\* RIFLETTORE A LUMINANZA CONTROLLATA (CONFORME NORMATIVA EN 12464-1) - CONTROLLED LUMINANCE REFLECTOR (CONFORMS TO STANDARD EN 12464-1) - REFLECTORE A LUMINANCIA CONTROLADA (SEGUN EN 12464-1)



01 - bianco - white - bianco
  02 - nero - black - negro
  27 - ossidato alluminio - oxidised aluminium - oxidado aluminio
  49 - moka - moka - moka



IDOM HEADQUARTER BILBAO - SPAIN  
PHOTO E. BIDERBOST







TABAKALERA - CENTRO INTERNACIONAL DE CULTURA CONTEMPORÁNEA - SPAIN  
LIGHT DESIGN TAO ILLUMINACION











## FILE 2 SOSPENSIONE LED CON DIFFUSORE OPALINO

LED LAMP WITH DIFFUSER - LED CON DIFUSOR



	W	K	lm product	lm/Led	CRI	DaliT&D	Lmm	Kg	CODE	Col.	
LINEAR LED 24W/MT 2200LM/MT CRI>80	25,6	3000	1472	2464	>80		1140	2,75	LTC555	01 02 27 49	
	25,6	3000	1472	2464	>80	x	1140	2,75	LTC555D	01 02 27 49	
	32	3000	1840	3080	>80		1420	3,20	LTC556	01 02 27 49	
	32	3000	1840	3080	>80	x	1420	3,20	LTC556D	01 02 27 49	
	38,4	3000	2208	3696	>80		1700	3,70	LTC557	01 02 27 49	
	38,4	3000	2208	3696	>80	x	1700	3,70	LTC557D	01 02 27 49	
	44,8	3000	2576	4312	>80		1985	4,40	LTC558	01 02 27 49	
	44,8	3000	2576	4312	>80	x	1985	4,40	LTC558D	01 02 27 49	
	51,2	3000	2944	4928	>80		2265	6,40	LTC559	01 02 27 49	
	51,2	3000	2944	4928	>80	x	2265	6,40	LTC559D	01 02 27 49	
	57,6	3000	3313	5544	>80		2545	6,80	LTC560	01 02 27 49	
	57,6	3000	3313	5544	>80	x	2545	6,80	LTC560D	01 02 27 49	
	64	3000	3681	6160	>80		2825	7,10	LTC561	01 02 27 49	
	64	3000	3681	6160	>80	x	2825	7,10	LTC561D	01 02 27 49	
	50000h Ta 25° L70B10										

	W	K	lm product	lm/Led	CRI	DaliT&D	Lmm	Kg	CODE	Col.
LINEAR LED 41W/MT 4640LM/MT CRI90	45,6	3000	2547	5200	90		1140	2,75	LTC555A	01 02 27 49
	45,6	3000	2547	5200	90	x	1140	2,75	LTC555AD	01 02 27 49
	57	3000	3184	6500	90		1420	3,20	LTC556A	01 02 27 49
	57	3000	3184	6500	90	x	1420	3,20	LTC556AD	01 02 27 49
	68,4	3000	3820	7800	90		1700	3,70	LTC557A	01 02 27 49
	68,4	3000	3820	7800	90	x	1700	3,70	LTC557AD	01 02 27 49
	79,8	3000	4457	9100	90		1985	4,40	LTC558A	01 02 27 49
	79,8	3000	4457	9100	90	x	1985	4,40	LTC558AD	01 02 27 49
	91,2	3000	5094	10400	90		2265	6,40	LTC559A	01 02 27 49
	91,2	3000	5094	10400	90	x	2265	6,40	LTC559AD	01 02 27 49
	102,6	3000	5731	11700	90		2545	6,80	LTC560A	01 02 27 49
	102,6	3000	5731	11700	90	x	2545	6,80	LTC560AD	01 02 27 49
	114	3000	6367	13000	90		2825	7,10	LTC561A	01 02 27 49
	114	3000	6367	13000	90	x	2825	7,10	LTC561AD	01 02 27 49

Su richiesta disponibile la versione 4000°K | On request available version 4000°K | Versión con 4000°K demanda

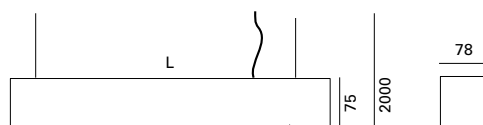

## FILE 2 SOSPENSIONE MONO FLUO CON DIFFUSORE OPALINO

SINGLE-LAMP FLUO WITH DIFFUSER- MONO FLUO CON DIFUSOR



T16	W	DaliT&D	Lmm	Kg	CODE	Col.
	28-54		1183	2,75	<b>LT2556</b>	<b>01 02 27 49</b>
	35-49-80		1483	3,20	<b>LT2558</b>	<b>01 02 27 49</b>
	1+1x21-39		1758	3,70	<b>LTA560</b>	<b>01 02 27 49</b>
	1+1x21-39	x	1758	3,70	<b>LTA560D</b>	<b>01 02 27 49</b>
	1+1x28-54		2358	4,50	<b>LT2561</b>	<b>01 02 27 49</b>
	1+1x28-54	x	2358	4,50	<b>LT2561D</b>	<b>01 02 27 49</b>
	1+1x35-49		2958	5,70	<b>LTA562</b>	<b>01 02 27 49</b>
	1+1x35-49	x	2958	5,70	<b>LTA562D</b>	<b>01 02 27 49</b>
	1+1x80		2958	6,70	<b>LTA563</b>	<b>01 02 27 49</b>
	1+1x80	x	2958	6,70	<b>LTA563D</b>	<b>01 02 27 49</b>

Su richiesta versioni Emergenza | Emergency versions on request | Emergencia versiones bajo demanda



## BI FLUO CON DIFFUSORE OPALINO

DOUBLE-LAMP FLUO WITH DIFFUSER- BI FLUO CON DIFUSOR

T16	W	DaliT&D	Lmm	Kg	CODE	Col.
	2x21-39		883	1,85	<b>LT2566</b>	<b>01 02 27 49</b>
	2x28-54		1183	2,75	<b>LT2568</b>	<b>01 02 27 49</b>
	2x35-49		1483	3,20	<b>LTA569</b>	<b>01 02 27 49</b>
	2x35-49	x	1483	3,20	<b>LTA569D</b>	<b>01 02 27 49</b>
	2x80		1483	3,70	<b>LTA570</b>	<b>01 02 27 49</b>
	2+2x21-39		1758	3,70	<b>LTA572</b>	<b>01 02 27 49</b>
	2+2x21-39	x	1758	4,50	<b>LTA572D</b>	<b>01 02 27 49</b>
	2+2x28-54		2358	4,50	<b>LT2573</b>	<b>01 02 27 49</b>
	2+2x28-54	x	2358	5,70	<b>LT2573D</b>	<b>01 02 27 49</b>
	2+2x35-49		2958	5,70	<b>LTA574</b>	<b>01 02 27 49</b>
	2+2x35-49	x	2958	6,70	<b>LTA574D</b>	<b>01 02 27 49</b>
	2+2x80		2958	6,70	<b>LTA575</b>	<b>01 02 27 49</b>

Su richiesta versioni Emergenza | Emergency versions on request | Emergencia versiones bajo demanda

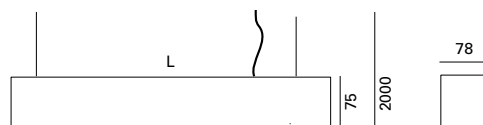

01 - bianco - white - bianco
  02 - nero - black - negro
  27 - ossidato alluminio - oxidised aluminium - oxidado aluminio
  49 - moka - moka - moka

## FILE 2 SOSPENSIONE LED CON DIFFUSORE MICROPRISMATICO\*

LED WITH MICROPRISMATIC DIFFUSER - LED CON DIFUSOR MICROPRISMATICO



	W	K	lm product	lm/Led	CRI	DalIT&D	Lmm	Kg	CODE	Col.
LINEAR LED 24W/MT 2200 LM/MT CRI>80	25,6	3000	1728	2464	>80		1140	2,75	LTC555X	01 02 27 49
	25,6	3000	1728	2464	>80	x	1140	2,75	LTC555XD	01 02 27 49
	32	3000	2160	3080	>80		1420	3,20	LTC556X	01 02 27 49
	32	3000	2160	3080	>80	x	1420	3,20	LTC556XD	01 02 27 49
	38,4	3000	2592	3696	>80		1700	3,70	LTC557X	01 02 27 49
	38,4	3000	2592	3696	>80	x	1700	3,70	LTC557XD	01 02 27 49
	44,8	3000	3024	4312	>80		1985	4,40	LTC558X	01 02 27 49
	44,8	3000	3024	4312	>80	x	1985	4,40	LTC558XD	01 02 27 49
	51,2	3000	3456	4928	>80		2265	6,40	LTC559X	01 02 27 49
	51,2	3000	3456	4928	>80	x	2265	6,40	LTC559XD	01 02 27 49
50000h Ta 25° L70B10	57,6	3000	3888	5544	>80		2545	6,80	LTC560X	01 02 27 49
	57,6	3000	3888	5544	>80	x	2545	6,80	LTC560XD	01 02 27 49
	64	3000	4320	6160	>80		2825	7,10	LTC561X	01 02 27 49
	64	3000	4320	6160	>80	x	2825	7,10	LTC561XD	01 02 27 49

PER LA VERSIONE 4000K VEDI CODICI .4 A LISTINO | FOR 4000K VERSION SEE CODE .4 ON PRICELIST | POR LA VERSIÓN 4000K VER CODIGO .4 EN LA LISTA DE PRECIOS.

	W	K	lm product	lm/Led	CRI	DalIT&D	Lmm	Kg	CODE	Col.
LINEAR LED 41W/MT 4640 LM/MT CRI90	45,6	3000	2989	5200	90		1140	2,75	LTC555AX	01 02 27 49
	45,6	3000	2989	5200	90	x	1140	2,75	LTC555AXD	01 02 27 49
	57	3000	3737	6500	90		1420	3,20	LTC556AX	01 02 27 49
	57	3000	3737	6500	90	x	1420	3,20	LTC556AXD	01 02 27 49
	68,4	3000	4484	7800	90		1700	3,70	LTC557AX	01 02 27 49
	68,4	3000	4484	7800	90	x	1700	3,70	LTC557AXD	01 02 27 49
	79,8	3000	5232	9100	90		1985	4,40	LTC558AX	01 02 27 49
	79,8	3000	5232	9100	90	x	1985	4,40	LTC558AXD	01 02 27 49
	91,2	3000	5979	10400	90		2265	6,40	LTC559AX	01 02 27 49
	91,2	3000	5979	10400	90	x	2265	6,40	LTC559AXD	01 02 27 49
	102,6	3000	6726	11700	90		2545	6,80	LTC560AX	01 02 27 49
	102,6	3000	6726	11700	90	x	2545	6,80	LTC560AXD	01 02 27 49
	114	3000	7474	13000	90		2825	7,10	LTC561AX	01 02 27 49
	114	3000	7474	13000	90	x	2825	7,10	LTC561AXD	01 02 27 49

PER LA VERSIONE 4000K VEDI CODICI .4 A LISTINO | FOR 4000K VERSION SEE CODE .4 ON PRICELIST | POR LA VERSIÓN 4000K VER CODIGO .4 EN LA LISTA DE PRECIOS.

\* DIFFUSORE MICROPRISMATICO A LUMINANZA CONTROLLATA (CONFORME NORMATIVA EN 12464-1) - CONTROLLED LUMINANCE MICROPRISMATIC DIFFUSER (CONFORMS TO STANDARD EN 12464-1) - DIFUSOR MICROPRISMATICO A LUMINANCIA CONTROLADA (SEGUN EN 12464-1)

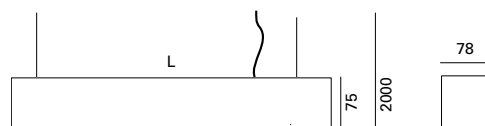

## FILE 2 SOSPENSIONE MONO FLUO CON DIFFUSORE MICROPRISMATICO\*

SINGLE-LAMP FLUO WITH MICROPRISMATIC DIFFUSER- MONO FLUO CON DIFUSOR MICROPRISMATICO



T16	W	DalIT&D	Lmm	Kg	CODE	Col.
	28-54		1183	2,75	LT2556X	01 02 27 49
	35-49-80		1483	3,20	LT2558X	01 02 27 49
	1+1x21-39		1758	3,70	LTA560X	01 02 27 49
	1+1x21-39	x	1758	3,70	LTA560XD	01 02 27 49
	1+1x28-54		2358	5,10	LT2561X	01 02 27 49
	1+1x28-54	x	2358	5,10	LT2561XD	01 02 27 49
	1+1x35-49		2958	6,70	LTA562X	01 02 27 49
	1+1x35-49	x	2958	6,70	LTA562XD	01 02 27 49
	1+1x80		2958	6,70	LTA563X	01 02 27 49
	1+1x80	x	2958	6,70	LTA563XD	01 02 27 49

Su richiesta versioni Emergenza | Emergency versions on request | Emergencia versiones bajo demanda



## BI FLUO CON DIFFUSORE MICROPRISMATICO\*

DOUBLE-LAMP FLUO WITH MICROPRISMATIC DIFFUSER- BI FLUO CON DIFUSOR MICROPRISMATICO

T16	W	DalIT&D	Lmm	Kg	CODE	Col.
	2x21-39		883	1,85	LT2566X	01 02 27 49
	2x28-54		1183	2,75	LT2568X	01 02 27 49
	2x35-49		1483	3,20	LTA569X	01 02 27 49
	2x35-49	x	1483	3,70	LTA569XD	01 02 27 49
	2x80		1483	3,70	LTA570X	01 02 27 49
	2+2x21-39		1758	5,10	LTA572X	01 02 27 49
	2+2x21-39	x	1758	5,10	LTA572XD	01 02 27 49
	2+2x28-54		2358	6,70	LT2573X	01 02 27 49
	2+2x28-54	x	2358	6,70	LT2573XD	01 02 27 49
	2+2x35-49		2958	6,70	LTA574X	01 02 27 49
	2+2x35-49	x	2958	6,70	LTA574XD	01 02 27 49
	2+2x80		2958	5,80	LTA575X	01 02 27 49

Su richiesta versioni Emergenza | Emergency versions on request | Emergencia versiones bajo demanda



\* DIFFUSORE MICROPRISMATICO A LUMINANZA CONTROLLATA (CONFORME NORMATIVA EN 12464-1) - CONTROLLED LUMINANCE MICROPRISMATIC DIFFUSER (CONFORMS TO STANDARD EN 12464-1) - DIFUSOR MICROPRISMATICO A LUMINANCIA CONTROLADA (SEGUN EN 12464-1)

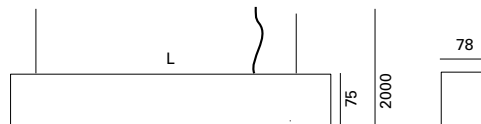

01 - bianco - white - bianco 02 - nero - black - negro 27 - ossidato alluminio - oxidised aluminium - oxidado aluminio

49 - moka - moka - moka

pag.824

## FILE 2 SOSPENSIONE MONO FLUO CON DARKLIGHT\*

MONO FLUO CON DARKLIGHT- MONO LAMP WITH DARK-LIGHT REFLECTOR- MONO LAMPARA CON REFLECTOR DARK-LIGHT



T16	W	DaliT&D	Lmm	Kg	CODE	Col.
	28-54		1183	2,75	LT2556K	01 02 27 49
	35-49-80		1483	3,20	LT2558K	01 02 27 49
	1+1x21-39		1758	3,70	LTA560K	01 02 27 49
	1+1x21-39	x	1758	3,70	LTA560KD	01 02 27 49
	1+1x28-54		2358	5,10	LT2561K	01 02 27 49
	1+1x28-54	x	2358	5,10	LT2561KD	01 02 27 49
	1+1x35-49		2958	5,80	LTA562K	01 02 27 49
	1+1x35-49	x	2958	5,80	LTA562KD	01 02 27 49
	1+1x80		2958	5,80	LTA563K	01 02 27 49
	1+1x80	x	2958	5,80	LTA563KD	01 02 27 49

Su richiesta versioni Emergenza | Emergency versions on request | Emergencia versiones bajo demanda



## BI FLUO CON DARKLIGHT\*

BI FLUO CON DARKLIGHT- DOUBLE FLUO WITH DARKLIGHT- BI FLUO CON DARKLIGHT

T16	W	DaliT&D	Lmm	Kg	CODE	Col.
	2x21-39		883	1,85	LT2566K	01 02 27 49
	2x28-54		1183	2,75	LT2568K	01 02 27 49
	2x35-49		1483	3,70	LTA569K	01 02 27 49
	2x35-49	x	1483	3,70	LTA569KD	01 02 27 49
	2x80		1483	3,70	LTA570K	01 02 27 49
	2+2x21-39		1758	4,50	LTA572K	01 02 27 49
	2+2x21-39	x	1758	4,50	LTA572KD	01 02 27 49
	2+2x28-54		2358	5,10	LT2573K	01 02 27 49
	2+2x28-54	x	2358	5,10	LT2573KD	01 02 27 49
	2+2x35-49		2958	5,80	LTA574K	01 02 27 49
	2+2x35-49	x	2958	5,80	LTA574KD	01 02 27 49
	2+2x80		2958	5,80	LTA575K	01 02 27 49

Su richiesta versioni Emergenza | Emergency versions on request | Emergencia versiones bajo demanda



\* RIFLETTORE A LUMINANZA CONTROLLATA (CONFORME NORMATIVA EN 12464-1) - CONTROLLED LUMINANCE REFLECTOR (CONFORMS TO STANDARD EN 12464-1) - REFLECTORE A LUMINANCIA CONTROLADA (SEGÚN EN 12464-1)

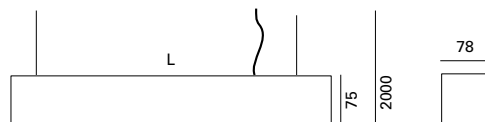

01 - bianco - white - blanco 02 - nero - black - negro 27 - ossidato alluminio - oxidised aluminium - oxidado aluminio 49 - moka - moka - moka





TOOLBOX TORINO - ITALY  
PROJECT ARCH. C. TIAZZOLDI  
PHOTO S. PELLION DA PERSANO

---



**FILE 2 PARETE**



## FILE 2 PARETE LED CON DIFFUSORE OPALINO

LED WITH DIFFUSER- LED CON DIFUSOR



	W	K	Im product	Im/Led	CRI	DaliT&D	Lmm	Kg	CODE	Col.	
LINEAR LED 24W/MT 2200LM/MT CRI>80	19,2	3000	1104	1848	>80		860	1,85	LTC5A1	01 02 27 49	  
	19,2	3000	1104	1848	>80	x	860	1,85	LTC5A1D	01 02 27 49	
	25,6	3000	1472	2464	>80		1140	2,75	LTC5A2	01 02 27 49	
	25,6	3000	1472	2464	>80	x	1140	2,75	LTC5A2D	01 02 27 49	
	32	3000	1840	3080	>80		1420	3,20	LTC5A3	01 02 27 49	
	32	3000	1840	3080	>80	x	1420	3,20	LTC5A3D	01 02 27 49	
	38,4	3000	2208	3696	>80		1700	3,70	LTC5A4	01 02 27 49	
	38,4	3000	2208	3696	>80	x	1700	3,70	LTC5A4D	01 02 27 49	
	44,8	3000	2576	4312	>80		1985	4,40	LTC5A5	01 02 27 49	
	44,8	3000	2576	4312	>80	x	1985	4,40	LTC5A5D	01 02 27 49	
	51,2	3000	2944	4928	>80		2265	5,10	LTC5A6	01 02 27 49	
	51,2	3000	2944	4928	>80	x	2265	5,10	LTC5A6D	01 02 27 49	
	57,6	3000	3313	5544	>80		2545	5,80	LTC5A7	01 02 27 49	
	57,6	3000	3313	5544	>80	x	2545	5,80	LTC5A7D	01 02 27 49	
	64	3000	3681	6160	>80		2825	6,50	LTC5A8	01 02 27 49	
	64	3000	3681	6160	>80	x	2825	6,50	LTC5A8D	01 02 27 49	

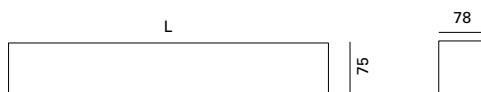

Su richiesta disponibile la versione 4000°K | On request available version 4000°K | Versión con 4000°K demanda



## FILE 2 PARETE MONO FLUO CON DIFFUSORE OPALINO

SINGLE-LAMP FLUO WITH DIFFUSER - MONO FLUO CON DIFUSOR



	W	Lmm	Kg	CODE	Col.	
T16	21-39	883	1,85	LT25A1	01 02 27 49	  
	28-54	1183	2,75	LT25A2	01 02 27 49	
	35-49-80	1483	3,20	LT25A3	01 02 27 49	
	1+1x21-39	1758	3,70	LTA5A4	01 02 27 49	
	1+1x28-54	2358	5,10	LT25A4	01 02 27 49	

Su richiesta versioni Emergenza | Emergency versions on request | Emergencia versiones bajo demanda

## BI FLUO CON DIFFUSORE OPALINO

DOUBLE-LAMP FLUO WITH DIFFUSER- BI FLUO CON DIFUSOR

	W	DaliT&D	Lmm	Kg	CODE	Col.	
T16	2x21-39		883	1,85	LT25A10	01 02 27 49	  
	2x21-39	x	883	1,85	LT25A10D	01 02 27 49	
	2x28-54		1183	2,75	LT25A11	01 02 27 49	
	2x28-54	x	1183	2,75	LT25A11D	01 02 27 49	
	2x35-49		1483	3,20	LTA5A12	01 02 27 49	
	2x35-49	x	1483	3,20	LTA5A12D	01 02 27 49	
	2x80		1483	3,20	LTB5A12	01 02 27 49	
	2+2x21-39		1758	3,70	LTA5A13	01 02 27 49	
	2+2x21-39	x	1758	3,70	LTA5A13D	01 02 27 49	
	2+2x28-54		2358	5,10	LT25A13	01 02 27 49	
	2+2x28-54	x	2358	5,10	LT25A13D	01 02 27 49	

Su richiesta versioni Emergenza | Emergency versions on request | Emergencia versiones bajo demanda

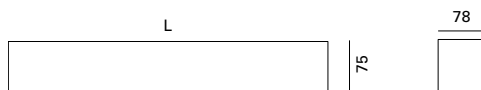

Proiettori da binario Eurostandard 230V per illuminazione diretta diffusa, per sorgenti lineari LED o lampade fluorescenti T16 e T16 seamless. Alimentazione elettronica integrata 50/60Hz 230/240V. Corpo in estruso di alluminio 75x78mm. Finitura verniciata o anodizzata. Completi di adattatore a binario, testate di chiusura laterali con sistema Light Proof e schermo diffondente in PC opalino bianco o microprismatico (conforme normativa EN12464-1) o griglia dark-light in alluminio ad alta specularità. Grado di protezione IP40.

230V Eurostandard track profile for diffused direct lighting, complete with professional linear LED source or battens for T16 linear fluorescent lamps. Complete with 50/60 Hz 230/240 V electronic power supply. Body in 75x78 mm. extruded aluminium. Painted or anodized finish. Complete with track adapter, Light Proof system side end caps, opal white or microprismatic polycarbonate diffusing screen (conform to EN 12464-1 EU directive) or high efficiency dark-light aluminium grid. IP40 protection degree.

Profiles para raíl Eurostandard 230V para iluminación directa difuminada, con LED lineales o con regletas para fluorescentes T16. Alimentación electrónica integrada 50/60Hz 230V/240V. Cuerpo en estruso de aluminio 75x78mm. Acabado pintado o anodizado. Con adaptador para raíl, tapas de cierre laterales con sistema "Light Proof" y difusor en policarbonato opal blanco o microprismático (conforme normativa EN 12464-1) o con dark-light en aluminio de gran luminosidad. Grado de protección IP40.

**FILE 2 TRACK**







RUOTE DA SOGNO REGGIO EMILIA – ITALY  
PROJECT ARCH. ANDREA OLIVA  
PHOTO KAI UWE SCHULTE BUNERC





## FILE 2 TRACK CON DIFFUSORE OPALINO

LED WITH OPALINE DIFFUSER- LED A BINARIO CON DIFFUSOR OPALINO



	W	K	lm product	lm/Led	CRI	Dali	Lmm	CODE	Col.	
LINEAR LED 24W/MT 2200LM/MT CRI>80  50000h Ta 25° L70B10	19,2	3000	1104	1848	>80		860	LTC530B	01 02 27 49	
	19,2	3000	1104	1848	>80	x	860	LTC530BD	01 02 27 49	
	25,6	3000	1472	2464	>80		1140	LTC531B	01 02 27 49	
	25,6	3000	1472	2464	>80	x	1140	LTC531BD	01 02 27 49	
	32	3000	1840	3080	>80		1420	LTC532B	01 02 27 49	
	32	3000	1840	3080	>80	x	1420	LTC532BD	01 02 27 49	
LINEAR LED 41W/MT 4640LM/MT CRI90	34,2	3000	2330	3900	90		860	LT2530AB	01 02 27 49	
	45,6	3000	3107	5200	90		1140	LT2531AB	01 02 27 49	
	57	3000	3884	6500	90		1420	LT2532AB	01 02 27 49	
T16 G5 230V	21-39						879	LT2530B	01 02 27 49	
	28-54						1179	LT2532B	01 02 27 49	
	35-49-80						1479	LT2534B	01 02 27 49	
	2x21-39						879	LT2542B	01 02 27 49	
	2x28-54						1179	LT2544B	01 02 27 49	
	2x35-49						1479	LTA546B	01 02 27 49	
2x80						1479	LTB546B	01 02 27 49		

Installabile sulla maggior parte dei binari 3 fasi in commercio. Il prodotto in finitura bianco ed ossidato alluminio prevede adattatore bianco. Il prodotto in finitura nero, ossidato inox, ossidato cromo, moka ha adattatore nero. | Can be installabile on most tracks 3 phases in trade the product in white and oxised silver mount a white track adapter. The product in black, oxised inox, oxised chrome, oxised brown mount a black track adapter. | Instaiar en la mayoria carril 3 fases en el comercio. Sel producto en acabado blanco y oxidao aluminio tiene adaptador blanco. el producto en acabado negro, de acero oxidado, oxidado cromo, mocha tiene adaptador negro.

Dali : Versione dimmerabile Dali. Adattatore compatibile con binari One Track (A.A.G. Stucchi ) o Global Track pulse (Nordic Aluminium)/ Dimmable Dali version. For connection to the One Track (A.A.G. Stucchi ) or Global Track pulse (Nordic Aluminium)/ Versione dimmable Dali. Se puede usar en el binario One Track (A.A.G. Stucchi ) or Global Track pulse (Nordic Aluminium)

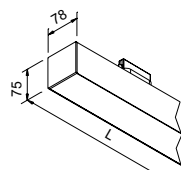



## FILE 2 TRACK CON DIFFUSORE MOCROPRISMATICO\*

LED WITH MICROPRISMATIC DIFFUSER- LED A BINARIO CON DIFFUSOR

	W	K	lm product	lm/Led	CRI	Dali	Lmm	CODE	Col.
LINEAR LED 24W/MT 2200Lm/MT CRI>80	19,2	3000	1296	1848	>80		860	LTC530BX	01 02 27 49
	19,2	3000	1296	1848	>80	x	860	LTC530BXD	01 02 27 49
	25,6	3000	1728	2464	>80		1140	LTC531BX	01 02 27 49
	25,6	3000	1728	2464	>80	x	1140	LTC531BXD	01 02 27 49
	32	3000	2160	3080	>80		1420	LTC532BX	01 02 27 49
	32	3000	2160	3080	>80	x	1420	LTC532BXD	01 02 27 49
50000h Ta 25° L70B10	A+								

PER LA VERSIONE 4000K VEDI CODICI .4 A LISTINO | FOR 4000K VERSION SEE CODE .4 ON PRICELIST | POR LA VERSIÓN 4000K VER CODIGO .4 EN LA LISTA DE PRECIOS.

	W	K	lm product	lm/W	CRI	Lmm	CODE	Col.
LINEAR LED 41W/MT 4640Lm/MT CRI90	34,2	3000	2242	114	90	860	LTC530ABX	01 02 27 49
	45,6	3000	2989	114	90	1140	LTC531ABX	01 02 27 49
	57	3000	3737	114	90	1420	LTC532ABX	01 02 27 49
A+								

PER LA VERSIONE 4000K VEDI CODICI .4 A LISTINO | FOR 4000K VERSION SEE CODE .4 ON PRICELIST | POR LA VERSIÓN 4000K VER CODIGO .4 EN LA LISTA DE PRECIOS.

T16	W	Lmm	CODE	Col.
A+-A	21-39	879	LT2530BX	01 02 27 49
	28-54	1179	LT2532BX	01 02 27 49
	35-49-80	1479	LT2534BX	01 02 27 49
	2x21-39	879	LT2542BX	01 02 27 49
	2x28-54	1179	LT2544BX	01 02 27 49
	2x35-49	1479	LTA546BX	01 02 27 49
	2x80	1479	LTB546BX	01 02 27 49

Installabile sulla maggior parte dei binari 3 fasi in commercio. Il prodotto in finitura bianco ed ossidato alluminio prevede adattatore bianco. Il prodotto in finitura nero, ossidato inox, ossidato cromo, moka ha adattatore nero. | Can be installabile on most tracks 3 phases in trade the product in white and oxidised silver mount a white track adapter. The product in black, oxidised inox, oxidised chrome, oxidised brown mount a black track adapter. | Instaiar en la mayoria carril 3 fases en el comercio. Sel producto en acabado blanco y oxidao aluminio tiene adaptador blanco. el producto en acabado negro, de acero oxidado, oxidado cromo, mocha tiene adaptador negro.

\* DIFFUSORE MICROPRISMATICO A LUMINANZA CONTROLLATA (CONFORME NORMATIVA EN 12464-1) - CONTROLLED LUMINANCE MICROPRISMATIC DIFFUSER (CONFORMS TO STANDARD EN 12464-1) - DIFUSOR MICROPRISMATICO A LUMINANCIA CONTROLADA (SEGÚN EN 12464-1)

Dali : Versione dimmerabile Dali. Adattatore compatibile con binari One Track (A.A.G. Stucchi ) o Global Track pulse (Nordic Aluminium)/ Dimmable Dali version. For connection to the One Track (A.A.G. Stucchi ) or Global Track pulse (Nordic Aluminium)/ Versione dimmable Dali. Se puede usar en el binario One Track (A.A.G. Stucchi ) or Global Track pulse (Nordic Aluminium)

## FILE 2 TRACK CON RIFLETTORE DARKLIGHT\*

FLUO WITH DARKLIGHT REFLECTOR- FLUO CON REFLECTORE DARKLIGHT

T16	W	Lmm	CODE	Col.
A+-A	21-39	879	LT2530BK	01 02 27 49
	28-54	1179	LT2532BK	01 02 27 49
	35-49-80	1479	LT2534BK	01 02 27 49
	2x21-39	879	LT2542BK	01 02 27 49
	2x28-54	1179	LT2544BK	01 02 27 49
	2x35-49	1479	LTA546BK	01 02 27 49
	2x80	1479	LTB546BK	01 02 27 49

Installabile sulla maggior parte dei binari 3 fasi in commercio. Il prodotto in finitura bianco ed ossidato alluminio prevede adattatore bianco. Il prodotto in finitura nero, ossidato inox, ossidato cromo, moka ha adattatore nero. | Can be installabile on most tracks 3 phases in trade the product in white and oxidised silver mount a white track adapter. The product in black, oxidised inox, oxidised chrome, oxidised brown mount a black track adapter. | Instaiar en la mayoria carril 3 fases en el comercio. Sel producto en acabado blanco y oxidao aluminio tiene adaptador blanco. el producto en acabado negro, de acero oxidado, oxidado cromo, mocha tiene adaptador negro.

\* RIFLETTORE A LUMINANZA CONTROLLATA (CONFORME NORMATIVA EN 12464-1) - CONTROLLED LUMINANCE REFLECTOR (CONFORMS TO STANDARD EN 12464-1) - REFLECTORE A LUMINANCIA CONTROLADA (SEGÚN EN 12464-1)

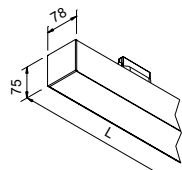

01 - bianco - white - bianco    02 - nero - black - negro    27 - ossidato alluminio - oxidised aluminium - oxidado aluminio    49 - moka - moka - moka

Sistema modulare per illuminazione diretta, diffusa e/o d'accento, composto da profili vuoti in estruso di alluminio verniciato o anodizzato 75x78 mm. di lunghezza predefinita o tagliabili a misura, disponibili nelle versioni a parete, plafone, sospensione, incasso con cornice di battuta super-slim larghezza 5 mm. e incasso rasato a scomparsa totale trimless (94x81 mm.). Da integrare con sorgenti lineari LED, reglette per lampade fluorescenti T16, incassi con sorgente LED integrata o per lampade alogene e LED QPAR16 e moduli binario max 16A 3 accensioni per inserimento di proiettori. Reglette fluorescenti complete di alimentazione elettronica 50/60Hz 230/240V. Reglette LED con driver integrati. Da completare con le testate di chiusura laterali con sistema Light Proof, schermo diffondente in PC opalino bianco o microprismatico (conforme normativa EN 12464-1), profili di chiusura, di lunghezza predefinita o tagliabili a misura, o griglia dark-light in alluminio ad alta specularità e staffe di fissaggio o cavi di sospensione. Grado di protezione IP20/IP40.

Modular system for direct, diffused and/or accent lighting, consisting of hollow profiles made from 75x78 mm painted or anodised extruded aluminium, with a predefined length or cut to measure, available in the following versions: wall-mounted, ceiling-mounted, suspended, recessed with a super-slim edge trim, just 5 mm wide, and trimless, fully-retracting flush recessed. To be integrated with LED linear light sources, battens for T16 and T16 seamless fluorescent lamps, recessed versions with built-in LED source or for QPAR16 halogen/LED lamps and max 16A 3-circuit track modules for inclusion of projectors. Fluorescent battens, complete with 50/60 Hz 230/240 V electronic power supply, LED batten driver included. To be completed with side end caps with Light Proof system, opal white or microprismatic PC diffusing screen (in accordance with EN 12464-1), closing profiles, with a predefined length or cut to measure, or dark-light aluminium grille with high specular qualities and mounting brackets or suspension cables. IP20/IP40 protection rating.

Sistema modular para la iluminación directa, difusa y/o concentrada. Compuesto de perfil vacío en estruso de aluminio barnizado o anodizado 75x78 mm. de largo predefinida o cortable a medida, disponible en la versiones de pared, plafón, suspensión, empotrado con bordillo súper-fino "super-slim" de 5 mm., y empotrado total "trimless" (94x81 mm.). Preparados para fuentes luminosas lineales LED, regletas para lámparas fluorescentes T16 y T16 seamless, proyectores con fuente luminosa LED integrada o para lámparas halógenas/LED QPAR16 y rieles binarios máx. 16A 3 encendidos, para la colocación de proyectores. Regletas para lámparas fluorescentes con alimentación electrónica 50/60Hz 230/240V. Reglette LED con alimentador incluido. Se complementan con las tapas de cierre laterales con sistema "Light Proof", difusor en PC blanco opal o micro prismático (conforme normativa EN 12464-1), perfil de cierre, de longitud predefinida o cortable a medida, o difusor dark-light en aluminio de gran luminosidad, soporte de fijación o cables de suspensión. Grado de protección IP20/IP40.

**FILE 2 SISTEMA**



GYM FITNESS ONE - AMMAN- JORDAN





TABAKALERA - CENTRO INTERNACIONAL DE CULTURA CONTEMPORÀNEA - SPAIN  
LIGHT DESIGN TAO ILLUMINACION







IDOM HEADQUARTER BILBAO - SPAIN  
PHOTO E. BIDERBOST

## PROFILO VUOTO INCASSO

RECESSED EMPTY PROFILE - PERFIL VACIO EMPOTRABLE

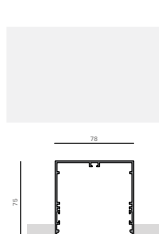

Lmm	CODE	Col.
1000	LT2524.1000	01 02 27
2000	LT2524.2000	01 02 27
3000	LT2524.3000	01 02 27
.....	LT2524.misura*	01 02 27

## COPPIA TESTATE DI CHIUSURA INCASSO

RECESSED COUPLE OF CLOSURE HEADS - EMPOTRABLE HEADS PAREJA DE TAPAS FINALES



CODE	Col.
LT2525	01 02 27

## PROFILO VUOTO INCASSO X

X-SHAPED RECESSED EMPTY PROFILE - PERFIL VACIO EMPOTRABLE X



Dim.  
640x570

CODE	Col.
LT2524.X	01 02 27

completo di molle per fissare il profilo al cartongesso  
| springs to fix the perfil to the false ceiling included  
| muelle para la fijación del perfil en el falso techo incluido

## PROFILO INCASSO PER PARETE/SOFFITTO

EMPTY PROFILE - PERFIL VACIO



Dim.  
280+75x280+75

CODE	Col.
LT2524.PS	01 02 27

completo di molle per fissare il profilo al cartongesso  
| springs to fix the perfil to the false ceiling included  
| muelle para la fijación del perfil en el falso techo incluido

## PROFILO VUOTO INCASSO 90°

90°-SHAPED RECESSED EMPTY PROFILE - PERFIL VACIO EMPOTRABLE 90°



Dim.  
360x290

CODE	Col.
LT2524.90	01 02 27

completo di molle per fissare il profilo al cartongesso  
| springs to fix the perfil to the false ceiling included  
| muelle para la fijación del perfil en el falso techo incluido

## MOLLA SINGOLA

SINGLE SPRING. - RESORTE ÚNICO



CODE
LT2526

Molla singola per fissare il profilo al controsoffitto. una ogni metro lineare (min. 2 piezas) - Single spring for fixing the profile on the false-ceiling. one every linear metre (2 pcs min)- resorte único para la fijación del perfil en el falso techo. Uno cada 1 mt. (min. 2 piezas)

## PROFILO VUOTO INCASSO T

T-SHAPED RECESSED EMPTY PROFILE - PERFIL VACIO EMPOTRABLE T



Dim.  
565x355

CODE	Col.
LT2524.T	01 02 27

completo di molle per fissare il profilo al cartongesso  
| springs to fix the perfil to the false ceiling included  
| muelle para la fijación del perfil en el falso techo incluido

Tramite questo codice è possibile ordinare il profilo in una lunghezza lineare non standard. Sostituire alla parola "misura" la lunghezza desiderata in mm. Per ordinare un profilo con una o entrambe le estremità tagliate ad angolo 45° aggiungere alla misura la lettera "D" (taglio Destro) o "S" (taglio Sinistro). Seguire istruzioni riportate a pag. 834. Per profili oltre i 3 mt e massimo 6 mt le condizioni di trasporto sono da concordare. | Through this code it's possible to order the profile in a not-standard linear length. Replace the word "misura" with the desired length in mm. To order a profile with one or both ends 45° angle-cut add the letter "D" (right cut) or "S" (left cut) to the standard or custom length. follow the instructions on page 834. for lengths over 3 mt. to max. 6 mt. transport conditions to negotiate. | el uso de este código, se puede ordenar el perfil en un lineal longitud no estándar. Sustitúyase la palabra "medida" de la longitud en mm. Para pedir un perfil con uno o ambos extremos cortados en un ángulo de 45° a añadir a la medida de la letra "D" (derecha cortada) o "S" (izquierda cortada). Siga las instrucciones de la página. 834. Perfiles para más de 3 my 6 m Condiciones máximas de transporte a convenir.

01 - bianco - white - bianco 02 - nero - black - negro 27 - ossidato alluminio - oxidised aluminium - oxidado aluminio

## PROFILO VUOTO INCASSO RASATO

TRIMLESS RECESSED EMPTY PROFILE - PERFIL VACIO TOTAL EMPOTRABLE



Lmm	CODE	Col.
1000	LT2700.1000	01
2000	LT2700.2000	01
3000	LT2700.3000	01
	LT2700.misura*	01

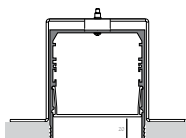

## COPPIA DITESTATE INCASSO RASATO

COUPLE OF CLOSURE HEADS - HEADS PAREJA DE TAPAS FINALES TOTAL EMPOTRABLE



CODE	Col.
LT2881	01

## PROFILO VUOTO INCASSO RASATO X

X-SHAPED TRIMLESS RECESSED EMPTY PROFILE- PERFIL VACIO TOTAL EMPOTRABLE X



Dim.	CODE	Col.
640x570	LT2700.X	01

completo di staffe per fissare il profilo al cartone  
| brackets to fix the perfil to the false ceiling included  
| soporte para la fijación del perfil en el falso techo incluido

## PROFILO RASATO PARETE/SOFFITTO

RECESSED EMPTY PROFILE - PERFIL VACIO EMPOTRABLE X



Dim.	CODE	Col.
280+95x280+95	LT2700.PS	01

completo di staffe per fissare il profilo al cartone  
| brackets to fix the perfil to the false ceiling included  
| soporte para la fijación del perfil en el falso techo incluido.

## PROFILO VUOTO INCASSO RASATO 90°

90°-SHAPED TRIMLESS RECESSED EMPTY PROFILE- PERFIL VACIO TOTAL EMPOTRABLE 90°

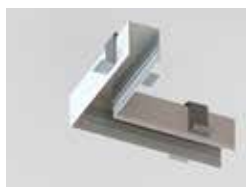

Dim.	CODE	Col.
360x290	LT2700.90	01

completo di staffe per fissare il profilo al cartone  
| brackets to fix the perfil to the false ceiling included  
| soporte para la fijación del perfil en el falso techo incluido

## STAFFA D'AGGANCIAMENTO PER RASATO

TRIMLESS MOUNTING KIT- TOTAL EMPOTRABLE SOPORTE



CODE
LT2886

Staffa singola per fissare il profilo lineare al controsoffitto. una ogni metro lineare. (minimo 2 pezzi) - Single spring for fixing the linear profile on the false-ceiling. one every linear metre. (2 pcs. min) - Resorte único para la fijación del perfil lineal en el falso techo. uno cada 1 mt. (minimo 2 piezas)

## PROFILO VUOTO INCASSO RASATO T

T-SHAPED TRIMLESS RECESSED EMPTY PROFILE- PERFIL VACIO TOTAL EMPOTRABLE T



Dim.	CODE	Col.
565x355	LT2700.T	01

completo di staffe per fissare il profilo al cartone  
| brackets to fix the perfil to the false ceiling included  
| soporte para la fijación del perfil en el falso techo incluido

\*Tramite questo codice è possibile ordinare il profilo in una lunghezza lineare non standard. Sostituire alla parola "misura" la lunghezza desiderata in mm. Per ordinare un profilo con una o entrambe le estremità tagliate ad angolo 45° aggiungere alla misura la lettera "D" (taglio Destro) o "S" (taglio Sinistro). Seguire istruzioni riportate a pag. 834. Per profili oltre i 3 mt e massimo 6 mt le condizioni di trasporto sono da concordare. | Through this code it's possible to order the profile in a not-standard linear length. Replace the word "misura" with the desired length in mm. To order a profile with one or both ends 45° angle-cut add the letter "D" (right cut) or "S" (left cut) to the standard or custom length. follow the instructions on page 834. for lengths over 3 mt. to max. 6 mt. transport conditions to negotiate. | el uso de este código, se puede ordenar el perfil en un lineal longitud no estándar. Sustitúyase la palabra "medida" de la longitud en mm. Para pedir un perfil con uno o ambos extremos cortados en un ángulo de 45° a añadir a la medida de la letra "D" (derecha cortada) o "S" (izquierda cortada). Siga las instrucciones de la página. 834. Perfiles para más de 3 my 6 m Condiciones máximas de transporte a convenir.

01 - bianco - white - bianco 02 - nero - black - negro 27 - ossidato alluminio - oxidised aluminium - oxidado aluminio



## DIFFUSORE OPALINO BIANCO PER INCASSO RASATO

OPAL WHITE POLYCARBONATE DIFFUSER FOR TRIMLESS RECESSED VERSION - DIFUSOR ON POLYCARBONATO BLANCO SATINADO POR TOTAL EMPOTRABLE

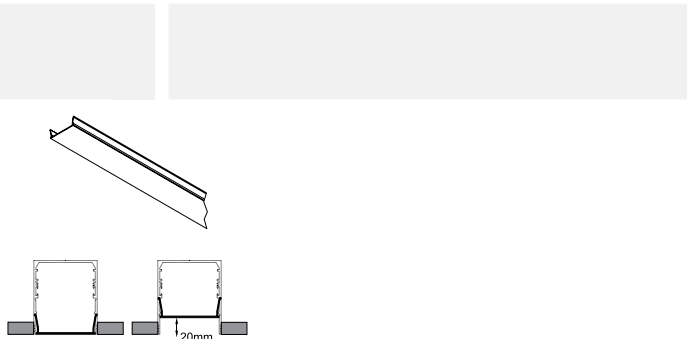

Lmm  
1000  
2000  
3000  
.....

CODE  
LT2884.1000  
LT2884.2000  
LT2884.3000  
LT2884.misura

## DIFFUSORE MICROPRISMATICO\* PER INCASSO RASATO

MICROPRISMATIC POLYCARBONATE DIFFUSER FOR TRIMLESS RECESSED VERSION - DIFUSOR EN POLYCARBONATO MICROPRISMATICO POR TOTAL EMPOTRABLE

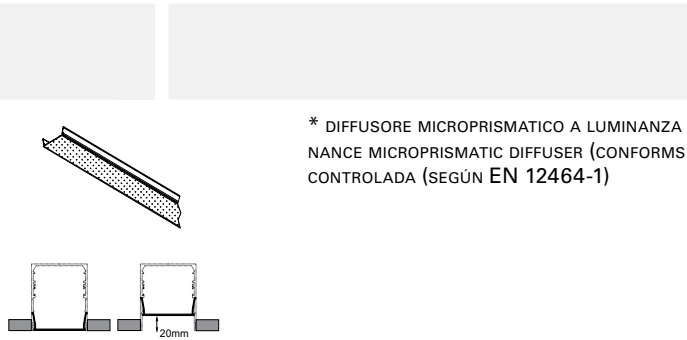

Lmm  
1000  
2000  
3000  
.....

CODE  
LT2885.1000  
LT2885.2000  
LT2885.3000  
LT2885.misura

\* DIFFUSORE MICROPRISMATICO A LUMINANZA CONTROLLATA (CONFORME NORMATIVA EN 12464-1) - CONTROLLED LUMINANCE MICROPRISMATIC DIFFUSER (CONFORMS TO STANDARD EN 12464-1) - DIFUSOR MICROPRISMATICO A LUMINANCIA CONTROLADA (SEGÚN EN 12464-1)

## GIUNTI LINEARI PER INCASSO RASATO (COPPIA)

LINEAR JOINT COUPLE FOR TRIMLESS RECESSED VERSION - PAREJA DE LINEAL UNION POR TOTAL EMPOTRABLE

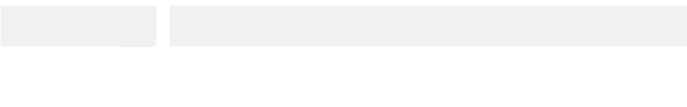

CODE  
LT2882

## GIUNTI ANGOLARI PER INCASSO RASATO (COPPIA)

90° JOINT COUPLE FOR TRIMLESS RECESSED VERSION - PAREJA DE UNION 90° POR TOTAL EMPOTRABLE

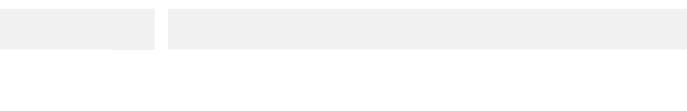

CODE  
LT2882.90

## PROFILO VUOTO SOFFITTO

CEILING EMPTY PROFILE- PERFIL VACIO TECHO



Lmm	CODE	Col.
1000	LT2513.1000	01 02 27 49
2000	LT2513.2000	01 02 27 49
3000	LT2513.3000	01 02 27 49
.....	LT2513.misura*	01 02 27 49

## COPPIA DI TESTATE SOFFITTO

COUPLE OF CLOSURE HEADS - HEADS PAREJA DE TAPAS FINALES PARA TECHO



CODE	Col.
LT2511	01 02 27 49

## PROFILO VUOTO SOFFITTO X

X-SHAPED CEILING EMPTY PROFILE- PERFIL VACIO TECHO X



Dim.	CODE	Col.
640x570	LT2513.X	01 02 27 49

## PROFILO VUOTO PARETE/SOFFITTO

EMPTY PROFILE FOR CEILING/WALL INSTALLATION- PERFIL VACIO PARA PARED/TECHO INSTALLATION



Dim.	CODE	Col.
280+75x280+75	LT2513.PS	01 02 27 49

## PROFILO VUOTO SOFFITTO 90°

90°-SHAPED CEILING EMPTY PROFILE - PERFIL VACIO TECHO 90°



Dim.	CODE	Col.
360x290	LT2513.90	01 02 27 49

## PROFILO VUOTO SOFFITTO T

T-SHAPED CEILING EMPTY PROFILE - PERFIL VACIO TECHO T



Dim.	CODE	Col.
565x355	LT2513.T	01 02 27 49

\*Tramite questo codice è possibile ordinare il profilo in una lunghezza lineare non standard. Sostituire alla parola "misura" la lunghezza desiderata in mm. Per ordinare un profilo con una o entrambe le estremità tagliate ad angolo 45° aggiungere alla misura la lettera "D" (taglio Destro) o "S" (taglio Sinistro). Seguire istruzioni riportate a pag. 834. Per profili oltre i 3 mt e massimo 6 mt le condizioni di trasporto sono da concordare. | Through this code it's possible to order the profile in a not-standard linear length. Replace the word "misura" with the desired length in mm. To order a profile with one or both ends 45° angle-cut add the letter "D" (right cut) or "S" (left cut) to the standard or custom length. follow the instructions on page 834. for lengths over 3 mt. to max. 6 mt. transport conditions to negotiate. | el uso de este código, se puede ordenar el perfil en un lineal longitud no estándar. Sustitúyase la palabra "medida" de la longitud en mm. Para pedir un perfil con uno o ambos extremos cortados en un ángulo de 45 ° a añadir a la medida de la letra "D" (derecha cortada) o "S" (izquierda cortada). Siga las instrucciones de la página. 834. Perfiles para más de 3 my 6 m Condiciones máximas de transporte a convenir.

01 - bianco - white - bianco 02 - nero - black - negro 27 - ossidato alluminio - oxidised aluminium - oxidado aluminio 49 - moka

## PROFILO VUOTO SOSPENSIONE

SUSPENSION EMPTY PROFILE - PERFIL VACIO SUSPENSION



Lmm	CODE	Col.
1000	LTB513.1000	01 02 27 49
2000	LTB513.2000	01 02 27 49
3000	LTB513.3000	01 02 27 49
.....	LTB513.misura*	01 02 27 49

## COPPIA DITESTATE SOSPENSIONE

COUPLE OF CLOSURE HEADS - HEADS PAREJA DE TAPAS FINALES PARA SUSPENSION



CODE	Col.
LT2511	01 02 27 49

## CAVI SOSPENSIONE IN ACCIAIO

STEEL SUSPENSION CABLE- CABLE SUSPENSION EN ACERO



Lmm	CODE
2000	LT5019
4000	LT5019.4

1 ogni 2 metri lineari + 1 | 1 every 2 meters + 1 | 1 cada 2 metros + 1

## KIT ALIMENTAZIONE COMPLETO DI ROSONE BIANCO

POWER CABLE KIT WITH CEILING WHITE CANOPY - KIT ALIMENTACION CON FLORON BLANCO



Dim.	Lmm	Kg	CODE	Col.
3X1	2000	0.18	LT2411	01
3X1	4000	0.36	LT2411.4000	01
4X1	2000	0.26	LT2412	01
4X1	4000	0.52	LT2412.4000	01
5X1	2000	0.30	LT2412.5	01
5X1	4000	0.60	LT2412.5.4000	01
7X1	2000	0.30	LT2412.7	01
7X1	4000	0.60	LT2412.7.4000	01
9X1	2000	0.30	LT2412.9	01
9X1	4000	0.60	LT2412.9.4000	01

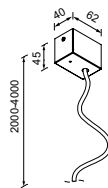

01 - bianco - white - bianco 02 - nero - black - negro 27 - ossidato alluminio - oxidised aluminium - oxidado aluminio

49 - moka

## PROFILO VUOTO PARETE

WALL EMPTY PROFILE- PERFIL VACIO PARED



Lmm	CODE	Col.
1000	LTA513.1000	01 02 27 49
2000	LTA513.2000	01 02 27 49
3000	LTA513.3000	01 02 27 49
.....	LTA513.misura*	01 02 27 49

## COPPIA DI TESTATE PARETE

COUPLE OF CLOSURE HEADS FOR WALL - HEADS PAREJA DE TAPAS FINALES PARA PARED



CODE	Col.
LT2511	01 02 27 49

## DISTANZIALE PER PROFILO E PARETE

SINGLE SPACER TO PUT BETWEEN PROFILE AND WALL- ESPACIADOR INDIVIDUAL PARA SER COLOCADO ENTRE EL PERFIL Y LA PARED



CODE
LTX001



- Uno ogni 1/1,5 mt | one every 1/1,5 mt | uno cada 1/1,5 mt

\*Tramite questo codice è possibile ordinare il profilo in una lunghezza lineare non standard. Sostituire alla parola "misura" la lunghezza desiderata in mm. Per ordinare un profilo con una o entrambe le estremità tagliate ad angolo 45° aggiungere alla misura la lettera "D" (taglio Destro) o "S" (taglio Sinistro). Seguire istruzioni riportate a pag. 834. Per profili oltre i 3 mt e massimo 6 mt le condizioni di trasporto sono da concordare. | Through this code it's possible to order the profile in a not-standard linear length. Replace the word "misura" with the desired length in mm. To order a profile with one or both ends 45° angle-cut add the letter "D" (right cut) or "S" (left cut) to the standard or custom length. follow the instructions on page 834. for lengths over 3 mt. to max. 6 mt. transport conditions to negotiate. | el uso de este código, se puede ordenar el perfil en un lineal longitud no estándar. Sustitúyase la palabra "medida" de la longitud en mm. Para pedir un perfil con uno o ambos extremos cortados en un ángulo de 45° a añadir a la medida de la letra "D" (derecha cortada) o "S" (izquierda cortada). Siga las instrucciones de la página. 834. Perfiles para más de 3 my 6 m Condiciones máximas de transporte a convenir.

01 - bianco - white - bianco 
  02 - nero - black - negro 
  27 - ossidato alluminio - oxidised aluminium - oxidado aluminio 
  49 - moka

## REGLETTE LED 24 W/MT



24W/MT LED BATTEN- REGLETTE LED 24W/MT LINEAR LED

	W	K	lm product	lm/Led	CRI	DaliT&D	Lmm	CODE	
 <p>LINEAR LED 24W/MT 2200LM/MT CRI&gt;80 230V</p> <p>50000h Ta 25° L70B10</p> <p><b>A+</b></p>	12,8	3000	1232	1232	>80		560	<b>RL23M01</b>	
	12,8	3000	1232	1232	>80	x	560	<b>RL23M01D</b>	
	19,2	3000	1848	1848	>80		840	<b>RL23M02</b>	
	19,2	3000	1848	1848	>80	x	840	<b>RL23M02D</b>	
	25,6	3000	2464	2464	>80		1120	<b>RL23M03</b>	
	25,6	3000	2464	2464	>80	x	1120	<b>RL23M03D</b>	
	32	3000	3080	3080	>80		1400	<b>RL23M04</b>	
	32	3000	3080	3080	>80	x	1400	<b>RL23M04D</b>	
	38,4	3000	3696	3696	>80		1680	<b>RL23M05</b>	
	38,4	3000	3696	3696	>80	x	1680	<b>RL23M05D</b>	
	51,2	3000	4928	4928	>80		2240	<b>RL23M07</b>	
	51,2	3000	4928	4928	>80	x	2240	<b>RL23M07D</b>	
	<p>LINEAR LED 24W/MT 2285LM/MT CRI&gt;80</p> <p>50000h Ta 25° L70B10</p>	12,8	4000	1280	1280	>80		560	
12,8		4000	1280	1280	>80	x	560	<b>RL24M01D</b>	
19,2		4000	1920	1920	>80		840	<b>RL24M02</b>	
19,2		4000	1920	1920	>80	x	840	<b>RL24M02D</b>	
25,6		4000	2560	2560	>80		1120	<b>RL24M03</b>	
25,6		4000	2560	2560	>80	x	1120	<b>RL24M03D</b>	
32		4000	3200	3200	>80		1406	<b>RL24M04</b>	
32		4000	3200	3200	>80	x	1406	<b>RL24M04D</b>	
38,4		4000	3840	3840	>80		1680	<b>RL24M05</b>	
38,4		4000	3840	3840	>80	x	1680	<b>RL24M05D</b>	
51,2		4000	5120	5120	>80		2240	<b>RL24M07</b>	
51,2		4000	5120	5120	>80	x	2240	<b>RL24M07D</b>	

alimentatore incluso | included ballast | con trasformador

## REGLETTE LED 41 W/MT CRI>90

41 W/MT CRI>90 LED BATTEN- REGLETTE LED 41 W/MT CRI>90

	W	K	lm product	lm/Led	CRI	DaliT&D	Lmm	CODE	
 <p>LINEAR LED 41W/MT 4640LM/MT CRI90</p> <p><b>A+</b></p>	22,8	3000	2600	2600	90		560	<b>RL23H01</b>	
	22,8	3000	2600	2600	90	x	560	<b>RL23H01D</b>	
	34,2	3000	3900	3900	90		840	<b>RL23H02</b>	
	34,2	3000	3900	3900	90	x	840	<b>RL23H02D</b>	
	45,6	3000	5200	5200	90		1120	<b>RL23H03</b>	
	45,6	3000	5200	5200	90	x	1120	<b>RL23H03D</b>	
	57	3000	6500	6500	90		1400	<b>RL23H04</b>	
	57	3000	6500	6500	90	x	1400	<b>RL23H04D</b>	
	68,4	3000	7800	7800	90		1680	<b>RL23H05</b>	
	68,4	3000	7800	7800	90	x	1680	<b>RL23H05D</b>	
	91,2	3000	10400	10400	90		2240	<b>RL23H07</b>	
	91,2	3000	10400	10400	90	x	2240	<b>RL23H07D</b>	
	<p>LINEAR LED 41W/MT 4820LM/MT CRI90</p>	22,8	4000	2700	2700	90		560	
22,8		4000	2700	2700	90	x	560	<b>RL24H01D</b>	
34,2		4000	4050	4050	90		840	<b>RL24H02</b>	
34,2		4000	4050	4050	90	x	840	<b>RL24H02D</b>	
45,6		4000	5400	5400	90		1120	<b>RL24H03</b>	
45,6		4000	5400	5400	90	x	1120	<b>RL24H03D</b>	
57		4000	6750	6750	90		1400	<b>RL24H04</b>	
57		4000	6750	6750	90	x	1400	<b>RL24H04D</b>	
68,4		4000	8100	8100	90		1680	<b>RL24H05</b>	
68,4		4000	8100	8100	90	x	1680	<b>RL24H05D</b>	
91,2		4000	10800	10800	90		2240	<b>RL24H07</b>	
91,2		4000	10800	10800	90	x	2240	<b>RL24H07D</b>	

alimentatore incluso | included ballast | con trasformador







## REGLETTE DIRETTA MONO FLUO

SINGLE-LAMP FLUO BATTEN- REGLETTE DIRECTO MONO FLUO

	W	DaliT&D	Lmm	CODE
 	T16 G5 230V			
	14-24		575	<b>LT2515.14-24</b>
	14-24	x	575	<b>LT15.14-24D</b>
	21-39		875	<b>LT2515.21-39</b>
	21-39	x	875	<b>LT15.21-39D</b>
	28-54		1175	<b>LT2515.28-54</b>
	28-54	x	1175	<b>LT15.28-54D</b>
	35-49-80		1475	<b>LT2515.35-49-80</b>
	35-49-80	x	1475	<b>LT15.35-80D</b>

## REGLETTE BI FLUO

DOUBLE-LAMP FLUO BATTEN- REGLETTE BI FLUO

	W	DaliT&D	Lmm	CODE
 	T16			
	2x14-24		575	<b>LT2516.14-24</b>
	2x14-24	x	575	<b>LT16.14-24D</b>
	2x21-39		875	<b>LT2516.21-39</b>
	2x21-39	x	875	<b>LT16.21-39D</b>
	2x28-54		1175	<b>LT2516.28-54</b>
	2x28-54	x	1175	<b>LT16.28-54D</b>
	2x35-49		1475	<b>LT16.35-49</b>
	2x35-49	x	1475	<b>LT16.35-49D</b>
	2x80		1475	<b>LT16.80</b>
				  

## REGLETTE MONO FLUO OVERLAP LUCE CONTINUA

SINGLE-LAMP FLUO OVERLAP CONTINUOUS LIGHTING BATTEN- REGLETTE MONO FLUO OVERLAP LUZ CONTINUA

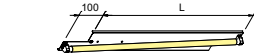



	W	DaliT&D	Lmm	CODE
 	T16			
	14-24		495+80 o 100	<b>LT2514.14-24</b>
	14-24	x	495+80 o 100	<b>LT14.14-24D</b>
	21-39		775+100	<b>LT2514.21-39</b>
	21-39	x	775+100	<b>LT14.21-39D</b>
	28-54		1075+100	<b>LT2514.28-54</b>
	28-54	x	1075+100	<b>LT14.28-54D</b>
	35-49-80		1375+100	<b>LT2514.35-49-80</b>
	35-49-80	x	1375+100	<b>LT14.35-49-80D</b>

Attenzione nel caso di utilizzo di sole reglette da 495mm la sovrapposizione da sommare sarà di 80mm | Attention in the case of use of 495mm battens only the overlap to be added will be 80mm, in the case of mixed combinations the overlap to be added will be of 100mm | Atención en el caso de uso de sol reglette 495mm añadir 80 mm para la superposición, en el caso de combinaciones mixtas la superposición ser añadido serán de 100mm.

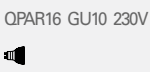

## MODULO SPOT

SPOT MODULE- MÓDULO SPOT

	W	K	Im product	Im/Led	CRI	∠	Lmm	CODE	Col.			
 <p>LED</p> <p>3SDCM 50000h L90 B10 ta 25°C</p> <p><b>A+</b></p>	6,8	2700	321	480	>90	24°	300	LT2506.927F	01 02			
	6,8	2700	437	480	>90	36°	300	LT2506.927W	01 02			
	6,8	3000	330	494	>90	24°	300	LT2506.930F	01 02			
	6,8	3000	450	494	>90	36°	300	LT2506.930W	01 02			
	2x6,8	2700	641	960	>90	24°	300	LT2507.927F	01 02			
	2x6,8	2700	874	960	>90	36°	300	LT2507.927W	01 02			
	2x6,8	3000	660	988	>90	24°	300	LT2507.930F	01 02			
	2x6,8	3000	900	988	>90	36°	300	LT2507.930W	01 02			
	3x6,8	2700	962	1440	>90	24°	300	LT2508.927F	01 02			
	3x6,8	2700	1312	1440	>90	36°	300	LT2508.927W	01 02			
	3x6,8	3000	990	1482	>90	24°	300	LT2508.930F	01 02			
	3x6,8	3000	1350	1482	>90	36°	300	LT2508.930W	01 02			
	 <p>QPAR16 GU10 230V</p>	1x50						300	LT2506		01 02	
		2x50						300	LT2507		01 02	
3x50							300	LT2508	01 02			

## STRIP BOBINA DA 5 METRI

STRIP LED 5 METERS ROLL- BOBINA STRIP LED 5 METROS

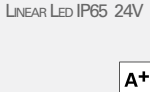
	W/mt	V	Led/mt	Im/mt	K	Im product	Im/W	CRI	IP	A	Lmm	Kg	CODE	
 <p>LINEAR LED 24V</p> <p><b>A+</b></p>	5,5	24	60	270	3000	1350	245	80	20	V.1	5000	0,18	ST05.30.5	
	9,6	24	120	540	3000	2700	281	80	20	V.1	5000	0,18	ST10.30.5	
	11	24	180	1200	3000	6000	545	80	20	V.1	5000	0,18	ST11.30.5	
	18	24	168	2200	3000	11000	611	80	20	V.1	5000	0,18	ST21.30.5	
 <p>LINEAR LED IP65 24V</p> <p><b>A+</b></p>	9,6	24	120	540	3000	2700	281	80	65	V.1	5000	0,18	ST10.30.5IP	
	14,4	24	60	900	3000	4500	313	80	65	V.1	5000	0,18	ST15.30.5IP	
	19,2	24	240	1080	3000	5400	281	80	65	V.1	5000	0,18	ST20.30.5IP	

## DISSIPATORE DIRETTO PER STRIP LED

DIRECT EMISSION HEAT SINCK FOR STRIP LED- DISIPADOR DIRECTO PARA STRIP LED

	Lmm	CODE	
	1000	LTC2.1000	
	2000	LTC2.2000	
	3000	LTC2.3000	
	.....	LTC2.misura*	

\*Tramite questo codice è possibile ordinare il profilo in una lunghezza lineare non standard. Sostituire alla parola "misura" la lunghezza desiderata in mm. Seguire istruzioni riportate a pag. 834. Per profili oltre i 3 mt e massimo 6 mt le condizioni di trasporto sono da concordare. | Through this code it's possible to order the profile in a not-standard linear length. Replace the word "misura" with the desired length in mm. Follow the instructions on page 834. for lengths over 3 mt. to max. 6 mt. transport conditions to negotiate. | el uso de este código, se puede ordenar el perfil en un lineal longitud no estándar. Sustituyase la palabra "medida" de la longitud en mm. Siga las instrucciones de la página. 834. Perfiles para más de 3 my 6 m Condiciones máximas de transporte a convenir.



## MODULO BINARIO EUROSTANDARD 230V ON/OFF DALI 1-10V

230V TRACK MODULE - MODULO CARRIL





Lmm	Kg	CODE	Col.
1000	0.92	LT25T.1000	01 02
2000	1.83	LT25T.2000	01 02
3000	2.75	LT25T.3000	01 02

Da completare con gli accessori | To complete with accessories | Para completar con accesorios

## ALIMENTAZIONE DI TESTA DX

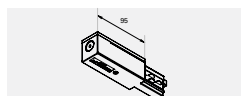
RIGHT HEAD FEED FOR TRACK SYSTEM- ALIMENTACIÓN DE CABECERA DERECHA TRACK SYSTEM





CODE	Col.
LT9020.1	01 02

Possibilità di gestione separata di tre circuiti On/Off oppure di gestione tramite segnale digitale (DALI)

## ALIMENTAZIONE DI TESTA SX

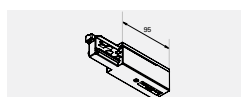
LEFT HEAD FEED FOR TRACK SYSTEM- ALIMENTACIÓN DE CABECERA IZQUIERDA TRACK SYSTEM





CODE	Col.
LT9021.1	01 02

Possibilità di gestione separata di tre circuiti On/Off oppure di gestione tramite segnale digitale (DALI)

## GIUNTO LINEARE

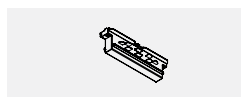
CONNECTOR FOR TRACK SYSTEM- UNIONES TRACK SYSTEM



CODE	Col.
LT9023.1	01 02

## TAPPO DI CHIUSURA

BLIND END TRACK SYSTEM- TAPA DE CIERRE TRACK SYSTEM

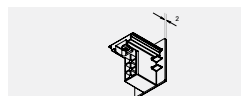

CODE	Col.
LT9033.1	01 02

## PARATIA DIVISORIA SINGOLA MODULO FLUO/BINARIO

INTERMEDIATE SINGLE HEAD FOR FLUO/ TRACK MODULE- TAPA SINGULO INTERMEDIO MODULO FLUO/CARRIL



CODE	Col.
LTRF2	01

01 - bianco - white - blanco 02 - nero - black - negro

VEDI PROIETTORI DA BINARIO - SEE PROJECTORS FOR TRACK - VER PROYECTORES POR CARRIL PAG.574



## GIUNTI LINEARI COPPIA

LINEAR CONNECTORS COUPLE- CONNECTOR LINEAR PAREJA



CODE  
LT2512

Non installabile su File2 incasso rasato / not suitable for File2 trimless recessed / no es adecuado por el perfil File2 totalmente empotrado

## GIUNTI ANGOLARI COPPIA

COUPLE OF ANGLE CONNECTORS- CONNECTOR ANGULO PAREJA



CODE  
LT2512.90

Non installabile su File2 incasso rasato / not suitable for File2 trimless recessed / no es adecuado por el perfil File2 totalmente empotrado

## GIUNTI ANGOLARI COPPIA PARETE/SOFFITTO COPPIA

COUPLE OF WALL/CEILING ANGLE CONNECTORS - PAREJA DE CONECTORES ANGULO PARED/TECHO



CODE  
LT2512.90P

Non installabile su File2 incasso rasato / not suitable for File2 trimless recessed / no es adecuado por el perfil File2 totalmente empotrado

\*Tramite questo codice è possibile ordinare il profilo in una lunghezza lineare non standard. Sostituire alla parola "misura" la lunghezza desiderata in mm. Per ordinare un profilo con una o entrambe le estremità tagliate ad angolo 45° aggiungere alla misura la lettera "D" (taglio Destro) o "S" (taglio Sinistro). Seguire istruzioni riportate a pag. 834. Per profili oltre i 3 mt e massimo 6 mt le condizioni di trasporto sono da concordare. | Through this code it's possible to order the profile in a not-standard linear length. Replace the word "misura" with the desired length in mm. To order a profile with one or both ends 45° angle-cut add the letter "D" (right cut) or "S" (left cut) to the standard or custom length. follow the instructions on page 834. for lengths over 3 mt. to max. 6 mt. transport conditions to negotiate. | el uso de este código, se puede ordenar el perfil en un lineal longitud no estándar. Sustitúyase la palabra "medida" de la longitud en mm. Para pedir un perfil con uno o ambos extremos cortados en un ángulo de 45° a añadir a la medida de la letra "D" (derecha cortada) o "S" (izquierda cortada). Siga las instrucciones de la página. 834. Perfiles para más de 3 my 6 m Condiciones máximas de transporte a convenir.

## DIFFUSORE IN POLICARBONATO OPALINO BIANCO

OPAL WHITE POLYCARBONATE DIFFUSER- DIFUSOR OPALINO BLANCO EN POLICARBONATO

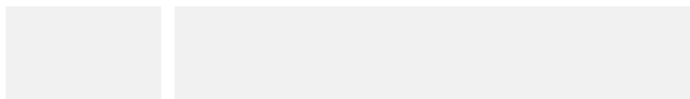

Lmm

1000  
2000  
3000  
.....

CODE

LT2506P1000  
LT2506P2000  
LT2506P3000  
LT2506Pmisura\*

Non installabile su File2 incasso rasato / not suitable for File2 trimless recessed / no es adecuado por el perfil File2 totalmente empotrado

## DIFFUSORE IN POLICARBONATO MICROPRISMATICO\*

MICROPRISMATIC POLYCARBONATE DIFFUSER- DIFUSOR MICROPRISMATICO EN POLICARBONATO

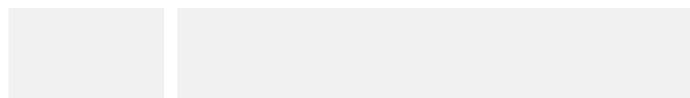

Lmm

1000  
2000  
3000  
.....

CODE

LT2506X.1000  
LT2506X.2000  
LT2506X.3000  
LT2506X.misura\*

Non installabile su File2 incasso rasato / not suitable for File2 trimless recessed / no es adecuado por el perfil File2 totalmente empotrado

\* DIFFUSORE MICROPRISMATICO A LUMINANZA CONTROLLATA (CONFORME NORMATIVA EN 12464-1) - CONTROLLED LUMINANCE MICROPRISMATIC DIFFUSER (CONFORMS TO STANDARD EN 12464-1) - DIFUSOR MICROPRISMATICO A LUMINANZA CONTROLADA (SEGUN EN 12464-1)

## RIFLETTORE DARK LIGHT

DARK LIGHT REFLECTOR- REFLECTOR DARK LIGHT

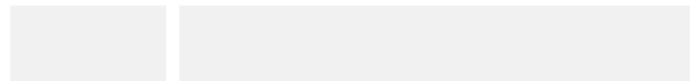

Lmm

874  
1174  
1474

CODE

LT2484  
LT2485  
LT2486

Solo per reglette t16 | For t16 Batten only | solo por la reglette t16

Non installabile su File2 incasso rasato / not suitable for File2 trimless recessed / no es adecuado por el perfil File2 totalmente empotrado

## PROFILO DI CHIUSURA IN ESTRUSO DI ALLUMINIO

EXTRUDED ALUMINIUM CLOSING COVER- TAPA EN EXTRUSO DE ALUMINIO

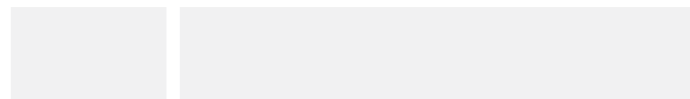

Lmm

1000  
2000  
3000  
.....

CODE

LTT2.1000 01 02 27 49  
LTT2.2000 01 02 27 49  
LTT2.3000 01 02 27 49  
LTT2.misura\* 01 02 27 49

Col.

Non installabile su File2 incasso rasato / not suitable for File2 trimless recessed / no es adecuado por el perfil File2 totalmente empotrado

01 - bianco - white - blanco 02 - nero - black - negro 27 - ossidato alluminio - oxidised aluminium - oxidado aluminio

49 - moka



IDOM HEADQUARTER BILBAO - SPAIN  
PHOTO E. BIDERBOST



## CONTAINER/CASSAFORMA

WALLBOX- CAJA



Dim.	H	L:mm	CODE	Col.
95	107	1000	LTF2.1000	01 02 27
95	107	2000	LTF2.2000	01 02 27
95	107	3000	LTF2.3000	01 02 27
95	107	.....	LTF2.misura*	01 02 27

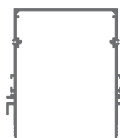

## COPPIA DITESTATE

COUPLE OF CLOSURE HEADS FOR WALLBOX TAPAS FINAL POR ENCOFRADO



CODE	Col.
LT2890	01 02 27

## CASSAFORMA GIUNTO X

X -SHAPED EMPTY PROFILE FOR BRICK WALL/PLASTERBOARD- PERFIL VACIO LADRILLO/CARTON-YESO X



Dim.	CODE	Col.
645x565	LTF2.X	01 02 27

## CASSAFORMA PARETE/SOFFITTO

WALL/CEILING EMPTY PROFILE - PERFIL VACIO PARED/TECHO



Dim.	CODE	Col.
280+107x280+107	LTF2.PS	01 02 27

## CASSAFORMA GIUNTO 90°

90° - EMPTY PROFILE FOR BRICK WALL/PLASTERBOARD- PERFIL VACIO LADRILLO/CARTON-YESO 90°

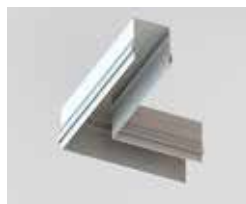

Dim.	CODE	Col.
365x285	LTF2.90	01 02 27

## GIUNTI LINEARI COPPIA

LINEAR JOINT COUPLE FOR WALLBOX- CAJA PAREJA DE LINEAL UNION



CODE
LT2892

## CASSAFORMA GIUNTO T

T-SHAPED EMPTY PROFILE FOR BRICK WALL/PLASTERBOARD - PERFIL VACIO LADRILLO/CARTON-YESO T



Dim.	CODE	Col.
565x365	LTF2.T	01 02 27

## GIUNTI ANGOLARI COPPIA

ANGLE CONNECTORS COUPLE- CONNECTOR ANGULO PAREJA



CODE
LTM211.90

01 - bianco - white - bianco 02 - nero - black - negro 27 - ossidato alluminio - oxidised aluminium - oxidado aluminio



## GIUNTI LINEARI COPPIA

LINEAR JOINT COUPLE FOR WALLBOX- CAJA PAREJA DE LINEAL UNION

CODE  
LT2892



## GIUNTI ANGOLARI COPPIA

ANGLE CONNECTORS COUPLE- CONNECTOR ANGULO PAREJA

CODE  
LTM211.90



## COPPIA DI STAFFE DI FISSAGGIO PER CARTONGESSO

COUPLE OF FIXING BRACKETS IN THE FALSE-CEILING - PAREJA DE SOPORTES PARA FIJACIÓN EN FALSO TECHO

CODE  
LTSC01



Coppia di staffe di fissaggio per cartongesso 1 ogni 1,5 mt. - couple of fixing brackets in the false-ceiling 1 per 0,5 mt. - pareja de soportes para fijación en falso techo 1 por 1,5 mt.

## STAFFA SINGOLA PER FISSAGGIO MODULO LUMINOSO

SINGLE BRACKET- SOPORTE INDIVIDUAL

CODE  
LT2891



Staffa per fissaggio modulo luminoso all'interno della cassaforma. ordinare 1 al mt. (minimo 2 pezzi) | Single bracket to Fix the lighting module within the wallbox, order 1 per mt. (min. 2 pcs) | soporte individual por fijar el encofrado, solicite 1 por mt. (2pcs mínimo)

## FASCETTA REGGICAVO PER CASSAFORMA

TIE CABLE LOCKING- ABRAZADERA DE CABLE

CODE  
LTSC04



Fascetta reggicavo - ordinare 1 ogni 0,5 mt (minimo 2pezzi) - Tie cable locking - order 1 per 0,5 mt. (min.2pcs) - Abrazadera de cable - solicite 1 por 0,5 mt. (2pcs mínimo)

\*Tramite questo codice è possibile ordinare il profilo in una lunghezza lineare non standard. Sostituire alla parola "misura" la lunghezza desiderata in mm. Per ordinare un profilo con una o entrambe le estremità tagliate ad angolo 45° aggiungere alla misura la lettera "D" (taglio Destro) o "S" (taglio Sinistro). Seguire istruzioni riportate a pag. 834. Per profili oltre i 3 mt e massimo 6 mt le condizioni di trasporto sono da concordare. | Through this code it's possible to order the profile in a not-standard linear length. Replace the word "misura" with the desired length in mm. To order a profile with one or both ends 45° angle-cut add the letter "D" (right cut) or "S" (left cut) to the standard or custom length. follow the instructions on page 834. for lengths over 3 mt. to max. 6 mt. transport conditions to negotiate. | el uso de este código, se puede ordenar el perfil en un lineal longitud no estándar. Sustitúyase la palabra "medida" de la longitud en mm. Para pedir un perfil con uno o ambos extremos cortados en un ángulo de 45 ° a añadir a la medida de la letra "D" (derecha cortada) o "S" (izquierda cortada). Siga las instrucciones de la página. 834. Perfiles para más de 3 my 6 m Condiciones máximas de transporte a convenir.

## FARETEN FOCUS 55S

	W	K	lm product	lm/Led	CRI	△	Dali	Dim.	H	Lmm	CODE	Col.
 <p>LED</p> <p>3SDCM 50000h L90 B10 ta 25°C</p> <p><b>A+</b></p>	11	2700	931	1100	>90	29°		ø55	115	300x75	<b>FR024.927S</b>	<b>01 02</b>
	11	2700	931	1100	>90	29°	x	ø55	115	300x75	<b>FR024.927SD</b>	<b>01 02</b>
	11	2700	703	1100	>90	42°		ø55	115	300x75	<b>FR024.927F</b>	<b>01 02</b>
	11	2700	703	1100	>90	42°	x	ø55	115	300x75	<b>FR024.927FD</b>	<b>01 02</b>
	11	3000	1003	1185	>90	29°		ø55	115	300x75	<b>FR024.930S</b>	<b>01 02</b>
	11	3000	1003	1185	>90	29°	x	ø55	115	300x75	<b>FR024.930SD</b>	<b>01 02</b>
	11	3000	757	1185	>90	42°		ø55	115	300x75	<b>FR024.930F</b>	<b>01 02</b>
	11	3000	757	1185	>90	42°	x	ø55	115	300x75	<b>FR024.930FD</b>	<b>01 02</b>

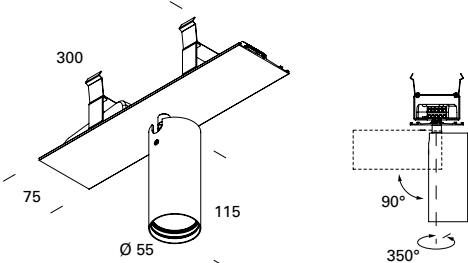

## FARETEN OCCHIO S

	W	mA	K	lm product	lm/Led	CRI	Dali	△	Dim.	Lmm	CODE	Col.
 <p>LED</p> <p>50000h L90 B10 ta 25°C</p> <p><b>A+</b></p>	5		2700	310	395	95		22°	ø40	300x75	<b>FR025.927F</b>	<b>01 02</b>
	5		2700	310	395	95	x	22°	ø40	300x75	<b>FR025.927FD</b>	<b>01 02</b>
	5		3000	310	395	95		22°	ø40	300x75	<b>FR025.930F</b>	<b>01 02</b>
	5		3000	310	395	95	x	22°	ø40	300x75	<b>FR025.930FD</b>	<b>01 02</b>

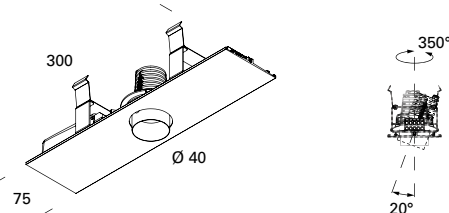

## LEVA ELEMENTO INCASSO RASATO 5+5

5+5 LAMPS TRIMLESS MODULE - MODULO TOTAL EMPOTRABLE 5+5 LAMPARA

	W	K	lm product	lm/Led	CRI	Dali	∠	Dim.	CODE	Col.
 <p>LED</p> <p>3SDCM 50000h L90 B10 Ta 25°C</p> <p><b>A+</b></p>	10x1,5	2700	1960	1680	95		19°	74,5x300	LV121.927S	01 02 41 42
	10x1,5	2700	1960	1680	95	x	19°	74,5x300	LV121.927SD	01 02 41 42
	10x1,5	2700	1410	1680	95		33°	74,5x300	LV121.927F	01 02 41 42
	10x1,5	2700	1410	1680	95	x	33°	74,5x300	LV121.927FD	01 02 41 42
	10x1,5	2700	1550	1680	95		56°	74,5x300	LV121.927W	01 02 41 42
	10x1,5	2700	1550	1680	95	x	56°	74,5x300	LV121.927WD	01 02 41 42
	10x1,5	3000	1960	1680	95		19°	74,5x300	LV121.930S	01 02 41 42
	10x1,5	3000	1960	1680	95	x	19°	74,5x300	LV121.930SD	01 02 41 42
	10x1,5	3000	1410	1680	95		33°	74,5x300	LV121.930F	01 02 41 42
	10x1,5	3000	1410	1680	95	x	33°	74,5x300	LV121.930FD	01 02 41 42
	10x1,5	3000	1550	1680	95		56°	74,5x300	LV121.930W	01 02 41 42
	10x1,5	3000	1550	1680	95	x	56°	74,5x300	LV121.930WD	01 02 41 42
	10x1,5	4000	1960	1680	95		19°	74,5x300	LV121.940S	01 02 41 42
	10x1,5	4000	1960	1680	95	x	19°	74,5x300	LV121.940SD	01 02 41 42
	10x1,5	4000	1410	1680	95		33°	74,5x300	LV121.940F	01 02 41 42
	10x1,5	4000	1410	1680	95	x	33°	74,5x300	LV121.940FD	01 02 41 42
	10x1,5	4000	1550	1680	95		56°	74,5x300	LV121.940W	01 02 41 42
	10x1,5	4000	1550	1680	95	x	56°	74,5x300	LV121.940WD	01 02 41 42

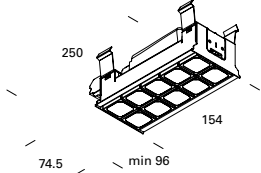
## LEVA ELEMENTO INCASSO RASATO 10+10

10+10 LAMPS TRIMLESS MODULE - MODULO TOTAL EMPOTRABLE 10+10 LAMPARA

	W	K	lm product	lm/Led	CRI	Dali	∠	Dim.	CODE	Col.
 <p>LED</p> <p>3SDCM 50000h L90 B10 Ta 25°C</p> <p><b>A+</b></p>	20x1,5	2700	3920	3360	95		19°	74,5x300	LV122.927S	01 02 41 42
	20x1,5	2700	3920	3360	95	x	19°	74,5x300	LV122.927SD	01 02 41 42
	20x1,5	2700	2820	3360	95		33°	74,5x300	LV122.927F	01 02 41 42
	20x1,5	2700	2820	3360	95	x	33°	74,5x300	LV122.927FD	01 02 41 42
	20x1,5	2700	3100	3360	95		56°	74,5x300	LV122.927W	01 02 41 42
	20x1,5	2700	3100	3360	95	x	56°	74,5x300	LV122.927WD	01 02 41 42
	20x1,5	3000	3920	3360	95		19°	74,5x300	LV122.930S	01 02 41 42
	20x1,5	3000	3920	3360	95	x	19°	74,5x300	LV122.930SD	01 02 41 42
	20x1,5	3000	2820	3360	95		33°	74,5x300	LV122.930F	01 02 41 42
	20x1,5	3000	2820	3360	95	x	33°	74,5x300	LV122.930FD	01 02 41 42
	20x1,5	3000	3100	3360	95		56°	74,5x300	LV122.930W	01 02 41 42
	20x1,5	3000	3100	3360	95	x	56°	74,5x300	LV122.930WD	01 02 41 42
	20x1,5	4000	3920	3360	95		19°	74,5x300	LV122.940S	01 02 41 42
	20x1,5	4000	3920	3360	95	x	19°	74,5x300	LV122.940SD	01 02 41 42
	20x1,5	4000	2820	3360	95		33°	74,5x300	LV122.940F	01 02 41 42
	20x1,5	4000	2820	3360	95	x	33°	74,5x300	LV122.940FD	01 02 41 42
	20x1,5	4000	3100	3360	95		56°	74,5x300	LV122.940W	01 02 41 42
	20x1,5	4000	3100	3360	95	x	56°	74,5x300	LV122.940WD	01 02 41 42

- 01** - telaio bianco - ottica nera - white box - black optic - marco blanco optica negra
- 02** - telaio nero - ottica nera - black box - black optic - marco negro - optica negra
- 41** - telaio bianco - ottica bianca - white box - white optic - marco blanco - optica blanca
- 42** - telaio nero - ottica dorata - black box - golden optic - marco negro - optica dorada

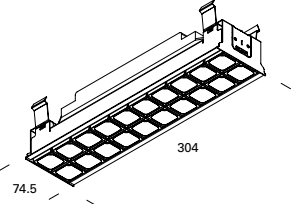
## FILE2 COMPLEMENTI 1



	W	K	Im product	Im/Led	CRI	∠	Dim.	H	CODE	Col.	
LED 3SDCM 50000h L90 B10 ta 25°C	1x6,8	3000	330	494	>90	24°	78x78	110	LT2660.930F	01 02 49	
	1x6,8	3000	450	494	>90	36°	78x78	110	LT2660.930W	01 02 49	
	1x6,8	4000	363	544	>90	24°	78x78	110	LT2660.940F	01 02 49	
	1x6,8	4000	496	544	>90	36°	78x78	110	LT2660.940W	01 02 49	
QPAR16 GU10 230V	1x50						78x78	110	LT2660	01 02 49	

## FILE2 COMPLEMENTI 2



	W	K	Im product	Im/Led	CRI	∠	Dim.	H	CODE	Col.	
LED 3SDCM 50000h L90 B10 ta 25°C	2x6,8	3000	660	988	>90	24°	78x160	110	LT2661.930F	01 02 49	
	2x6,8	3000	900	988	>90	36°	78x160	110	LT2661.930W	01 02 49	
	2x6,8	4000	727	1088	>90	24°	78x160	110	LT2661.940F	01 02 49	
	2x6,8	4000	991	1088	>90	36°	78x160	110	LT2661.940W	01 02 49	
QPAR16 GU10 230V	2x50						78x160	110	LT2661	01 02 49	

## FILE2 COMPLEMENTI 3



	W	K	Im product	Im/Led	CRI	∠	Dim.	H	CODE	Col.	
LED 3SDCM 50000h L90 B10 ta 25°C	3x6,8	3000	990	1482	>90	24°	78x250	110	LT2662.930F	01 02 49	
	3x6,8	3000	1350	1482	>90	36°	78x250	110	LT2662.930W	01 02 49	
	3x6,8	4000	1090	1632	>90	24°	78x250	110	LT2662.940F	01 02 49	
	3x6,8	4000	1487	1632	>90	36°	78x250	110	LT2662.940W	01 02 49	
QPAR16 GU10 230V	3x50						78x250	110	LT2662	01 02 49	





*Villa*

KITCHEN - PREP

*Villa Crespi*

KITCHEN - PREPARING HEALS

*Crespi*

PARING MEALS





Serie di apparecchi a sospensione e parete per illuminazione diretta e indiretta diffusa, per sorgenti lineari LED o lampade fluorescenti T16. Alimentazione elettronica integrata 50/60Hz 230/240V. Corpo in estruso di alluminio 110x78mm. Finitura verniciata o anodizzata. Completi di cavi di sospensione in acciaio con sistema di regolazione micrometrica e cavo di alimentazione l. 2000 mm., testate di chiusura laterali con sistema Light Proof e schermo diffondente in PC opalino bianco o microprismatico (conforme normativa EN12464-1) o griglia dark-light in alluminio ad alta specularità. Grado di protezione IP20 e IP40.

Series of suspended and wall-mounted fixtures for direct and indirect diffused lighting. For integrated linear LED sources or for T16 and seamless T16 fluorescent lamps. 230/240V 50/60Hz integrated electronic supply. Body in 110x78 mm. extruded aluminium. Painted or anodized finish. Complete with steel suspension cables with micrometric regulation system and feed cable l. 2000 mm., with Light Proof system side end caps and opal white or microprismatic (conform to EN 12464-1 EU directive) polycarbonate diffuser or high efficiency dark-light aluminium grid. Protection degree IP20 or IP40.

Serie de aparatos de suspensión y pared directa, difusa, preparados para fuentes luminosas lineales LED y para lámparas fluorescentes T16 con alimentación electrónica 50/60Hz 230/240V. Perfil en estruso de aluminio barnizado o anodizado 110X78. Completo de cables de suspensión de acero con sistema de regulación micrométrica y el cable de alimentación. 2000 mm, con las cable tapas de cierre laterales con sistema "Light Proof"; difusor en PC blanco opal o micro prismático (conforme normativa EN 12464-1), o difusor dark-light en aluminio de gran luminosidad. Grado de protección IP20 o IP40.

---

**FILE 2H**





STUDIO DENTISTICO ASSOCIATO "VIA GRANDI" - ITALY  
PROJECT ARCH. L.GASPARRI - LIGHTING BY FORMAT DESIGN STUDIO  
PHOTO M.FLORES





## SEZIONI PROFILO FILE 2H

### SOSPENSIONE - SUSPENSION - SUSPENSIÓN PARETE - WALL - PARED

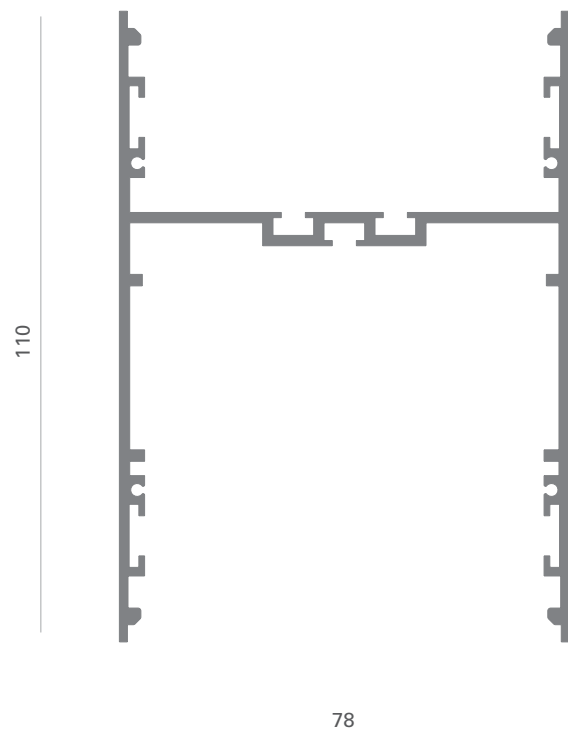

diffusore in policarbonato opalino  
opaline polycarbonate diffuser  
difusor en policarbonato opalino

diffusore microprismatico  
microprismatic diffuser  
difusor microprismatico

riflettore darklight  
darklight grid  
reflector darklight





## FILE 2H SOSPENSIONE LED BI-EMISSIONE CON DIFFUSORE OPALINO

LED DOUBLE EMISSION WITH OPALINE DIFFUSER- LED BI-EMISIÓN CON DIFUSOR OPALINO



	W	K	lm product	lm/Led	CRI	DaliT&D	Lmm	CODE	Col.
LINEAR LED 24W/MT 2200LM/MT CRI>80	2x19,2	3000	2208	3696	>80		860	LTC630	01 02 27 49
	2x19,2	3000	2208	3696	>80	x	860	LTC630D	01 02 27 49
	2x25,6	3000	2944	4928	>80		1140	LTC631	01 02 27 49
	2x25,6	3000	2944	4928	>80	x	1140	LTC631D	01 02 27 49
	2x32	3000	3681	6160	>80		1420	LTC632	01 02 27 49
	2x32	3000	3681	6160	>80	x	1420	LTC632D	01 02 27 49
	2x38,4	3000	4417	7392	>80		1700	LTC633	01 02 27 49
	2x38,4	3000	4417	7392	>80	x	1700	LTC633D	01 02 27 49
	2x44,8	3000	5153	8624	>80		1985	LTC634	01 02 27 49
	2x44,8	3000	5153	8624	>80	x	1985	LTC634D	01 02 27 49
	2x51,2	3000	5889	9856	>80		2265	LTC635	01 02 27 49
	2x51,2	3000	5889	9856	>80	x	2265	LTC635D	01 02 27 49
	2x57,6	3000	6625	11088	>80		2545	LTC636	01 02 27 49
	2x57,6	3000	6625	11088	>80	x	2545	LTC636D	01 02 27 49
	2x64	3000	7361	12320	>80		2825	LTC637	01 02 27 49
	2x64	3000	7361	12320	>80	x	2825	LTC637D	01 02 27 49

Su richiesta disponibile la versione 4000°K | On request available version 4000°K | Versión con 4000°K demanda



## FLUO BI-EMISSIONE CON DIFFUSORE OPALINO

FLUO DOUBLE EMISSION WITH OPALINE DIFFUSER- FLUO BI-EMISIÓN CON DIFUSOR OPALINO

	W	DaliT&D	Lmm	CODE	Col.
T16 G5 230V	1+1x21-39		883	LT2630	01 02 27 49
	1+1x21-39	x	883	LT2630D	01 02 27 49
	1+1x28-54		1183	LT2632	01 02 27 49
	1+1x28-54	x	1183	LT2632D	01 02 27 49
	1+1x35-49-80		1483	LT2634	01 02 27 49
	1+1x35-49-80	x	1483	LT2634D	01 02 27 49
	2+2x21-39		1758	LTA636	01 02 27 49
	2+2x21-39	x	1758	LTA636D	01 02 27 49
	2+2x28-54		2358	LT2637	01 02 27 49
	2+2x28-54	x	2358	LT2637D	01 02 27 49
	2+2x35-49		2958	LTA638	01 02 27 49
	2+2x35-49	x	2958	LTA638D	01 02 27 49
	2+2x80		2958	LTA639	01 02 27 49

A<sup>+</sup>-A



## BI FLUO BI-EMISSIONE CON DIFFUSORE OPALINO

DOUBLE-LAMP FLUO DOUBLE-EMISSION WITH OPALINE DIFFUSER- BI FLUO BI-EMISIÓN CON DIFUSOR OPALINO

	W	DaliT&D	Lmm	CODE	Col.
T16 G5 230V	2+2x21-39		883	LT2642	01 02 27 49
	2+2x21-39	x	883	LT2642D	01 02 27 49
	2+2x28-54		1183	LT2644	01 02 27 49
	2+2x28-54	x	1183	LT2644D	01 02 27 49
	2+2x35-49		1483	LTA645	01 02 27 49
	2+2x35-49	x	1483	LTA645D	01 02 27 49
	2+2x80		1483	LTA646	01 02 27 49
	4+4x21-39		1758	LTA648	01 02 27 49
	4+4x21-39	x	1758	LTA648D	01 02 27 49
	4+4x28-54		2358	LT2649	01 02 27 49
	4+4x28-54	x	2358	LT2649D	01 02 27 49
	4+4x35-49		2958	LTA650	01 02 27 49
	4+4x35-49	x	2958	LTA650D	01 02 27 49
	4+4x80		2958	LTA651	01 02 27 49

A<sup>+</sup>-A

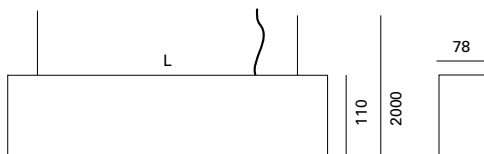

01 - bianco - white - bianco

02 - nero - black - negro

27 - ossidato alluminio - oxidised aluminium - oxidado aluminio

49 - moka - moka - moka



# FILE 2H SOSPENSIONE LED BI-EMISSIONE CON DIFFUSORE MICROPRISMATICO\*

LED DOUBLE EMISSION WITH MICROPRISMATIC DIFFUSER- LED BI-EMISIÓN CON DIFUSOR MICROPRISMATICO



	W	K	lm product	lm/Led	CRI	DaliT&D	Lmm	CODE	Col.
LINEAR LED 24W/MT 2200LM/MT CRI>80	2x19,2	3000	2592	3696	>80		860	LTC630X	01 02 27 49
	2x19,2	3000	2592	3696	>80	x	860	LTC630XD	01 02 27 49
	2x25,6	3000	3456	4928	>80		1140	LTC631X	01 02 27 49
	2x25,6	3000	3456	4928	>80	x	1140	LTC631XD	01 02 27 49
	2x32	3000	4320	6160	>80		1420	LTC632X	01 02 27 49
	2x32	3000	4320	6160	>80	x	1420	LTC632XD	01 02 27 49
	2x38,4	3000	5184	7392	>80		1700	LTC633X	01 02 27 49
	2x38,4	3000	5184	7392	>80	x	1700	LTC633XD	01 02 27 49
	2x44,8	3000	6048	8624	>80		1985	LTC634X	01 02 27 49
	2x44,8	3000	6048	8624	>80	x	1985	LTC634XD	01 02 27 49
	2x51,2	3000	6912	9856	>80		2265	LTC635X	01 02 27 49
	2x51,2	3000	6912	9856	>80	x	2265	LTC635XD	01 02 27 49
	2x57,6	3000	7776	11088	>80		2545	LTC636X	01 02 27 49
	2x57,6	3000	7776	11088	>80	x	2545	LTC636XD	01 02 27 49
	2x64	3000	8640	12320	>80		2825	LTC637X	01 02 27 49
	2x64	3000	8640	12320	>80	x	2825	LTC637XD	01 02 27 49

50000h Ta 25°  
L70B10



PER LA VERSIONE 4000K VEDI CODICI .4 A LISTINO | FOR 4000K VERSION SEE CODE .4 ON PRICELIST | POR LA VERSIÓN 4000K VER CODIGO .4 EN LA LISTA DE PRECIOS.

# FLUO BI-EMISSIONE CON DIFFUSORE MICROPRISMATICO\*

FLUO DOUBLE EMISSION WITH MICROPRISMATIC DIFFUSER- FLUO BI-EMISIÓN CON DIFUSOR MICROPRISMATICO

	W	DaliT&D	Lmm	CODE	Col.
T16 G5 230V	1+1x21-39		883	LT2630X	01 02 27 49
	1+1x21-39	x	883	LT2630XD	01 02 27 49
	1+1x28-54		1183	LT2632X	01 02 27 49
	1+1x28-54	x	1183	LT2632XD	01 02 27 49
	1+1x35-49-80		1483	LT2634X	01 02 27 49
	1+1x35-49-80	x	1483	LT2634XD	01 02 27 49
	2+2x21-39		1758	LTA636X	01 02 27 49
	2+2x21-39	x	1758	LTA636XD	01 02 27 49
	2+2x28-54		2358	LT2637X	01 02 27 49
	2+2x28-54	x	2358	LT2637XD	01 02 27 49
	2+2x35-49		2958	LTA638X	01 02 27 49
	2+2x35-49	x	2958	LTA638XD	01 02 27 49
	2+2x80		2958	LTA639X	01 02 27 49



# BI FLUO BI-EMISSIONE CON DIFFUSORE MICROPRISMATICO\*

DOUBLE-LAMP FLUO DOUBLE-EMISSION WITH MICROPRISMATIC DIFFUSER- BI FLUO BI-EMISIÓN CON DIFUSOR MICROPRISMATICO

	W	DaliT&D	Lmm	CODE	Col.
T16 G5 230V	2+2x21-39		883	LT2642X	01 02 27 49
	2+2x21-39	x	883	LT2642XD	01 02 27 49
	2+2x28-54		1183	LT2644X	01 02 27 49
	2+2x28-54	x	1183	LT2644XD	01 02 27 49
	2+2x35-49		1483	LTA645X	01 02 27 49
	2+2x35-49	x	1483	LTA645XD	01 02 27 49
	2+2x80		1483	LTA646X	01 02 27 49
	4+4x21-39		1758	LTA648X	01 02 27 49
	4+4x21-39	x	1758	LTA648XD	01 02 27 49
	4+4x28-54		2358	LT2649X	01 02 27 49
	4+4x28-54	x	2358	LT2649XD	01 02 27 49
	4+4x35-49		2958	LTA650X	01 02 27 49
	4+4x35-49	x	2958	LTA650XD	01 02 27 49
	4+4x80		2958	LTA651X	01 02 27 49



Su richiesta versioni Emergenza | Emergency versions on request | Emergencia versiones bajo demanda

\* DIFFUSORE MICROPRISMATICO A LUMINANZA CONTROLLATA (CONFORME NORMATIVA EN 12464-1) - CONTROLLED LUMINANCE MICROPRISMATIC DIFFUSER (CONFORMS TO STANDARD EN 12464-1) - DIFUSOR MICROPRISMATICO A LUMINANCA CONTROLADA (SEGUN EN 12464-1)

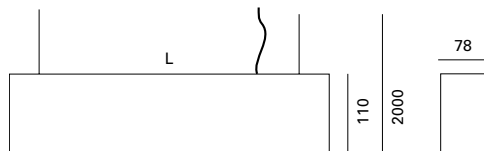

## FILE 2H SOSPENSIONE MONO FLUO BI-EMISSIONE CON DARKLIGHT\*

SINGLE-LAMP FLUO DOUBLE-EMISSION WITH DARKLIGHT- MONO FLUO BI-EMISION CON DARKLIGHT



T16	W	DaliT&D	Lmm	CODE	Col.
	1+1x21-39		883	LT2630K	01 02 27 49
	1+1x21-39	x	883	LT2630KD	01 02 27 49
	1+1x28-54		1183	LT2632K	01 02 27 49
	1+1x28-54	x	1183	LT2632KD	01 02 27 49
	1+1x35-49-80		1483	LT2634K	01 02 27 49
	1+1x35-49-80	x	1483	LT2634KD	01 02 27 49
	2+2x21-39		1758	LTA636K	01 02 27 49
	2+2x21-39	x	1758	LTA636KD	01 02 27 49
	2+2x28-54		2358	LT2637K	01 02 27 49
	2+2x28-54	x	2358	LT2637KD	01 02 27 49
	2+2x35-49		2958	LTA638K	01 02 27 49
	2+2x35-49	x	2958	LTA638KD	01 02 27 49
	2+2x80		2958	LTA639K	01 02 27 49

Su richiesta versioni Emergenza | Emergency versions on request | Emergencia versiones bajo demanda



## BI FLUO BI-EMISSIONE CON DARKLIGHT\*

DOUBLE-LAMP FLUO BI-EMISSION WITH DARKLIGHT- BI FLUO BI-EMISION CON DARKLIGHT

T16	W	DaliT&D	Lmm	CODE	Col.
	2+2x21-39		883	LT2642K	01 02 27 49
	2+2x21-39	x	883	LT2642KD	01 02 27 49
	2+2x28-54		1183	LT2644K	01 02 27 49
	2+2x28-54	x	1183	LT2644KD	01 02 27 49
	2+2x35-49		1483	LTA645K	01 02 27 49
	2+2x35-49	x	1483	LTA645KD	01 02 27 49
	2+2x80		1483	LTA646K	01 02 27 49
	4+4x21-39		1758	LTA648K	01 02 27 49
	4+4x21-39	x	1758	LTA648KD	01 02 27 49
	4+4x28-54		2358	LT2649K	01 02 27 49
	4+4x28-54	x	2358	LT2649KD	01 02 27 49
	4+4x35-49		2958	LTA650K	01 02 27 49
	4+4x35-49	x	2958	LTA650KD	01 02 27 49
	4+4x80		2958	LTA651K	01 02 27 49

Su richiesta versioni Emergenza | Emergency versions on request | Emergencia versiones bajo demanda



\*RIFLETTORE A LUMINANZA CONTROLLATA (CONFORME NORMATIVA EN 12464-1) - CONTROLLED LUMINANCE REFLECTOR (CONFORMS TO STANDARD EN 12464-1) - REFLECTORE A LUMINANCIA CONTROLADA (SEGÚN EN 12464-1)

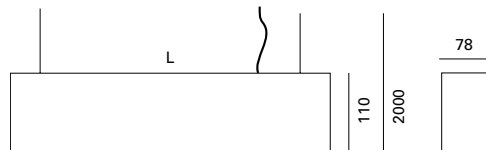



COMPLESSO EX MULINI PANTANELLA ROMA - ITALY  
LIGHTING PROJECT R.PARACIANI  
PHOTO ER STUDIO

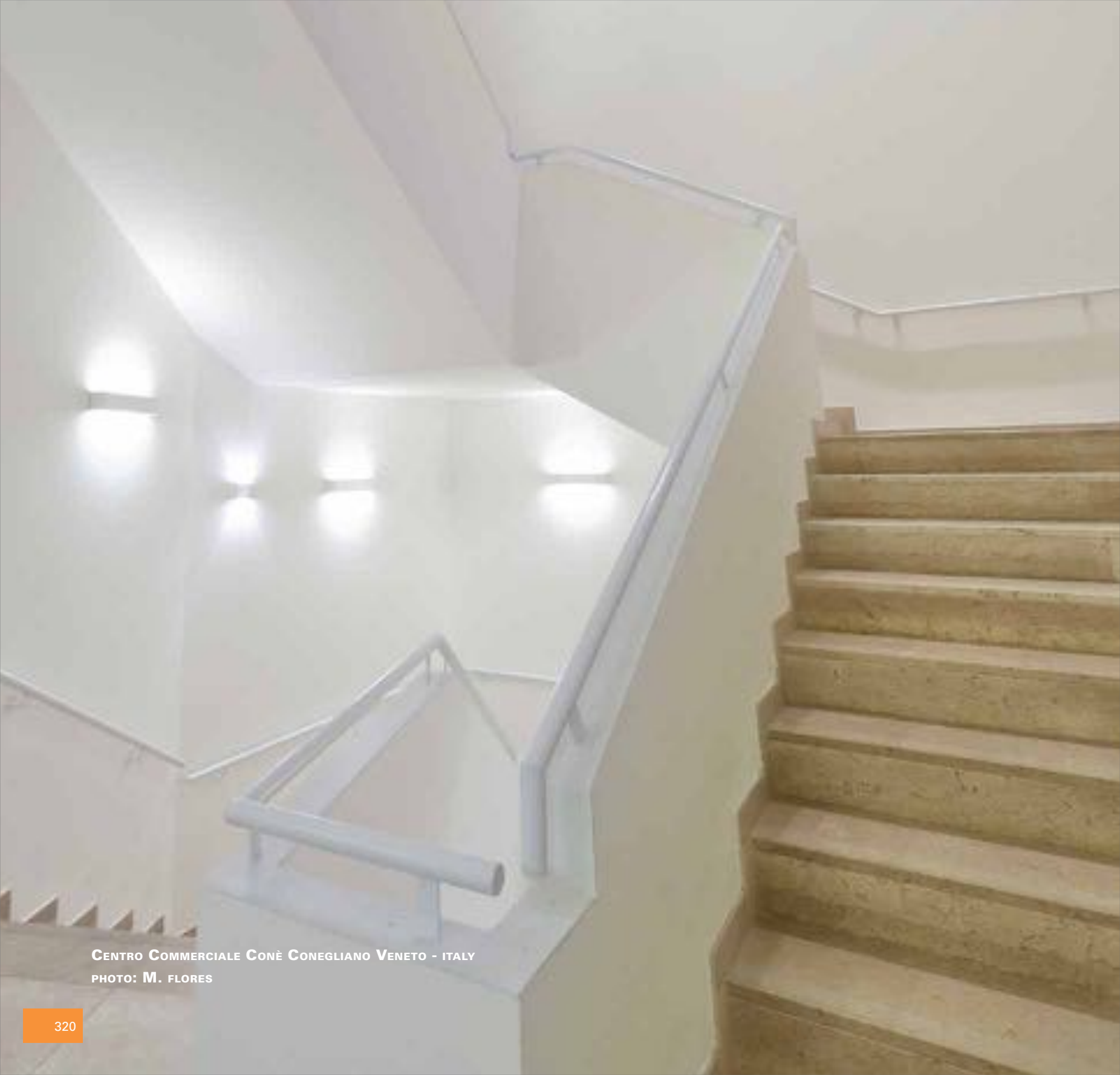

CENTRO COMMERCIALE CONÈ CONEGLIANO VENETO - ITALY  
PHOTO: M. FLORES

## FILE 2H PARETE LED BI-EMISSIONE CON DIFFUSORE OPALINO

LED DOUBLE EMISSION WITH OPALINE DIFFUSER- LED BI-EMISSION CON DIFUSOR OPALINO



LINEAR LED 24W/MT 2200lm/MT CRI>80	W	K	lm product	lm/Led	CRI	DalIT&D	Lmm	CODE	Col.
	2x19,2	3000	2208	3696	>80		860	LTC6H1	01 02 27 49
	2x19,2	3000	2208	3696	>80	x	860	LTC6H1D	01 02 27 49
	2x25,6	3000	2944	4928	>80		1140	LTC6H2	01 02 27 49
	2x25,6	3000	2944	4928	>80	x	1140	LTC6H2D	01 02 27 49
	2x32	3000	3681	6160	>80		1420	LTC6H3	01 02 27 49
	2x32	3000	3681	6160	>80	x	1420	LTC6H3D	01 02 27 49
	2x38,4	3000	4417	7392	>80		1700	LTC6H4	01 02 27 49
	2x38,4	3000	4417	7392	>80	x	1700	LTC6H4D	01 02 27 49
	2x44,8	3000	5153	8624	>80		1985	LTC6H5	01 02 27 49
	2x44,8	3000	5153	8624	>80	x	1985	LTC6H5D	01 02 27 49
	2x51,2	3000	5889	9856	>80		2265	LTC6H7	01 02 27 49
	2x51,2	3000	5889	9856	>80	x	2265	LTC6H7D	01 02 27 49
	2x57,6	3000	6625	11088	>80		2545	LTC6H8	01 02 27 49
	2x57,6	3000	6625	11088	>80	x	2545	LTC6H8D	01 02 27 49
	2x64	3000	7361	12320	>80		2825	LTC6H9	01 02 27 49
	2x64	3000	7361	12320	>80	x	2825	LTC6H9D	01 02 27 49

50000h Ta 25°  
L70B10

**A+**

IP40 CE (A)

Su richiesta disponibile la versione 4000°K | On request available 4000°K version | Versión con 4000°K demanda

## FLUO BI-EMISSIONE CON DIFFUSORE OPALINO

SINGLE-LAMP FLUO DOUBLE-EMISSION WITH OPALINE DIFFUSER- FLUO BI-EMISSION CON DIFUSOR OPALINO

T16	W	Lmm	CODE	Col.
	1+1x21-39	883	LT26H1	01 02 27 49
	1+1x28-54	1183	LT26H2	01 02 27 49
	1+1x35-49-80	1483	LT26H3	01 02 27 49
	2+2x28-54	2358	LT26H4	01 02 27 49
	2+2x35-49	2958	LTA6H5	01 02 27 49
	2+2x80	2958	LTB6H5	01 02 27 49

**A++-A**

IP40 CE (A)

Su richiesta versioni Emergenza | Emergency versions on request | Emergencia bajo demanda

## BI FLUO BI-EMISSIONE CON DIFFUSORE OPALINO

DOUBLE-LAMP FLUO DOUBLE-EMISSION WITH OPALINE DIFFUSER- BI FLUO BI-EMISSION CON DIFUSOR OPALINO

T16	W	Lmm	CODE	Col.
	2+2x21-39	883	LT26H6	01 02 27 49
	2+2x28-54	1183	LT26H7	01 02 27 49
	2+2x35-49	1483	LTA6H8	01 02 27 49
	2+2x80	1483	LTB6H8	01 02 27 49
	4+4x21-39	1758	LTA6H6	01 02 27 49
	4+4x28-54	2358	LT26H9	01 02 27 49
	4+4x35-49	2958	LTA6H10	01 02 27 49

**A++-A**

IP40 CE (A)

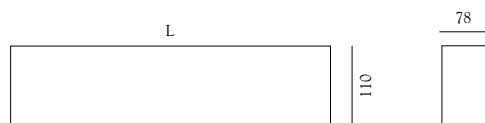

01 - bianco - white - bianco    02 - nero - black - negro    27 - ossidato alluminio - oxidised aluminium - oxidado aluminio    49 - moka - moka - moka

Sistema modulare per illuminazione diretta, diffusa e/o d'accento, composto da profili vuoti in estruso di alluminio verniciato o anodizzato 110x78 mm. di lunghezza predefinita o tagliabili a misura, disponibili nelle versioni a parete e sospensione. Da integrare con sorgenti lineari LED, reglette per lampade fluorescenti T16, incassi con sorgente LED integrata o per lampade alogene/LED QPAR16 e moduli binario max 16A 3 accensioni per inserimento di proiettori. Reglette fluorescenti complete di alimentazione elettronica 50/60Hz 230/240V. Reglette LED con driver integrati. Da completare con le testate di chiusura laterali con sistema Light Proof, schermo diffondente in PC opalino bianco o microprismatico (conforme normativa EN 12464-1) profili di chiusura, di lunghezza predefinita o tagliabili a misura, o griglia dark-light in alluminio ad alta specularità e staffe di fissaggio o cavi di sospensione. Grado di protezione IP40.

Modular system for direct, diffused and/or accent lighting, consisting of hollow profiles made from 110x78 mm painted or anodised extruded aluminium, with a predefined length or cut to measure, available in the following versions: wall-mounted, suspended. To be integrated with LED linear light sources, battens for T16 fluorescent lamps, recessed versions with built-in LED source or for QPAR16 halogen/LED lamps and max 16A 3-circuit track modules for inclusion of projectors. Fluorescent battens, complete with 50/60 Hz 230/240 V electronic power supply. LED batten with driver included. To be completed with side end caps with Light Proof system, opal white or microprismatic PC diffusing screen (in accordance with EN 12464-1), closing profiles, with a predefined length or cut to measure, or dark-light aluminium grille with high specular qualities and mounting brackets or suspension cables. IP40 protection rating.

Sistema modular para la iluminación directa, difusa y/o concentrada. Compuesto de perfil vacío en estruso de aluminio barnizado o anodizado 110x78 mm. de largo predefinida o cortable a medida, disponible en la versiones de pared y suspensión. Preparados para fuentes luminosas lineales LED, regletas para lámparas fluorescentes T16, proyectores con fuente luminosa LED integrada o para lámparas halógenas/LED QPAR16 y rieles binarios máx. 16A 3 encendidos, para la colocación de proyectores. Regletas para lámparas fluorescentes con alimentación electrónica 50/60Hz 230/240V. Reglette LED con alimentador incluido. Se complementan con las tapas de cierre laterales con sistema Light Proof, difusor en PC blanco opal o micro prismático (conforme normativa EN 12464-1), perfil de cierre, de longitud predefinida o cortable a medida, o difusor dark-light en aluminio de gran luminosidad, soporte de fijación o cables de suspensión. Grado de protección IP40.



**FILE 2H SISTEMA**



ARKLAB STUDIO DI ARCHITETTURA IMOLA - ITALY  
 PROJECT ARKLAB  
 PHOTO T.INGHILESI



**PROFILO VUOTO SOSPENSIONE**

SUSPENSION EMPTY PROFILE - SUSPENSION PERFIL VACIO



Lmm	CODE	Col.
1000	LT2520.1000	01 02 27 49
2000	LT2520.2000	01 02 27 49
3000	LT2520.3000	01 02 27 49
.....	LT2520.misura*	01 02 27 49

  
**COPPIA DITESTATE DI CHIUSURA**

COUPLE OF CLOSURE HEADS- HEADS PAREJA DE TAPAS FINALES



CODE	Col.
LT2522	01 02 27 49

**PROFILO VUOTO SOSPENSIONE X**

X-SHAPED EMPTY PROFILE - PERFIL VACIO X



Dim.	CODE	Col.
560x640	LT2520.X	01 02 27 49

**PROFILO VUOTO SOSPENSIONE T**

T-SHAPED EMPTY PROFILE - PERFIL VACIO T



Dim.	CODE	Col.
560x358	LT2520.T	01 02 27 49

**PROFILO VUOTO SOSPENSIONE 90°**

90°-SHAPED EMPTY PROFILE - PERFIL VACIO 90°



Dim.	CODE	Col.
280x280	LT2520.90	01 02 27 49

\*Tramite questo codice è possibile ordinare il profilo in una lunghezza lineare non standard. Sostituire alla parola "misura" la lunghezza desiderata in mm. Per ordinare un profilo con una o entrambe le estremità tagliate ad angolo 45° aggiungere alla misura la lettera "D" (taglio Destro) o "S" (taglio Sinistro). Seguire istruzioni riportate a pag. 834. Per profili oltre i 3 mt e massimo 6 mt le condizioni di trasporto sono da concordare. || \*Through this code it's possible to order the profile in a not-standard linear length. Replace the word "misura" with the desired length in mm. To order a profile with one or both ends 45° angle-cut add the letter "D" (right cut) or "S" (left cut) to the standard or custom length. Follow the instructions on page 834. For lengths over 3 mt. to max. 6 mt. transport conditions to negotiate. || \*el uso de este código, se puede ordenar el perfil en un lineal longitud no estándar. Sustitúyase la palabra "medida" de la longitud en mm. Para pedir un perfil con uno o ambos extremos cortados en un ángulo de 45° a añadir a la medida de la letra "D" (derecha cortada) o "S" (izquierda cortada). Siga las instrucciones de la página. 834. Perfiles para más de 3 my 6 m Condiciones máximas de transporte a convenir.

□ 01 - bianco - white - bianco    ■ 02 - nero - black - negro    □ 27 - ossidato alluminio - oxidised aluminium - oxidado aluminio    ■ 49 - moka - moka - moka

## KIT SOSPENSIONE IN ACCIAIO

STEEL SUSPENSION KIT- KIT DE SUSPENSION EN ACERO



Lmm	CODE
2000	<b>LT2519</b>
4000	<b>LT2519.4</b>

1 ogni 2 metri lineari + 1 | 1 every 2 meters + 1 | 1 cada 2 metros + 1

## KIT ALIMENTAZIONE COMPLETO DI ROSONE

POWER CABLE KIT WITH CEILING CANOPY- KIT ALIMENTACION CON FLORON



Dim.	Lmm	Kg	CODE	Col.
3X1	2000	0.18	<b>LT2411</b>	<b>01</b>
3X1	4000	0.36	<b>LT2411.4000</b>	<b>01</b>
4X1	2000	0.26	<b>LT2412</b>	<b>01</b>
4X1	4000	0.52	<b>LT2412.4000</b>	<b>01</b>
5X1	2000	0.30	<b>LT2412.5</b>	<b>01</b>
5X1	4000	0.60	<b>LT2412.5.4000</b>	<b>01</b>
7X1	2000	0.30	<b>LT2412.7</b>	<b>01</b>
7X1	4000	0.60	<b>LT2412.7.4000</b>	<b>01</b>
9X1	2000	0.30	<b>LT2412.9</b>	<b>01</b>
9X1	4000	0.60	<b>LT2412.9.4000</b>	<b>01</b>

## PROFILO VUOTO PARETE

WALL EMPTY PROFILE- PERFIL VACIO



Lmm	CODE	Col.
1000	<b>LTA520.1000</b>	<b>01 02 27 49</b>
2000	<b>LTA520.2000</b>	<b>01 02 27 49</b>
3000	<b>LTA520.3000</b>	<b>01 02 27 49</b>
.....	<b>LTA520.misura*</b>	<b>01 02 27 49</b>

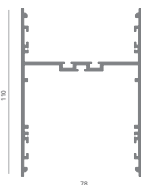

## COPPIA DITESTATE DI CHIUSURA

COUPLE OF CLOSURE HEADS - PAREJA DE TAPAS FINALES



CODE	Col.
<b>LT2522</b>	<b>01 02 27 49</b>

## DISTANZIALE DA POSIZIONARE TRA PROFILO E PARETE

SINGLE SPACER TO PUT BETWEEN PROFILE AND WALL- ESPACIADOR INDIVIDUAL PARA SER COLOCADO ENTRE EL PERFIL Y LA PARED



CODE
<b>LTX001</b>

Uno ogni 1/1,5mt | one every 1/1,5 mt | uno cada 1/1,5 mt

**REGLETTE LED 24 W/MT**

24W/MT LED BATTEN- REGLETTE LED 24W/MT LINEAR LED

	W	K	lm product	lm/Led	CRI	DaliT&D	Lmm	CODE	
 <p>LINEAR LED 24W/MT 2200lm/MT CRI&gt;80 230V</p>	12,8	3000	1232	1232	>80		560	RL23M01	
	12,8	3000	1232	1232	>80	x	560	RL23M01D	
	19,2	3000	1848	1848	>80		840	RL23M02	
	19,2	3000	1848	1848	>80	x	840	RL23M02D	
	25,6	3000	2464	2464	>80		1120	RL23M03	
	25,6	3000	2464	2464	>80	x	1120	RL23M03D	
	32	3000	3080	3080	>80		1400	RL23M04	
	32	3000	3080	3080	>80	x	1400	RL23M04D	
	38,4	3000	3696	3696	>80		1680	RL23M05	
	38,4	3000	3696	3696	>80	x	1680	RL23M05D	
	51,2	3000	4928	4928	>80		2240	RL23M07	
	51,2	3000	4928	4928	>80	x	2240	RL23M07D	
	50000h Ta 25° L70B10								
	A+								

  

	W	K	lm product	lm/Led	CRI	DaliT&D	Lmm	CODE	
 <p>LINEAR LED 24W/MT 2285lm/MT CRI&gt;80</p>	12,8	4000	1280	1280	>80		560	RL24M01	
	12,8	4000	1280	1280	>80	x	560	RL24M01D	
	19,2	4000	1920	1920	>80		840	RL24M02	
	19,2	4000	1920	1920	>80	x	840	RL24M02D	
	25,6	4000	2560	2560	>80		1120	RL24M03	
	25,6	4000	2560	2560	>80	x	1120	RL24M03D	
	32	4000	3200	3200	>80		1406	RL24M04	
	32	4000	3200	3200	>80	x	1406	RL24M04D	
	38,4	4000	3840	3840	>80		1680	RL24M05	
	38,4	4000	3840	3840	>80	x	1680	RL24M05D	
	51,2	4000	5120	5120	>80		2240	RL24M07	
	51,2	4000	5120	5120	>80	x	2240	RL24M07D	
	50000h Ta 25° L70B10								
	A+								

alimentatore incluso | included ballast | con trasformador

**REGLETTE LED 41 W/MT CRI>90**

CRI&gt;90 41 W/MT LED BATTEN - REGLETTE LED 41 W/MT CRI&gt;90

	W	K	lm product	lm/Led	CRI	DaliT&D	Lmm	CODE	
 <p>LINEAR LED 41W/MT 4640lm/MT CRI90</p>	22,8	3000	2600	2600	90		560	RL23H01	
	22,8	3000	2600	2600	90	x	560	RL23H01D	
	34,2	3000	3900	3900	90		840	RL23H02	
	34,2	3000	3900	3900	90	x	840	RL23H02D	
	45,6	3000	5200	5200	90		1120	RL23H03	
	45,6	3000	5200	5200	90	x	1120	RL23H03D	
	57	3000	6500	6500	90		1400	RL23H04	
	57	3000	6500	6500	90	x	1400	RL23H04D	
	68,4	3000	7800	7800	90		1680	RL23H05	
	68,4	3000	7800	7800	90	x	1680	RL23H05D	
	91,2	3000	10400	10400	90		2240	RL23H07	
	91,2	3000	10400	10400	90	x	2240	RL23H07D	
	A+								



  

	W	K	lm product	lm/Led	CRI	DaliT&D	Lmm	CODE	
 <p>LINEAR LED 41W/MT 4820lm/MT CRI90</p>	22,8	4000	2700	2700	90		560	RL24H01	
	22,8	4000	2700	2700	90	x	560	RL24H01D	
	34,2	4000	4050	4050	90		840	RL24H02	
	34,2	4000	4050	4050	90	x	840	RL24H02D	
	45,6	4000	5400	5400	90		1120	RL24H03	
	45,6	4000	5400	5400	90	x	1120	RL24H03D	
	57	4000	6750	6750	90		1400	RL24H04	
	57	4000	6750	6750	90	x	1400	RL24H04D	
	68,4	4000	8100	8100	90		1680	RL24H05	
	68,4	4000	8100	8100	90	x	1680	RL24H05D	
	91,2	4000	10800	10800	90		2240	RL24H07	
	91,2	4000	10800	10800	90	x	2240	RL24H07D	
	A+								

alimentatore incluso | included ballast | con trasformador

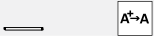

## REGLETTE DIRETTA MONO FLUO

SINGLE-LAMP FLUO BATTEN- REGLETTE DIRECTO MONO FLUO

	T16 G5 230V	W	DaliT&D	Lmm	CODE			
		14-24		575	LT2515.14-24			
		14-24	x	575	LT15.14-24D			
		21-39		875	LT2515.21-39			
		21-39	x	875	LT15.21-39D			
		28-54		1175	LT2515.28-54			
		28-54	x	1175	LT15.28-54D			
		35-49-80		1475	LT2515.35-49-80			
		35-49-80	x	1475	LT15.35-80D			
								

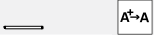

## REGLETTE BI FLUO

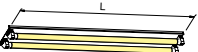
DOUBLE-LAMP FLUO BATTEN- REGLETTE BI FLUO

	T16 G5 230V	W	DaliT&D	Lmm	CODE	
		2x14-24		575	LT2516.14-24	
		2x14-24	x	575	LT16.14-24D	
		2x21-39		875	LT2516.21-39	
		2x21-39	x	875	LT16.21-39D	
		2x28-54		1175	LT2516.28-54	
		2x28-54	x	1175	LT16.28-54D	
		2x35-49		1475	LT16.35-49	
		2x35-49	x	1475	LT16.35-49D	
		2x80		1475	LT16.80	
						

## REGLETTE MONO FLUO OVERLAP LUCE CONTINUA

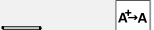
SINGLE-LAMP FLUO OVERLAP CONTINUOUS LIGHTING BATTEN- REGLETTE MONO FLUO OVERLAP LUZ CONTINUA

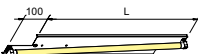
	T16	W	DaliT&D	Lmm	CODE			
		1x14-24		495+80 o 100	LT2514.14-24			
		1x14-24	x	495+80 o 100	LT14.14-24D			
		1x21-39		775+100	LT2514.21-39			
		1x21-39	x	775+100	LT14.21-39D			
		1x28-54		1075+100	LT2514.28-54			
		1x28-54	x	1075+100	LT14.28-54D			
		1x35-49-80		1375+100	LT2514.35-49-80			
		1x35-49-80	x	1375+100	LT14.35-49-80D			
								

Attenzione nel caso di utilizzo di sole reglette da 495mm la sovrapposizione da sommare sarà di 80mm | Attention in the case of use of 495mm battens only the overlap to be added will be 80mm, in the case of mixed combinations the overlap to be added will be of 100mm | Atención en el caso de uso de sol reglette 495mm añadir 80 mm para la superposición, en el caso de combinaciones mixtas la superposición ser añadido serán de 100mm.

## REGLETTE INDIRETTO LED 24W/MT LUCE INDIRETTA

INDIRECT EMISSION 24W/MT REGLETTE LED BATTEN - REGLETTE INDIRECTO LED 24W/MT

LINEAR LED 24W/MT 2200LM/MT CRI>80 230V	W	K	lm		CRI	Lmm	CODE	A	IP20
			product	lm/Led					
50000h Ta 25° L70B10	12,8	3000	1232	1232	>80	560	RLA23M01	A	IP20
	19,2	3000	1848	1848	>80	840	RLA23M02		
	25,6	3000	2464	2464	>80	1120	RLA23M03		
	32	3000	3080	3080	>80	1400	RLA23M04		
	38,4	3000	3696	3696	>80	1680	RLA23M05		
	51,2	3000	4928	4928	>80	2240	RLA23M07		

LINEAR LED 24W/MT 2285LM/MT CRI>80	W	K	lm		CRI	Lmm	CODE	A	IP20
			product	lm/Led					
50000h Ta 25° L70B10	12,8	4000	1280	1280	>80	560	RLA24M01	A	IP20
	19,2	4000	1920	1920	>80	840	RLA24M02		
	25,6	4000	2560	2560	>80	1120	RLA24M03		
	32	4000	3200	3200	>80	1400	RLA24M04		
	38,4	4000	3840	3840	>80	1680	RLA24M05		
	51,2	4000	5120	5120	>80	2240	RLA24M07		

## REGLETTE MONO FLUO LUCE CONTINUA INDIRETTA

INDIRECT EMISSION SINGLE-LAMP FLUO CONTINUOUS LIGHT BATTEN- REGLETTE MONO FLUO LUZ CONTINUA INDIRECTO



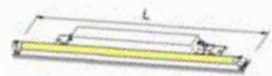

T16 G5 230V	W	DaliT&D	Lmm	CODE	A	IP20
14-24	495+80	LT21.14-24D				
21-39	775+100	LT2521.21-39				
21-39	775+100	LT21.21-39D				
28-54	1075+100	LT2521.28-54				
28-54	1075+100	LT21.28-54D				
35-49-80	1375+100	LT2521.35-49-80				
35-49-80	1375+100	LT21.35-49-80D				

Attenzione nel caso di utilizzo di sole reglette da 495mm la sovrapposizione da sommare sarà di 80mm, in caso di abbinamenti misti la sovrapposizione da sommare sarà di 100mm | Attention in the case of use of 495mm battens only the overlap to be added will be 80mm, in the case of mixed combinations the overlap to be added will be of 100mm | Atención en el caso de uso de sol reglette 495mm añadir 80 mm para la superposición, en el caso de combinaciones mixtas la superposición ser añadido serán de 100mm.





## MODULO SPOT

MODULO SPOT - SPOT MODULE- MÒDULO SPOT

	W	mA	K	Im product	Im/Led	CRI	∠	Lmm	CODE	Col.			
 <p>3SDCM 50000h L90 B10 ta 25°C</p> <p><b>A+</b></p>	6,8	350	2700	321	480	>90	24°	300	LT2506.927F	01 02			
	6,8	350	2700	437	480	>90	36°	300	LT2506.927W	01 02			
	6,8	350	3000	330	494	>90	24°	300	LT2506.930F	01 02			
	6,8	350	3000	450	494	>90	36°	300	LT2506.930W	01 02			
	2x6,8	350	2700	641	960	>90	24°	300	LT2507927F	01 02			
	2x6,8	350	2700	874	960	>90	36°	300	LT2507927W	01 02			
	2x6,8	350	3000	660	988	>90	24°	300	LT2507930F	01 02			
	2x6,8	350	3000	900	988	>90	36°	300	LT2507930W	01 02			
	3x6,8	350	2700	962	1440	>90	24°	300	LT2508.927F	01 02			
	3x6,8	350	2700	1312	1440	>90	36°	300	LT2508.927W	01 02			
	3x6,8	350	3000	990	1482	>90	24°	300	LT2508.930F	01 02			
	3x6,8	350	3000	1350	1482	>90	36°	300	LT2508.930W	01 02			
	<p>OPAR16 GU10 230V</p> 	1x50							300	LT2506		01 02	
		2x50							300	LT2507		01 02	
		3x50							300	LT2508		01 02	

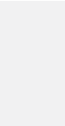

## STRIP BOBINA DA 5 METRI

STRIP LED 5 METERS ROLL- BOBINA STRIP LED 5 METROS

	W/mt	V	Led/mt	Im/mt	K	Im product	Im/W	CRI	IP	A	Lmm	Kg	CODE	
 <p>LINEAR LED 24V</p> <p><b>A+</b></p>	5,5	24	60	270	3000	1350	245	80	20	V.1	5000	0,18	ST05.30.5	
	9,6	24	120	540	3000	2700	281	80	20	V.1	5000	0,18	ST10.30.5	
	11	24	180	1200	3000	6000	545	80	20	V.1	5000	0,18	ST11.30.5	
	18	24	168	2200	3000	11000	611	80	20	V.1	5000	0,18	ST21.30.5	
<p>LINEAR LED IP65 24V</p> <p><b>A+</b></p>	9,6	24	120	540	3000	2700	281	80	65	V.1	5000	0,18	ST10.30.5IP	
	14,4	24	60	900	3000	4500	313	80	65	V.1	5000	0,18	ST15.30.5IP	
	19,2	24	240	1080	3000	5400	281	80	65	V.1	5000	0,18	ST20.30.5IP	



## DISSIPATORE DIRETTO PER STRIP LED

DIRECT EMISSION HEAT SINCK FOR STRIP LED- DISIPADOR DIRECTO PARA STRIP LED

	Lmm	CODE	
	1000	LTC2.1000	
	2000	LTC2.2000	
	3000	LTC2.3000	
	.....	LTC2.misura*	

## DISSIPATORE INDIRETTO PER STRIP LED

INDIRECT EMISSION HEAT SINCK FOR STRIP LED- DISIPADOR PARA STRIP LED

	Lmm	CODE	
	1000	LTC1.1000	
	2000	LTC1.2000	
	3000	LTC1.3000	
	.....	LTC1.misura*	

\*Tramite questo codice è possibile ordinare il profilo in una lunghezza lineare non standard. Sostituire alla parola "misura" la lunghezza desiderata in mm. Per profili oltre i 3 mt e massimo 6 mt le condizioni di trasporto sono da concordare. | \*Through this code it's possible to order the profile in a not-standard linear length. Replace the word "misura" with the desired length in mm. | \*el uso de este código, se puede ordenar el perfil en un lineal longitud no estándar. Sustitúyase la palabra "medida" de la longitud en mm. Perfiles para más de 3 my 6 m Condiciones máximas de transporte a convenir.

01 - bianco - white - blanco 02 - nero - black - negro

**FILE 2H SISTEMA DIFFUSORE IN POLICARBONATO OPALINO BIANCO**

OPAL WHITE POLYCARBONATE DIFFUSER- DIFUSOR OPALINO BLANCO EN POLICARBONATO



Lmm	CODE
1000	LT2506P1000
2000	LT2506P2000
3000	LT2506P3000
.....	LT2506Pmisura*

**FILE 2H SISTEMA DIFFUSORE IN POLICARBONATO MICROPRISMATICO\***

MICROPRISMATIC POLYCARBONATE DIFFUSER- DIFUSOR MICROPRISMATICO EN POLICARBONATO



Lmm	CODE
1000	LT2506X.1000
2000	LT2506X.2000
3000	LT2506X.3000
.....	LT2506X.misura*

\*DIFFUSORE MICROPRISMATICO A LUMINANZA CONTROLLATA (CONFORME NORMATIVA EN 12464-1) - CONTROLLED LUMINANCE MICROPRISMATIC DIFFUSER (CONFORMS TO STANDARD EN 12464-1) - DIFUSOR MICROPRISMATICO A LUMINANCIA CONTROLADA (SEGÚN EN 12464-1)

**FILE 2H SISTEMA RIFLETTORE DARK LIGHT\***

DARK LIGHT REFLECTOR- REFLECTOR DARK LIGHT



Lmm	CODE
874	LT2484
1174	LT2485
1474	LT2486

solo per reglette t16 | For t16 Batten only | solo por la reglette t16

\*RIFLETTORE A LUMINANZA CONTROLLATA (CONFORME NORMATIVA EN 12464-1) - CONTROLLED LUMINANCE REFLECTOR (CONFORMS TO STANDARD EN 12464-1) - REFLECTORE A LUMINANCIA CONTROLADA (SEGÚN EN 12464-1)

**PROFILO DI CHIUSURA IN ESTRUSO DI ALLUMINIO**

EXTRUDED ALUMINIUM CLOSING COVER- TAPA EN EXTRUSO DE ALUMINIO



Lmm	CODE	Col.
1000	LTT2.1000	01 02 27 49
2000	LTT2.2000	01 02 27 49
3000	LTT2.3000	01 02 27 49
.....	LTT2.misura*	01 02 27 49

\*Tramite questo codice è possibile ordinare il profilo in una lunghezza lineare non standard. Sostituire alla parola "misura" la lunghezza desiderata in mm. Per ordinare un profilo con una o entrambe le estremità tagliate ad angolo 45° aggiungere alla misura la lettera "D" (taglio Destro) o "S" (taglio Sinistro). Seguire istruzioni riportate a pag. 834. Per profili oltre i 3 mt e massimo 6 mt le condizioni di trasporto sono da concordare. || \*Through this code it's possible to order the profile in a not-standard linear length. Replace the word "misura" with the desired length in mm. To order a profile with one or both ends 45° angle-cut add the letter "D" (right cut) or "S" (left cut) to the standard or custom length. follow the instructions on page 834. for lengths over 3 mt. to max. 6 mt. transport conditions to negotiate. || \*el uso de este código, se puede ordenar el perfil en un lineal longitud no estándar. Sustitúyase la palabra "medida" de la longitud en mm. Para pedir un perfil con uno o ambos extremos cortados en un ángulo de 45° a añadir a la medida de la letra "D" (derecha cortada) o "S" (izquierda cortada). Siga las instrucciones de la página. 834. Perfiles para más de 3 my 6 m Condiciones máximas de transporte a convenir.

01 - bianco - white - bianco

02 - nero - black - negro

27 - ossidato alluminio - oxidised aluminium - oxidado aluminio

49 - moka - moka - moka



## COPPIA DI GIUNTI LINEARI

LINEAR CONNECTOR COUPLE- PAREJA DE CONECTORES LINEAL



CODE  
LT2523

## COPPIA DI GIUNTI ANGOLARI

ANGLE CONNECTOR COUPLE- PAREJA DE CONECTORES ANGULARES



CODE  
LT2523.90

## MODULO BINARIO EUROSTANDARD 230V ON/OFF - DALI - 1-10V

230V TRACK MODULE - MODULO CARRIL



Lmm	Kg	CODE	Col.
1000	0.92	LT25T.1000	01 02
2000	1.83	LT25T.2000	01 02
3000	2.75	LT25T.3000	01 02

da completare con gli accessori | To complete with accessories | Para completar con accesorios

## ALIMENTAZIONE DI TESTA DX

RIGHT HEAD FEED FOR TRACK SYSTEM- ALIMENTACIÓN DE CABECERA DERECHA TRACK SYSTEM

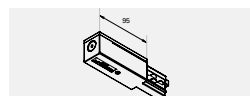

Possibilità di gestione separata di tre circuiti On/Off oppure di gestione tramite segnale digitale (DALI)

CODE	Col.
LT9020.1	01 02

## ALIMENTAZIONE DI TESTA SX

LEFT HEAD FEED FOR TRACK SYSTEM- ALIMENTACIÓN DE CABECERA IZQUIERDA TRACK SYSTEM

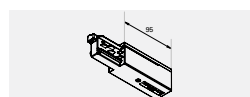

Possibilità di gestione separata di tre circuiti On/Off oppure di gestione tramite segnale digitale (DALI)

CODE	Col.
LT9021.1	01 02

## GIUNTO LINEARE

CONNECTOR FOR TRACK SYSTEM- UNIONES TRACK SYSTEM

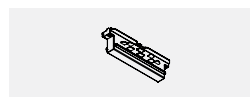

CODE	Col.
LT9023.1	01 02

## TAPPO DI CHIUSURA

BLIND END TRACK SYSTEM- TAPA DE CIERRE TRACK SYSTEM

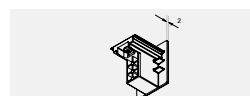

CODE	Col.
LT9033.1	01 02

## PARATIA DIVISORIA SINGOLA MODULO FLUO/BINARIO

INTERMEDIATE SINGLE HEAD FOR FLUO/ TRACK MODULE- TAPA SINGULO INTERMEDIO MODULO FLUO/CARRIL



CODE	Col.
LTRF2	01

01 - bianco - white - blanco 02 - nero - black - negro

VEDI PROIETTORI DA BINARIO - SEE PROJECTORS FOR TRACK - VER PROYECTORES POR CARRIL PAG. 574



---

Sistemi modulari da incasso rasato a scomparsa totale trimless per l'alloggiamento dei profili moduli sistema e moduli finiti MINIFLE, FILE o FILE2, FILE 2 Complementi, Leva e FARETÈN, per creare tagli di luce continua o in cui si alternano moduli luminosi a zone vuote, in controsoffitto o controparete di cartongesso o in muri di cemento o laterizio. Corpo in estruso di alluminio verniciato o anodizzato di lunghezza predefinita o tagliabile a misura. Da completare con le testate di chiusura laterali e con cover di rifinitura delle zone vuote in posizione arretrata a determinazione di un effetto di pieni e vuoti. Impiegabili inoltre con sorgenti lineari LED, da completare con schermo diffondente in PC opalino bianco e alimentatori remoti, per creare delle gole di luce arretrata.

Trimless, fully-retracting flush recessed modular systems for housing system profiles and MINIFILE, FILE, FILE 2, FILE 2 COMPLEMENTI, LEVA and FARETÈN finished modules for creating cuts of continuous light or where light modules alternate to voids, in plaster-board false-ceiling or false-walls or in concrete or brick walls. Painted or anodised extruded aluminium body, with a predefined length or cut to size. To be completed with side end caps and finishing cover for the empty spaces in a retracted position to determine an effect of solids and voids. Can also be used with LED linear light sources, to be completed with opal white PC diffusing screen and remote power supplies, to create retracted grooves of light.

Sistemas modulares totalmente empotrados "trimless" para la colocación de los perfiles y módulos acabados MINIFILE, FILE, FILE 2, FILE 2 COMPLEMENTI, LEVA y FARETÈN, para realizar cortes de luz continua o en los que se alternan módulos luminosos con zona vacías, en el falso techo y pared de cartón-yeso o y techos/paredes en ladrillo/cemento. Cuerpo en estruso aluminio barnizado o anodizado de longitud predefinida o cortable a medida. Se complementa con las tapas de cierre laterales y con tapas de acabado de las zonas vacías en posición retrasada para crear un efecto de lleno y vacío. Utilizable también con fuentes luminosas lineales LED, a completar con difusor en PC blanco opal y alimentadores remotos, para crear un efecto de luz interna.

---

**CONTAINER**





Concrete wall boxes and false-ceiling housings for  
Minifile, File, File2, Leva, Faretén







IDOM HEADQUARTER BILBAO - SPAIN  
PHOTO E. BIDERBOST





IDOM HEADQUARTER BILBAO - SPAIN  
PHOTO E. BIDERBOST





## SEZIONI PROFILO CONTAINER

CONTAINER MINIFILE

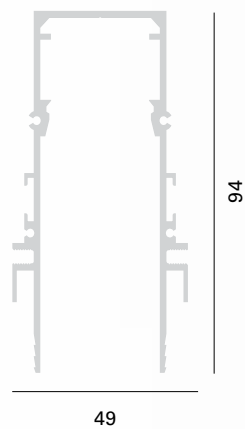

CONTAINER FILE

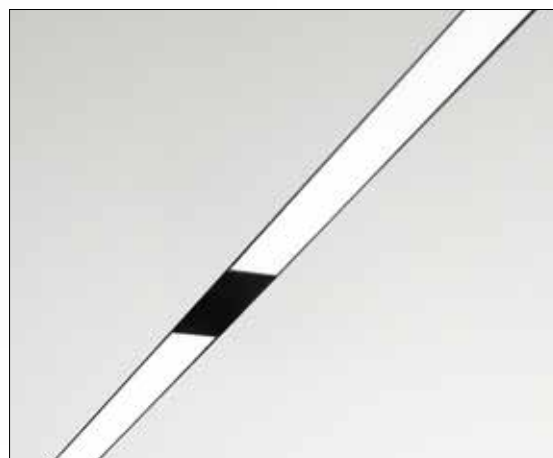
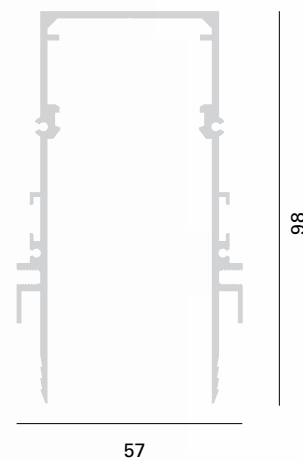

**CONTAINER FILE2**

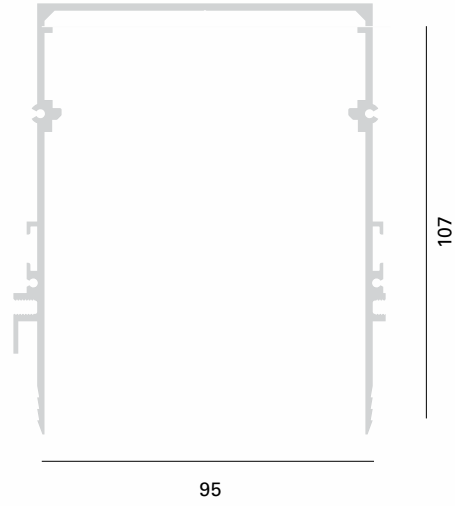

---

## CONTAINER SIMULATION



[WATCH THE VIDEO ON LUCIFEROS.COM](http://LUCIFEROS.COM)





Liberta' compositiva. Un contenitore di profili per creare la composizione desiderata tra moduli a luce continua e moduli spot, tra vuoti e pieni, tra ombra e luce.



Compositional freedom. A profile housing to create the desired composition between continuous light led or fluorescent modules and spot modules, between empty and full, shadow and light

## CONTAINER

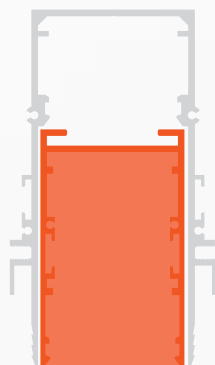

**Effetto notte.**

I container possono essere utilizzati anche per alloggiare strip led e relativo diffusore per ottenere un'illuminazione totalmente arretrata.

**Recessed effect.**

The container can be also used to host strip led and opal diffuser to create a total recessed lighting effect.

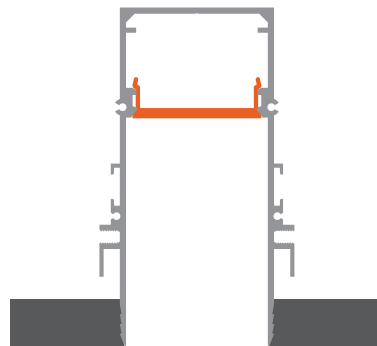

## CONTAINER MINIFILE

### CASSAFORMA/CONTAINER MINIFILE

MINIFILE WALLBOX- MINIFILE ENCOFRADO



Dim.	H	Lmm	CODE	Col.
49	94	1000	LTMF1000	01 02 27
49	94	2000	LTMF2000	01 02 27
49	94	3000	LTMF3000	01 02 27
49	94	.....	LTMFmisura*	01 02 27



### COPPIA DITESTATE

COUPLE OF CLOSURE HEADS TAPAS FINAL



CODE	Col.
LTM200	01 02 27

### CASSAFORMA GIUNTO X

X-SHAPED BRICK WALL/PLASTERBOARD EMPTY PROFILE- PERFIL VACIO LADRILLO/CARTON-YESO X



Dim.	CODE	Col.
595 x 565	LTMFX	01 02 27

### CASSAFORMA PARETE/SOFFITTO

WALL/CEILING EMPTY PROFILE - PERFIL VACIO PARED/TECHO



Dim.	CODE	Col.
280+94 x 280+94	LTMFPS	01 02 27

### CASSAFORMA GIUNTO 90°

90°-SHAPED BRICK WALL/PLASTERBOARD EMPTY PROFILE- PERFIL VACIO LADRILLO/CARTON-YESO 90°



Dim.	CODE	Col.
315 x 285	LTMF90	01 02 27

### CASSAFORMA GIUNTO T

T-SHAPED BRICK WALL/PLASTERBOARD EMPTY PROFILE - PERFIL VACIO LADRILLO/CARTON-YESO T



Dim.	CODE	Col.
565 x 315	LTMFT	01 02 27

\*Tramite questo codice è possibile ordinare il profilo in una lunghezza lineare non standard. Sostituire alla parola "misura" la lunghezza desiderata in mm. Per ordinare un profilo con una o entrambe le estremità tagliate ad angolo 45° aggiungere alla misura la lettera "D" (taglio Destro) o "S" (taglio Sinistro). Seguire istruzioni riportate a pag. 834. Per profili oltre i 3 mt e massimo 6 mt le condizioni di trasporto sono da concordare. || \*Through this code it's possible to order the profile in a not-standard linear length. Replace the word "misura" with the desired length in mm. To order a profile with one or both ends 45° angle-cut add the letter "D" (right cut) or "S" (left cut) to the standard or custom length. Follow the instructions on page 834. for lengths over 3 mt. to max. 6 mt. transport conditions to negotiate. || \*el uso de este código, se puede ordenar el perfil en un lineal longitud no estándar. Sustitúyase la palabra "medida" de la longitud en mm. Para pedir un perfil con uno o ambos extremos cortados en un ángulo de 45° a añadir a la medida de la letra "D" (derecha cortada) o "S" (izquierda cortada). Siga las instrucciones de la página. 834. Perfiles para más de 3 my 6 m Condiciones máximas de transporte a convenir.

01 - bianco - white - blanco 02 - nero - black - negro 27 - ossidato alluminio - oxidised aluminium - oxidado aluminio

## GIUNTI LINEARI COPPIA

LINEAR JOINT COUPLE FOR WALLBOX- CAJA PAREJA DE LINEAL UNION



CODE  
LTM211

## GIUNTI ANGOLARI COPPIA

ANGLE CONNECTORS COUPLE- CONNECTOR ANGULO PAREJA



CODE  
LTM211.90

## COPPIA DI STAFFE DI FISSAGGIO PER CARTONGESSO

COUPLE OF FIXING BRACKETS IN THE FALSE-CEILING - PAREJA DE SOPORTES PARA FIJACIÓN EN FALSO TECHO



CODE  
LTSC01

Coppia di staffe di fissaggio per cartongesso 1 ogni 1,5 mt. - couple of fixing brackets in the false-ceiling 1 per 0,5 mt. - pareja de soportes para fijación en falso techo 1 por 1,5 mt.

## STAFFA SINGOLA PER FISSAGGIO MODULO LUMINOSO LEVA SOFFITTO E MINIFILE SOFFITTO

LIGHTING MODULE LEVA CEILING & MINIFILE CEILING FIXING SINGLE BRACKET- SOPORTE INDIVIDUAL POR LEVA TECHO Y MINIFILE TECHO



CODE  
LTM210

staffa per fissaggio modulo luminoso all'interno della cassaforma. ordinare 1 al mt. (minimo 2 pezzi) | Single bracket to fix the lighting module within the wallbox, order 1 per mt. (min. 2 pcs) | soporte individual por fijar el encofrado, solicite 1 por mt. (2pcs mínimo)

## STAFFA SINGOLA PER LEVA ROTOTRASLANTE

LIGHTING MODULE LEVA ROTATE & SLIDE VERSION FIXING SINGLE BRACKET- SOPORTE INDIVIDUAL POR LEVA ROTOTRASLANTE



Lmm  
180

CODE  
LVKL01

## FASCETTA REGGICAVO PER CASSAFORMA

FASCETTA REGGICAVO- TIE CABLE LOCKING- ABRAZADERA DE CABLE



CODE  
LTSC02

Fascetta reggicavo - ordinare 1 ogni 0,5 mt (minimo 2pezzi) - Tie cable locking - order 1 per 0,5 mt. (min.2pcs) - Abrazadera de cable - solicite 1 por 0,5 mt. (2pcs mínimo)

**STRIP BOBINA DA 5 METRI**

STRIP LED 5 METERS ROLL- BOBINA STRIP LED 5 METROS

	W/mt	V	Led/ mt	lm/mt	K	lm product	lm/W	CRI	IP	A	Lmm	Kg	CODE
 LINEAR LED 24V <b>A+</b>	5,5	24	60	270	3000	1350	245	80	20	V.1	5000	0,18	ST05.30.5
	9,6	24	120	540	3000	2700	281	80	20	V.1	5000	0,18	ST10.30.5
	11	24	180	1200	3000	6000	545	80	20	V.1	5000	0,18	ST11.30.5
	18	24	168	2200	3000	11000	611	80	20	V.1	5000	0,18	ST21.30.5
LINEAR LED IP65 24V <b>A+</b>	9,6	24	120	540	3000	2700	281	80	65	V.1	5000	0,18	ST10.30.5IP
	14,4	24	60	900	3000	4500	313	80	65	V.1	5000	0,18	ST15.30.5IP
	19,2	24	240	1080	3000	5400	281	80	65	V.1	5000	0,18	ST20.30.5IP

**DIFFUSORE IN POLICARBONATO OPALINO BIANCO**

OPAL WHITE POLYCARBONATE DIFFUSER - DIFUSOR OPALINO BLANCO EN POLICARBONATO

	Lmm	CODE
	1000	LTM044.1000
	2000	LTM044.2000
	3000	LTM044.3000
	.....	LTM044.misura*

\*Tramite questo codice è possibile ordinare il profilo in una lunghezza lineare non standard. Sostituire alla parola "misura" la lunghezza desiderata in mm. Per ordinare un profilo con una o entrambe le estremità tagliate ad angolo 45° aggiungere alla misura la lettera "D" (taglio Destro) o "S" (taglio Sinistro). Seguire istruzioni riportate a pag. 834. Per profili oltre i 3 mt e massimo 6 mt le condizioni di trasporto sono da concordare. || \*Through this code it's possible to order the profile in a not-standard linear length. Replace the word "misura" with the desired length in mm. To order a profile with one or both ends 45° angle-cut add the letter "D" (right cut) or "S" (left cut) to the standard or custom length. Follow the instructions on page 834. For lengths over 3 mt. to max. 6 mt. transport conditions to negotiate. || \*el uso de este código, se puede ordenar el perfil en un lineal longitud no estándar. Sustitúyase la palabra "medida" de la longitud en mm. Para pedir un perfil con uno o ambos extremos cortados en un ángulo de 45 ° a añadir a la medida de la letra "D" (derecha cortada) o "S" (izquierda cortada). Siga las instrucciones de la página. 834. Perfiles para más de 3 my 6 m Condiciones máximas de transporte a convenir.

PER I MODULI LAMPADA DA INSERIRE NEL RELATIVO CONTAINER VEDERE LE SEZIONI SOTTO INDICATE  
FOR THE LIGHTING MODULES SEE THE CATALOGUE CHAPTERS BELOW REPORTED  
PARA LOS MÓDULOS DE LÁMPARA QUE SE DEBEN INCLUIR EN SU CONTAINER CONSULTE LAS SIGUIENTES SECCIONES.



MINIFILE SOFFITTO - CEILING - TECHO



LEVA SOFFITTO- CEILING - TECHO



LEVA ROTOTRALANTE - ROTATE & SLIDE VERSION



# CONTAINER FILE

## CASSAFORMA/CONTAINER FILE

WALLBOX- ENCOFRADO



Dim.	H	Lmm	CODE	Col.
57	98	1000	LTF1.1000	01 02 27
57	98	2000	LTF1.2000	01 02 27
57	98	3000	LTF1.3000	01 02 27
57	98	.....	LTF1.misura*	01 02 27



## CASSAFORMA GIUNTO X

X-SHAPED BRICKWALL/PLASTERBOARD EMPTY PROFILE- PERFIL VACIO LADRILLO/CARTON-YESO X



Dim.	CODE	Col.
600x570	LTF1.X	01 02 27

## CASSAFORMA GIUNTO 90

90°-SHAPED BRICKWALL/PLASTERBOARD EMPTY PROFILE- PERFIL VACIO LADRILLO/CARTON-YESO 90



Dim.	CODE	Col.
320x290	LTF1.90	01 02 27

## CASSAFORMA GIUNTO T

T-SHAPED BRICKWALL/PLASTERBOARD EMPTY PROFILE- PERFIL VACIO LADRILLO/CARTON-YESO T



Dim.	CODE	Col.
565x320	LTF1.T	01 02 27

## COPPIA DITESTATE

COUPLE OF CLOSURE HEADS TAPAS FINAL



CODE	Col.
LT2480	01 02 27

## CASSAFORMA PARETE/SOFFITTO

WALL/CEILINGEMPTY PROFILE - PERFIL VACIO PARED/TECHO



Dim.	CODE	Col.
280+98x 280+98	LTF1.PS	01 02 27

\*Tramite questo codice è possibile ordinare il profilo in una lunghezza lineare non standard. Sostituire alla parola "misura" la lunghezza desiderata in mm. Per ordinare un profilo con una o entrambe le estremità tagliate ad angolo 45° aggiungere alla misura la lettera "D" (taglio Destro) o "S" (taglio Sinistro). Seguire istruzioni riportate a pag. 834. Per profili oltre i 3 mt e massimo 6 mt le condizioni di trasporto sono da concordare. || \*Through this code it's possible to order the profile in a not-standard linear length. Replace the word "misura" with the desired length in mm. To order a profile with one or both ends 45° angle-cut add the letter "D" (right cut) or "S" (left cut) to the standard or custom length. follow the instructions on page 834. for lengths over 3 mt. to max. 6 mt. transport conditions to negotiate. || \*el uso de este código, se puede ordenar el perfil en un lineal longitud no estándar. Sustitúyase la palabra "medida" de la longitud en mm. Para pedir un perfil con uno o ambos extremos cortados en un ángulo de 45° a añadir a la medida de la letra "D" (derecha cortada) o "S" (izquierda cortada). Siga las instrucciones de la página. 834. Perfiles para más de 3 my 6 m Condiciones máximas de transporte a convenir.

01 - bianco - white - blanco 02 - nero - black - negro 27 - ossidato alluminio - oxidised aluminium - oxidado aluminio

## GIUNTI LINEARI COPPIA

LINEAR JOINT COUPLE FOR WALLBOX- CAJA PAREJA DE LINEAL UNION



CODE  
LT2482

## GIUNTI ANGOLARI COPPIA

ANGLE CONNECTORS COUPLE- CONNECTOR ANGULO PAREJA



CODE  
LTM211.90

## COPPIA DI STAFFE DI FISSAGGIO PER CARTONGESSO

COUPLE OF FIXING BRACKETS IN THE FALSE-CEILING - PAREJA DE SOPORTES PARA FIJACIÓN EN FALSO TECHO



Coppia di staffe di fissaggio per cartongesso 1 ogni 1,5 mt. - couple of fixing brackets in the false-ceiling 1 per 0,5 mt. - pareja de soportes para fijación en falso techo 1 por 1,5 mt.

CODE  
LTSC01

## STAFFA SINGOLA PER CASSAFORMA

SINGLE BRACKET- SOPORTE INDIVIDUAL



staffa per fissaggio modulo luminoso all'interno della cassaforma. ordinare 1 al mt. (minimo 2 pezzi) | Single bracket to Fix the lighting module within the wallbox, order 1 per mt. (min. 2 pcs) | soporte individual por fijar el encofrado, solicite 1 por mt. (2pcs mínimo)

CODE  
LT2481

## FASCETTA REGGICAVO PER CASSAFORMA

TIE CABLE LOCKING- ABRAZADERA DE CABLE



Fascetta reggicavo - ordinare 1 ogni 0,5 mt (minimo 2pezzi) - Tie cable locking - order 1 per 0,5 mt. (min.2pcs) - Abrazadera de cable - solicite 1 por 0,5 mt. (2pcs mínimo)

CODE  
LTSC03

**STRIP BOBINA DA 5 METRI**

STRIP LED 5 METERS ROLL- BOBINA STRIP LED 5 METROS



	W/mt	V	Led/ mt	lm/mt	K	lm product	lm/W	CRI	IP	A	Lmm	Kg	CODE
LINEAR LED 24V <b>A+</b>	5,5	24	60	270	3000	1350	245	80	20	V.1	5000	0,18	ST05.30.5
	9,6	24	120	540	3000	2700	281	80	20	V.1	5000	0,18	ST10.30.5
	11	24	180	1200	3000	6000	545	80	20	V.1	5000	0,18	ST11.30.5
	18	24	168	2200	3000	11000	611	80	20	V.1	5000	0,18	ST21.30.5
LINEAR LED IP65 24V <b>A+</b>	9,6	24	120	540	3000	2700	281	80	65	V.1	5000	0,18	ST10.30.5IP
	14,4	24	60	900	3000	4500	313	80	65	V.1	5000	0,18	ST15.30.5IP
	19,2	24	240	1080	3000	5400	281	80	65	V.1	5000	0,18	ST20.30.5IP

**DIFFUSORE IN POLICARBONATO OPALINO BIANCO**

OPAL WHITE POLYCARBONATE DIFFUSER- DIFUSOR OPALINO BLANCO EN POLICARBONATO



	Lmm	Kg	CODE
	1000	0.16	LT239P1000
	2000	0.33	LT239P2000
	3000	0.50	LT239P3000
	.....		LT239Pmisura*

\*Tramite questo codice è possibile ordinare il profilo in una lunghezza lineare non standard. Sostituire alla parola "misura" la lunghezza desiderata in mm. Per ordinare un profilo con una o entrambe le estremità tagliate ad angolo 45° aggiungere alla misura la lettera "D" (taglio Destro) o "S" (taglio Sinistro). Seguire istruzioni riportate a pag. 834. Per profili oltre i 3 mt e massimo 6 mt le condizioni di trasporto sono da concordare. | | \*Through this code it's possible to order the profile in a not-standard linear length. Replace the word "misura" with the desired length in mm. To order a profile with one or both ends 45° angle-cut add the letter "D" (right cut) or "S" (left cut) to the standard or custom length. follow the instructions on page 834. for lengths over 3 mt. to max. 6 mt. transport conditions to negotiate. | | \*el uso de este código, se puede ordenar el perfil en un lineal longitud no estándar. Sustitúyase la palabra "medida" de la longitud en mm. Para pedir un perfil con uno o ambos extremos cortados en un ángulo de 45 ° a añadir a la medida de la letra "D" (derecha cortada) o "S" (izquierda cortada). Siga las instrucciones de la página. 834. Perfiles para más de 3 my 6 m Condiciones máximas de transporte a convenir.

PER I MODULI LAMPADA DA INSERIRE NEL RELATIVO CONTAINER VEDERE LE SEZIONI SOTTO INDICATE  
FOR THE LIGHTING MODULES SEE THE CATALOGUE CHAPTERS BELOW REPORTED  
PARA LOS MÓDULOS DE LÁMPARA QUE SE DEBEN INCLUIR EN SU CONTAINER CONSULTE LAS SIGUIENTES SECCIONES.



**FILE SOFFITTO** - CEILING - TECHO.

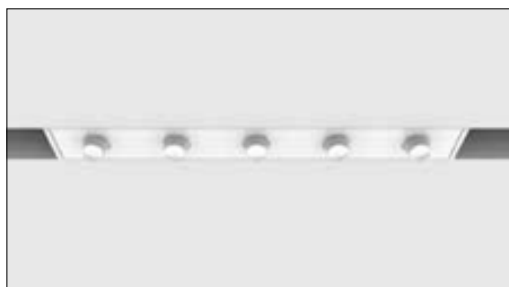

**FARETÈN** FILE MINISPOT



**FARETÈN** FILE FOCUS 41



**FARETÈN** FILE FOCUS 42

# CONTAINER FILE2

## CASSAFORMA/CONTAINER FILE2

WALLBOX- CAJA



Dim.	H	Lmm	CODE	Col.
95	107	1000	LTF2.1000	01 02 27
95	107	2000	LTF2.2000	01 02 27
95	107	3000	LTF2.3000	01 02 27
95	107	.....	LTF2.misura*	01 02 27

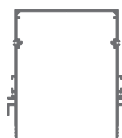

## COPPIA DITESTATE

COUPLE OF CLOSURE HEADS TAPAS FINAL



CODE	Col.
LT2890	01 02 27

## CASSAFORMA GIUNTO X

X-SHAPED BRICKWALL/PLASTERBOARD EMPTY PROFILE- PERFIL VACIO LADRILLO/CARTON-YESO X



Dim.	CODE	Col.
645 x 565	LTF2.X	01 02 27

## CASSAFORMA PARETE/SOFFITTO

WALL/CEILING EMPTY PROFILE - PERFIL VACIO PARED/TECHO



Dim.	CODE	Col.
280 +107 x 280+107	LTF2.PS	01 02 27

## CASSAFORMA GIUNTO 90°

90°-SHAPED BRICKWALL/PLASTERBOARD EMPTY PROFILE- PERFIL VACIO LADRILLO/CARTON-YESO 90°



Dim.	CODE	Col.
365 x 285	LTF2.90	01 02 27

## CASSAFORMA GIUNTO T

T-SHAPED BRICKWALL/PLASTERBOARD EMPTY PROFILE- PERFIL VACIO LADRILLO/CARTON-YESO T



Dim.	CODE	Col.
565 x 365	LTF2.T	01 02 27

\*Tramite questo codice è possibile ordinare il profilo in una lunghezza lineare non standard. Sostituire alla parola "misura" la lunghezza desiderata in mm. Per ordinare un profilo con una o entrambe le estremità tagliate ad angolo 45° aggiungere alla misura la lettera "D" (taglio Destro) o "S" (taglio Sinistro). Seguire istruzioni riportate a pag. 834. Per profili oltre i 3 mt e massimo 6 mt le condizioni di trasporto sono da concordare. || \*Through this code it's possible to order the profile in a not-standard linear length. Replace the word "misura" with the desired length in mm. To order a profile with one or both ends 45° angle-cut add the letter "D" (right cut) or "S" (left cut) to the standard or custom length. follow the instructions on page 834. for lengths over 3 mt. to max. 6 mt. transport conditions to negotiate. || \*el uso de este código, se puede ordenar el perfil en un lineal longitud no estándar. Sustitúyase la palabra "medida" de la longitud en mm. Para pedir un perfil con uno o ambos extremos cortados en un ángulo de 45 ° a añadir a la medida de la letra "D" (derecha cortada) o "S" (izquierda cortada). Siga las instrucciones de la página. 834. Perfiles para más de 3 my 6 m Condiciones máximas de transporte a convenir.

01 - bianco - white - blanco 02 - nero - black - negro

27 - ossidato alluminio - oxidised aluminium - oxidado aluminio

## GIUNTI LINEARI COPPIA

LINEAR JOINT COUPLE FOR WALLBOX- CAJA PAREJA DE LINEAL UNION



CODE  
LT2892

## GIUNTI ANGOLARI COPPIA

ANGLE CONNECTORS COUPLE- CONNECTOR ANGULO PAREJA



CODE  
LTV211.90

## COPPIA DI STAFFE DI FISSAGGIO PER CARTONGESSO

COUPLE OF FIXING BRACKETS IN THE FALSE-CEILING - PAREJA DE SOPORTES PARA FIJACIÓN EN FALSO TECHO



Coppia di staffe di fissaggio per cartongesso 1 ogni 1,5 mt. - couple of fixing brackets in the false-ceiling 1 per 0,5 mt. - pareja de soportes para fijación en falso techo 1 por 1,5 mt.

CODE  
LTSC01

## STAFFA SINGOLA PER FISSAGGIO MODULO LUMINOSO

+--SINGLE BRACKET- SOPORTE INDIVIDUAL



staffa per fissaggio modulo luminoso all'interno della cassaforma. ordinare 1 al mt. (minimo 2 pezzi) | Single bracket to Fix the lighting module within the wallbox, order 1 per mt. (min. 2 pcs) | soporte individual por fijar el encofrado, solicite 1 por mt. (2pcs mínimo)

CODE  
LT2891

## FASCETTA REGGICAVO PER CASSAFORMA

TIE CABLE LOCKING- ABRAZADERA DE CABLE



Fascetta reggicavo - ordinare 1 ogni 0,5 mt (minimo 2pezzi) - Tie cable locking - order 1 per 0,5 mt. (min.2pcs) - Abrazadera de cable - solicite 1 por 0,5 mt. (2pcs mínimo)

CODE  
LTSC04

**STRIP BOBINA DA 5 METRI**

STRIP LED 5 METERS ROLL- BOBINA STRIP LED 5 METROS



	W/mt	V	Led/ mt	lm/mt	K	lm product	lm/W	CRI	IP	A	Lmm	Kg	CODE
LINEAR LED 24V <b>A+</b>	5,5	24	60	270	3000	1350	245	80	20	V.1	5000	0,18	ST05.30.5
	9,6	24	120	540	3000	2700	281	80	20	V.1	5000	0,18	ST10.30.5
	11	24	180	1200	3000	6000	545	80	20	V.1	5000	0,18	ST11.30.5
	18	24	168	2200	3000	11000	611	80	20	V.1	5000	0,18	ST21.30.5
LINEAR LED IP65 24V <b>A+</b>	9,6	24	120	540	3000	2700	281	80	65	V.1	5000	0,18	ST10.30.5IP
	14,4	24	60	900	3000	4500	313	80	65	V.1	5000	0,18	ST15.30.5IP
	19,2	24	240	1080	3000	5400	281	80	65	V.1	5000	0,18	ST20.30.5IP

**DIFFUSORE IN POLICARBONATO OPALINO BIANCO**

OPAL WHITE POLYCARBONATE DIFFUSER- DIFUSOR OPALINO BLANCO EN POLICARBONATO

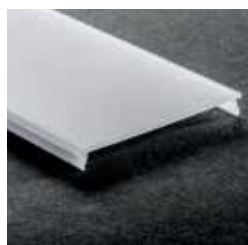

	Lmm	CODE
	1000	LT2506P1000
	2000	LT2506P2000
	3000	LT2506P3000
		LT2506Pmisura*

\*Tramite questo codice è possibile ordinare il profilo in una lunghezza lineare non standard. Sostituire alla parola "misura" la lunghezza desiderata in mm. Per ordinare un profilo con una o entrambe le estremità tagliate ad angolo 45° aggiungere alla misura la lettera "D" (taglio Destro) o "S" (taglio Sinistro). Seguire istruzioni riportate a pag. 834. Per profili oltre i 3 mt e massimo 6 mt le condizioni di trasporto sono da concordare. | | \*Through this code it's possible to order the profile in a not-standard linear length. Replace the word "misura" with the desired length in mm. To order a profile with one or both ends 45° angle-cut add the letter "D" (right cut) or "S" (left cut) to the standard or custom length. follow the instructions on page 834. for lengths over 3 mt. to max. 6 mt. transport conditions to negotiate. | | \*el uso de este código, se puede ordenar el perfil en un lineal longitud no estándar. Sustitúyase la palabra "medida" de la longitud en mm. Para pedir un perfil con uno o ambos extremos cortados en un ángulo de 45 ° a añadir a la medida de la letra "D" (derecha cortada) o "S" (izquierda cortada). Siga las instrucciones de la página. 834. Perfiles para más de 3 my 6 m Condiciones máximas de transporte a convenir.



PER I MODULI LAMPADA DA INSERIRE NEL RELATIVO CONTAINER VEDERE LE SEZIONI SOTTO INDICATE  
FOR THE LIGHTING MODULES SEE THE CATALOGUE CHAPTERS BELOW REPORTED  
PARA LOS MÓDULOS DE LÁMPARA QUE SE DEBEN INCLUIR EN SU CONTAINER CONSULTE LAS SIGUIENTES SECCIONES.



**FILE2** SOFFITTO - CEILING -TECHO



**FILE2** COMPLEMENTI



**LEVA2** SOFFITTO - CEILING -TECHO



**LEVA** BASCULANTE - TILT VERSION - BASCULANTE



**FARETÈN** FILE2 SPOT

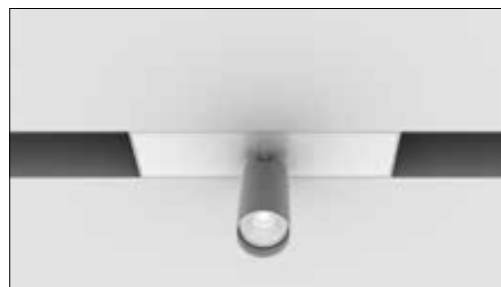

**FARETÈN** FILE2 FOCUS55

Apparecchi a parete o a plafone per illuminazione diretta o indiretta, per sorgenti lineari LED e STRIP LED. Da completare con alimentatore elettronico da installare remoto. Corpo in estruso di alluminio. Doppia possibilità di installazione: se fissati per il lato corto l'illuminazione è diffusa, se fissati per quello largo l'illuminazione è più radente. Completi di testate di chiusura laterali con sistema Light Proof, schermi diffondenti in PC opalino bianco e staffe di fissaggio. Grado di protezione IP40.

Series of wall or ceiling-mounted fixtures for direct or indirect lighting, for integrated linear LED sources or to be completed with LED strips. To be completed with driver, to be installed remote. Body in extruded aluminium. Double installation possibility: if fixed by the narrow side, the lighting effect is diffused, if fixed instead by the wide side, the lighting is grazing. Complete with Light Proof system side end caps, opal white PC diffuser and mounting brackets. IP40 degree of protection.

Aparatos de pared o plafón para iluminación directa o indirecta, para fuentes de luz lineales LED. Se debe completar con alimentador electrónico a instalar remoto. Cuerpo en estruso de aluminio, acabado barnizado. Doble posibilidad de instalación: si se fija por el lado estrecho (Flok) la iluminación es difuminada, si se fija por el lado ancho (flik) la iluminación es más directa. Van incluidas las tapas laterales con sistema "Light Proof", difusores en policarbonato opal blanco y soportes de fijación. Grado de protección IP40.

---

**FLIK - FLOK PARETE**

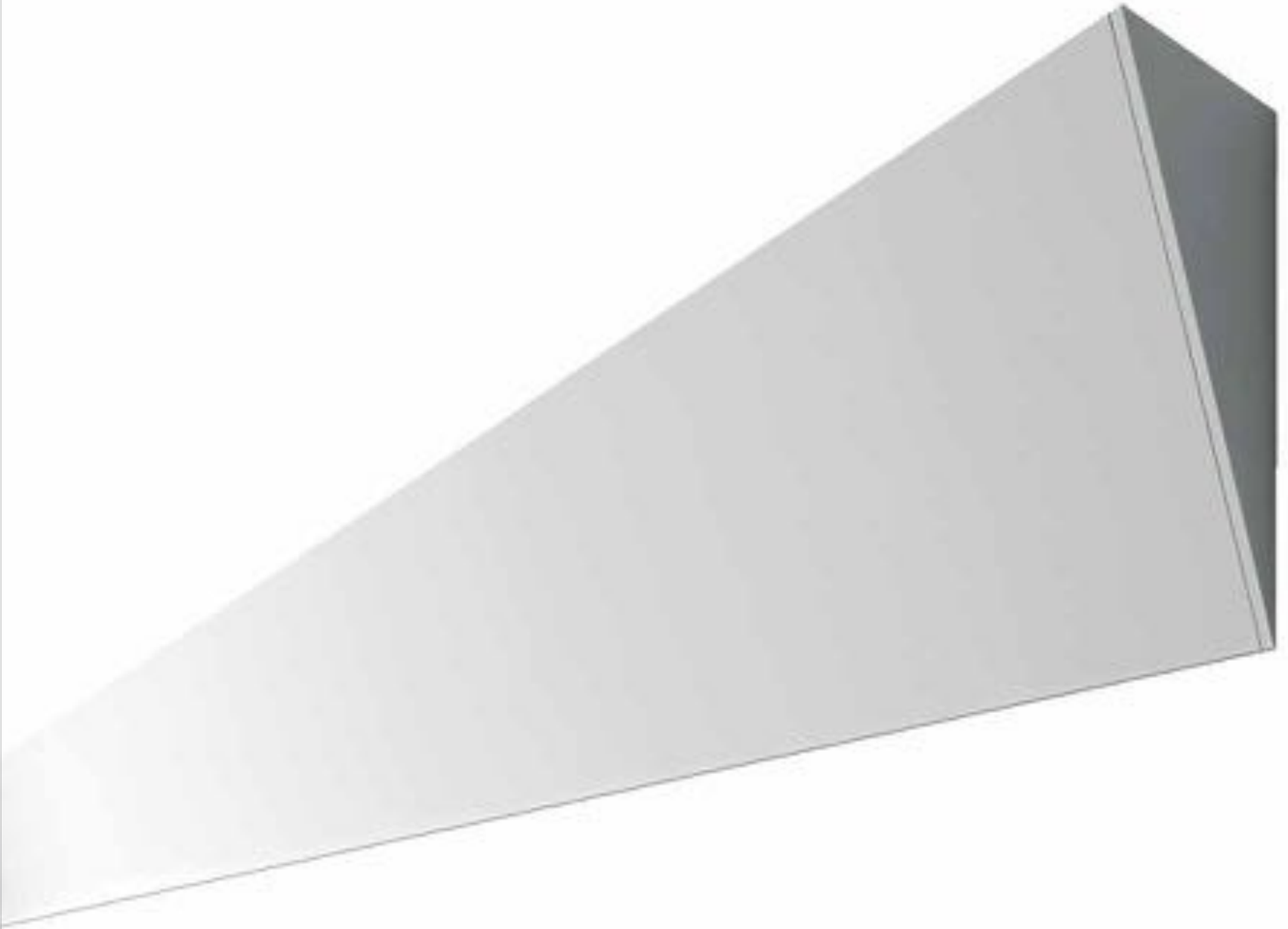

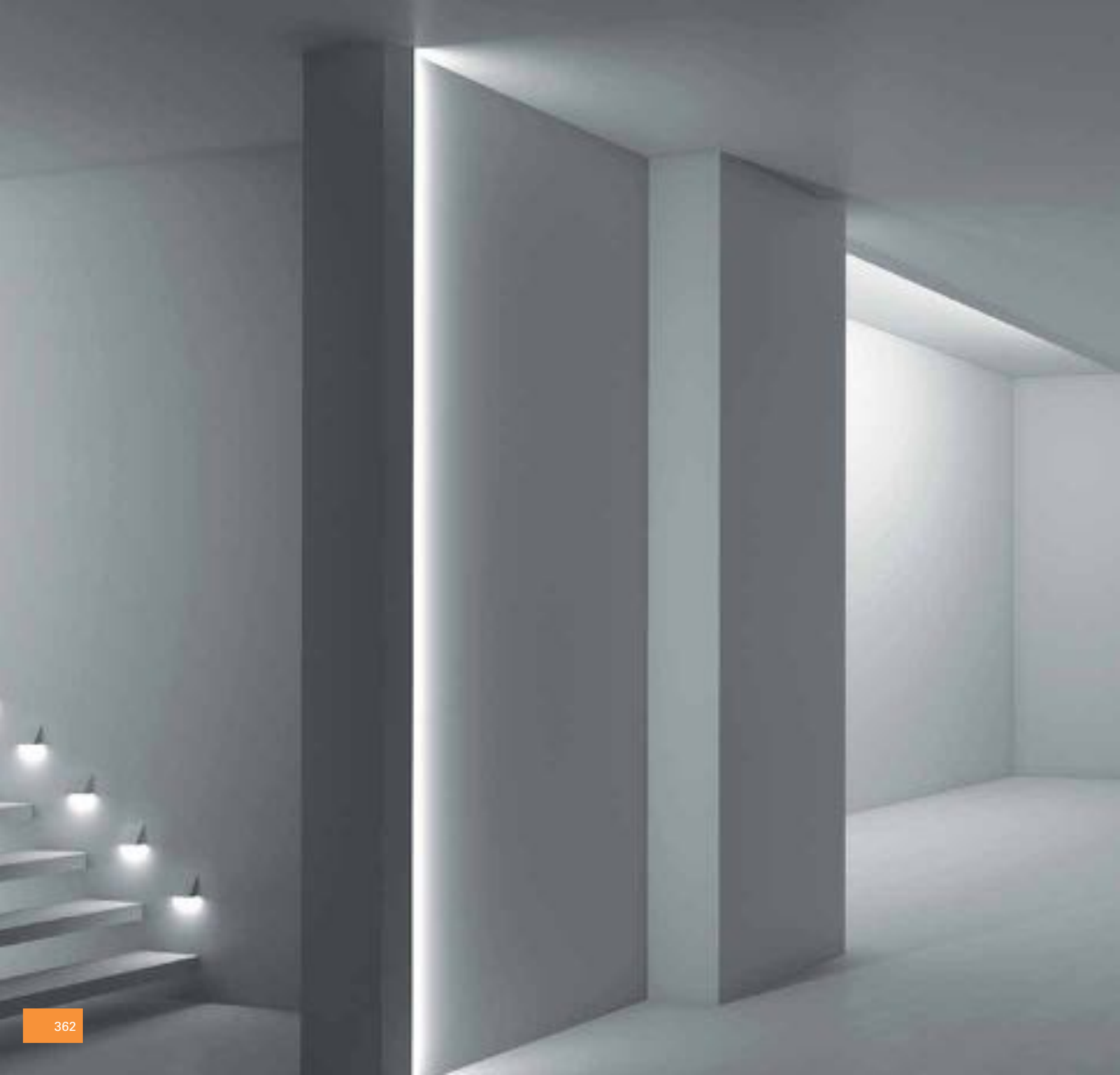

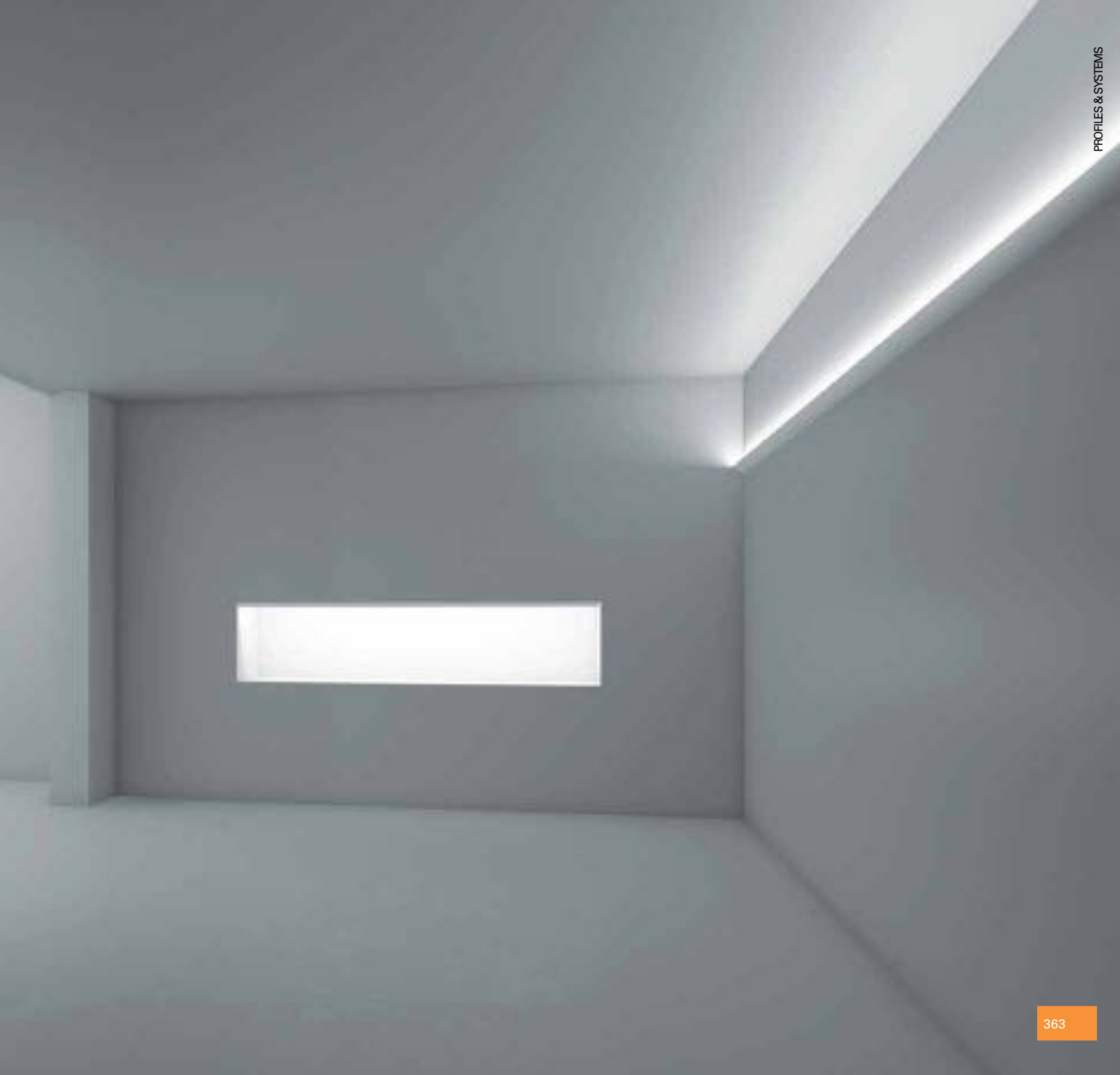

## SEZIONI PROFILO FLIK FLOK

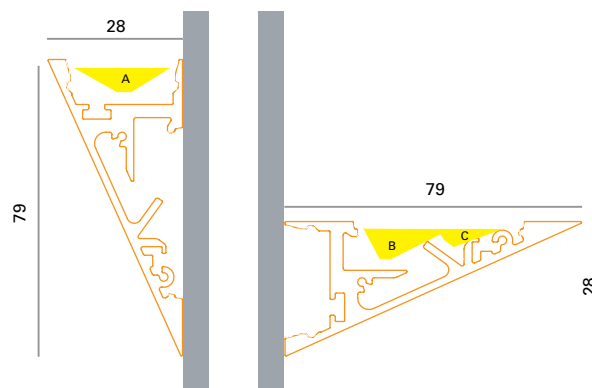

### Un solo profilo diverse possibilità di installazione

Disponibile come profilo vuoto da completare con strip LED (posizionabili nei vani A, B, C o B+C) o completo di moduli led resinati IP65. Da completare con relativi driver da installare remoti.

### One profile, many installation possibilities

Available as empty profile to complete with strip LED (to be fixed into the indicated spaces A, B, C or B+C) or complete with IP65 resined LED modules. To complete with the relative drivers, to be installed remote.

### Un sólo perfil diversas posibilidades de instalación.

Disponibile como perfil vacío a completar con strip LED (pueden colocarse en los vanos A, B, C o B+C) o con módulos led resinados IP65. A completar con los correspondientes alimentadores de instalación remota.

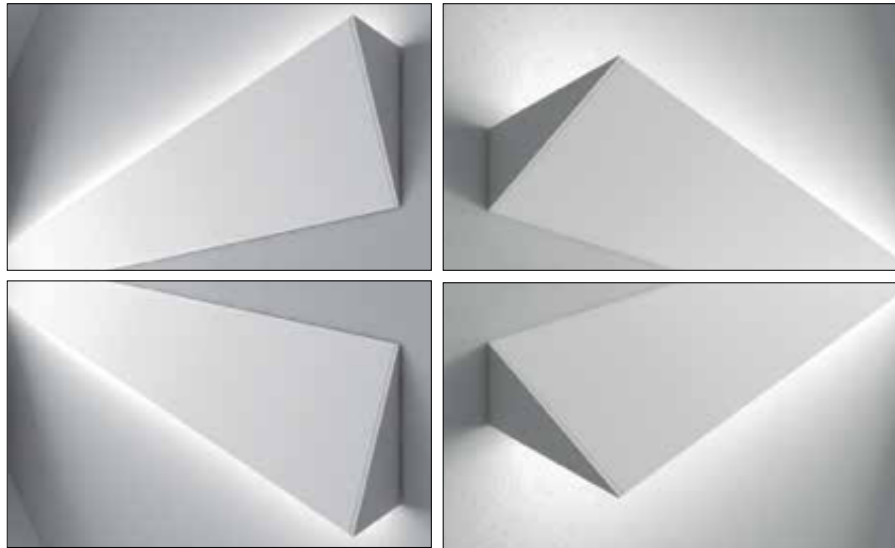

Se fissato per il lato stretto l'illuminazione sarà diffusa se fissato per quello largo l'illuminazione è più radente.









If fixed by the narrow side, the lighting effect is diffused, if fixed instead by the wide side, the lighting is grazing.

Si se fija por el lado estrecho la iluminación es difuminada, si se fija por el lado ancho la iluminación es más directa.







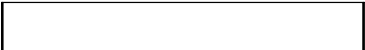



## FLIK - FLOK PARETE INDOOR

WALL - PARED

	W	K	lm product	lm/Led	CRI	A	Lmm	CODE	Col.	
 LINEAR LED A+	6	3000	312	522	>80	V.1	110	FF01	01 60	  
	Da completare con il relativo alimentatore.   To be completed with the relative ballast.   A completar con alimentaci3n.									
 LINEAR LED 24W/MT 2200lm/MT CRI>80 A+	6,4	3000	478	800	>80	7.2	290	FF02	01 60	  
	12,8	3000	736	1232	>80	7.3	570	FF03	01 60	
	19,2	3000	1104	1848	>80	7.3	850	FF04	01 60	
	25,6	3000	1472	2464	>80	7.3	1130	FF05	01 60	
	L <span style="margin-left: 300px;">36</span>									
 <span style="margin-left: 300px;">79</span>										

## FLIK - FLOK PARETE OUTDOOR

WALL - PARED

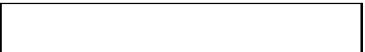
	W	K	lm product	lm/Led	CRI	A	Lmm	CODE	Col.	
 LINEAR LED A+	6	3000	312	522	>80	V.1	110	FF06	01 60	  
	Alimentazione remota non inclusa. Da completare con il relativo alimentatore.   Remote ballast not included. To be completed with the relative ballast.   A completar con alimentaci3n.									
 LINEAR LED 24W/MT 2200lm/MT CRI>80 A+	6,4	3000	478	800	>80	7.2	290	FF07	01 60	  
	L <span style="margin-left: 300px;">36</span>									
 <span style="margin-left: 300px;">79</span>										



---

Sistema modulare a parete o a plafone per illuminazione diretta o indiretta, composto da profili vuoti in estruso di alluminio verniciato, disponibili in lunghezze predefinite di 1000, 2000, 3000 mm o ordinabili a misura completi di diffusori in policarbonato e sistemi di fissaggio. Doppia possibilità di installazione: se fissato per il lato stretto l'illuminazione è diffusa, se fissato per quello largo l'illuminazione è più radente. Da integrare con strip LED e relativi alimentatori elettronici (questi ultimi da installare remoti) e completare con le testate di chiusura laterali con sistema Light Proof. Grado di protezione IP40, IP65.

Wall or ceiling-mounted modular system for direct or indirect lighting, made of painted empty extruded aluminium profiles complete with opal white polycarbonate diffusers, available in predefined lengths or cut to measure. Double installation possibility: if fixed by the narrow side, the lighting effect is diffused, if fixed instead by the wide side, the lighting is grazing. To be completed with LED strips, driver (to be installed remote), Light Proof closure heads and linear and angular joints. Degree of protection IP40, IP65.

Sistema modular de pared o plafón para iluminación directa o indirecta, compuesto por perfiles vacíos en estruso de aluminio barnizado, disponibles en medidas predefinidas de 1000, 2000, 3000mm o que se pueden pedir a medida con difusores en policarbonato y sistema de fijación incluidos. Doble posibilidad de instalación: si se fija por el lado estrecho la iluminación es difuminada, si se fija por el lado ancho la iluminación es más directa. Se debe completar con strip LED y alimentadores electrónicos (estos últimos a instalar remotos) y con las tapas de cierre lateral con sistema "Light Proof". Grado de protección IP40, IP65.

---

## FLIK - FLOK SISTEMA



## PROFILO+DIFFUSORE+STAFFE D'AGGANCIO

PROFILE + DIFFUSER + BRACKETS -PERFIL VACIO + DIFUSORES + SOPORTES DE FIJACION

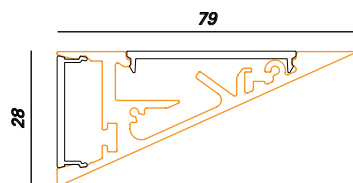

L.mm

1000  
2000  
3000  
.....

CODE

**FFOD.1000**  
**FFOD.2000**  
**FFOD.3000**  
**FFOD.misura**

Col.

**01 60**  
**01 60**  
**01 60**  
**01 60**

## COPPIA TESTATE

COUPLE OF CLOSURE HEADS- PAREJA DE TAPAS FINALES



CODE

**FFTP**

Col.

**01 60**

## COPPIA GIUNTI LINEARI

STRAIGHT CONNECTORS COUPLE - PAREJA DE CONECTORES RECTOS



CODE

**LT2013**

## COPPIA GIUNTI ANGOLARI

ANGLE CONNECTOR COUPLE- CONECTOR ANGULO

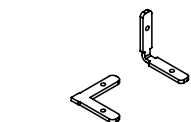

CODE

**FFGA**

01 - bianco - white - blanco 60 - verniciato cor-ten - paintedcor-ten - barnizado cor-ten

## REGLETTE LED RESINATE PER ESTERNI IP65 19W/MT

REGLETTE LED RESINATE PER ESTERNI IP67 19W/MT- RESINED LED BATTEN IP67 19W/MT



LINEAR LED 19W/  
MT IP65 240LED/MT  
1680LM/MT 24V

A+

W	K	Im product	Im/Led	CRI
9,5	3000	840	840	>80
19	3000	1680	1680	>80
28,5	3000	2520	2520	>80
38	3000	3360	3360	>80

V.1  
V.1  
V.1  
V.1

Lmm  
510  
1010  
1510  
2010

CODE  
FF11  
FF12  
FF13  
FF14



## STRIP BOBINA DA 5 METRI

STRIP LED 5 METERS ROLL- BOBINA STRIP LED 5 METROS



LINEAR LED 24V

A+

W/mt	V	Led/mt	Im/mt	K	Im product	Im/W	CRI	IP
5,5	24	60	270	3000	1350	245	80	20
9,6	24	120	540	3000	2700	281	80	20
11	24	180	1200	3000	6000	545	80	20
18	24	168	2200	3000	11000	611	80	20

V.1  
V.1  
V.1  
V.1

Lmm  
5000  
5000  
5000  
5000

Kg  
0,18  
0,18  
0,18  
0,18

CODE  
ST05.30.5  
ST10.30.5  
ST11.30.5  
ST21.30.5

LINEAR LED IP65 24V

A+

W/mt	V	Led/mt	Im/mt	K	Im product	Im/W	CRI	IP
9,6	24	120	540	3000	2700	281	80	65
14,4	24	60	900	3000	4500	313	80	65
19,2	24	240	1080	3000	5400	281	80	65

V.1  
V.1  
V.1

Lmm  
5000  
5000  
5000

Kg  
0,18  
0,18  
0,18

CODE  
ST10.30.5IP  
ST15.30.5IP  
ST20.30.5IP

Sistema componibile per illuminazione diretta e indiretta, diffusa e/o d'accento, composto da moduli in estruso di alluminio verniciato 42x180mm. di lunghezza predefinita, installabile a plafone, parete e sospensione. Moduli completi di sorgenti lineari LED o reglette per lampade fluorescenti T16 e incassi orientabili con sorgente LED professionale o per lampade alogene/LED QR-LP 111. Completi di alimentazione elettronica 50/60Hz 230/240V o 12V/230V. Reglette LED con driver incluso. Disponibile anche modulo cieco in lunghezze predefinite o tagliabile a misura, su cui fissare strip LED per illuminazione indiretta e proiettori orientabili a doppio braccio, completi di sorgenti led professionali o per lampade alogene/LED QR-CB 51, QR-LP 111, QPAR16. Nelle versioni D gli spot non sono dimmerabili, ma solo ON/OFF. Da completare con le testate di chiusura laterali, schermi diffondenti in PC opalino bianco o griglia dark-light in alluminio ad alta specularità e staffe di fissaggio o cavi di sospensione.

Modular system for direct and indirect, diffused and/or accent lighting, consisting of profiles made from 42x180mm mm painted extruded aluminium, with a predefined length, available in the following versions: ceiling-mounted, wall-mounted, suspended. Complete LED linear light source modules or battens for T16 fluorescent lamps and swivel recessed versions with professional LED source or for QR-LP 111 halogen/LED. Complete with 50/60 Hz 230/240V or 12V/230V electronic power supply. Led batten with integrated driver. Blind module also available, in predefined lengths or cut to size, on which to secure LED strips for indirect lighting and swivel double arm projectors, complete with professional LED sources or for QR-CB 51, QR-LP 111, QPAR16 halogen/LED lamps. In D (dimnable) version spots are not dimmable, but only ON/OFF. To be completed with side end caps, opal white PC diffusing screens or dark-light aluminium grille with high specular qualities and mounting brackets or suspension cables.

Sistema componible para iluminación directa, e indirecta, difusa y/o concentrada, compuesto de módulos en estruso aluminio barnizado 42x180 mm de largo predefinido, instalable a plafón, pared y suspensión. Módulos completos de fuentes luminosas lineales LED o regletas para lámparas fluorescentes T16 y empotrados orientables con fuente luminosa LED profesional o para lámparas halógenas/LED QR-LP111. Incluye alimentación electrónica 50/60Hz 230/240V o 12V/230V. Reglette LED con alimentador incluido. Disponible también módulo ciego de longitud predefinida o cortado a medida, donde instalar strip LED para iluminación indirecta y proyectores orientables de doble brazo, completos de fuente de iluminación led profesional o para lámparas halógenas/LED QR-CB 51, QR-LP 111, QPAR16. En la versión D (regulable) los proyectores no son regulables, ma sólo ON/OFF. Se complementan con las tapas de cierre laterales, difusor en PMMA blanco opal o difusor dark-light en aluminio de gran luminosidad, soporte de fijación o cables de suspensión.





**SEGMENT**



EGO ITALIANO MATERA - ITALY  
PROJECT ARCH. GIANFRANCO RONDINONE  
PHOTO A. MOLTERNI









## SEZIONI PROFILO SEGMENT

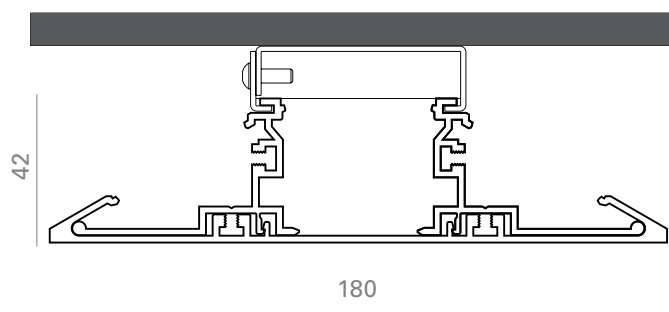

**SOFFITTO - CEILING - TECHO**

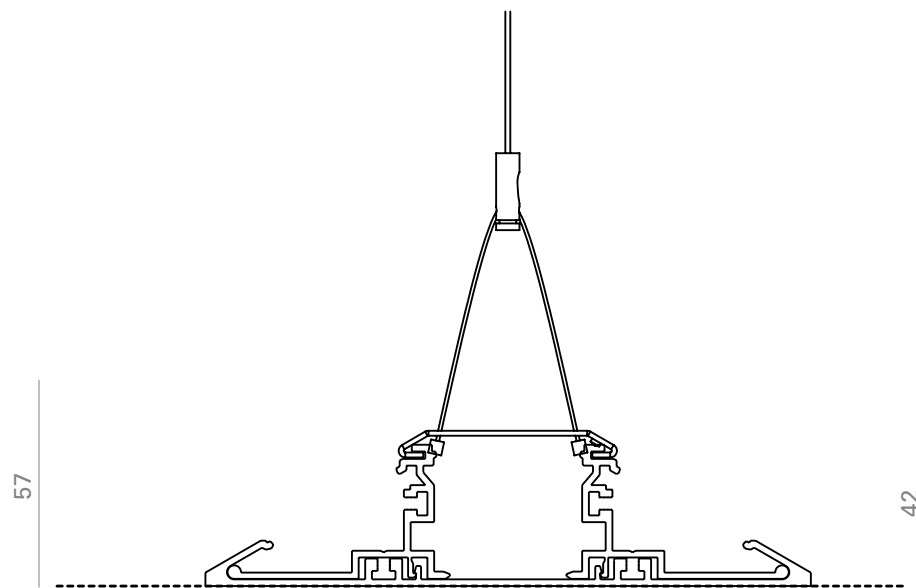



**SOSPENSIONE - SUSPENSION - SUSPENSION**







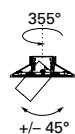
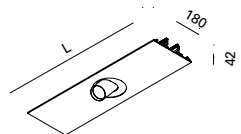

## 1 SPOT LED

	SPOT LED	W	K	lm product	lm/Led	CRI	∠	Lmm	CODE	Col.			
	3SDCM 50000h L90 B10 ta 25°C	1x11	3000	1003	1185	>90	29°					600	LTS41.930F 01 02
		1x11	3000	757	1185	>90	42°					600	LTS41.930W 01 02
		1x11	4000	1088	1285	>90	29°					600	LTS41.940F 01 02
		1x11	4000	821	1285	>90	42°					600	LTS41.940W 01 02
													

## 2 SPOT LED

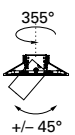
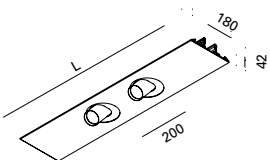
	SPOT LED	W	K	lm product	lm/Led	CRI	∠	Lmm	CODE	Col.			
	3SDCM 50000h L90 B10 ta 25°C	2x11	3000	2006	2370	>90	29°					800	LTS43.930F 01 02
		2x11	3000	1514	2370	>90	42°					800	LTS43.930W 01 02
		2x11	4000	2175	2570	>90	29°					800	LTS43.940F 01 02
		2x11	4000	1642	2570	>90	42°					800	LTS43.940W 01 02
													

### 3 SPOT LED



spot LED  
3SDCM  
50000h L90  
B10 ta 25°C

A+

W	K	Im product	Im/Led	CRI	∠
3x11	3000	3009	3555	>90	29°
3x11	3000	2271	3555	>90	42°
3x11	4000	3263	3855	>90	29°
3x11	4000	2463	3855	>90	42°

Lmm
1000
1000
1000
1000

CODE	Col.
LTS45.930F	01 02
LTS45.930W	01 02
LTS45.940F	01 02
LTS45.940W	01 02

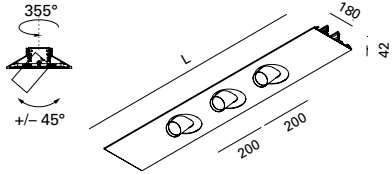

### 4 SPOT LED



spot LED  
3SDCM  
50000h L90  
B10 ta 25°C

A+

W	K	Im product	Im/Led	CRI	∠
4x11	3000	4012	4740	>90	29°
4x11	3000	3028	4740	>90	42°
4x11	4000	4350	5140	>90	29°
4x11	4000	3283	5140	>90	42°

Lmm
1600
1600
1600
1600

CODE	Col.
LTS47930F	01 02
LTS47930W	01 02
LTS47940F	01 02
LTS47940W	01 02



possibile solo nella sospensione H min 30cm | possible for suspended installation H. min. 30cm only . | posible solo para instalacion a suspension H. min. 30cm.

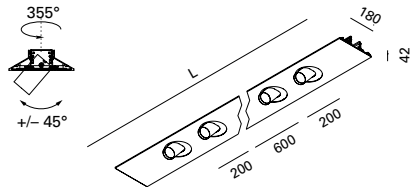

## SPOT + LINEAR LED + SPOT



	W	K	Im product	Im/Led	CRI	Dalit&D	△	Lmm	CODE	Col.
LINEAR LED 24W/MT 2200LM/MT CRI>80	1x19,2	3000	1104	1848	>80			2600	LTSA66	01 02
	2x11	3000	1514	2370	>90		29°			
+ SPOT LED	1x19,2	3000	1104	1848	>80	x		2600	LTSA66D	01 02
	2x11	3000	1514	2370	>90		29°			
	1x19,2	3000	1104	1848	>80			2600	LTSA66	01 02
	2x11	3000	1514	2370	>90		42°			
	1x19,2	3000	1104	1848	>80	x		2600	LTSA66D	01 02
	2x11	3000	1514	2370	>90		42°			
	1x25,6	3000	1472	2464	>80			2900	LTSA67	01 02
	2x11	3000	1514	2370	>90		29°			
	1x25,6	3000	1472	2464	>80	x		2900	LTSA67D	01 02
	2x11	3000	1514	2370	>90		29°			
	1x25,6	3000	1472	2464	>80			2900	LTSA67	01 02
	2x11	3000	1514	2370	>90		42°			
	1x25,6	3000	1472	2464	>80	x		2900	LTSA67D	01 02
	2x11	3000	1514	2370	>90		42°			
	1x32	3000	1840	3080	>80			3200	LTSA68	01 02
	2x11	3000	1514	2370	>90		29°			
	1x32	3000	1840	3080	>80	x		3200	LTSA68D	01 02
	2x11	3000	1514	2370	>90		29°			
	1x32	3000	1840	3080	>80			3200	LTSA68	01 02
	2x11	3000	1514	2370	>90		42°			
	1x32	3000	1840	3080	>80	x		3200	LTSA68D	01 02
	2x11	3000	1514	2370	>90		42°			

50000h Ta 25°  
L70B10 **A+**



	W	K	Im product	Im/Led	CRI	Dalit&D	△	Lmm	CODE	Col.
LINEAR LED 24W/MT 2285LM/MT CRI>80	1x19,2	4000	1147	1920	>80			2600	LTSC66	01 02
	2x11	4000	1514	2370	>90		29°			
+ SPOT LED	1x19,2	4000	1147	1920	>80	x		2600	LTSC66D	01 02
	2x11	4000	1514	2370	>90		29°			
	1x19,2	4000	1147	1920	>80			2600	LTSC66	01 02
	2x11	4000	1514	2370	>90		42°			
	1x19,2	4000	1147	1920	>80	x		2600	LTSC66D	01 02
	2x11	4000	1514	2370	>90		42°			
	1x25,6	4000	1530	2560	>80			2900	LTSC67	01 02
	2x11	4000	1514	2370	>90		29°			
	1x25,6	4000	1530	2560	>80	x		2900	LTSC67D	01 02
	2x11	4000	1514	2370	>90		29°			
	1x25,6	4000	1530	2560	>80			2900	LTSC67	01 02
	2x11	4000	1514	2370	>90		42°			
	1x25,6	4000	1530	2560	>80	x		2900	LTSC67D	01 02
	2x11	4000	1514	2370	>90		42°			
	1x32	4000	1912	3200	>80			3200	LTSC68	01 02
	2x11	4000	1514	2370	>90		29°			
	1x32	4000	1912	3200	>80	x		3200	LTSC68D	01 02
	2x11	4000	1514	2370	>90		29°			
	1x32	4000	1912	3200	>80			3200	LTSC68	01 02
	2x11	4000	1514	2370	>90		42°			
	1x32	4000	1912	3200	>80	x		3200	LTSC68D	01 02
	2x11	4000	1514	2370	>90		42°			

50000h Ta 25°  
L70B10 **A+**



Da completare con diffusore e accessori di installazione. | To be completed with diffuser and installation accessories | Completar con difusor y accesorios de instalación.  
Nelle versioni D gli spot non snp dimmerabili, ma solo ON/OFF. | In D (dimmbale) version spots are not dimmable, but only ON/OFF. | En la verion D (regulable) los proyectores no son regulables, ma solo ON/OFF.

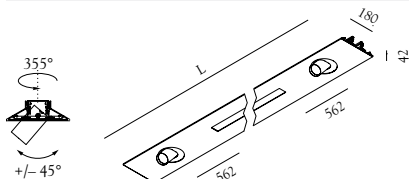

# LINEAR LED + 2 SPOT LED



	W	K	Im product	Im/Led	CRI	DaliT&D	△	Lmm	CODE	Col.	
LINEAR LED 24W/MT 2200lm/MT CRI>80 + SPOT LED	1x25,6	3000	1472	2464	>80		29°	2300	LTSA37	01 02	
	2x11	3000	1514	2370	>90		29°				
	1x25,6	3000	1472	2464	>80	x	29°	2300	LTSA37D	01 02	
	2x11	3000	1514	2370	>90		29°				
	1x25,6	3000	1472	2464	>80		42°	2300	LTSA37D	01 02	
	2x11	3000	1514	2370	>90		42°				
	1x25,6	3000	1472	2464	>80	x	42°	2300	LTSA37D	01 02	
	2x11	3000	1514	2370	>90		42°				
	1x32	3000	1840	3080	>80		29°	2600	LTSA38	01 02	
	2x11	3000	1514	2370	>90		29°				
	1x32	3000	1840	3080	>80	x	29°	2600	LTSA38D	01 02	
	2x11	3000	1514	2370	>90		29°				
	1x32	3000	1840	3080	>80		42°	2600	LTSA38	01 02	
	2x11	3000	1514	2370	>90		42°				
	1x32	3000	1840	3080	>80	x	42°	2600	LTSA38D	01 02	
	2x11	3000	1514	2370	>90		42°				
	50000h Ta 25° L70B10	2x11	3000	1514	2370	>90		42°			

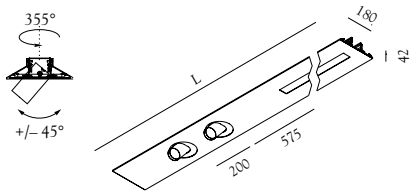

	W	K	Im product	Im/Led	CRI	DaliT&D	△	Lmm	CODE	Col.	
LINEAR LED 24W/MT 2285lm/MT CRI>80 + SPOT LED	1x25,6	4000	1530	2560	>80		29°	2300	LTSC37	01 02	
	2x11	4000	1514	2370	>90		29°				
	1x25,6	4000	1530	2560	>80	x	29°	2300	LTSC37D	01 02	
	2x11	4000	1514	2370	>90		29°				
	1x25,6	4000	1530	2560	>80		42°	2300	LTSC37D	01 02	
	2x11	4000	1514	2370	>90		42°				
	1x25,6	4000	1530	2560	>80	x	42°	2300	LTSC37D	01 02	
	2x11	4000	1514	2370	>90		42°				
	1x32	4000	1912	3200	>80		29°	2600	LTSC38	01 02	
	2x11	4000	1514	2370	>90		29°				
	1x32	4000	1912	3200	>80	x	29°	2600	LTSC38D	01 02	
	2x11	4000	1514	2370	>90		29°				
	1x32	4000	1912	3200	>80		42°	2600	LTSC38	01 02	
	2x11	4000	1514	2370	>90		42°				
	1x32	4000	1912	3200	>80	x	42°	2600	LTSC38D	01 02	
	2x11	4000	1514	2370	>90		42°				
	50000h Ta 25° L70B10	2x11	4000	1514	2370	>90		42°			

Da completare con diffusore e accessori di installazione | To be completed with diffuser and installation accessories | Completar con difusor y accesorios de instalación.  
 Nelle versioni D gli spot non snp dimmerabili, ma solo ON/OFF. | In D (dimmmable) version spots are not dimmmable, but only ON/OFF. | En la verion D (regulable) los proyectores no son regulables, ma soló ON/OFF.



## LINEAR LED

ELEMENT LED- MODULO LED

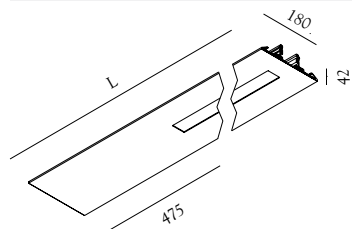

	W	K	lm product	lm/Led	CRI	DalIT&D	Lmm	CODE	Col.	
 <p>LINEAR LED 24W/MT 2200lm/MT CRI&gt;80</p> <p>50000h Ta 25° L70B10 <b>A+</b></p>	19,2	3000	1104	1848	>80		1400	<b>LTSA31</b>	<b>01 02</b>	
	19,2	3000	1104	1848	>80	x	1400	<b>LTSA31D</b>	<b>01 02</b>	
	25,6	3000	1472	2464	>80		1700	<b>LTSA32</b>	<b>01 02</b>	
	25,6	3000	1472	2464	>80	x	1700	<b>LTSA32D</b>	<b>01 02</b>	
	32	3000	1840	3080	>80		2000	<b>LTSA33</b>	<b>01 02</b>	
	32	3000	1840	3080	>80	x	2000	<b>LTSA33D</b>	<b>01 02</b>	
<p>LINEAR LED 24W/MT 2285lm/MT CRI&gt;80</p> <p>50000h Ta 25° L70B10 <b>A+</b></p>	19,2	4000	1147	1920	>80		1400	<b>LTSC31</b>	<b>01 02</b>	
	19,2	4000	1147	1920	>80	x	1400	<b>LTSC31D</b>	<b>01 02</b>	
	25,6	4000	1530	2560	>80		1700	<b>LTSC32</b>	<b>01 02</b>	
	25,6	4000	1530	2560	>80	x	1700	<b>LTSC32D</b>	<b>01 02</b>	
	32	4000	1912	3200	>80		2000	<b>LTSC33</b>	<b>01 02</b>	
	32	4000	1912	3200	>80	x	2000	<b>LTSC33D</b>	<b>01 02</b>	

Da completare con diffusore e accessori di installazione | To be completed with diffuser and installation accessories | Completar con difusor y accesorios de instalación.



## LINEAR LED SIMMETRICO

LINEAR LED MODULE- LINEAL LED MODULO

	W	K	lm product	lm/Led	CRI	DalIT&D	Lmm	CODE	Col.	
 <p>LINEAR LED 24W/MT 2200lm/MT CRI&gt;80</p> <p>50000h Ta 25° L70B10 <b>A+</b></p>	19,2	3000	1104	1848	>80		1400	<b>LTSB13</b>	<b>01 02</b>	
	19,2	3000	1104	1848	>80	x	1400	<b>LTSB13D</b>	<b>01 02</b>	
	25,6	3000	1472	2464	>80		1700	<b>LTSB14</b>	<b>01 02</b>	
	25,6	3000	1472	2464	>80	x	1700	<b>LTSB14D</b>	<b>01 02</b>	
	32	3000	1840	3080	>80		2000	<b>LTSB15</b>	<b>01 02</b>	
	32	3000	1840	3080	>80	x	2000	<b>LTSB15D</b>	<b>01 02</b>	
<p>LINEAR LED 24W/MT 2285lm/MT CRI&gt;80</p> <p>50000h Ta 25° L70B10 <b>A+</b></p>	19,2	4000	1147	1920	>80		1400	<b>LTSF13</b>	<b>01 02</b>	
	19,2	4000	1147	1920	>80	x	1400	<b>LTSF13D</b>	<b>01 02</b>	
	25,6	4000	1530	2560	>80		1700	<b>LTSF14</b>	<b>01 02</b>	
	25,6	4000	1530	2560	>80	x	1700	<b>LTSF14D</b>	<b>01 02</b>	
	32	4000	1912	3200	>80		2000	<b>LTSF15</b>	<b>01 02</b>	
	32	4000	1912	3200	>80	x	2000	<b>LTSF15D</b>	<b>01 02</b>	

Da completare con diffusore e accessori di installazione | To be completed with diffuser and installation accessories. | Completar con difusor y accesorios de instalación.

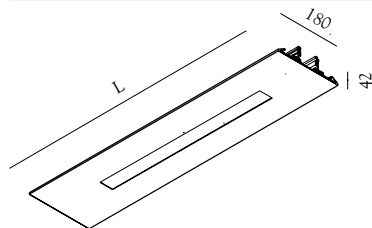

## 2 LINEAR LED

### ELEMENT 2 LED- MODULO 2 LED



	W	K	lm product	lm/Led	CRI	DaliT&D	Lmm	CODE	Col.	
LINEAR LED 24W/MT 2200LM/MT CRI>80	2x19,2	3000	2208	3696	>80		2350	LTSA34	01 02	
	2x19,2	3000	2208	3696	>80	x	2350	LTSA34D	01 02	
	2x25,6	3000	2944	4928	>80		2950	LTSA35	01 02	
	2x25,6	3000	2944	4928	>80	x	2950	LTSA35D	01 02	
	2x32	3000	3681	6160	>80		3550	LTSA36	01 02	
	2x32	3000	3681	6160	>80	x	3550	LTSA36D	01 02	
50000h Ta 25° L70B10										
LINEAR LED 24W/MT 2285LM/MT CRI>80	2x19,2	4000	2294	3840	>80		2350	LTSC34	01 02	
	2x19,2	4000	2294	3840	>80	x	2350	LTSC34D	01 02	
	2x25,6	4000	3059	5120	>80		2950	LTSC35	01 02	
	2x25,6	4000	3059	5120	>80	x	2950	LTSC35D	01 02	
	2x32	4000	3824	6400	>80		3550	LTSC36	01 02	
	2x32	4000	3824	6400	>80	x	3550	LTSC36D	01 02	
50000h Ta 25° L70B10										

Da completare con diffusori e accessori di alimentazione e installazione. | To be completed with diffusers and feed and installation accessories. | Completar con difusors y alimentaci3n y accesorios de instalaci3n.

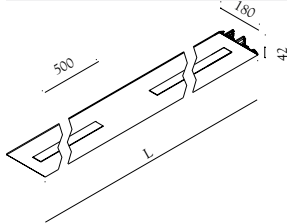

## LED MODULO SOFFITTO PER INSTALLAZIONE ANGOLO PARETE-SOFFITTO.



LINEAR LED CEILING -MOUNTED MODULE FOR WALL-CEILING ANGLE INSTALLATION - LED MODULS DE TECHO PARA LA INSTALACI3N 1NGULO DE PARED-TECHO



	W	K	lm product	lm/Led	CRI	Lmm	CODE	Col.	
LINEAR LED 24W/MT 2200LM/MT CRI>80	19,2	3000	1104	1848	>80	1330	LTSA90A1	01 02	
	25,6	3000	1472	2464	>80	1630	LTSA90B1	01 02	
50000h Ta 25° L70B10									
LINEAR LED 24W/MT 2285LM/MT CRI>80	19,2	4000	1147	1920	>80	1330	LTSC90A2	01 02	
	25,6	4000	1530	2560	>80	1630	LTSC90B2	01 02	
50000h Ta 25° L70B10									
LINEAR LED 41W/MT 4640LM/MT CRI90	34,2	3000	1910	3900	90	1330	LTSA90A3	01 02	
	45,6	3000	2547	5200	90	1630	LTSA90B3	01 02	
A+									
LINEAR LED 41W/MT 4820LM/MT CRI90	34,2	4000	1984	4050	90	1330	LTSC90A4	01 02	
	45,6	4000	2645	5400	90	1630	LTSC90B4	01 02	
A+									



01 - bianco - white - blanco 02 - nero - black - negro

## 1 SPOT

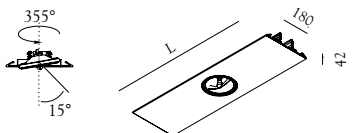
	QR-LP 111 G53 12V	W 1x Led/Halo max 60	Lmm 600	CODE LTS041	Col. 01 02	
	*possibile solo nella sospensione H min 30cm   *possible only suspension H min 30cm   *posible solo para la supension H min 30cm					



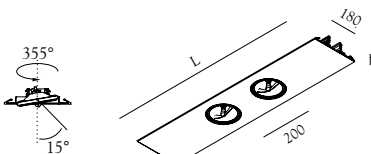

## 2 SPOT

	QR-LP 111 G53 12V	W 2x Led/Halo max 60	Lmm 800	CODE LTS043	Col. 01 02	
	*possibile solo nella sospensione H min 30cm   *possible only suspension H min 30cm   *posible solo para la supension H min 30cm					



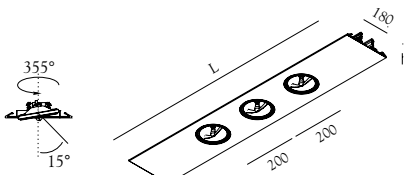

## 3 SPOT

	QR-LP 111 G53 12V	W 3x Led/Halo max 60	Lmm 1000	CODE LTS045	Col. 01 02	
	*possibile solo nella sospensione H min 30cm   *possible only suspension H min 30cm   *posible solo para la supension H min 30cm					



## 4 SPOT

	QR-LP 111 G53 12V	W 4x Led/Halo max 60	Lmm 1600	CODE LTS047	Col. 01 02	
	*possibile solo nella sospensione H min 30cm   *possible only suspension H min 30cm   *posible solo para la supension H min 30cm					

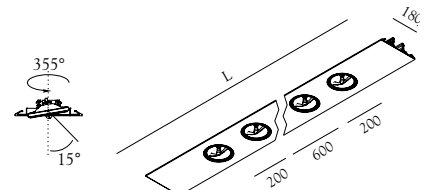



## LINEAR FLUO+SPOT

SPOT+FLUO+SPOT- SPOT+FLUO+SPOT



	W	DaliT&D	Lmm	CODE	Col.	
T16 G5 230V QR-LP 111	1x21-39		2600	LTS066	01 02	
	2 x Led/Halo max 60					
	1x21-39	x	2600	LTS066D	01 02	
	2 x Led/Halo max 60					
	1x28-54		2900	LTS067	01 02	
	2 x Led/Halo max 60					
	1x28-54	x	2900	LTS067D	01 02	
	2 x Led/Halo max 60					
	1x35-49-80		3200	LTS068	01 02	
	2 x Led/Halo max 60					
	1x35-49-80	x	3200	LTS068D	01 02	
	2 x Led/Halo max 60					

\*possibile solo nella sospensione H min 30cm. Da completare con diffusore e accessori di installazione | \*possible only suspension H min 30cm. To be completed with diffusers and installation accessories. | \*posible solo para la suspension H min 30cm. Completar con difusores y accesorios de instalación. Nelle versioni D gli spot non snp dimmerabili, ma solo ON/OFF. | In D (dimnable) version spots are not dimmable, but only ON/OFF. | En la verion D (regulable) los proyectores no son regulables, ma soló ON/OFF.

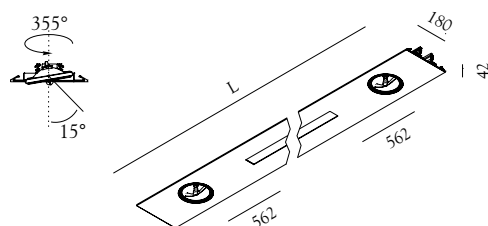

## 2 LINEAR FLUO

2 LINEAR FLUO MODULE - ELEMENTO 2 FLUO



	W	DaliT&D	Lmm	CODE	Col.	
T16 G5 230V	1+1x21-39		2350	LTS034	01 02	
	1+1x21-39	x	2350	LTS034D	01 02	
	1+1x28-54		2950	LTS035	01 02	
	1+1x28-54	x	2950	LTS035D	01 02	
	1+1x35-49		3550	LTSB36	01 02	
	1+1x35-49	x	3550	LTSB36D	01 02	
	1+1x80		3550	LTSB37	01 02	
	1+1x80	x	3550	LTSB37D	01 02	

Da completare con diffusori e accessori di installazione | To be completed with diffusers and installation accessories | Completar con difusores y accesorios de instalación.

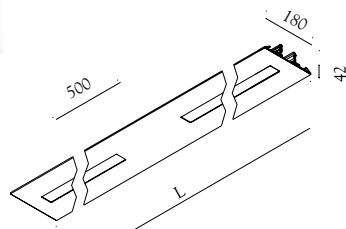

## LINEAR FLUO+2 SPOT



	W	DaliT&D	Lmm	CODE	Col.	
T16 G5 230V + QR-LP 111	1x28-54 2 x Led/Halo max 60	x	2300	LTS037	01 02	
	1x28-54 2 x Led/Halo max 60		2300	LTS037D	01 02	
	1x35-49-80 2 x Led/Halo max 60	x	2600	LTS038	01 02	
	1x35-49-80 2 x Led/Halo max 60		2600	LTS038D	01 02	

\*possibile solo nella sospensione H min 30cm. Da completare con diffusore e accessori di alimentazione e installazione. | \*possible only suspension H min 30cm. To be completed with diffuser and feed and installation accessories. | \*posible solo para la suspension H min 30cm. Completar con difusor y alimentación y accesorios de instalación.  
 Nelle versioni D gli spot non snp dimmerabili, ma solo ON/OFF. | In D (dimmmable) version spots are not dimmable, but only ON/OFF. | En la verion D (regulable) los proyectores no son regulables, ma soló ON/OFF .

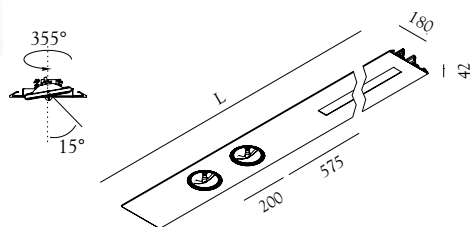

## LINEAR FLUO



	W	DaliT&D	Lmm	CODE	Col.	
T16 G5 230V	1x21-39 1x21-39	x	1400	LTS031	01 02	
	1x28-54 1x28-54		1400	LTS031D	01 02	
	1x35-49-80 1x35-49-80	x	1700	LTS032	01 02	
	1x35-49-80 1x35-49-80		1700	LTS032D	01 02	
			2000	LTS033	01 02	
			2000	LTS033D	01 02	

Da completare con diffusore e accessori di installazione. | To be completed with diffuser and installation accessories | Completar con difusor y accesorios de instalación.

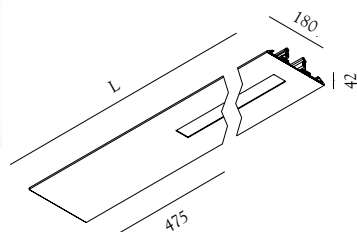

## PROFILO PIENO

EMPTY PROFILE- PERFIL VACIO

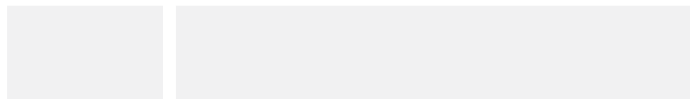

Lmm	CODE	Col.
1000	LTS000.1000	01 02
2000	LTS000.2000	01 02
3000	LTS000.3000	01 02
.....	LTS000.misura*	01 02

\*Tramite questo codice è possibile ordinare il profilo in una lunghezza lineare non standard. Sostituire alla parola "misura" la lunghezza desiderata in mm. Per ordinare un profilo con una o entrambe le estremità tagliate ad angolo 45° aggiungere alla misura la lettera "D" (taglio Destro) o "S" (taglio Sinistro). Seguire istruzioni riportate a pag. 834. Per profili oltre i 3 mt e massimo 6 mt le condizioni di trasporto sono da concordare. |

\*Through this code it's possible to order the profile in a not-standard linear length. Replace the word "misura" with the desired length in mm. To order a profile with one or both ends 45° angle-cut add the letter "D" (right cut) or "S" (left cut) to the standard or custom length. Follow the instructions on page 834. For lengths over 3 mt. to max. 6 mt. transport conditions to negotiate. |

\*El uso de este código, se puede ordenar el perfil en un lineal longitud no estándar. Sustitúyase la palabra "medida" de la longitud en mm. Para pedir un perfil con uno o ambos extremos cortados en un ángulo de 45° a añadir a la medida de la letra "D" (derecha cortada) o "S" (izquierda cortada). Siga las instrucciones de la página. 834. Perfiles para más de 3 my 6 m Condiciones máximas de transporte a convenir.

## ANGOLO 90°

90° ANGLE- ANGULO 90°



Lmm	CODE	Col.
180X180	LTS090	01 02

## COPPIA TESTATE DI CHIUSURA

COUPLE OF CLOSURE HEADS - PAREJA DE TAPAS FINALES

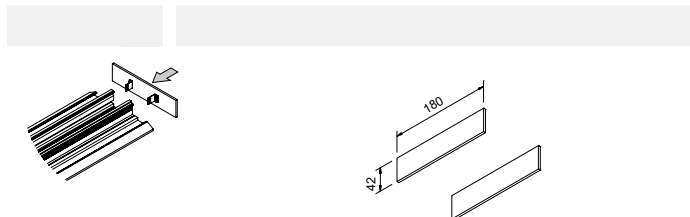

CODE	Col.
LTS050	01 02

01 - bianco - white - blanco 02 - nero - black - negro

## DIFFUSORE FRONTALE IN POLICARBONATO BIANCO OPALINO

FRONT OPAL WHITE POLYCARBONATE DIFFUSER- DIFUSOR FRENTE EN POLICARBONATO BLANCO OPALINO

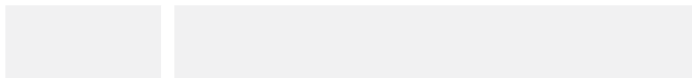

Lmm	CODE
874	LTS234
1174	LTS235
1474	LTS236

L'utilizzo del diffusore conferisce al prodotto un grado di protezione IP40 | The use of the diffuser give to the product a protection degree IP40 | La utilizacion del difusor confiere al producto un nivel de proteccion IP40

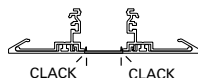

## DIFFUSORE INDIRETTO LATERALE E SUPERIORE LINEARE

OPAL WHITE SIDE AND UPPER LINEAR DIFFUSER - DIFUSOR LATERAL Y SUPERIOR LINEAL OPALINO



Lmm	CODE
.....	LTS051.misura*

Il codice e il prezzo si intendono cadauno. L'utilizzo del diffusore conferisce al prodotto un grado di protezione IP40.

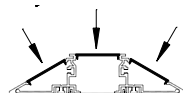

## DIFFUSORE INDIRETTO LATERALE PER INSTALLAZIONE PROFILO FILO MURO

INDIRECT OPAL WHITE SIDE DIFFUSER FOR WALL INSTALLATION- DIFUSOR INDIRECTO OPALINO BLANCO PARA INSTALACION CONTRA LA PARED

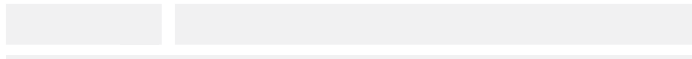

Lmm	CODE
.....	LTS051f.misura*

Il codice e il prezzo si intendono cadauno. Solo per installazione a plafone. L'utilizzo del diffusore conferisce al prodotto un grado di protezione IP40.

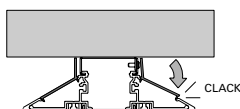

\*Tramite questo codice è possibile ordinare il profilo in una lunghezza lineare non standard. Sostituire alla parola "misura" la lunghezza desiderata in mm. Per ordinare un profilo con una o entrambe le estremità tagliate ad angolo 45° aggiungere alla misura la lettera "D" (taglio Destro) o "S" (taglio Sinistro). Seguire istruzioni riportate a pag. 834. Per profili oltre i 3 mt e massimo 6 mt le condizioni di trasporto sono da concordare. |

\*Through this code it's possible to order the profile in a not-standard linear length. Replace the word "misura" with the desired length in mm. To order a profile with one or both ends 45° angle-cut add the letter "D" (right cut) or "S" (left cut) to the standard or custom length. Follow the instructions on page 834. For lengths over 3 mt. to max. 6 mt. transport conditions to negotiate. |

\*El uso de este código, se puede ordenar el perfil en un lineal longitud no estándar. Sustitúyase la palabra "medida" de la longitud en mm. Para pedir un perfil con uno o ambos extremos cortados en un ángulo de 45° a añadir a la medida de la letra "D" (derecha cortada) o "S" (izquierda cortada). Siga las instrucciones de la página. 834. Perfiles para más de 3 my 6 m Condiciones máximas de transporte a convenir.

## DIFFUSORE LATERALE E SUPERIORE PER ANGOLO 90° PER SOSPENSIONE

OPAL WHITE SIDE AND UPPER DIFFUSER FOR 90° ANGLE - DIFFUSOR LATERAL Y SUPERIOR OPALINO POR ANGULO 90°



per sospensione / for hanging-mounting / por suspension

CODE  
LTS051.90P

Il codice e il prezzo si intendono cadauno. L'utilizzo del diffusore conferisce al prodotto un grado di protezione IP40.

## DIFFUSORE INDIRETTO LATERALE PER ANGOLO 90° PER PLAFONE

OPAL WHITE INDIRECT DIFFUSER FOR 90° ANGLE WHEN WALL-MOUNTED WITH INDIRECT AGAINST WALL- DIFUSOR INDIRECTO OPALINO BLANCO POR ANGULO 90° CONTRA LA PARED



per plafone / for ceiling-mounting / por techo

CODE  
LTS051F.90

Il codice e il prezzo si intendono cadauno. Solo per installazione a plafone. L'utilizzo del diffusore conferisce al prodotto un grado di protezione IP40.

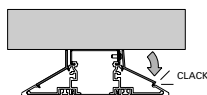

## DIFFUSORE PARETE/SOFFITTO

WALL/CEILING OPAL WHITE POLYCARBONATE DIFFUSER- DIFUSOR PARED/TECHO EN POLICARBONATO BLANCO OPALINO



Dim.  
250x250

CODE  
LTS051F250PS

## KIT GIUNTI PARETE/SOFFITTO COPPIA

WALL/CEILING JOINT KIT COUPLE- KIT DE UNION PARED/TECHO PAREJA

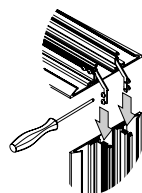

CODE  
LTS052.90PS

## KIT GIUNTI LINEARI COPPIA

LINEAR JOINT KIT COUPLE- KIT DE UNION LINEAL PAREJA



Uno ogni 1,5mt, minimo 2 - one every 1,5mt, 2 pieces minimum - uno cada 1,5mt, minimo 2 piezas

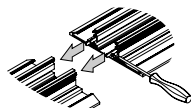

CODE  
LTS052

## KITSINGOLO IN ACCIAIO PER MONTAGGIO A PLAFONE

SINGLE STEEL KIT FOR CEILING-MOUNTING - ANCLAJE EN ACERO PARA TECHO



Uno ogni 2 mt, minimo 2 - one every 2 mt, 2 pieces minimum - uno cada 2 mt, minimo 2 piezas

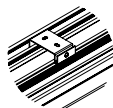

CODE Col.  
LTS049 01 02

## KIT SOSPENSIONE

SINGLE STEEL SUSPENSION KIT- KIT SUSPENSION

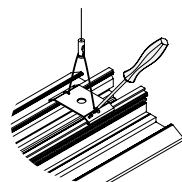

Lmm  
2000  
4000

CODE Col.  
LTS055 01 02  
LTS055.4000 01 02

## CAVO D'ALIMENTAZIONE COMPLETO DI ROSONE

WIRING FEED CABLE COMPLETE WITH CANOPY- CABLE DE ALIMENTACION Y FLORON



Dim.	Lmm	CODE	Col.
3X0,75	2000	LTS053.3	01 02
4X0,75	2000	LTS053.4	01 02
5X0,75	4000	LTS053.4000.5	01 02
7X0,75	4000	LTS053.4000.7	01 02
4X0,75	4000	LTS053.4000.4	01 02
9X0,75	4000	LTS053.4000.9	01 02
3X0,75	4000	LTS053.4000.3	01 02
5X0,75	2000	LTS053.5	01 02
7X0,75	2000	LTS053.7	01 02
9X0,75	2000	LTS053.9	01 02

01 - bianco - white - blanco 02 - nero - black - negro

## PIASTRA DI CHIUSURA SUPERIORE PER MODULI FLUO

UPPER METAL COVER FOR FLUO MODULES - PLACA OPCIONAL POR MODULOS FLUO

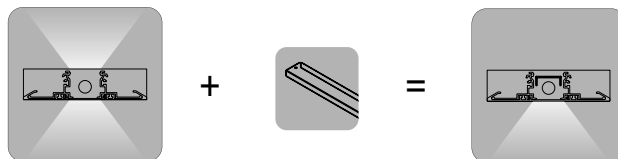

Lmm

872  
1172  
1472

CODE

LTS054.21  
LTS054.28  
LTS054.35

## REGLETTE FLUO INDIRECTA

INDIRECT FLUO BATTEN- REGLETTE FLUO INDIRECTA

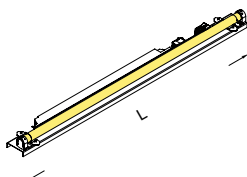

T16 G5 230V

A<sup>+</sup>A

W

21-39  
21-39  
28-54  
28-54  
35-49-80  
35-49-80

Lmm

875  
875  
1175  
1175  
1475  
1475

CODE

L TSA69  
L TSA69D  
L TSA70  
L TSA70D  
L TSA71  
L TSA71D

IP20



## SEGMENT SISTEMA STRIP BOBINA DA 5 METRI

STRIP BOBINA DA 5 METRI- STRIP LED 5 METERS ROLL- BOBINA STRIP LED 5 METROS



LINEAR LED 24V

A<sup>+</sup>

W/mt	V	Led/ mt	lm/mt	K	lm product	lm/W	CRI	IP
5,5	24	60	270	3000	1350	245	80	20
9,6	24	120	540	3000	2700	281	80	20
11	24	180	1200	3000	6000	545	80	20
18	24	168	2200	3000	11000	611	80	20

A

V.2

V.2

V.2

V.2

Lmm

5000

5000

5000

5000

Kg

0,18

0,18

0,18

0,18

CODE

ST05.30.5

ST10.30.5

ST11.30.5

ST21.30.5



LINEAR LED IP65 24V

A<sup>+</sup>

W/mt	V	Led/ mt	lm/mt	K	lm product	lm/W	CRI	IP
9,6	24	120	540	3000	2700	281	80	65
14,4	24	60	900	3000	4500	313	80	65
19,2	24	240	1080	3000	5400	281	80	65

A

V.2

V.2

V.2

Lmm

5000

5000

5000

Kg

0,18

0,18

0,18

CODE

ST10.30.5IP

ST15.30.5IP

ST20.30.5IP





## SPOT 55 LED



LED	W	mA	K	lm product	lm/Led	CRI	∠	A	Dim.	CODE	Col.
3SDCM 50000h L90 B10 ta 25°C	11	350	2700	931	1100	>90	29°	3.3	ø55	SG001.927S	01 02
	11	350	2700	703	1100	>90	42°	3.3	ø55	SG001.927F	01 02
	11	350	3000	1003	1185	>90	29°	3.3	ø55	SG001.930S	01 02
	11	350	3000	757	1185	>90	42°	3.3	ø55	SG001.930F	01 02
	11	350	4000	1088	1285	>90	29°	3.3	ø55	SG001.940S	01 02
	11	350	4000	821	1285	>90	42°	3.3	ø55	SG001.940F	01 02

\* installabile solo su moduli con fluorescenza o led lineari e su profilo vuoto LTS000.misura/xx | \* use only on modules for fluo or linear leds (only) and on empty profiles LTS000. misura/xx | \* instalar sólo en unidades con fluorescente o lineal led y en perfil vacío LTS000.misura/xx



## SPOT 90 LED



LED	W	mA	K	lm product	lm/Led	CRI	∠	A	Dim.	CODE	Col.
3SDCM 50000h L90 B10 ta 25°C	17	500	2700	1438	1790	95	15°	5.3	ø90	SG021.927S	01 02
	24,3	700	2700	1904	2370	95	24°	7.4	ø90	SG021.927F	01 02
	17	500	2700	1530	1790	95		5.3			
	24,3	700	2700	2011	2370	95	38°	7.4	ø90	SG021.927W01 02	
	17	500	2700	1609	1790	95		5.3			
	24,3	700	2700	2095	2370	95	15°	7.4	ø90	SG021.930S	01 02
	17	500	3000	1546	1925	95		5.3			
	24,3	700	3000	2045	2545	95	24°	7.4	ø90	SG021.930F	01 02
	17	500	3000	1645	1925	95		5.3			
	24,3	700	3000	2160	2545	95	38°	7.4	ø90	SG021.930W01 02	
	17	500	3000	1730	1925	95		5.3			
	24,3	700	3000	2250	2545	95	15°	7.4	ø90	SG021.940S	01 02
	17	500	4000	1699	2115	95		5.3			
	24,3	700	4000	2250	2800	95	24°	7.4	ø90	SG021.940F	01 02
	17	500	4000	1807	2115	95		5.3			
	24,3	700	4000	2376	2800	95	38°	7.4	ø90	SG021.940W01 02	
	17	500	4000	1901	2115	95		5.3			
	24,3	700	4000	2475	2800	95		7.4	ø90		

\* installabile solo su moduli con fluorescenza o led lineari e su profilo vuoto LTS000.misura/xx | \* use only on modules for fluo or linear leds (only) and on empty profiles LTS000. misura/xx | \* instalar sólo en unidades con fluorescente o lineal led y en perfil vacío LTS000.misura/xx



accessori - accessories  
accesorios pag. 396

## SPOT QR-CB 51 12V

	QR-CB51 GU5,3 12V	W	A	Dim.	CODE	Col.	
	1 x Led/Hal max 50		<b>T.1</b>	ø55	<b>SG011</b>	<b>01 02</b>	

\* installabile solo su moduli con fluorescenza o led lineari e su profilo vuoto LTS000.misura/xx | \* use only on modules for fluo or linear leds (only) and on empty profiles LTS000.misura/xx | \* instalar sólo en unidades con fluorescente o lineal led y en perfil vacío LTS000.misura/xx

## SPOT QPAR16 GU10

	QPAR16 GU10 230V	W	Dim.	CODE	Col.	
	1 x Led/Hal max 50		ø55	<b>SG012</b>	<b>01 02</b>	

\* installabile solo su moduli con fluorescenza o led lineari e su profilo vuoto LTS000.misura/xx | \* use only on modules for fluo or linear leds (only) and on empty profiles LTS000.misura/xx | \* instalar sólo en unidades con fluorescente o lineal led y en perfil vacío LTS000.misura/xx

## SPOT QR-LP111

	QR-LP 111 G53 12V	W	A	CODE	Col.	
	1 x Led/Hal max 60		<b>T.2</b>	<b>SG031</b>	<b>01 02</b>	

Att.ne lampadina QR111 led non superare peso di 275gr. installabile solo su moduli con fluorescenza o led lineari e su profilo vuoto LTS000.misura/xx | The maximum allowed weight of 12V QR-LP 111 LED lamps is of 275 gr. Use only on modules for fluo or linear leds (only) and on empty profiles LTS000.misura/xx | El peso máximo admisible de las lámparas LED QR-LP 111 para nuestros proyectores es de 275gr. Instalar sólo en unidades con fluorescente o lineal led y en perfil vacío LTS000.misura/xx.

01 - bianco - white - blanco 02 - nero - black - negro

## RIFLETTORE PER SPOT 90 LED

REFLECTOR Ø85 FOR SPOT 90 LED- REFLECTORE Ø85



Optic	Dim.	Kg	CODE	Col.
15°	Ø 85	0,05	R085S.A	01 02
24°	Ø 85	0,05	R085FA	01 02
38°	Ø 85	0,05	R085W.A	01 02



lenti - lentes - lentes

## ANELLO CON LENTE

LENS WITH RING - ANILLO CON LENTE



ANELLO CON LENTE SATINATA / SATIN LENS WITH RING / ANILLO CON LENTE SATINADA

Dim.	Kg	CODE	Col.
Ø 85	0,02	L085S.A	01 02



ANELLO CON LENTE FRESNEL / FRESNEL LENS WITH RING / ANILLO CON LENTE FRESNEL

Dim.	Kg	CODE	Col.
Ø 85	0,02	L085FA	01 02



ANELLO CON LENTE ELISSOIDALE / ELIPSOID LENS/ CON LENTE ELIPSOIDAL

Dim.	Kg	CODE	Col.
Ø 85	0,02	L085EA	01 02



ANELLO CON LENTE ASIMMETRICA / ASYMMETRIC LENS/ CON LENTE ASIMÉTRICA

Dim.	Kg	CODE	Col.
Ø 85	0,02	L085AA	01 02



FILTRO NIDO D'APE / RING WITH HONEY COMB LOUVER/ REJILLA DE NIDO DE ABEJA

Dim.	Kg	CODE	Col.
Ø 85	0,02	L085RA	01 02





STUDIO ODONTOIATRICO G.CALESINI ROMA - ITALY  
PROJECT I.CAPRA, G.GRAZIANI, C.SARAPO ARCHITETTI  
PHOTO F.GALLI

Sistema modulare da incasso a scomparsa totale trimless con cui realizzare tagli di larghezza 138 o 68 mm. in controsoffitto e controparete di cartongesso rettilinei, ad "L", quadrati e rettangolari, per illuminazione diretta e indiretta, diffusa e d'accento. Composto da coppie di guide in estruso di alluminio lineari, ad angolo 90° e di testata, di lunghezza predefinita e assemblabili nella lunghezza desiderata, da fissare, stuccare e rasare nel cartongesso, cui agganciare nei punti desiderati: sorgenti lineari LED o reglette per lampade fluorescenti T16 e proiettori orientabili a doppio braccio, completi di sorgenti led professionali o per lampade alogene/LED QR-CB 51, QR-LP 111, QPAR16. Reglette fluorescenti complete di alimentazione elettronica 50/60Hz 230/240V. Reglette LED con driver incluso. Completabile con canale di copertura in metallo verniciato fornito in lastre stese preforate per una rapida sagomatura a mano in cantiere (volume occupato ridotto di 110 volte rispetto a canali analoghi già sagomati). Da completare con testate di chiusura, schermi diffondenti in PC opalino bianco per sorgenti LED lineari e reglette fluorescenti e giunti di fissaggio.

Trimless fully-retractable flush recessed modular system with which to make cuts with a width of 138 or 68 mm in rectilinear, "L-shaped", square and rectangular plasterboard false ceilings and double walls, for direct and indirect, diffused and accent lighting. Consisting of pairs of linear extruded aluminium guides, with a 90° angle and head, with a predefined length and which can be assembled to the desired length, to secure, stucco and smooth in the plasterboard, which can be attached where required: LED linear light sources or battens for T16 fluorescent lamps and double arm swivel projectors, complete with professional LED sources or for QR-CB 51, QR-LP 111, QPAR16 halogen/LED lamps. Fluorescent battens, complete with 50/60 Hz 230/240 V electronic power supply. LED batten with integrated driver. Can be completed with painted metal cover channel supplied in pre-punched stretched sheets for easy shaping by hand on site (occupied volume 110 times less than similar, already shaped channels). To be completed with end caps, opal white PC diffusing screens for LED linear light sources and fluorescent battens and mounting joints.

Sistema modular totalmente empotrado "trimless" con el que realizar cortes rectilíneos, a "L", cuadrados y rectangulares de ancho de 138 o 68 mm. en falso techo y en paredes de cartón-yeso, para iluminación directa e indirecta, difuso o concentrada. Compuesto de parejas de perfiles en estruso aluminio lineales, y en ángulos de 90° y módulos de cierre, de longitud predefinida y ajustables a la medida deseada, para fijar, estucar y enrasar en el cartón-yeso, donde colocar en el punto deseado: fuentes luminosas lineales LED o regletas para lámparas fluorescentes T16 y proyectores orientables de doble brazo, completos de fuentes luminosas led profesionales o lámparas halógenas/LED QR-CB51, QR-LP11, QPAR16. Regletas fluorescentes con alimentación electrónica 50/60Hz 230/240V. Reglette LED con alimentador incluido. Se pueden completar con módulos de cobertura en metal barnizado servido en planchas pre-agujereadas preparadas para una rápido ensamblaje a mano en la obra (volumen ocupado reducido de 110 veces respecto a productos similares ya ensamblados). Se complementa con tapas de cierre, difusores en PC blanco opal para fuentes de luz LED lineales y regletas fluorescentes y uniones de fijación.

**SISTEMA GUIDE**





SONNY BONO LODI - ITALY  
PHOTO R. MONTILLO













## COPPIA PROFILI RETTILINEI

COUPLE OF STRAIGHT ALUMINIUM PROFILE - PAREJA DE VÍAS RECTO

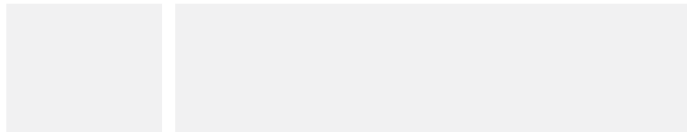
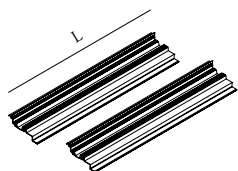

Lmm

500  
1000  
1500  
2000  
3000  
.....

CODE

LT2016  
LT2017  
LT2018  
LT2019  
LT2020  
LT20.misura\*

Completi di giunti lineari | linear joints included | pareja de conectores lineare incluido



## ANGOLO ESTERNO PER TAGLIO 138MM

EXTERIOR ANGLE FOR 138MM CUT- ÀNGULO EXTERIOR PARA CORTE 138MM

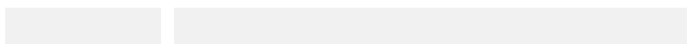

CODE

LT2012

Completi di giunti lineari | linear joints included | pareja de conectores lineare incluido



## ANGOLO ESTERNO PER TAGLIO DA 68 MM

EXTERIOR ANGLE FOR 68 MM CUT- ÀNGULO EXTERIOR PARA CORTE DE 68 MM

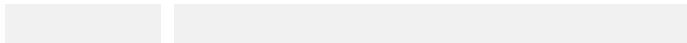
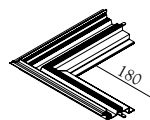

CODE

LT2012HS.68

Completi di giunti lineari | linear joints included | pareja de conectores lineare incluido



## ANGOLO INTERNO 68/138 MM

INTERIOR ANGLE 68/138 MM- ÀNGULO INTERIOR 68/138 MM

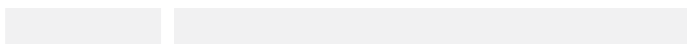

CODE

LT2011

Completi di giunti lineari | linear joints included | pareja de conectores lineare incluido



01 - bianco - white - blanco 02 - nero - black - negro

## COPPIA DI PROFILI PER PIANO INCLINATO LISCIO 30°

COUPLE OF PROFILES FOR SMOOTH INCLINED PLANE 30° - PAREJA DE PERFILS POR PLANO INCLINADO LISO 30°

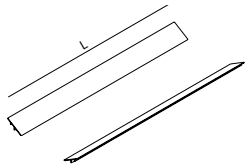

Lmm	CODE	Col.
1000	LT20PL.1000	01 02
1500	LT20PL.1500	01 02
2000	LT20PL.2000	01 02
3000	LT20PL.3000	01 02
500	LT20PL.500	01 02
.....	LT20PL.misura*	01 02

## PIANO INCLINATO LISCIO 30° PER ANGOLO ESTERNO 138MM

30° SMOOTH INCLINED PLANE FOR 138 MM. CUT EXTERIOR ANGLE- PERFIL POR PLANO INCLINADO LISO 30° POR AGULOS

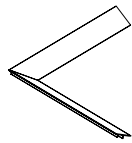

CODE	Col.
LT2012PL	01 02

## PIANO INCLINATO LISCIO 30° PER ANGOLO ESTERNO 68MM

30° SMOOTH INCLINED PLANE FOR 68 MM. CUT EXTERIOR ANGLE- PERFIL POR PLANO INCLINADO LISO 30° POR AGULOS

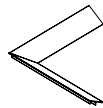

CODE	Col.
LT2012.68PL	01 02

## PIANO INCLINATO LISCIO 30° PER ANGOLO INTERNO

30° SMOOTH INCLINED PLANE FOR INTERIOR ANGLE- PERFIL POR PLANO INCLINADO LISO 30° POR AGULOS

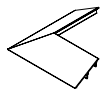

CODE	Col.
LT2011PL	01 02

\*Tramite questo codice è possibile ordinare il profilo in una lunghezza lineare non standard. Sostituire alla parola "misura" la lunghezza desiderata in mm. Per ordinare un profilo con una o entrambe le estremità tagliate ad angolo 45° aggiungere alla misura la lettera "D" (taglio Destro) o "S" (taglio Sinistro). Seguire istruzioni riportate a pag. 834. Per profili oltre i 3 mt e massimo 6 mt le condizioni di trasporto sono da concordare. |

\*Through this code it's possible to order the profile in a not-standard linear length. Replace the word "misura" with the desired length in mm. To order a profile with one or both ends 45° angle-cut add the letter "D" (right cut) or "S" (left cut) to the standard or custom length. Follow the instructions on page 834. For lengths over 3 mt. to max. 6 mt. transport conditions to negotiate. |

\*El uso de este código, se puede ordenar el perfil en un lineal longitud no estándar. Sustitúyase la palabra "medida" de la longitud en mm. Para pedir un perfil con uno o ambos extremos cortados en un ángulo de 45° a añadir a la medida de la letra "D" (derecha cortada) o "S" (izquierda cortada). Siga las instrucciones de la página. 834. Perfiles para más de 3 my 6 m Condiciones máximas de transporte a convenir.

01 - bianco - white - blanco 02 - nero - black - negro

## COPPIA TESTATA TELAIO

COUPLE OF HEAD-FRAMES- PAREJA DE TERMINALES

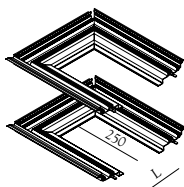

		L. taglio/cut/corte mm	CODE
		138	<b>LT2010</b>
		L. taglio/cut/corte mm	CODE
		68	<b>LT2010.68</b>

Una coppia di testate unite insieme formano una porzione di taglio da 500 mm | A couple of head-frames together cover a cut of 500 mm | Una pareja de cabezales juntos es para un corte de 500 mm



## COPPIA PIANO INCLINATO LISCIANO 30° PER TESTATE

COUPLE OF 30° SMOOTH INCLINED PLANES FOR HEAD-FRAMES- PAREJA PERFIL POR PLANO INCLINADO LISO 30° FOR TERMINALES

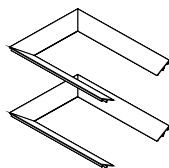

		L. taglio/cut/corte mm	L.mm	CODE	Col.
		138 x	500	<b>LT2010PL</b>	<b>01 02</b>
		68 x	500	<b>LT2010.68PL</b>	<b>01 02</b>

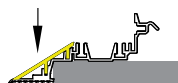
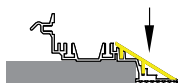

## GUIDE SISTEMA COPPIA GIUNTI LINEARI

STRAIGHT CONNECTOR COUPLE - PAREJA DE CONECTORES RECTOS



			CODE
			<b>LT2013</b>

Accessori non obbligatori. Necessari in caso di tagli in cantiere | Accessories not required. necessary in case of cuts on site | Accesorios no necesarios. necesaria en caso de corte en sitio de construcción

## GIUNTI D'ANGOLO COPPIA

GIUNTI D'ANGOLO COPPIA- ANGLE CONNECTOR COUPLE- CONECTORES ANGULARES PAREJA



			CODE
			<b>LT2014</b>

Accessori non obbligatori. Necessari in caso di tagli in cantiere | Accessories not required. necessary in case of cuts on site | Accesorios no necesarios. necesaria en caso de corte en sitio de construcción

01 - bianco - white - blanco 02 - nero - black - negro

## CANALE DI COPERTURA

METAL BOX COVER- CAJA METÁLICA

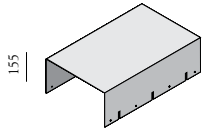

L. taglio/cut/corte mm	L.mm	CODE	Col.
138 x	300	<b>LT2031</b>	<b>01 02</b>
138 x	500	<b>LT2032</b>	<b>01 02</b>
138 x	700	<b>LT2033</b>	<b>01 02</b>
138 x	1000	<b>LT2034</b>	<b>01 02</b>
138 x	1200	<b>LT2035</b>	<b>01 02</b>
68 x	300	<b>LT2031.68</b>	<b>01 02</b>
68 x	500	<b>LT2032.68</b>	<b>01 02</b>
68 x	700	<b>LT2033.68</b>	<b>01 02</b>
68 x	1000	<b>LT2034.68</b>	<b>01 02</b>
68 x	1200	<b>LT2035.68</b>	<b>01 02</b>

Nella composizione dei canali considerare 100 mm in più per entrambe le estremità rispetto alla lunghezza di taglio che si vuole ottenere nel cartongesso (es. taglio da 1000 mm, canale da 1200mm) | For a perfect installation of the channel need to consider 100mm more for both side than the cut in the plasterboard (i.e. cut 1000 mm, channel 1200mm) | En la composición de los canales es necesario considerar 100 mm más para los dos lados del canal respecto al corte que de desea obtener en el cartón (ej. corte 1000 mm, canal 1200 mm)

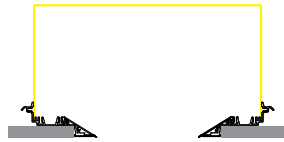

## CANALE D'ANGOLO

METAL BOX ANGLE COVER- CAJA METALICA ANGULAR

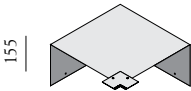

L. taglio/cut/corte mm	CODE	Col.
138	<b>LT2038</b>	<b>01 02</b>
68	<b>LT2038.68</b>	<b>01 02</b>

## COPPIA TESTATE CANALE

COUPLE OF METAL BOX COVER HEAD CLOSURES- PAR DE TERMINALES CANAL

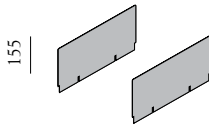

L. taglio/cut/corte mm	CODE	Col.
138	<b>LT2036</b>	<b>01 02</b>
68	<b>LT2036.68</b>	<b>01 02</b>

## COPPIA DI PARATIE INTERMEDIE CANALE FLUO DIRETTA

METAL CLOSURE FOR DIRECT FLUORESCENT BATTEN COUPLE- PAREJA DE TABIQUES INTERMEDIOS CANAL DIRECTO FLUORESCENTES

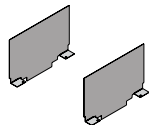

CODE	Col.
<b>LT2190</b>	<b>01 02</b>
<b>LT2190.68</b>	<b>01 02</b>

01 - bianco - white - blanco 02 - nero - black - negro



## SPOT FOCUS 55



LED	W	mA	K	lm product	lm/Led	CRI	∠	A	Dim.	H	CODE	Col.	
3SDCM 50000h L90 B10 ta 25°C <b>A+</b>	11	350	2700	931	1100	>90	29°	3.2	ø55	125	<b>GU004.927S 01 02</b>		
	11	350	2700	703	1100	>90	42°	3.2	ø55	125	<b>GU004.927F 01 02</b>		
	11	350	3000	1003	1185	>90	29°	3.2	ø55	125	<b>GU004.930S 01 02</b>		
	11	350	3000	757	1185	>90	42°	3.2	ø55	125	<b>GU004.930F 01 02</b>		
	11	350	4000	1088	1285	>90	29°	3.2	ø55	125	<b>GU004.940S 01 02</b>		
	11	350	4000	821	1285	>90	42°	3.2	ø55	125	<b>GU004.940F 01 02</b>		
QR-CB51 GU5,3 12V <b>A+-D</b>	W							A	Dim.	H	CODE	Col.	
	50							T.1	ø55	125	<b>GU001 01 02</b>		
QPAR16 GU10 230V <b>A+-D</b>	W								Dim.	H	CODE	Col.	
	50								ø55	125	<b>GU002 01 02</b>		

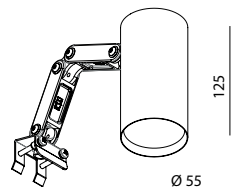

# SPOT FOCUS 90



LED

W	mA	K	lm product	lm/Led	CRI	∠	A	Dim.	H	Kg	CODE	Col.
17	500	2700	1438	1790	95	15°	5.4	ø90	110	0,94	GU005.927S	01 02
24,3	700	2700	1904	2370	95		7.3					
17	500	2700	1530	1790	95	24°	5.4	ø90	110	0,94	GU005.927F	01 02
24,3	700	2700	2011	2370	95		7.3					
17	500	2700	1609	1790	95	38°	5.4	ø90	110	0,94	GU005.927W	01 02
24,3	700	2700	2095	2370	95		7.3					
17	500	3000	1546	1925	95	15°	5.4	ø90	110	0,94	GU005.930S	01 02
24,3	700	3000	2045	2545	95		7.3					
17	500	3000	1645	1925	95	24°	5.4	ø90	110	0,94	GU005.930F	01 02
24,3	700	3000	2160	2545	95		7.3					
17	500	3000	1730	1925	95	38°	5.4	ø90	110	0,94	GU005.930W	01 02
24,3	700	3000	2250	2545	95		7.3					
17	500	4000	1699	2115	95	15°	5.4	ø90	110	0,94	GU005.940S	01 02
24,3	700	4000	2250	2800	95		7.3					
17	500	4000	1807	2115	95	24°	5.4	ø90	110	0,94	GU005.940F	01 02
24,3	700	4000	2376	2800	95		7.3					
17	500	4000	1901	2115	95	38°	5.4	ø90	110	0,94	GU005.940W	01 02
24,3	700	4000	2475	2800	95		7.3					
37,5	1050	2700	2547	3530	95	15°	10.1	ø90	110	0,94	GU006.927S	01 02
37,5	1050	2700	2692	3530	95	24°	10.1	ø90	110	0,94	GU006.927F	01 02
37,5	1050	2700	2817	3530	95	38°	10.1	ø90	110	0,94	GU006.927W	01 02
37,5	1050	3000	2731	3785	95	15°	10.1	ø90	110	0,94	GU006.930S	01 02
37,5	1050	3000	2886	3785	95	24°	10.1	ø90	110	0,94	GU006.930F	01 02
37,5	1050	3000	3020	3785	95	38°	10.1	ø90	110	0,94	GU006.930W	01 02
37,5	1050	4000	2998	4155	95	15°	10.1	ø90	110	0,94	GU006.940S	01 02
37,5	1050	4000	3168	4155	95	24°	10.1	ø90	110	0,94	GU006.940F	01 02
37,5	1050	4000	3315	4155	95	38°	10.1	ø90	110	0,94	GU006.940W	01 02

3SDCM  
50000h L90  
B10 ta 25°

A+



Installabile solo su taglio l. 138 mm | Fitting only on the cut mm138 wide | Instalable sólo sobre corte l. 138 mm

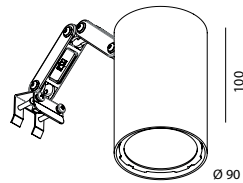

accessori - accessories  
accesorios pag. 414

01 - bianco - white - blanco 02 - nero - black - negro



pag.824



pag.820

## SPOT QR-CB 51



QR-CB51	W	A	Dim.	H	CODE	Col.	
1x max 50		T.1	ø63	66	LT2051	01 02	 

la sorgente led deve avere un'altezza totale non superiore a 45mm | leD source must have a heigh not more than 45mm | la fuente leD debe tener una altura de no más de 45 mm

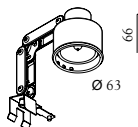

## SPOT QR-LP 111



QR-LP 111	W	A	Dim.	H	CODE	Col.	
1x max 60		T.2	ø111	72	GU007	01 02	 

Installabile solo su taglio l. 138 mm | Fitting only on the cut mm 138 wide | Instalable sólo sobre corte l. 138 mm

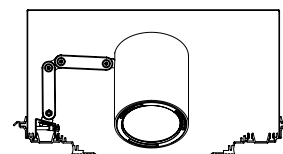
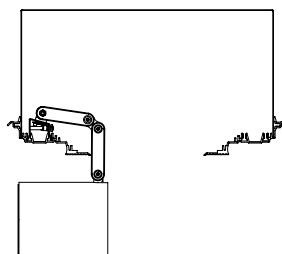
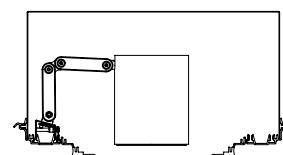
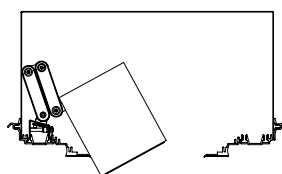
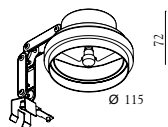

01 - bianco - white - blanco 02 - nero - black - negro

## GUIDE SISTEMA REGLETTE LED 138MM 41W/MT

41W/MT LED BATTEN FOR 138 MM. CUT - REGLETTE LED 138MM 41W/MT

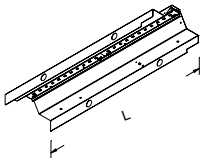

	W	K	Im product	Im/Led	CRI	DaliT&D	Lmm	CODE	
LINEAR LED 41W/MT 4640lm/MT CRI90	22,8	3000	2600	2600	90		565	<b>RLG13811</b>	
	22,8	3000	2600	2600	90	x	565	<b>RLG13811D</b>	
	34,2	3000	3900	3900	90		845	<b>RLG13813</b>	
	34,2	3000	3900	3900	90	x	845	<b>RLG13813D</b>	
	45,6	3000	5200	5200	90		1125	<b>RLG13815</b>	
	45,6	3000	5200	5200	90	x	1125	<b>RLG13815D</b>	
	57	3000	6500	6500	90		1405	<b>RLG13817</b>	
	57	3000	6500	6500	90	x	1405	<b>RLG13817D</b>	
	<b>A+</b>								

	W	K	Im product	Im/Led	CRI	DaliT&D	Lmm	CODE	
LINEAR LED 41W/MT 4820lm/MT CRI90	22,8	4000	2700	2700	90		565	<b>RLG13812</b>	
	22,8	4000	2700	2700	90	x	565	<b>RLG13812D</b>	
	34,2	4000	4050	4050	90		845	<b>RLG13814</b>	
	34,2	4000	4050	4050	90	x	845	<b>RLG13814D</b>	
	45,6	4000	5400	5400	90		1125	<b>RLG13816</b>	
	45,6	4000	5400	5400	90	x	1125	<b>RLG13816D</b>	
	57	4000	6750	6750	90		1405	<b>RLG13818</b>	
	57	4000	6750	6750	90	x	1405	<b>RLG13818D</b>	

alimentatore incluso | included ballast | con trasformador

## REGLETTE FLUO DIRETTA BI L.138 MM

DOUBLE-LAMP FLUO BATTEN - BI FLUORESCENTE DIRECTA

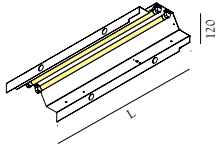

	W	DaliT&D	Lmm	CODE	
T16	2x14-24		575	<b>LT2071</b>	
	2x14-24	x	575	<b>LT2071D</b>	
	2x21-39		875	<b>LT2073</b>	
	2x21-39	x	875	<b>LT2073D</b>	
	2x28-54		1175	<b>LT2075</b>	
	1x28-54	x	1175	<b>LT2075D</b>	
	2x35-49		1475	<b>LT2077</b>	
	2x35-49	x	1475	<b>LT2077D</b>	
	2x80		1475	<b>LT2078</b>	
	2x80	x	1475	<b>LT2078D</b>	
<b>A+-A</b>					

Alimentazione elettronica. Installabile solo su taglio larg. 138 mm | Electronica ballast. Fitting only on the cut mm 138 wide | Balasto electrónico. Instalable sólo sobre corte l. 138 mm

## REGLETTE LED 68MM 24W/MT

24W/MT LED BATTEN FOR 68MM. CUT REGLETTE LED 68MM 24W/MT

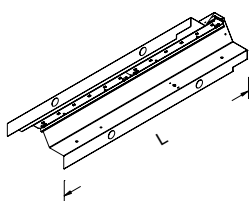

	W	K	lm product	lm/Led	CRI	DaliT&D	Lmm	CODE	
LINEAR LED 24W/MT 2200lm/MT CRI>80 230V	12,8	3000	1232	1232	>80		565	<b>RLG6801</b>	
	12,8	3000	1232	1232	>80	x	565	<b>RLG6801D</b>	
	19,2	3000	1848	1848	>80		845	<b>RLG6803</b>	
	19,2	3000	1848	1848	>80	x	845	<b>RLG6803D</b>	
	25,6	3000	2464	2464	>80		1125	<b>RLG6805</b>	
	25,6	3000	2464	2464	>80	x	1125	<b>RLG6805D</b>	
	32	3000	3080	3080	>80		1405	<b>RLG6808</b>	
	32	3000	3080	3080	>80	x	1405	<b>RLG6808D</b>	
	50000h Ta 25° L70B10	A+							

	W	K	lm product	lm/Led	CRI	DaliT&D	Lmm	CODE	
LINEAR LED 24W/MT 2285lm/MT CRI>80	12,8	4000	1280	1280	>80		565	<b>RLG6802</b>	
	12,8	4000	1280	1280	>80	x	565	<b>RLG6802D</b>	
	19,2	4000	1920	1920	>80		845	<b>RLG6804</b>	
	19,2	4000	1920	1920	>80	x	845	<b>RLG6804D</b>	
	25,6	4000	2560	2560	>80		1125	<b>RLG6806</b>	
	25,6	4000	2560	2560	>80	x	1125	<b>RLG6807D</b>	
	32	4000	3200	3200	>80		1405	<b>RLG6809</b>	
	32	4000	3200	3200	>80	x	1405	<b>RLG6809D</b>	
	50000h Ta 25° L70B10	A+							

alimentatore incluso | included ballast | con trasformador

## REGLETTE LED 68MM 41W/MT

41W/MT LED BATTEN FOR 68MM. CUT - REGLETTE LED 68MM 41W/MT

	W	K	lm product	lm/Led	CRI	DaliT&D	Lmm	CODE	
LINEAR LED 41W/MT 4640lm/MT CRI90	22,8	3000	2600	2600	90		565	<b>RLG6830</b>	
	22,8	3000	2600	2600	90	x	565	<b>RLG6830D</b>	
	34,2	3000	3900	3900	90		845	<b>RLG6832</b>	
	34,2	3000	3900	3900	90	x	845	<b>RLG6832D</b>	
	45,6	3000	5200	5200	90		1125	<b>RLG6834</b>	
	45,6	3000	5200	5200	90	x	1125	<b>RLG6835D</b>	
	57	3000	6500	6500	90		1405	<b>RLG6837</b>	
	57	3000	6500	6500	90	x	1405	<b>RLG6837D</b>	
	A+								

	W	K	lm product	lm/Led	CRI	DaliT&D	Lmm	CODE	
LINEAR LED 41W/MT 4820lm/MT CRI90	22,8	4000	2700	2700	90		565	<b>RLG6831</b>	
	22,8	4000	2700	2700	90	x	565	<b>RLG6831D</b>	
	34,2	4000	4050	4050	90		845	<b>RLG6833</b>	
	34,2	4000	4050	4050	90	x	845	<b>RLG6833D</b>	
	45,6	4000	5400	5400	90		1125	<b>RLG6836</b>	
	45,6	4000	5400	5400	90	x	1125	<b>RLG6836D</b>	
	57	4000	6750	6750	90		1405	<b>RLG6838</b>	
	57	4000	6750	6750	90	x	1405	<b>RLG6838D</b>	
	A+								

alimentatore incluso | included ballast | con trasformador

## DIFFUSORE PER MODULO LED DIRETTA 138MM.

DIFFUSER FOR FLUORESCENT BATTEN 138MM.- DIFUSOR PARA REGLETTE FLUO DIRECTO 138 MM.

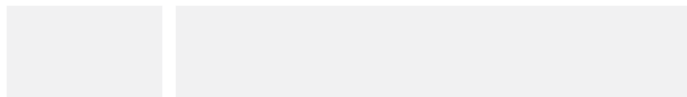
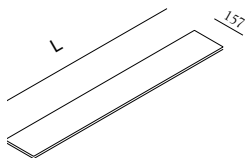

Dim.	Lmm
138	565
138	845
138	1125
138	1405

CODE  
**LT2080L**  
**LT2081L**  
**LT2082L**  
**LT2083L**

## DIFFUSORE PER MODULO FLUO DIRETTA 138MM.

DIFFUSER FOR FLUORESCENT BATTEN 138MM.- DIFUSOR PARA REGLETTE FLUO DIRECTO 138 MM.

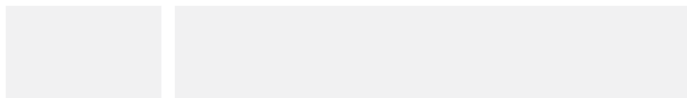
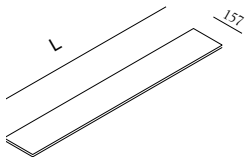

Dim.	Lmm
138	575
138	875
138	1175
138	1475

CODE  
**LT2080**  
**LT2081**  
**LT2082**  
**LT2083**

## DIFFUSORE PER MODULO LED DIRETTO 68MM.

DIFFUSER FOR FLUORESCENT BATTEN 68MM.- DIFUSOR PARA ELEMENTO FLUORESCENTE DIRECTO 68MM.

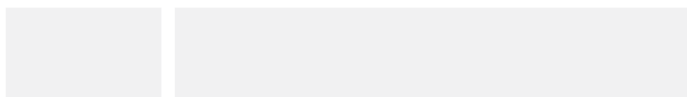
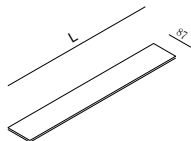

Dim.	Lmm
68	575
68	875
68	1175
68	1475

CODE  
**LT2080.68L**  
**LT2081.68L**  
**LT2082.68L**  
**LT2083.68L**

## DIFFUSORE PER MODULO FLUO DIRETTO 68MM.

DIFFUSER FOR FLUORESCENT BATTEN 68MM.- DIFUSOR PARA ELEMENTO FLUORESCENTE DIRECTO 68MM.

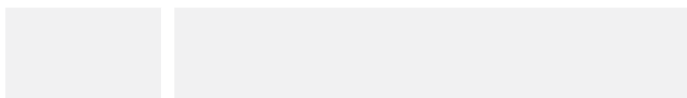
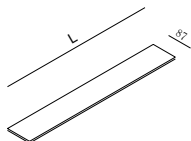

Dim.	Lmm
68	575
68	875
68	1175
68	1475

CODE  
**LT2080.68**  
**LT2081.68**  
**LT2082.68**  
**LT2083.68**

## LENTE CON ANELLO

LENSES WITH RING - LENTES CON ANILLO



LENTE SATINATA CON ANELLO / SATIN LENS WITH RING / LENTE SATINADA CON ANILLO

Dim. Kg CODE Col.  
 Ø 85 0,02 **L085SA** 01 02



LENTE FRESNEL CON ANELLO / FRESNEL LENS WITH RING / LENTE FRESNEL CON ANILLO

Dim. Kg CODE Col.  
 Ø 85 0,02 **L085FA** 01 02



LENTE ELISSOIDALE CON ANELLO / ELIPSOID LENS WITH RING / LENTE ELIPSOIDAL CON ANILLO

Dim. Kg CODE Col.  
 Ø 85 0,02 **L085EA** 01 02



LENTE ASIMMETRICA CON ANELLO / ASYMMETRIC LENS WITH RING / LENTE ASIMÉTRICA CON ANILLO

Dim. Kg CODE Col.  
 Ø 85 0,02 **L085AA** 01 02



FILTRO NIDO D'APE CON ANELLO / HONEY COMB LOUVER WITH RING / REJILLA DE NIDO DE ABEJA CON ANILLO

Dim. Kg CODE Col.  
 Ø 85 0,02 **L085RA** 01 02



## LENTI

LENSES - LENTES



LENTE FRESNEL / FRESNEL LENS / LENTE FRESNEL

Dim. Kg CODE  
 Ø 50 0,02 **L050F**



LENTE ELISSOIDALE / ELIPSOID LENS / LENTE ELIPSOIDAL

Dim. Kg CODE  
 Ø 50 0,02 **L050E**



LENTE ASIMMETRICA / ASYMMETRIC LENS / LENTE ASIMÉTRICA

Dim. Kg CODE  
 Ø 50 0,02 **L050A**



FILTRO NIDO D'APE / HONEY COMB LOUVER / REJILLA DE NIDO DE ABEJA

Dim. Kg CODE  
 Ø 50 0,02 **L050R**



Adatto a tutti i tipi di sorgenti / Suitable for all sources

Con l'utilizzo di questa lente varia il grado di protezione del prodotto da IP54 a IP20 / The use of this lens varies the degree of protection from IP54 to IP20.





PARQUET DIFFUSION IMOLA - ITALY  
PHOTO D.DOMENICALI

## INCASSI • DOWNLIGHTERS • EMPOTRADO RANGE

CI p.418



NYX p.426



TWENTY7 p.426



LIGHT DRUM p.486



MOVE p.488



INCAS SPOT & DIFFUSED p.506



MINI INCAS p.524



MINIFRAME p.538



HIDE SYSTEM p.544



INCAS 45-90 p.552



STEP p.558



WINDOW p.564



---

Apparecchio da incasso a parete e soffitto, fisso per sorgente LED integrata o per lampade alogene/LED QR-CB 35, QR-CB 51, QR-LP 111 12V/230V , QPAR16 230V/240V. Alimentazione remota disponibile come accessorio. Corpo, cornice di battuta super-slim larghezza 18 mm e gruppo ottico in metallo verniciato o cromato. Installabile anche in pareti e soffitti in calcestruzzo mediante apposita cassaforma in lamiera zincata o in alluminio disponibile come accessorio. Grado di protezione IP20.

Recessed downlight for wall and ceiling installation, fix or adjustable for integrated LED source or for halogen/LED QR-CB 35, QR-CB 51, QR-LP 111 12V/230V, QPAR16 lamps. Remote power supply available as an accessory. Body, super-slim 18mm. width frame and optic group in painted or chromed metal. It can also be installed in concrete or brick walls through specific galvanized steel or aluminium made wall-box, available as an accessory. Degree of protection IP20.

Lampara emportable por la pared y el techo, fijo o ajustable para bombilla LED integrada o halogeno/ /LED QR-CB 35, QR-CB 51, QR-LP 111 12V/230V , QPAR16. Reactancia remota disponible como accesorio. Cuerpo y marco super-slim, ancho 18mm y optica en metal pintado o cromado. Tambien puede ser instalado en paredes y techos de hormigon usando una caja en lamina de zinc o de aluminio, disponible como accesorio. Grado de proteccion IP20.

---

CI







CASCIOLI CONCESSIONARIA BMW SAN BENEDETTO DEL TRONTO - ITALY  
PHOTO ER STUDIO





## CI35 FISSO

FXED - FIJO

Ø 56



	W	mA	K	lm product	lm/Led	CRI	∠	A	Dim.	Lmm	Kg	CODE	Col.	
LED	5	500	3000	310	395	95	22°	5.1	ø64	75	0.13	LT1167930S	01 02 12	CE, A+, IP23, A, II
50000h L90 B10 ta 25°C	A+													
QR-CB35 GU4 12V	1x max 35							A	Dim.	Lmm	Kg	CODE	Col.	
	1x max 35							T.1	ø64	60	0.20	LT1167	01 02 12	CE, A+, IP23, A, II

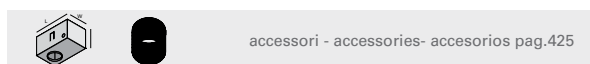

accessori - accessories- accesorios pag.425

## CI50 FISSO

FXED - FIJO

Ø 70



	W	mA	K	lm product	lm/Led	CRI	∠	A	Dim.	Lmm	CODE	Col.			
LED	6,8	350	3000	330	494	>90	24°	3.1	ø78	130	LT1165.930F	01 02 12	CE, A+, IP23, A, II		
	6,8	350	3000	450	494	>90	36°	3.1	ø78	130	LT1165.930W	01 02 12			
	6,8	350	4000	363	544	>90	24°	3.1	ø78	130	LT1165.940F	01 02 12			
	6,8	350	4000	496	544	>90	36°	3.1	ø78	130	LT1165.940W	01 02 12			
3SDCM 50000h L90 B10 ta 25°C	A+														
LED	11	350	2700	931	1100	>90	29°	3.2	ø78	130	LT1164.927S	01 02 12	CE, A+, IP23, A, II		
	11	350	2700	703	1100	>90	42°	3.2	ø78	130	LT1164.927F	01 02 12			
	11	350	3000	1003	1185	>90	29°	3.2	ø78	130	LT1164.930S	01 02 12			
	11	350	3000	757	1185	>90	42°	3.2	ø78	130	LT1164.930F	01 02 12			
	11	350	4000	1088	1285	>90	29°	3.2	ø78	130	LT1164.940S	01 02 12			
	11	350	4000	821	1285	>90	42°	3.2	ø78	130	LT1164.940F	01 02 12			
3SDCM 50000h L90 B10 ta 25°C	A+														
QR-CB51 GU5,3 12V	1 x max 50							A	Dim.	Lmm	CODE	Col.			
	1 x max 50							T.1	ø78	75	LT1164	01 02 12	CE, A+, IP23, A, II		
OPAR16 GU10 230V	1 x max 50							Dim.	Lmm	CODE	Col.				
	1 x max 50							ø78	75	LT1165	01 02 12	A+, IP23, CE			

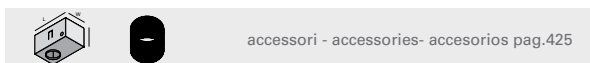
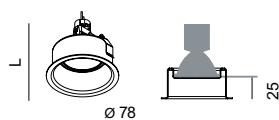

accessori - accessories- accesorios pag.425

## CI35 ORIENTABILE

DIRECTIONAL - AJUSTABLE



	W	mA	K	lm product	lm/Led	CRI	∠
LED	5	500	3000	310	395	95	22°
50000h L90 B10 ta 25°C	<b>A+</b>						
QR-CB35 GU4 12V	1 x max 35						
	<b>A+-D</b>						

A	Dim.	H	α	Kg	CODE	Col.
<b>5.1</b>	ø64	75	10	0,12	<b>LT1163.930S</b>	<b>01 02 03 12</b>
<b>1.1</b>	ø64	60	20	0,20	<b>LT1163</b>	<b>01 02 03 12</b>

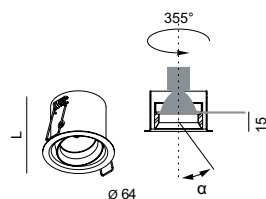

accessori - accessories - accesorios pag.425

## CI50 ORIENTABILE

DIRECTIONAL - AJUSTABLE



	W	mA	K	lm product	lm/Led	CRI	∠
LED	6,8	350	3000	330	494	>90	24°
	6,8	350	3000	450	494	>90	36°
3SDCM 50000h L90 B10 ta 25°C	<b>A+</b>						
	6,8	350	4000	363	544	>90	24°
	6,8	350	4000	496	544	>90	36°
LED	11	350	2700	931	1100	>90	29°
	11	350	2700	703	1100	>90	42°
	11	350	3000	1003	1185	>90	29°
	11	350	3000	757	1185	>90	42°
3SDCM 50000h L90 B10 ta 25°C	<b>A+</b>						
	11	350	4000	1088	1285	>90	29°
	11	350	4000	821	1285	>90	42°
QR-CB51 GU5,3 12V	1 x max 50						
	<b>A+-D</b>						
QPAR16 GU10 230V	1 x max 50						
	<b>A+-D</b>						

A	Dim.	Lmm	α	CODE	Col.
<b>3.1</b>	ø78	110	15	<b>LT1161.930F</b>	<b>01 02 03 12</b>
<b>3.1</b>	ø78	110	15	<b>LT1161.930W01</b>	<b>02 03 12</b>
<b>3.1</b>	ø78	110	15	<b>LT1161.940F</b>	<b>01 02 03 12</b>
<b>3.1</b>	ø78	110	15	<b>LT1161.940W01</b>	<b>02 03 12</b>
<b>3.2</b>	ø78	130	15	<b>LT1160.927S</b>	<b>01 02 03 12</b>
<b>3.2</b>	ø78	130	15	<b>LT1160.927F</b>	<b>01 02 03 12</b>
<b>3.2</b>	ø78	130	15	<b>LT1160.930S</b>	<b>01 02 03 12</b>
<b>3.2</b>	ø78	130	15	<b>LT1160.930F</b>	<b>01 02 03 12</b>
<b>3.2</b>	ø78	130	15	<b>LT1160.940S</b>	<b>01 02 03 12</b>
<b>3.2</b>	ø78	130	15	<b>LT1160.940F</b>	<b>01 02 03 12</b>
<b>1.1</b>	ø78	80		<b>LT1160</b>	<b>01 02 03 12</b>
	ø78	90		<b>LT1161</b>	<b>01 02 03 12</b>

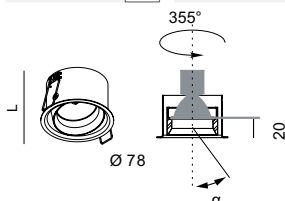

accessori - accessories - accesorios pag.425

01 - bianco - white - blanco

02 - nero - black - negro

12 - grigio - grey - gris

03 - cromo - chrome - cromo



pag.824



pag.820

# CI 111 ORIENTABILE

DIRECTIONAL - AJUSTABLE



QR-LP 111 G53 12V



B→C

W

1xmax100

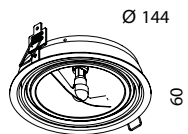
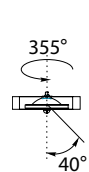

A	Dim.	H	Kg	CODE	Col.
T.2	ø144	60	0.23	LT6000	01 02 12



accessori - accessories- accesorios pag.425

01 - bianco - white - blanco 02 - nero - black - negro 12 - grigio - grey - gris

## CASSAFORMA CI35 E CI50

WALLBOX - CAJA

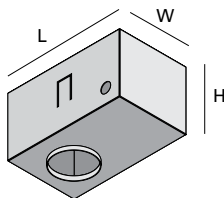

	CI35 CI50	Dim.	H	CODE
		190 x 114	80	LT9061
		208 x 125	120	LT9062

Cassaforma in lamiera zincata per installazione in laterizio o calcestruzzo - galvanized metal wallbox for installing in brick or reinforced concrete - caja de metal galvanizado para instalar en ladrillo o de hormigón armado.

## CASSAFORMA IN LAMIERA MICROFORATA CI35E CI50

WALLBOX - CAJA



	CI35 CI50	Dim.	H	CODE
		ø50	ø70	LT9061C
				LT9062C

Cassaforma in lamiera microforata per installazione in laterizio o calcestruzzo - galvanized metal wallbox for installing in brick or reinforced concrete - caja de metal galvanizado para instalar en ladrillo o de hormigón armado

## CASSAFORMA CI111

WALLBOX - CAJA

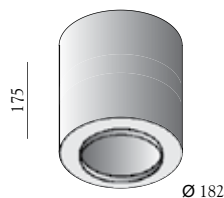

	CI111	Dim.	H	CODE
		ø182	175	LT6000.CC

Cassaforma in lamiera zincata per installazione in laterizio o calcestruzzo - galvanized metal wallbox for installing in brick or reinforced concrete - caja de metal galvanizado para instalar en ladrillo o de hormigón armado.

Apparecchio da incasso a soffitto, rasato a scomparsa totale, trimless, di forma tonda e quadrata, fisso e orientabile, per illuminazione d'accento o diffusa. Sorgente luminosa in posizione arretrata antiabbagliamento. Gruppo ottico orientabile di 355° sull'asse verticale e di +/- 20° su quello orizzontale. Disponibile nelle versioni per installazione in cartongesso o in laterizio e calcestruzzo. Con sorgente LED integrata o per lampade alogene/led QR-CB 35, QR-CB 51 e QR-LP 111 12V/230V, QPAR16 230V/240V. Nella versione led integrato riflettore metallizzato in alluminio puro 99,9%. Corpo e gruppo ottico in alluminio verniciato. Alimentazione remota disponibile come accessorio. Grado di protezione IP20/IP23/IP54.

Round or square, fix or directional, trimless recessed downlight for ceiling installation, for accent or diffused lighting. Light source in recessed position for anti-glare lighting. Available both in plasterboard false-ceiling and in concrete/brick wall installation version. For integrated LED source or for 12V/230V QR-CB 35, QR-CB 51 and QR-LP 111 or 230V QPAR16 GU10 halogen/led lamps . Body and optical group in painted aluminum. Version with Integrated Chip On Board LED source provided with 99,99% pure aluminum coated reflector. Directional versions: optical group adjustable 355° horizontally and +/- 20° vertically. Remote power-supply available as an accessory. Degree of protection IP20/IP23/IP54.

Aparato para empotrar en el techo con marco de tope, fijo y orientable, para iluminación de realce o difusa. Fuente luminosa con posición retrasada antideslumbramiento. Grupo óptico orientable de 355° en el eje vertical y de +/- 20° en el horizontal. Disponible en las versiones para instalación en placas de yeso o en ladrillo y hormigón. Con fuente LED Chip On Board integrada o para lámparas halógenas/led QR-CB 35, QR-CB 51 y QPAR16 230V/240V. n la versión led integrado reflector metalizado de aluminio puro 99,9%. Cuerpo y grupo óptico de aluminio pintado. Alimentación remota disponible como accesorio. Grado de protección IP20/IP23/IP54.

NYX



DOWLIGHTERS







## NYX RANGE



### NYX TRIMLESS

NYX è una gamma di apparecchi da incasso, fissi e orientabili, declinata nelle versioni a scomparsa totale, con cornice di battuta e nell'originale veste TUBE, dotata di un cilindro estraibile che permette di scegliere tra diverse configurazioni estetiche. La gamma è proposta nelle forme quadrata e tonda, in un'ampia scelta di dimensioni. Sono previsti sia led integrati che portalampada per sorgenti alogene e led.

NYX is a range of recessed, fixed and directional lights, provided in fully recessed versions, with an extruded profile and in the original TUBE form, with a removable cylinder to let you choose between different aesthetic configurations.

The range comes in square and round shapes, with a wide choice of sizes. The products are designed for integrated LED and halogen sockets for LED and halogen sources.



**NYX FRAME**



**NYX  
DIFFUSED**



**NYX  
TUBE**

## NYX TRIMLESS



# NYX Q35

FIXED - FIJO

54x54 Ø 40



	W	mA	K	lm product	lm/Led	CRI	∠	A	Dim.	H	Kg	CODE	Col.	
LED	5	500	3000	310	395	95	22°	5.1	50x50	90	0,18	LTN01.930F	01 02 49	CE IP20 LED 12V AC
50000h L90 B10 ta 25°C	solo per cartongesso - for plasterboard only - solo para cartón													
QR-CB35 GU4 12V	1 x max 35 per cartongesso/for plasterbord/para a cartón							1.1	50x50	90	0,12	LTN05	01 02 49	IP20 LED 12V AC
	1 x max 35 per laterizio/for brick wall							1.1	100x100	100	0,45	LTN06	01 02 49	

Nella versione laterizio il trasformatore è da installare remoto | For the brick wall version it is necessary to fit the ballast outside | En la versión en ladrillos es necesario instalar el transformator en remoto

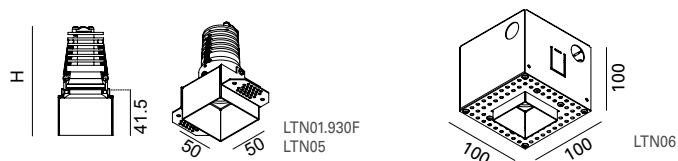

# NYX Q50

FIXED - FIJO

74x74 Ø 55



	W	mA	K	lm product	lm/Led	CRI	∠	A	Dim.	H	Kg	CODE	Col.	
LED	6,8	350	3000	330	494	>90	24°	3.1	70x70	115	0,29	LTN08.930F	01 02 49	CE IP20 LED 12V AC
	6,8	350	3000	450	494	>90	36°	3.1	70x70	115	0,29	LTN08.930W	01 02 49	
	6,8	350	4000	363	544	>90	24°	3.1	70x70	115	0,29	LTN08.940F	01 02 49	
	6,8	350	4000	496	544	>90	36°	3.1	70x70	115	0,29	LTN08.940W	01 02 49	
3SDCM 50000h L90 B10 ta 25°C	solo per cartongesso - for plasterboard only - solo para cartón													
QR-CB51 GU5,3 12V	1 x max 50 per cartongesso/for plasterbord/para a cartón							1.1	70x70	95	0,19	LTN14	01 02 49	IP20 LED 12V AC
	1 x max 50 per laterizio/for brick wall/para ladrillo							1.1	150x120	120	0,87	LTN15	01 02 49	
OPAR16 GU10 230V	1 x max 50 per cartongesso/for plasterbord/para a cartón								70x70	105	0,19	LTN16	01 02 49	IP20 LED 230V AC
	1 x max 50 per laterizio/for brick wall								150x120	120	0,93	LTN17	01 02 49	

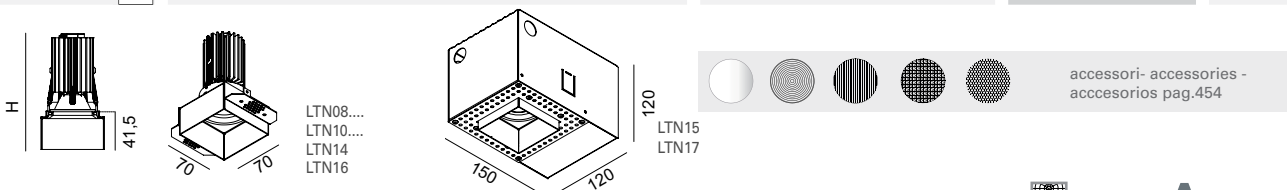

pag.824 A pag.820

01 - bianco - white - blanco 02 - nero - black - negro 49 - moka

DOWNLIGHTERS

## NYX T35F

FIXED - FIJO



	W	mA	K	lm product	lm/Led	CRI	∠	A	Dim.	H	Kg	CODE	Col.	
LED	5	500	3000	310	395	95	22°	5.1	Ø40	80	0,19	LTN30.930F	01 02 49	
50000h L90 B10 ta 25°C	<b>A+</b> solo per cartongesso - for plasterboard only - solo para cartòn													
OR-CB35 GU4 12V	1 x max 35 per cartongesso/for plasterbord/para a cartòn							A	Dim.	H	Kg	CODE	Col.	
	1 x max 35 per laterizio/for brick wall/para ladrillo							1.1	Ø40	80	0,16	LTN34	01 02 49	
								1.1	100x100	100	0,24	LTN35	01 02 49	

Nella versione laterizio il trasformatore è da installare remoto | For the brick wall version it is necessary to fit the ballast outside | En la version en ladrillo es necesario instalar el transformador en remoto



## NYX T50F

FIXED - FIJO



	W	mA	K	lm product	lm/Led	CRI	∠	A	Dim.	H	Kg	CODE	Col.	
LED	6,8	350	3000	330	494	>90	24°	3.1	Ø55	105	0,28	LTN48.930F	01 02 49	
	6,8	350	3000	450	494	>90	36°	3.1	Ø55	105	0,28	LTN48.930W	01 02 49	
	6,8	350	4000	363	544	>90	24°	3.1	Ø55	105	0,28	LTN48.940F	01 02 49	
	6,8	350	4000	496	544	>90	36°	3.1	Ø55	105	0,28	LTN48.940W	01 02 49	
3SDCM 50000h L90 B10 ta 25°C	<b>A+</b> solo per cartongesso - for plasterboard only - solo para cartòn													
OR-CB51 GU5,3 12V	1 x max 50 per cartongesso/for plasterbord/para a cartòn							A	Dim.	H	Kg	CODE	Col.	
	1 x max 50 per laterizio/for brick wall/para ladrillo							1.1	Ø55	85	0,20	LTN54	01 02 49	
								1.1	150x120	120	0,89	LTN55	01 02 49	
OPAR16 GU10 230V	1 x max 50 per cartongesso/for plasterbord/para a cartòn							Dim.	H	Kg	CODE	Col.		
	1 x max 50 per laterizio/for brick wall/para ladrillo							Ø55	95	0,21	LTN56	01 02 49		
								150x120	120	0,84	LTN57	01 02 49		

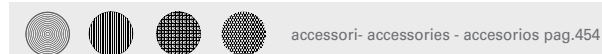

# NYX T35D

DIRECTIONAL - AJUSTABLE



	W	mA	K	lm product	lm/Led	CRI	∠	A	Dim.	H	Kg	CODE	Col.	
LED	5	500	3000	310	395	95	22°	5.1	ø55	70	0,23	LTN40.930F	01 02 49	
50000h L90 B10 ta 25°C <b>A+</b>	solo per cartongesso - for plasterboard only - solo para cartón													
	W							A	Dim.	H	Kg	CODE	Col.	
QR-CB35 GU4 12V	1 x max 35 per cartongesso/for plasterbord/para a cartón							T.1	ø55	70	0,20	LTN44	01 02 49	
	1 x max 35 per laterizio/for brick wall/para ladrillo							T.1	100x100	100	0,40	LTN45	01 02 49	
<b>A+-D</b>	Nella versione laterizio il trasformatore è da installare a remoto   For the brick wall version it is necessary to fit the ballast outside   En la version en ladrillo es necesario instalar el transformador en remoto													

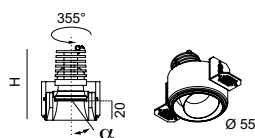

LTN40....  
LTN44

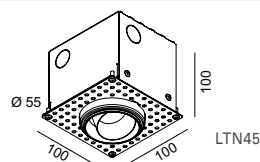

LTN45

# NYX T50D

DIRECTIONAL - AJUSTABLE



	W	mA	K	lm product	lm/Led	CRI	∠	A	Dim.	H	α	Kg	CODE	Col.	
LED	6,8	350	3000	330	494	>90	24°	3.1	ø70	110	20	0,55	LTN58.930F	01 02 49	
	6,8	350	3000	450	494	>90	36°	3.1	ø70	110	20	0,55	LTN58.930W	01 02 49	
	6,8	350	4000	363	544	>90	24°	3.1	ø70	110	20	0,55	LTN58.940F	01 02 49	
	6,8	350	4000	496	544	>90	36°	3.1	ø70	110	20	0,55	LTN58.940W	01 02 49	
	11	350	2700	931	1100	>90	29°	3.2	ø70	115	20	0,38	LTN60.927S	01 02 49	
	11	350	2700	703	1100	>90	42°	3.2	ø70	115	20	0,38	LTN60.927F	01 02 49	
	11	350	3000	1003	1185	>90	29°	3.2	ø70	115	20	0,38	LTN60.930S	01 02 49	
	11	350	3000	757	1185	>90	42°	3.2	ø70	115	20	0,38	LTN60.930F	01 02 49	
	11	350	4000	1088	1285	>90	29°	3.2	ø70	115	20	0,38	LTN60.940S	01 02 49	
	11	350	4000	821	1285	>90	42°	3.2	ø70	115	20	0,38	LTN60.940F	01 02 49	
3SDCM 50000h L90 B10 ta 25°C <b>A+</b>	solo per cartongesso - for plasterboard only - solo para cartón														
	W							A	Dim.	H	α <td>Kg <td>CODE <td>Col. <td></td> </td></td></td>	Kg <td>CODE <td>Col. <td></td> </td></td>	CODE <td>Col. <td></td> </td>	Col. <td></td>	
QR-CB51 GU5,3 12V	1 x max 50 per cartongesso/for plasterbord/para a cartón							T.1	ø70	80	20	0,32	LTN64	01 02 49	
	1 x max 50 per laterizio/for brick wall							T.1	150x120	125	20	0,90	LTN65	01 02 49	
<b>A+-D</b>	Nella versione laterizio il trasformatore è da installare a remoto   For the brick wall version it is necessary to fit the ballast outside   En la version en ladrillo es necesario instalar el transformador en remoto														
	W							Dim.	H	α <td>Kg <td>CODE <td>Col. <td></td> </td></td></td>	Kg <td>CODE <td>Col. <td></td> </td></td>	CODE <td>Col. <td></td> </td>	Col. <td></td>		
OPAR16 GU10 230V	1 x max 50 per cartongesso/for plasterbord/para a cartón							ø70	90	20	0,27	LTN66	01 02 49		
	1 x max 50 per laterizio/for brick wall/para ladrillo							150x120	125	20	0,91	LTN67	01 02 49		

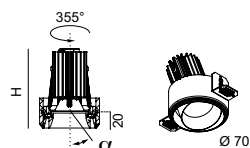

LTN58....  
LTN60....  
LTN64  
LTN66

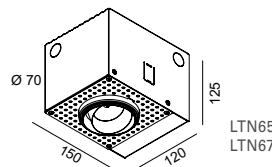

LTN65  
LTN67

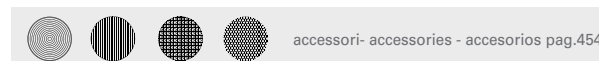

accessori- accessories - accesorios pag.454



## NYX T80F

FIXED FIJO



	W	mA	K	lm product	lm/Led	CRI	∠	A	Dim.	H	Kg	CODE	Col.		
	17	500	3000	1546	1925	95	15°	5.4	ø90	165	0,80	LTN20.930S	01 02 49		
	24,3	700	3000	2045	2545	95		7.3							
	17	500	3000	1645	1925	95		5.4							
	3SDCM 50000h L90 B10 ta 25°C	24,3	700	3000	2160	2545	95	24°	5.4	ø90	165	0,80	LTN20.930F	01 02 49	
		17	500	3000	1730	1925	95		7.3						
		24,3	700	3000	2250	2545	95		5.4						
	A+	17	500	4000	1699	2115	95	38°	5.4	ø90	165	0,80	LTN20.930W	01 02 49	
		24,3	700	4000	2250	2800	95		7.3						
		17	500	4000	1807	2115	95		5.4						
		solo per cartongesso - for plasterboard only - solo para cartòn	24,3	700	4000	2376	2800	95	15°	5.4	ø90	165	0,80	LTN20.940S	01 02 49
			17	500	4000	1901	2115	95		7.3					
			24,3	700	4000	2475	2800	95		5.4					
A+	17	500	4000	1901	2115	95	24°	5.4	ø90	165	0,80	LTN20.940F	01 02 49		
	24,3	700	4000	2376	2800	95		7.3							
	17	500	4000	1901	2115	95		5.4							
A+	24,3	700	4000	2475	2800	95	38°	5.4	ø90	165	0,80	LTN20.940W	01 02 49		
	17	500	4000	1901	2115	95		7.3							
	24,3	700	4000	2475	2800	95		5.4							

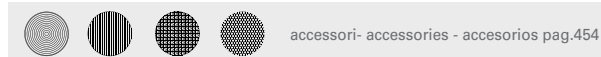
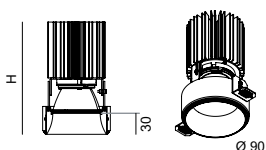

## NYX T111F

FIXED FIJO



	W	mA	K	lm product	lm/Led	CRI	∠	A	Dim.	H	Kg	CODE	Col.		
	24,3	700	3000	2045	2545	95	16°	7.3	ø120	180	1,43	LTN70.930S	01 02 49		
	37,5	1050	3000	2731	3785	95		10.1							
	24,3	700	3000	2160	2545	95		7.3							
	3SDCM 50000h L90 B10 ta 25°C	37,5	1050	3000	2886	3785	95	25°	10.1	ø120	180	1,43	LTN70.930F	01 02 49	
		24,3	700	3000	2250	2545	95		7.3						
		37,5	1050	3000	3020	3785	95		10.1						
	A+	24,3	700	4000	2250	2800	95	40°	7.3	ø120	180	1,43	LTN70.930W	01 02 49	
		37,5	1050	4000	2998	4155	95		10.1						
		24,3	700	4000	2250	2800	95		7.3						
		solo per cartongesso - for plasterboard only - solo para cartòn	37,5	1050	4000	2998	4155	95	16°	7.3	ø120	180	1,43	LTN70.940S	01 02 49
			24,3	700	4000	2376	2800	95		10.1					
			37,5	1050	4000	3168	4155	95		7.3					
A+	24,3	700	4000	2475	2800	95	25°	10.1	ø120	180	1,43	LTN70.940F	01 02 49		
	37,5	1050	4000	3168	4155	95		7.3							
	24,3	700	4000	2475	2800	95		10.1							
A+	37,5	1050	4000	3315	4155	95	40°	10.1	ø120	180	1,43	LTN70.940W	01 02 49		
	24,3	700	4000	2475	2800	95		7.3							
	37,5	1050	4000	3315	4155	95		10.1							

	W				A	Dim.	H	Kg	CODE	Col.
QR-LP 111 G53 12V	1X LED /Halo max 60	per cartongesso/for plasterboard/para cartòn		A+-D	T.2	ø120	70	0,50	LTN76	01 02 49
	1X LED /Halo max 60	per laterizio/for brick wall/para ladrillo			T.2	205x170	140	0,90	LTN77	01 02 49

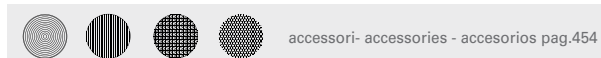
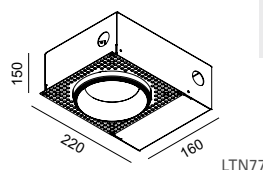
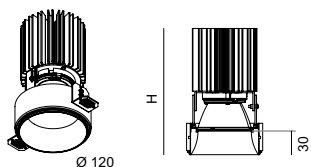

01 - bianco - white - blanco    02 - nero - black - negro    49 - moka

pag.824    pag.820

# NYX T80D

DIRECTIONAL - AJUSTABLE



LED

W	mA	K	Im product	Im/Led	CRI	∠
17	500	3000	1546	1925	95	15°
24,3	700	3000	2045	2545	95	
17	500	3000	1645	1925	95	24°
24,3	700	3000	2160	2545	95	
17	500	3000	1730	1925	95	38°
24,3	700	3000	2250	2545	95	
17	500	4000	1699	2115	95	15°
24,3	700	4000	2250	2800	95	
17	500	4000	1807	2115	95	24°
24,3	700	4000	2376	2800	95	
17	500	4000	1901	2115	95	38°
24,3	700	4000	2475	2800	95	



A	Dim.	H	α	Kg	CODE	Col.
5.4	ø105	155	20	1,00	LTN25.930S	01 02 49
7.3						
5.4	ø105	155	20	1,00	LTN25.930F	01 02 49
7.3						
5.4	ø105	155	20	1,00	LTN25.930W	01 02 49
7.3						
5.4	ø105	155	20	1,00	LTN25.940S	01 02 49
7.3						
5.4	ø105	155	20	1,00	LTN25.940F	01 02 49
7.3						
5.4	ø105	155	20	1,00	LTN25.940W	01 02 49
7.3						

3SDCM  
50000h L90  
B10 ta 25°C

A+

solo per cartongesso - for plasterboard only - solo para cartón

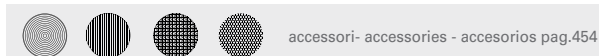
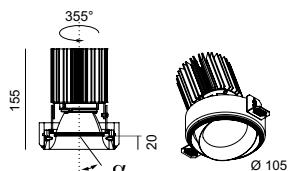

DOWNLIGHTERS

# NYX T111D

DIRECTIONAL - AJUSTABLE



LED

W	mA	K	Im product	Im/Led	CRI	∠
24,3	700	3000	2045	2545	95	16°
37,5	1050	3000	2731	3785	95	
24,3	700	3000	2160	2545	95	25°
37,5	1050	3000	2886	3785	95	
24,3	700	3000	2250	2545	95	40°
37,5	1050	3000	3020	3785	95	
24,3	700	4000	2250	2800	95	16°
37,5	1050	4000	2998	4155	95	
24,3	700	4000	2376	2800	95	25°
37,5	1050	4000	3168	4155	95	
24,3	700	4000	2475	2800	95	40°
37,5	1050	4000	3315	4155	95	



A	Dim.	H	α	Kg	CODE	Col.
7.3	ø130	180	20	1,20	LTN80.930S	01 02 49
10.1						
7.3	ø130	180	20	1,20	LTN80.930F	01 02 49
10.1						
7.3	ø130	180	20	1,20	LTN80.930W	01 02 49
10.1						
7.3	ø130	180	20	1,20	LTN80.940S	01 02 49
10.1						
7.3	ø130	180	20	1,20	LTN80.940F	01 02 49
10.1						
7.3	ø130	180	20	1,20	LTN80.940W	01 02 49
10.1						

3SDCM  
50000h L90  
B10 ta 25°C

A+

solo per cartongesso - for plasterboard only - solo para cartón



W	per cartongesso/for plasterboard/para cartón	A	Dim.	H	Kg	CODE	Col.
60	per cartongesso/for plasterboard/para cartón	T.2	ø130	70	1,40	LTN86	01 02 49
60	per laterizio/for brick wall/para ladrillo	T.2	205x170	140	1,40	LTN87	01 02 49

A+-D

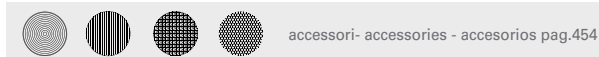
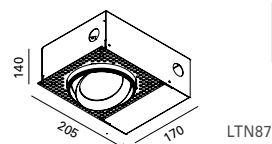
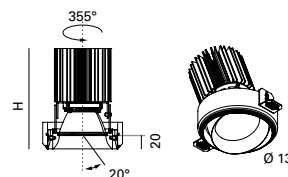

01 - bianco - white - blanco    02 - nero - black - negro    49 - moka

pag.824    A pag.820

## NYX FRAME

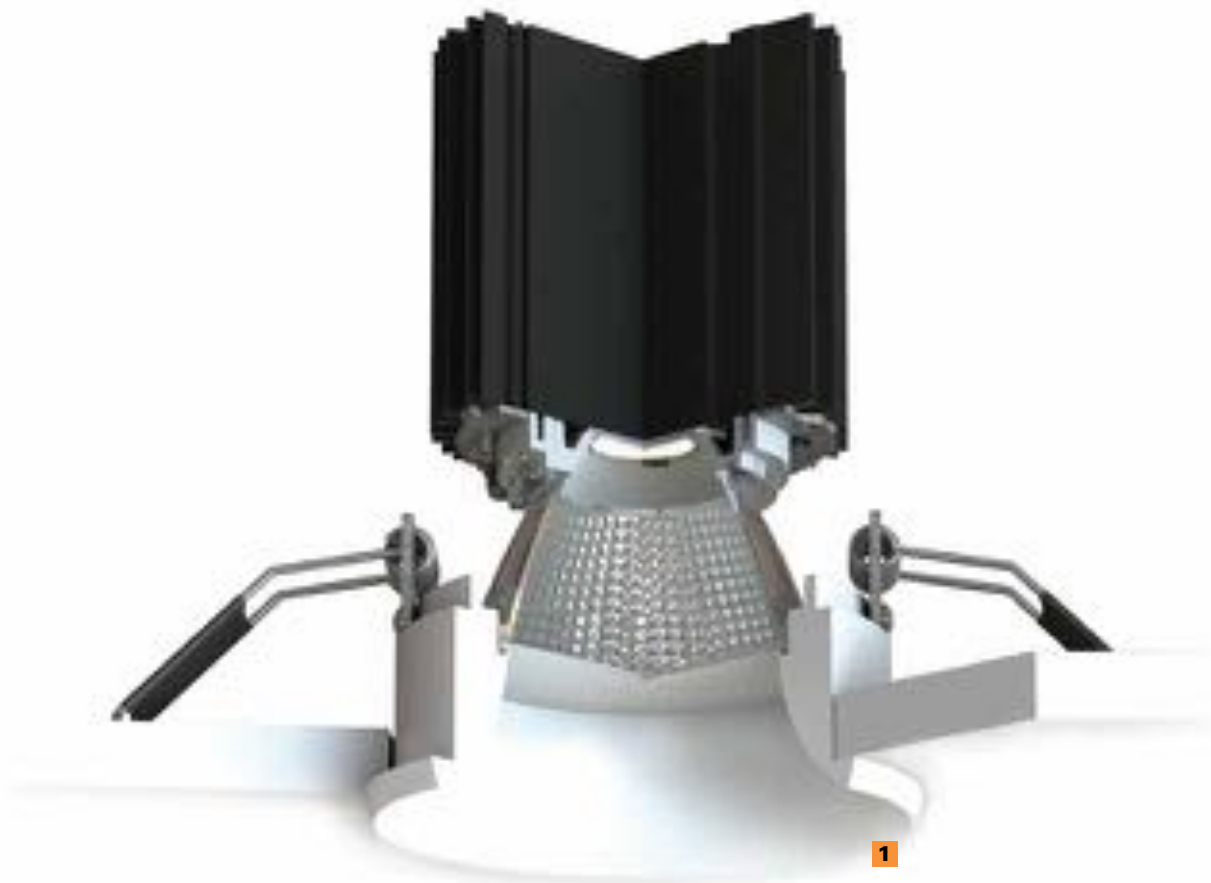

---

**2**

---

**3**

---

**4**

I Nyx Frame sono disponibili in quattro finiture colore:  
bianco, nero, oro e moka

The Nyx Frame range is available in four colour finishings:  
white, black, gold and moka.

- 
- 1** Bianco / White
  - 2** Nero / Black
  - 3** Oro / Gold
  - 4** Moka





## NYX FRAME TF35F

FIXED FIJO



	W	mA	K	lm product	lm/Led	CRI	∠	A	Dim.	H	Kg	CODE	Col.	
LED	5	500	3000	310	395	95	22°	5.1	ø60	80	0,18	NF010.930F	01 02 36 49	CE IP20 IP54 LED A+
50000h L90 B10 ta 25°C	solo per cartongesso - for plasterboard only - solo para cartòn													
OR-CB35 GU4 12V	1 x max 35							T.1	ø60	70	0,16	NF014	01 02 36 49	CE IP20 IP54 LED A+ 12V 3C
A <sup>+</sup> D	solo per cartongesso - for plasterboard only - solo para cartòn													

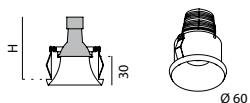

## NYX FRAME TF50F

FIXED FIJO



	W	mA	K	lm product	lm/Led	CRI	∠	A	Dim.	H	Kg	CODE	Col.	
LED	6,8	350	3000	330	494	>90	24°	3.1	ø75	100	0,25	NF020.930F	01 02 36 49	
	6,8	350	3000	450	494	>90	36°	3.1	ø75	100	0,25	NF020.930W	01 02 36 49	
	6,8	350	4000	363	544	>90	24°	3.1	ø75	100	0,25	NF020.940F	01 02 36 49	
	6,8	350	4000	496	544	>90	36°	3.1	ø75	100	0,25	NF020.940W	01 02 36 49	
3SDCM 50000h L90 B10 ta 25°C	11	350	2700	931	1100	>90	29°	3.2	ø75	120	0,25	NF022.927S	01 02 36 49	CE IP20 IP54 LED A+
	11	350	2700	703	1100	>90	42°	3.2	ø75	120	0,25	NF022.927F	01 02 36 49	
	11	350	3000	1003	1185	>90	29°	3.2	ø75	120	0,25	NF022.930S	01 02 36 49	
	11	350	3000	757	1185	>90	42°	3.2	ø75	120	0,25	NF022.930F	01 02 36 49	
	11	350	4000	1088	1285	>90	29°	3.2	ø75	120	0,25	NF022.940S	01 02 36 49	
	11	350	4000	821	1285	>90	42°	3.2	ø75	120	0,25	NF022.940F	01 02 36 49	
OR-CB51 GU5,3 12V	1 x max 50							T.1	ø75	80	0,23	NF027	01 02 36 49	CE IP20 IP54 LED A+
A <sup>+</sup> D	solo per cartongesso - for plasterboard only - solo para cartòn													
QPAR16 GU10 230V	1 x max 50								ø75	90	0,25	NF028	01 02 36 49	CE IP20 IP54 LED A+
A <sup>+</sup> D	solo per cartongesso - for plasterboard only - solo para cartòn													

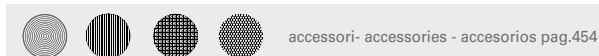
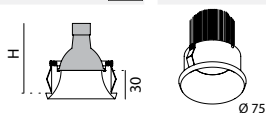

01 - bianco - white - blanco    02 - nero - black - negro    36 - oro - gold - oro    49 - moka

pag.824 **A** pag.820



# NYX FRAME TF35D

DIRECTIONAL - AJUSTABLE



LED	W	mA	K	lm product	lm/Led	CRI	α	A	Dim.	H	α	Kg	CODE	Col.	
50000h L90 B10 ta 25°C <b>A+</b>	5	500	3000	310	395	95	22°	5.1	ø75	110	20	0,28	NF015.930F	01 02 36 49	
solo per cartongesso - for plasterboard only - solo para cartòn															
QR-CB35 GU4 12V	W							A	Dim.	H	α	Kg	CODE	Col.	
<b>A+-D</b>	1 x max35							1.1	ø75	110	20	0,26	NF019	01 02 36 49	
solo per cartongesso - for plasterboard only - solo para cartòn															

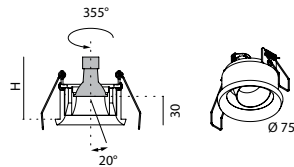

# NYX FRAME TF50D

DIRECTIONAL - AJUSTABLE



LED	W	mA	K	lm product	lm/Led	CRI	α	A	Dim.	H	α	Kg	CODE	Col.			
3SDCM 50000h L90 B10 ta 25°C <b>A+</b>	6,8	350	3000	330	494	>90	24°	3.1	ø90	100	20	0,35	NF030.930F	01 02 36 49			
	6,8	350	3000	450	494	>90	36°	3.1	ø90	100	20	0,35	NF030.930W	01 02 36 49			
	6,8	350	4000	363	544	>90	24°	3.1	ø90	100	20	0,35	NF030.940F	01 02 36 49			
	6,8	350	4000	496	544	>90	36°	3.1	ø90	100	20	0,35	NF030.940W	01 02 36 49			
LED <b>A+</b>	11	350	2700	931	1100	>90	29°	3.2	ø90	120	20	0,35	NF032.927S	01 02 36 49			
	11	350	2700	703	1100	>90	42°	3.2	ø90	120	20	0,35	NF032.927F	01 02 36 49			
	11	350	3000	1003	1185	>90	29°	3.2	ø90	120	20	0,35	NF032.930S	01 02 36 49			
	11	350	3000	757	1185	>90	42°	3.2	ø90	120	20	0,35	NF032.930F	01 02 36 49			
	11	350	4000	1088	1285	>90	29°	3.2	ø90	120	20	0,35	NF032.940S	01 02 36 49			
	11	350	4000	821	1285	>90	42°	3.2	ø90	120	20	0,35	NF032.940F	01 02 36 49			
	solo per cartongesso - for plasterboard only - solo para cartòn																
	QR-CB51 GU5,3 12V	W							A	Dim.	H	α	Kg	CODE		Col.	
<b>A+-D</b>	1 x max50							1.1	ø90	80	20	0,30	NF037	01 02 36 49			
solo per cartongesso - for plasterboard only - solo para cartòn																	
OPAR16 GU10 230V	W							Dim.	H	α	Kg	CODE	Col.				
<b>A+-D</b>	1 x max50							ø90	90	20	0,32	NF038	01 02 36 49				
solo per cartongesso - for plasterboard only - solo para cartòn																	

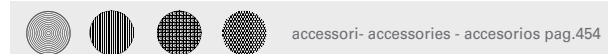
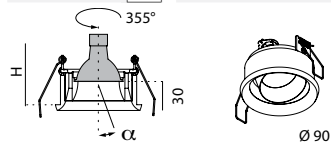

01 - bianco - white - blanco    02 - nero - black - negro    36 - oro - gold - oro    49 - moka

pag.824 **A** pag.820

## NYX FRAME TF80F

FIXED - FIJO



LED

3SDCM  
50000h L90  
B10 ta 25°C

A+

W	mA	K	Im product	Im/Led	CRI	∠
17	500	3000	1546	1925	95	15°
24,3	700	3000	2045	2545	95	15°
17	500	3000	1645	1925	95	24°
24,3	700	3000	2160	2545	95	24°
17	500	3000	1730	1925	95	38°
24,3	700	3000	2250	2545	95	38°
17	500	4000	1699	2115	95	15°
24,3	700	4000	2250	2800	95	15°
17	500	4000	1807	2115	95	24°
24,3	700	4000	2376	2800	95	24°
17	500	4000	1901	2115	95	38°
24,3	700	4000	2475	2800	95	38°

solo per cartongesso - for plasterboard only - solo para cartón



A	Dim.	H	Kg	CODE	Col.
5.4	ø110	160	0,85	NF040.930S	01 02 36 49
7.3	ø110	160	0,85	NF040.930F	01 02 36 49
5.4	ø110	160	0,85	NF040.930W	01 02 36 49
7.3	ø110	160	0,85	NF040.940S	01 02 36 49
5.4	ø110	160	0,85	NF040.940F	01 02 36 49
7.3	ø110	160	0,85	NF040.940W	01 02 36 49

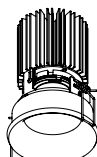
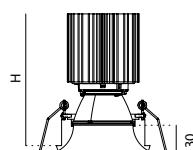

ø 110



accessori - accessories - accesorios pag.454

## NYX FRAME TF111F

FIXED - FIJO



LED

3SDCM  
50000h L90  
B10 ta 25°C

A+

W	mA	K	Im product	Im/Led	CRI	∠
24,3	700	3000	2045	2545	95	16°
37,5	1050	3000	2731	3785	95	16°
24,3	700	3000	2160	2545	95	25°
37,5	1050	3000	2886	3785	95	25°
24,3	700	3000	2250	2545	95	40°
37,5	1050	3000	3020	3785	95	40°
24,3	700	4000	2250	2800	95	16°
37,5	1050	4000	2998	4155	95	16°
24,3	700	4000	2376	2800	95	25°
37,5	1050	4000	3168	4155	95	25°
24,3	700	4000	2475	2800	95	40°
37,5	1050	4000	3315	4155	95	40°

solo per cartongesso - for plasterboard only - solo para cartón



A	Dim.	H	Kg	CODE	Col.
7.3	ø140	205	1,4	NF060.930S	01 02 36 49
10.1	ø140	205	1,4	NF060.930F	01 02 36 49
7.3	ø140	205	1,4	NF060.930W	01 02 36 49
10.1	ø140	205	1,4	NF060.940S	01 02 36 49
7.3	ø140	205	1,4	NF060.940F	01 02 36 49
10.1	ø140	205	1,4	NF060.940W	01 02 36 49

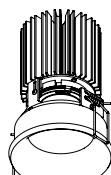
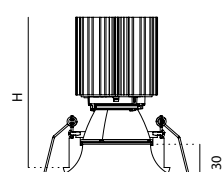

ø 140



accessori - accessories - accesorios pag.454

01 - bianco - white - blanco    02 - nero - black - negro    36 - oro - gold - oro    49 - moka

# NYX FRAME TF80D

DIRECTIONAL - AJUSTABLE



LED	W	mA	K	lm product	lm/Led	CRI	∠
	17	500	3000	1546	1925	95	15°
	24,3	700	3000	2045	2545	95	
	17	500	3000	1645	1925	95	24°
	24,3	700	3000	2160	2545	95	
	17	500	3000	1730	1925	95	38°
	24,3	700	3000	2250	2545	95	
	17	500	4000	1699	2115	95	15°
	24,3	700	4000	2250	2800	95	
	17	500	4000	1807	2115	95	24°
	24,3	700	4000	2376	2800	95	
	17	500	4000	1901	2115	95	38°
	24,3	700	4000	2475	2800	95	

3SDCM  
50000h L90  
B10 ta 25°C

**A+**

solo per cartongesso - for plasterboard only - solo para cartòn

A	Dim.	H	α	Kg	CODE	Col.
5.4	Ø130	160	20	1	NF050.930S	01 02 36 49
7.3						
5.4	Ø130	160	20	1	NF050.930F	01 02 36 49
7.3						
5.4	Ø130	160	20	1	NF050.930W	01 02 36 49
7.3						
5.4	Ø130	160	20	1	NF050.940S	01 02 36 49
7.3						
5.4	Ø130	160	20	1	NF050.940F	01 02 36 49
7.3						
5.4	Ø130	160	20	1	NF050.940W	01 02 36 49
7.3						

CE IP20  
LED  
accessori- accessories - accesorios pag.454

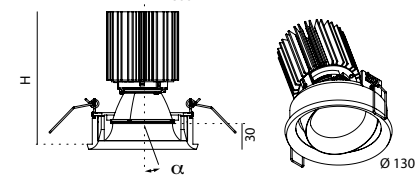

# NYX FRAME TF111D

DIRECTIONAL - AJUSTABLE



LED	W	mA	K	lm product	lm/Led	CRI	∠
	24,3	700	3000	2045	2545	95	16°
	37,5	1050	3000	2731	3785	95	
	24,3	700	3000	2160	2545	95	25°
	37,5	1050	3000	2886	3785	95	
	24,3	700	3000	2250	2545	95	40°
	37,5	1050	3000	3020	3785	95	
	24,3	700	4000	2250	2800	95	16°
	37,5	1050	4000	2998	4155	95	
	24,3	700	4000	2376	2800	95	25°
	37,5	1050	4000	3168	4155	95	
	24,3	700	4000	2475	2800	95	40°
	37,5	1050	4000	3315	4155	95	

3SDCM  
50000h L90  
B10 ta 25°C

**A+**

solo per cartongesso - for plasterboard only - solo para cartòn

A	Dim.	H	α	Kg	CODE	Col.
7.3	Ø160	205	20	1,65	NF070.930S	01 02 36 49
10.1						
7.3	Ø160	205	20	1,65	NF070.930F	01 02 36 49
10.1						
7.3	Ø160	205	20	1,65	NF070.930W	01 02 36 49
10.1						
7.3	Ø160	205	20	1,65	NF070.940S	01 02 36 49
10.1						
7.3	Ø160	205	20	1,65	NF070.940F	01 02 36 49
10.1						
7.3	Ø160	205	20	1,65	NF070.940W	01 02 36 49
10.1						

CE IP20  
LED  
accessori- accessories - accesorios pag.454

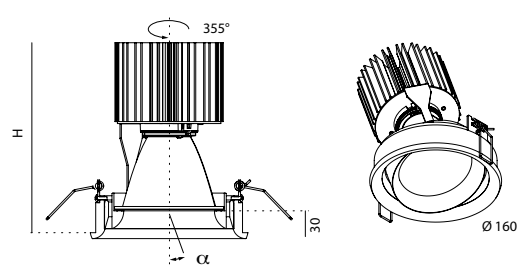

01 - bianco - white - blanco    02 - nero - black - negro    36 - oro - gold - oro    49 - moka

pag.824 **A** pag.820

DOWNLIGHTERS

## NYX DIFFUSED

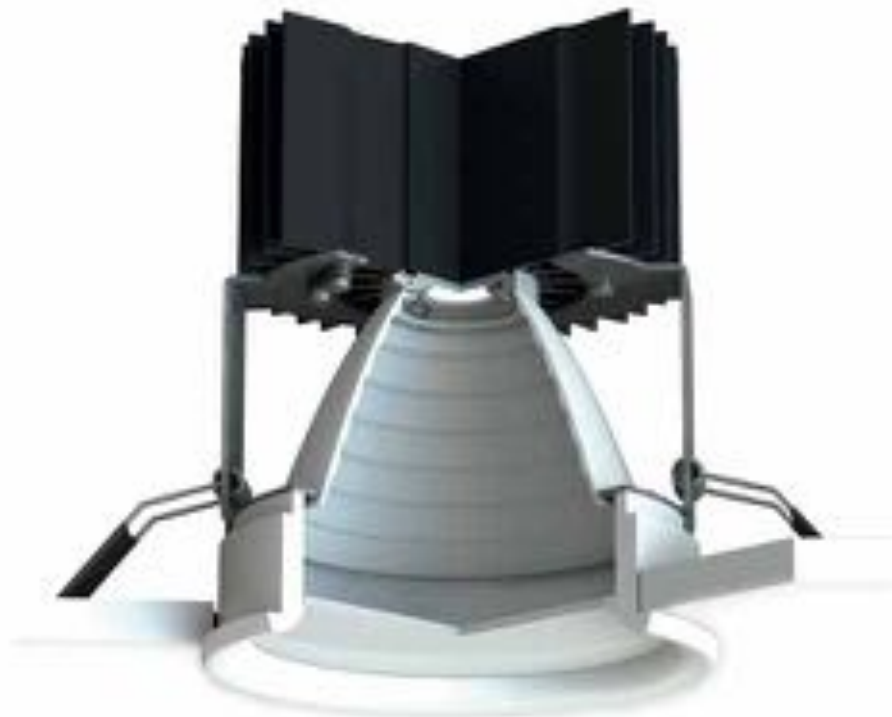

Apparecchio da incasso a soffitto con cornice di battuta, per illuminazione diretta e diffusa. Completo di diffusore opalino o microprismatico. Sorgente LED Chip On Board integrata. Nella versione led integrato riflettore metallizzato in alluminio puro 99,9%. Corpo e gruppo ottico in alluminio verniciato. Alimentazione remota disponibile come accessorio. Grado di protezione IP43.

Recessed downlight for false-ceiling installation, for diffused lighting. Complete with polycarbonate opal or low luminance microprismatic diffuser. Integrated Chip On Board LED source. Body and optical group in painted aluminum. 99,99% pure aluminum coated reflector. Remote power-supply degree of protection IP43.

Aparato para empotrar en el techo con marco de tope, para iluminación directa y difusa. Con difusor opalino o microprismático. Fuente LED Chip On Board integrada. En la versión led integrado, reflector metalizado de aluminio puro 99,9%. Cuerpo y grupo óptico de aluminio pintado. Alimentación remota disponible como accesorio. Grado de protección IP43.

## NYX DIFFUSED 160 OPAL

FIXED WITH OPAL DIFFUSER - FIJO CON DIFUSOR OPALINO



LED

3SDCM  
50000h L90  
B10 ta 25°C

A+

W	mA	K	lm product	lm/Led	CRI	∠
17	500	3000	1553	1925	95	40°
24,3	700	3000	2169	2545	95	
17	500	4000	1706	2115	95	40°
24,3	700	4000	2386	2800	95	

SOLO PER CARTONGESSO - FOR PLASTERBOARD ONLY - SOLO PARA CARTÓN

A	Dim.	H	Kg
5.4	ø160	200	1.7
7.3	ø160	200	1.7
5.4	ø160	200	1.7
7.3	ø160	200	1.7

CODE	Col.
NFD00.930W 01 02 36 49	
NFD00.940W 01 02 36 49	

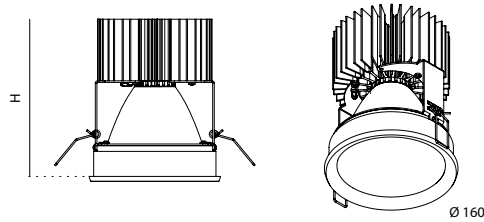

## NYX DIFFUSED 160 MICROPRISMATIC

FIXED WITH MICROPRISMATIC DIFFUSER - FIJO CON DIFUSOR MICROPRISMATICO



LED

3SDCM  
50000h L90  
B10 ta 25°C

A+

W	mA	K	lm product	lm/Led	CRI	∠
17	500	3000	1550	1925	95	40°
24,3	700	3000	2169	2545	95	
17	500	4000	1703	2115	95	40°
24,3	700	4000	2386	2800	95	

solo per cartongesso - for plasterboard only - solo para cartón

A	Dim.	H	Kg
5.4	ø160	200	1.7
7.3	ø160	200	1.7
5.4	ø160	200	1.7
7.3	ø160	200	1.7

CODE	Col.
NFD00X.930W 01 02 36 49	
NFD00X.940W 01 02 36 49	

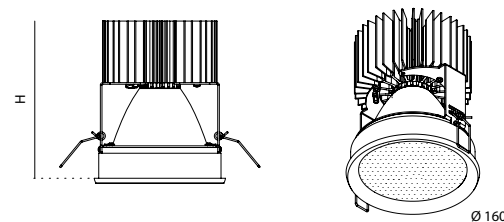

01 - bianco - white - blanco    02 - nero - black - negro    36 - oro - gold - oro    49 - moka

pag.824    A pag.820











Apparecchio da incasso in controsoffitto in cartongesso, rasato a scomparsa totale, trimless, per illuminazione d'accento. Sorgente luminosa in posizione arretrata antiabbagliamento UGR<19. Provvisto di cilindro estraibile dalla sede di incasso fino a 6 o 10 cm., a seconda del modello, per trasformarlo in semincasso (operazione effettuabile ad installazione avvenuta e senza l'ausilio di attrezzi). Con sorgente LED Chip On Board integrata o per lampade alogene/led QR-CB 35, QR-CB 51 12V/230V, QPAR16 230V/240V. Nella versione led integrato riflettore metallizzato in alluminio puro 99,9%. Corpo e gruppo ottico in alluminio verniciato. Alimentazione remota disponibile come accessorio. Grado di protezione IP54.

Trimless recessed downlighter for plasterboard ceiling installation, for accent lighting. Light source in recessed position for anti-glare lighting (UGR<19). For integrated Chip On Board LED source or for 12V/230V QR-CB 35, QR-CB 51 or 230V QPAR16 GU10 halogen/led lamps. Provided with extractable cylinder up to 6-10 cm., according to the model, to transform the recessed fitting into a semi-recessed one (this operation can be done once the downlighter is installed, tools-free). Body and optical group in painted aluminum. Version with Integrated Chip On Board LED source provided with 99,99% pure aluminum coated reflector. Remote power-supply available as an accessory. Degree of protection IP54.

Aparato para empotrar en falso techo de placa de yeso, al ras totalmente empotrable, "trimless", para iluminación de realce. Fuente luminosa con posición retrasada antideslumbramiento UGR<19. Dispone de cilindro extraíble de la sede de empotrar de hasta 6 o 10 cm, dependiendo del modelo, para transformarlo en semiempotrable (operación posible después de la instalación y sin ayuda de herramientas). Con fuente LED Chip On Board integrada o para lámparas halógenas/led QR-CB 35, QR-CB 51 12V/230V, QPAR16 230V/240V. En la versión led integrado reflector metalizado de aluminio puro 99,9%. Cuerpo y grupo óptico de aluminio pintado. Alimentación remota disponible como accesorio. Grado de protección IP54.



## INCASSO O SEMINCASSO?

NYXTUBE è provvisto di un cilindro estraibile che permette di trasformarlo da incasso trimless con sorgente luminosa in posizione molto arretrata e quindi antiabbagliamento a semincasso UGR<19. Il cilindro può essere estratto dalla sede di incasso fino a 6 o 10 cm., a seconda dei modelli. L'estrazione viene effettuata dopo aver installato il corpo dell'apparecchio nel controsoffitto e senza l'ausilio di attrezzi. E' quindi possibile variare l'altezza del cilindro anche nel tempo e creare, all'interno di una installazione, giochi di altezze diverse.

## RECESSED OR SEMI-RECESSED?

NYXTUBE is provided with an extractable cylinder that allows to transform it from a trimless recessed to a semi-recessed downlighter. The light source, in both configurations, always remains very recessed, thus guaranteeing a low luminance (UGR<19) light emission. The cylinder can be extracted from the ceiling up to 6 or 10 cm., according to the models. The extraction is done once the downlighter is installed, with the simple use of hands, tool-free. It is possible, therefore, to vary the height of the cylinder later on, creating specific scenarios within an environment by setting the cylinders at different heights.

## ¿EMPOTRABLE O SEMIEMPOTRABLE?

NYXTUBE tiene un cilindro extraíble que permite transformarlo de empotrable "trimless" con fuente luminosa en posición muy retrasada y, por lo tanto, antideslumbramiento, semiempotrable UGR<19. El cilindro se puede sacar de la sede de empotre de hasta 6 o 10 cm, dependiendo de los modelos. La extracción se lleva a cabo después de instalar el cuerpo del aparato en el falso techo y sin ayuda de herramientas. Por lo tanto, es posible cambiar la altura del cilindro en diferentes momentos y crear, dentro de una instalación, juegos de alturas diferentes.

## NYX TUBE



## NYX TUBE 35

FIXED EXTRACTABLE - FIJO EXTRAÍBLE



LED	W	mA	K	lm product	lm/Led	CRI	∠	A	Dim.	H	CODE	Col.	CE	IP20	IP54	LED
	5	500	3000	168	395	95	10°	5.1	ø40	70/130	LTN30T.930S	01 02 49	IP20	IP54	LED	
<b>A+</b>	per cartongesso/for plasterboard/para cartòn															

QR-CB35 GU4 12V	W	∠	A	Dim.	H	CODE	Col.	CE	IP20	IP54	LED
	1 x max 35	10°	T.1	ø40	70/130	LTN34T	01 02 49	IP20	IP54	LED	
<b>A+-D</b>	per cartongesso/for plasterboard/para cartòn										

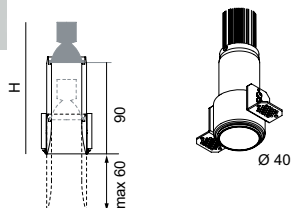

## NYX TUBE 50

FIXED EXTRACTABLE - FIJO EXTRAÍBLE



LED	W	mA	K	lm product	lm/Led	CRI	∠	A	Dim.	H	CODE	Col.	CE	IP20	IP54	LED
	6,8	350	3000	140	494	>90	16°	3.1	ø55	120/220	LTN48T.930S	01 02 49	IP20	IP54	LED	
	6,8	350	4000	154	544	>90	16°	3.1	ø55	120/220	LTN48T.940S	01 02 49	IP20	IP54	LED	
	11	350	3000	340	1065	>90	16°	3.2	ø55	120/220	LTN50T.930S	01 02 49	IP20	IP54	LED	
	11	350	4000	362	1135	>90	16°	3.2	ø55	120/220	LTN50T.940S	01 02 49	IP20	IP54	LED	
<b>A+</b>	per cartongesso/for plasterboard/para cartòn															

QR-CB51 GU5,3 12V	W	∠	A	Dim.	H	CODE	Col.	CE	IP20	IP54	LED
	1 x max 50	10°	T.1	ø55	90/190	LTN54T	01 02 49	IP20	IP54	LED	
<b>A+-D</b>	per cartongesso/for plasterboard/para cartòn										

QPAR16 GU10 230V	W	∠	Dim.	H	CODE	Col.	CE	IP20	IP54	LED
	1 x max 50	10°	ø55	100/200	LTN56T	01 02 49	IP20	IP54	LED	
<b>A+-D</b>	per cartongesso/for plasterboard/para cartòn									

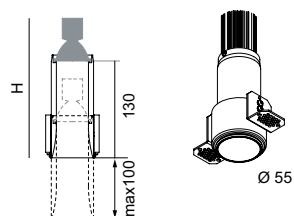

01 - bianco - white - blanco 02 - nero - black - negro 49 - moka



A pag.820

## LENTE

LENS - LENTE

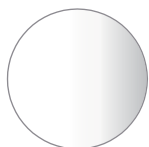

LENTE SATINATA / SATIN LENS / LENTE SATINADA

NYX	T80F	T80D	TF80F	TF80D
	T111F	T111D	TF111F	TF111D

Dim.  
Ø 74  
Ø 111

CODE  
L074S  
L111S



Adatto solo per sorgenti led / Suitable for LED sources

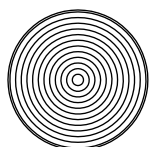

LENTE FRESNEL / FRESNEL LENS / LENTE FRESNEL

NYX	Q50	T50F	T50D	TF50F	TF50D
	T80F	T80D	TF80F	TF80D	
	T111F	T111D	TF111F	TF111D	

Dim.  
Ø 50  
Ø 74  
Ø 111

CODE  
L050F  
L074F  
L111F



Adatto solo per sorgenti LED / Suitable for LED sources

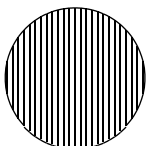

LENTE ELISSOIDALE / ELIPSOID LENS / LENTE ELIPSOIDAL

NYX	Q50	T50F	T50D	TF50F	TF50D
	T80F	T80D	TF80F	TF80D	
	T111F	T111D	TF111F	TF111D	

Dim.  
Ø 50  
Ø 74  
Ø 111

CODE  
L050E  
L074E  
L111E



Adatto solo per sorgenti LED / Suitable for LED sources

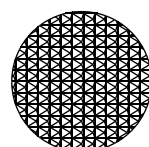

LENTE ASIMMETRICA / ASYMMETRIC LENS / LENTE ASIMÉTRICA

NYX	Q50	T50F	T50D	TF50F	TF50D
	T80F	T80D	TF80F	TF80D	
	T111F	T111D	TF111F	TF111D	

Dim.  
Ø 50  
Ø 74  
Ø 111

CODE  
L050A  
L074A  
L111A



Adatto solo per sorgenti LED / Suitable for LED sources

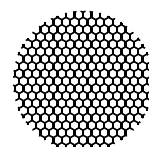

FILTRO NIDO D'APE / HONEY COMB LOUVER / REJILLA DE NIDO DE ABEJA

NYX	Q50	T50F	T50D	TF50F	TF50D
	T80F	T80D	TF80F	TF80D	
	T111F	T111D	TF111F	TF111D	

Dim.  
Ø 50  
Ø 74  
Ø 111

CODE  
L050R  
L074R  
L111R



Adatto a tutti i tipi di sorgenti / Suitable for all sources / Adecuado para todos los tipos de fuentes

Con l'utilizzo di questa lente varia il grado di protezione del prodotto da IP54 a IP20 / The use of this lens varies the degree of protection from IP54 to IP20 / Con el uso de esta lente cambia el grado de protección del producto de IP54 a IP20.



DULCIS IMOLA - ITALY  
PROJECT STUDIO ATAINOVE  
LIGHTING FORMAT DESIGN STUDIO  
PHOTO A.LIVERANI

Programma di incassi e proiettori da incasso a soffitto per sorgenti LED Chip On Board integrate. Studiato per ottenere, mediante la semplice aggiunta di accessori al corpo lampada, 27 diverse soluzioni illuminotecniche, come varianti delle seguenti emissioni base: diffusa, spot, bassa luminanza e asimmetrica. Disponibili sia in versione rasata, a scomparsa totale, di forma tonda, sia con cornice di battuta di forma tonda o quadrata. Versioni a incasso "puro" disponibili sia con sorgente fissa che orientabile di 355° sull'asse verticale e 30° sull'asse orizzontale. Versioni a incasso con proiettore disponibili con sorgente orientabile di 355° sull'asse verticale e 35° sull'asse orizzontale o estraibile ed orientabile di 355° sull'asse verticale e 50° sull'asse orizzontale, provviste di meccanismo roto-traslante. Corpo lampada da incassare a soffitto e gruppo ottico in alluminio verniciato. Riflettore metallizzato in alluminio purissimo 99,99%. Cover coniche in alluminio, per ottenere emissione bassa luminanza, diffusa o asimmetrica, provviste di sistema Click and Play di fissaggio e sgancio con il gruppo ottico, mediante calamite tubolari. Lenti trasparente, satinata, Fresnel e microprismatica (UGR<19) in policarbonato. Griglia a nido d'ape antiabbagliamento in alluminio verniciato. Cover di chiusura inferiori in alluminio verniciato, con foro ellittico, quadrato e tondo, per nascondere la presenza dell'apparecchio. Grado di protezione IP23/43.

Recessed downlighters and spotlights programme for chip on board LED sources. Conceived to get, by the insertion of accessories into the fixture body, 27 different lighting effects, as variations of the following three basic lighting emissions: spot, diffused, low luminance and asymmetrical. Available in round trimless version and in square or round frame version. Recessed downlighter available with fix or with 355° vertically and +/-30° horizontally adjustable optical group. Recessed directional spotlight's optical group adjustable 355° vertically and +/-35° horizontally. Recessed directional and extractable spotlight's optical group adjustable 355° vertically and +/-50° horizontally, provided with patented Soft Rotate & Slide mechanism. Fixture body and optical group in painted aluminum. Reflector coated with 99,99% pure aluminum. Conic-shaped aluminum covers, to get accent, diffused, low luminance and asymmetrical lighting emission, provided with Click&Play magnetic lock-unlock system to optical group. Fresnel, transparent, satin and microprismatic lenses in polycarbonate, honeycomb grid in painted aluminum. Lower closure flat covers in painted aluminum, provided with elliptical, square or round hole to hide from view the lighting fixture. Degree of protection IP23/43.

Programa de empotrables y proyectores para empotrar al techo para fuentes LED Chip On Board integradas. Diseñado para lograr, mediante la simple adición de accesorios al cuerpo de la lámpara, 27 diferentes soluciones de iluminación, como variación de las siguientes emisiones bajas: difusa, spot, baja luminancia y asimétrica. Disponible a ras, totalmente empotrable, de forma redonda y versión con marco de tope de forma redonda o cuadrada. Versión para empotrar con proyector disponible con fuente orientable de 355° en el eje vertical y 30° en el eje horizontal. Versiones para empotrar "puro" con fuente orientable de 355° en el eje vertical y 30° en el eje horizontal o disponible con fuente extraíble y orientable de 355° en el eje vertical y 50° en el eje horizontal, equipadas con mecanismo rototraslante. Cuerpo de la lámpara para empotrar en el techo y grupo óptico de aluminio pintado. Reflector metalizado de aluminio puro 99,99%. Cubiertas cónicas de aluminio, para obtener emisiones de baja luminancia, difusa o asimétrica, equipadas con sistema Click and Play de fijación y desenganche del grupo óptico, por medio de imanes tubulares. Lente transparente, satinada, Fresnel y microprismática (UGR<19) de policarbonato. Rejilla de panel antideslumbramiento de aluminio pintado. Cubiertas de cierre inferiores de aluminio pintado, con orificio elíptico, cuadrado y redondo, para ocultar la presencia del aparato. Grado de protección IP23/43.



**TWENTY 7**









# TWENTY 7 RANGE

**1**

**ANELLO  
RING/  
ANILLO**



Minimal/ Minimal

**2**

**GRUPPO OTTICO /  
OPTIC GROUP/  
GRUPO ÓPTICO**



LED  
Fisso/ Fixed/Fijo



LED  
Orientabile /  
Directional/ Orientable

**3**

**RIFLETTORE/  
RIFLECTOR/  
REFLECTORE**



**4**

**COVER  
COVER/  
CUBIERTA**





## TWENTY 7 RE-FITTING

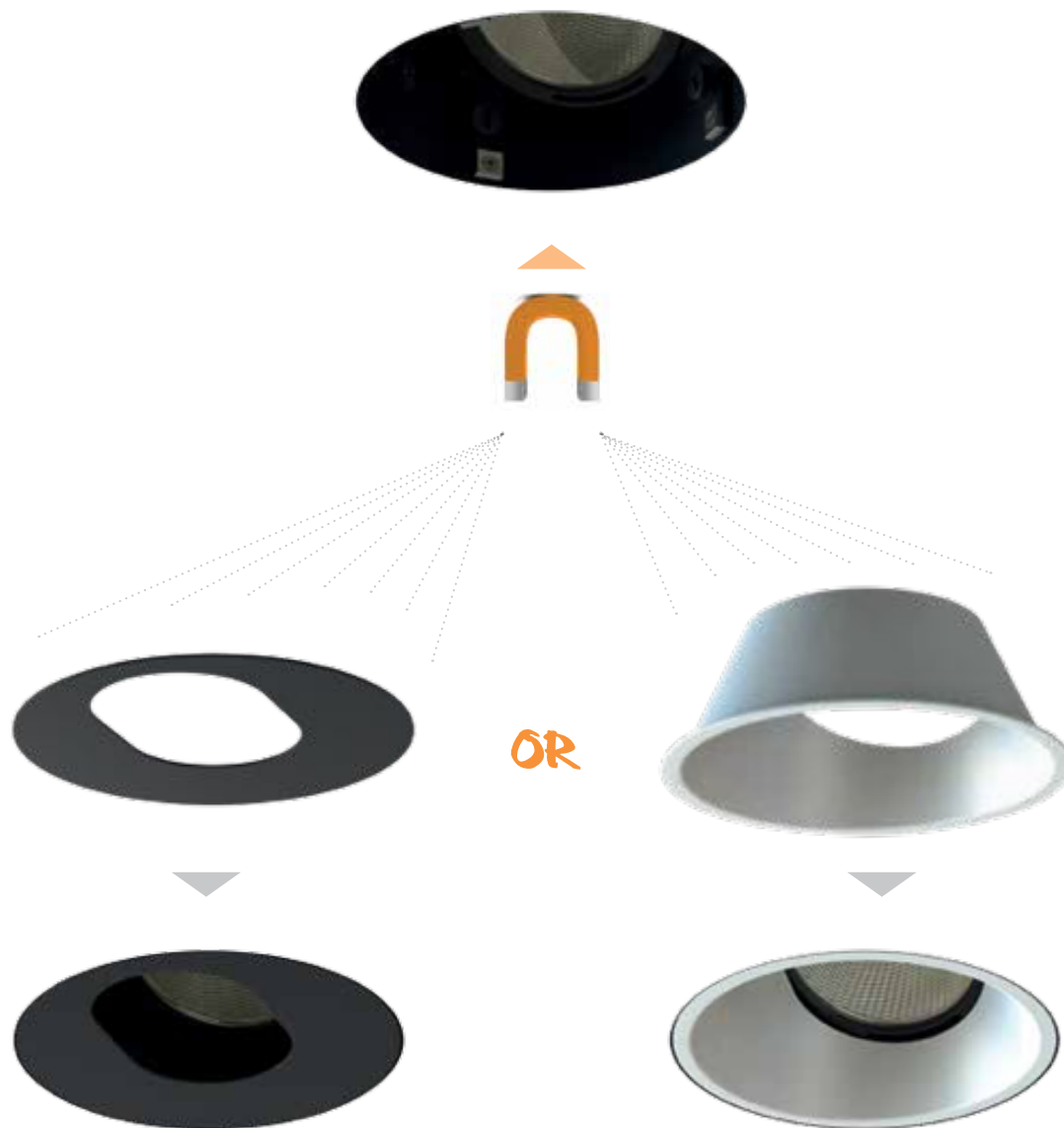

Twenty7 è provvisto di sistema Click&Play di fissaggio e sgancio delle cover al gruppo ottico mediante calamite.

Twenty7 is provided with Click&Play magnetic lock-unlock system of the cover to optical group.

Twenty7 está provisto de sistema Click&Play de fijación y desenganche de las cubiertas del grupo óptico por medio de imanes.





## TWENTY 7



## STEP 1 TELAIO MINIMAL

MINIMAL RING- MARCO MINIMALE



STEP 1

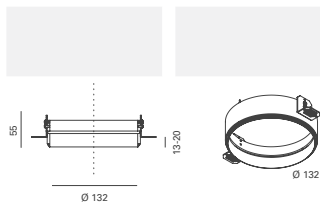

Dim.	H	Kg	CODE
Ø 132	55	0,17	TW001



## STEP 2 GRUPPO OTTICO ORIENTABILE

DIRECTIONAL OPTIC GROUP- GRUPO ÓPTICO DIRECCIONAL

STEP 2



LED

3SDCM  
50000h L90  
B10 ta 25°



W	mA	K	Im product	Im/Led	CRI
17	500	2700	1790	1790	95
24,3	700	2700	2370	2370	95
17	500	3000	1925	1925	95
24,3	700	3000	2545	2545	95
17	500	4000	2115	2115	95
24,3	700	4000	2800	2800	95
37,5	1050	2700	3530	3530	95
37,5	1050	3000	3785	3785	95
37,5	1050	4000	4155	4155	95

A	Dim.	H	α	Kg	CODE
5.4	Ø 131	151-172	30	0,75	TW020.927
7.3	Ø 131	151-172	30	0,75	TW020.930
5.4	Ø 131	151-172	30	0,75	TW020.930
7.3	Ø 131	151-172	30	0,75	TW020.940
5.4	Ø 131	151-172	30	0,75	TW020.940
7.3	Ø 131	151-172	30	0,75	TW021.927
10.1	Ø 131	151-172	30	0,75	TW021.930
10.1	Ø 131	151-172	30	0,75	TW021.930
10.1	Ø 131	151-172	30	0,75	TW021.940

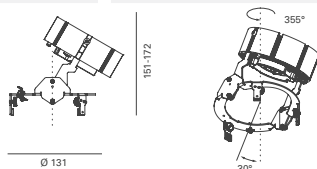

## STEP 3 RIFLETTORE

REFLECTOR- REFLECTOR

STEP 3



15°  
24°  
38°

Kg	Cod.	Col.
0,05	R085S.A	01 02
0,05	R085FA	01 02
0,05	R085W.A	01 02



accessori - accessory  
accesorios pag. 484

## STEP 4 COVER CONICA

CONIC-SHAPE COVER - CUBIERTA CÓNICA ORIFICIO ELÍPTICO

STEP 4



△	17W 3000k	24,3W 3000K	37,5W 3000K	Dim.	H	Kg	CODE.	Col
15°	1080 lm/p			Ø131	48	0,13	TW070	01 02
24°	1212 lm/p	1626 lm/p	2130 lm/p	Ø131	48	0,13		
41°	1697 lm/p	2233 lm/p	2970 lm/p	Ø131	48	0,13		

## COVER PIANA FORO ELLIPTICO

FLAT ELLIPTIC-SHAPE COVER - UBIERTA PLANA ORIFICIO ELÍPTICO

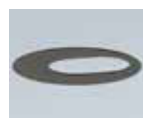

△	17W	Dim.	Kg	CODE	Col.
15°	1021 lm/p	Ø 131	0,09	TW071	01 02

da abbinare esclusivamente ad ottica 15° / only to combine with 15° optic / solo con ottica 15°

01 - bianco - white - blanco

02 - nero - black - negro

pag.824 **A** pag.820

## TWENTY 7



## STEP 1 TELAIO MINIMAL

MINIMAL RING- MARCO MINIMALE

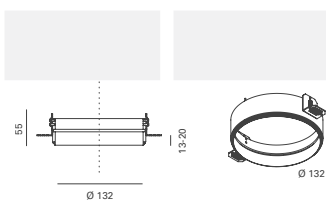

Dim.	H	Kg	CODE
Ø132	55	0,17	TW001



## STEP 2 GRUPPO OTTICO FISSO

FIX OPTIC GROUP- GRUPO OPTICO FIJO



LED

3SDCM  
50000h L90  
B10 ta 25°

A+

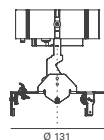

W	mA	K	lm product	lm/Led	CRI
17	500	2700	1790	1790	95
24,3	700	2700	2370	2370	95
17	500	3000	1925	1925	95
24,3	700	3000	2545	2545	95
17	500	4000	2115	2115	95
24,3	700	4000	2800	2800	95
37,5	1050	2700	3530	3530	95
37,5	1050	3000	3785	3785	95
37,5	1050	4000	4155	4155	95

A	Dim.	H	Kg	CODE
5.4	Ø131	138-160	0,75	TW025.927
7.3	Ø131	138-160	0,75	TW025.930
5.4	Ø131	138-160	0,75	TW025.930
7.3	Ø131	138-160	0,75	TW025.940
5.4	Ø131	138-160	0,75	TW025.940
7.3	Ø131	138-160	0,75	TW025.940
10.1	Ø131	138-160	0,75	TW026.927
10.1	Ø131	138-160	0,75	TW026.930
10.1	Ø131	138-160	0,75	TW026.940



## STEP 3 RIFLETTORE

REFLECTOR - REFLECTOR



W



38°

Dim.	Kg	CODE	Col.
Ø90	0,03	R090W	01 02



accessori - accessory  
accesorios pag. 484

## STEP 4 LENTE

LENS - LENTE



Diffusore satinato / Satin diffuser/difusor satinado  
Lente Asimmetrica 15° / Asymmetric Lens 15°/asimetrica 15°  
Lente Elissoidale / Elipsoid Lens/Elipsoid  
Lente Fresnel / Fresnel Lens/ Fresnel  
Filtro nido d'ape / Honey comb louver/De panel

Dim.	Kg	CODE
Ø 105	0,02	L105S
Ø 105	0,02	L105A
Ø 105	0,02	L105E
Ø 105	0,02	L105F
Ø 105	0,02	L105R

## STEP 5 COVER CONICA BASSA

SHORT CONIC SHAPED COVER - CUBIERTA CÓNICA BAJA



17W 3000K	24,3W3 3000kK	375W 3000k	∠
1415 lm/p	1854 lm/p	2410 lm/p	41°
1210 lm/p	1585 lm/p	2076 lm/p	51°

Dim.	H	Kg	CODE	Col.
Ø 131	33	0,11	TW080	01 02 03
Ø 131	33	0,11		



## TWENTY 7



## STEP 1 TELAIO MINIMAL

Ø 132 Ø 120

MINIMAL RING- MARCO MINIMALE

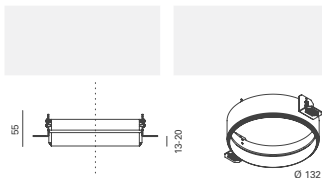

Dim.	H	Kg	CODE
Ø 132	55	0,17	TW001



## STEP 2 GRUPPO OTTICO FISSO

FIX OPTIC GROUP- GRUPO OPTICO FIJO



LED	W	mA	K	lm product	lm/Led	CRI
3SDCM 50000h L90 B10 ta 25° <b>A+</b>	17	500	2700	1790	1790	95
	24,3	700	2700	2370	2370	95
	17	500	3000	1925	1925	95
	24,3	700	3000	2545	2545	95
	17	500	4000	2115	2115	95
	24,3	700	4000	2800	2800	95
	37,5	1050	2700	3530	3530	95
	37,5	1050	3000	3785	3785	95
	37,5	1050	4000	4155	4155	95

A	Dim.	H	Kg	CODE
5.4	Ø131	138-160	0,75	TW025.927
7.3	Ø131	138-160	0,75	TW025.930
5.4	Ø131	138-160	0,75	TW025.940
7.3	Ø131	138-160	0,75	TW025.940
10.1	Ø131	138-160	0,75	TW026.927
10.1	Ø131	138-160	0,75	TW026.930
10.1	Ø131	138-160	0,75	TW026.940

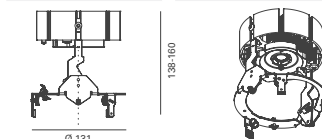

## STEP 3 RIFLETTORE

REFLECTOR- REFLECTOR



Angle	Kg	CODE	Col.
15°	0,05	R085S.A	01 02
24°	0,05	R085FA	01 02
38°	0,05	R085WA	01 02



accessori - accessory  
accessorios pag. 484

## STEP 4 COVER CONICA ALTA

CONIC-SHAPE COVER - CUBIERTA CÓNICA



W	Dim.	H	Kg	CODE	Col.
	Ø131	48	0,14	TW081	01 02 03

## COVER PIANA

FLAT-SHAPE COVER - CUBIERTA PLANA



W	Angle	Dim.	Kg	CODE	Col.
1080	15°	Ø 131	0,02	TW082	01 02
1185	21°	Ø 131	0,02	TW082	01 02



W	Angle	Dim.	Kg	CODE	Col.
1080	15°	Ø 131	0,02	TW083	01 02
1185	21°	Ø 131	0,02	TW083	01 02

## TWENTY 7





## STEP 1 TELAIO MINIMAL



MINIMAL RING- MARCO MINIMALE

STEP 1

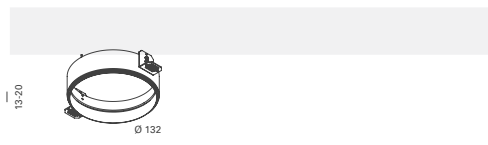
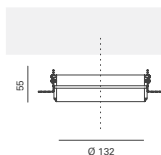

Dim.	H	Kg	CODE
Ø 132	55	0,17	TW001



## STEP 2 GRUPPO OTTICO ORIENTABILE

FOCUS DIRECTIONAL OPTIC - OPTICA ORIENTABILE FOCUS

STEP 2



LED  
3SDCM  
50000h L90  
B10 ta 25°C

A+

W	mA	K	lm product	lm/Led	CRI	∠
11	350	2700	931	1100	>90	29°
11	350	2700	703	1100	>90	42°
11	350	3000	1003	1185	>90	29°
11	350	3000	757	1185	>90	42°
11	350	4000	1088	1285	>90	29°
11	350	4000	821	1285	>90	42°

A	Dim.	H	Kg	CODE	Col.
3.2	Ø131	37+100	0,5	TW030.927S	01 02
3.2	Ø131	37+100	0,5	TW030.927F	01 02
3.2	Ø131	37+100	0,5	TW030.930S	01 02
3.2	Ø131	37+100	0,5	TW030.930F	01 02
3.2	Ø131	37+100	0,5	TW030.940S	01 02
3.2	Ø131	37+100	0,5	TW030.940F	01 02

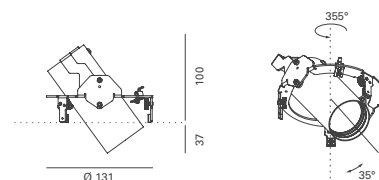

## STEP 3 COVER CONICA

CONIC-SHAPE COVER - CUBIERTA CÓNICA

STEP 3

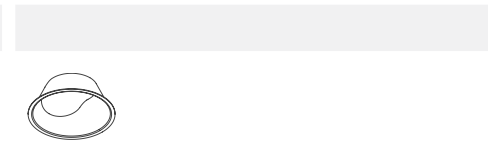
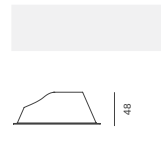

Dim.	H	Kg	CODE	Col.
Ø 131	48	0,13	TW070	01 02 03



## COVER PIANA

FLAT-SHAPE COVER - CUBIERTA PLANA

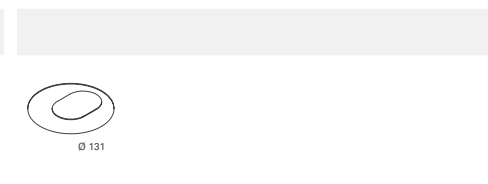
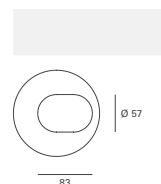

Dim.	Kg	CODE	Col.
Ø 131	0,02	TW071	01 02



01 - bianco - white - blanco 02 - nero - black - negro

pag.824

pag.820

## TWENTY 7



Gruppo ottico dotato di speciale meccanismo di estrazione roto-traslante.

Optical group provided with proprietary design Soft Rotate & Slide extraction mechanism.

Grupo óptico equipado con un mecanismo especial de extracción rototraslante.



## STEP 1 TELAIO MINIMAL

MINIMAL RING- MARCO MINIMALE

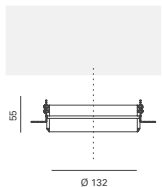

Dim.	H	Kg	CODE
Ø 132	55	0,17	TW001

CODE
TW001



## STEP 2 GRUPPO OTTICO 90 ORIENTABILE ED ESTRAIBILE

FOCUS 90 OPTIC - OPTICA FOCUS 90



LED

3SDCM  
50000h L90  
B10 ta 25°



W	mA	K	lm product	lm/Led	CRI
17	500	2700	1790	1790	95
24,3	700	2700	2370	2370	95
17	500	3000	1925	1925	95
24,3	700	3000	2545	2545	95
17	500	4000	2115	2115	95
24,3	700	4000	2800	2800	95
37,5	1050	2700	3530	3530	95
37,5	1050	3000	3785	3785	95
37,5	1050	4000	4155	4155	95

A	Dim.	H	Kg	CODE	Col.
5.4	Ø131	133+92	1,01	TW035.927	01 02
7.3	Ø131	133+92	1,01	TW035.930	01 02
5.4	Ø131	133+92	1,01	TW035.940	01 02
7.3	Ø131	133+92	1,01	TW035.940	01 02
10.1	Ø131	133+92	1,01	TW036.927	01 02
10.1	Ø131	133+92	1,01	TW036.930	01 02
10.1	Ø131	133+92	1,01	TW036.940	01 02

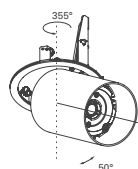
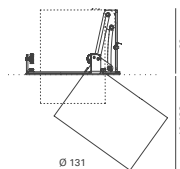

## STEP 3 RIFLETTORE

REFLECTOR- REFLECTOR



17W 3000k	24,3W 3000K
1546 lm/p	2045 lm/p
1645 lm/p	2160 lm/p
1730 lm/p	2250 lm/p



15°
24°
38°

Kg	CODE	Col.
0,05	R085S.A	01 02
0,05	R085FA	01 02
0,05	R085W.A	01 02



accessori - accessory  
acessorios pag. 484

01 - bianco - white - blanco 02 - nero - black - negro

pag.824

pag.820

## TWENTY 7



## STEP 1 TELAIIO CORNICE TONDA

ROUND FRAME RING - MARCO REDONDO



Dim.	H	Kg	CODE	Col.
Ø 132	55	0,34	TW002	01 02

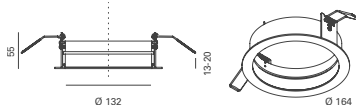

## TELAIO CORNICE QUADRA

SQUARE FRAME RING - MARCO QUADRADO



Dim.	H	Kg	CODE	Col.
Ø 132	55	0,34	TW003	01 02

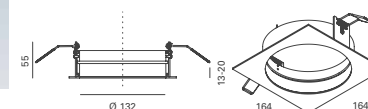

## STEP 2 GRUPPO OTTICO ORIENTABILE

DIRECTIONAL OPTIC GROUP- GRUPO ÓPTICO DIRECCIONAL



LED	W	mA	K	lm product	lm/Led	CRI
17	500	2700	1790	1790	95	
24,3	700	2700	2370	2370	95	
17	500	3000	1925	1925	95	
24,3	700	3000	2545	2545	95	
17	500	4000	2115	2115	95	
24,3	700	4000	2800	2800	95	
37,5	1050	2700	3530	3530	95	
37,5	1050	3000	3785	3785	95	
37,5	1050	4000	4155	4155	95	

3SDCM  
50000h L90  
B10 ta 25°

A+

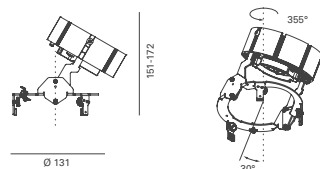

A	Dim.	H	α	Kg	CODE
5.4	Ø 131	151-172	30	0,75	TW020.927
7.3	Ø 131	151-172	30	0,75	TW020.930
5.4	Ø 131	151-172	30	0,75	TW020.930
7.3	Ø 131	151-172	30	0,75	TW020.940
5.4	Ø 131	151-172	30	0,75	TW020.940
7.3	Ø 131	151-172	30	0,75	TW020.940
10.1	Ø 131	151-172	30	0,75	TW021.927
10.1	Ø 131	151-172	30	0,75	TW021.930
10.1	Ø 131	151-172	30	0,75	TW021.940

III  
CE IP20  
LED

## STEP 3 RIFLETTORE

REFLECTOR- REFLECTOR



Dim.	H	Kg	CODE	Col.
15°		0,05	R085S.A	01 02
24°		0,05	R085FA	01 02
38°		0,05	R085WA	01 02

CE



## STEP 4 COVER CONICA

CONIC-SHAPE COVER - CUBIERTA CÓNICA



Dim.	H	Kg	CODE	Col.
Ø 131	48	0,13	TW070	01 02 03



01 - bianco - white - blanco 02 - nero - black - negro 03 - cromo - chrome

## COVER PIANA

FLAT-SHAPE COVER - CUBIERTA PLANA



Dim.	H	Kg	CODE	Col.
Ø 131		0,09	TW071	01 02

Da abbinare esclusivamente ad ottica spot / Only to combine with spot optic / Adecuado solo por óptica spot (S)



pag.824 A pag.820

TWENTY 7



## STEP 1 TELAIIO CORNICE TONDA

TONDA- ROUND FRAME RING - MARCO REDONDO



Dim.	H	Kg	CODE	Col.
Ø 132	55	0,34	TW002	01 02

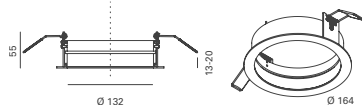

## TELAIO CORNICE QUADRA

SQUARE FRAME RING - MARCO QUADRADO



Dim.	H	Kg	CODE	Col.
Ø 132	55	0,34	TW003	01 02

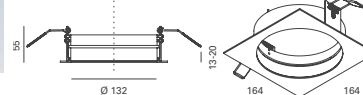

## STEP 2 GRUPPO OTTICO FISSO

FIX OPTIC GROUP- GRUPO OPTICO FIJO



LED	W	mA	K	lm product	lm/Led	CRI
3SDCM 50000h L90 B10 ta 25°	17	500	2700	1790	1790	95
	24,3	700	2700	2370	2370	95
	17	500	3000	1925	1925	95
	24,3	700	3000	2545	2545	95
	17	500	4000	2115	2115	95
	24,3	700	4000	2800	2800	95
	37,5	1050	2700	3530	3530	95
	37,5	1050	3000	3785	3785	95
	37,5	1050	4000	4155	4155	95

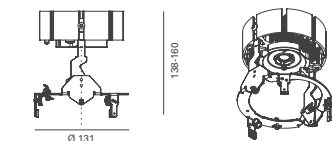

A	Dim.	H	Kg	CODE
5.4	Ø131	138-160	0,75	TW025.927
7.3				TW025.930
5.4	Ø131	138-160	0,75	TW025.940
7.3				TW025.940
10.1	Ø131	138-160	0,75	TW026.927
10.1				TW026.930
10.1				TW026.940



## STEP 3 RIFLETTORE

REFLECTOR- REFLECTOR



W	∠	Dim.	Kg	CODE
	38°	Ø90	0,03	R090W

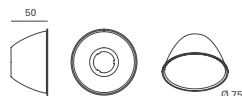

## STEP 4 LENTE

LENS- LENTE



Dim.	Kg	CODE
Ø 105	0,02	L105S
Ø 105	0,02	L105A
Ø 105	0,02	L105E
Ø 105	0,02	L105F
Ø 105	0,02	L105R

Diffusore satinato / Satin diffuser  
 Lente Asimmetrica 15° / Asymmetric Lens 15°  
 Lente Ellissoidale / Elipsoid Lens  
 Lente Fresnel / Fresnel Lens  
 Filtro nido d'ape / Honey comb louver

## STEP 5 COVER CONICA BASSA

SHORT CONIC SHAPED COVER - CUBIERTA CÓNICA BAJA



∠	17W 3000K	24,3W3 3000kK	37,5W 3000k	Dim.	H	Kg	CODE	Col.
41°	1415 lm/p	1854 lm/p	2410 lm/p	Ø 131	33	0,11	TW080	01 02 03
51°	1210 lm/p	1585 lm/p	2076 lm/p	Ø 131	33	0,11		



## TWENTY 7

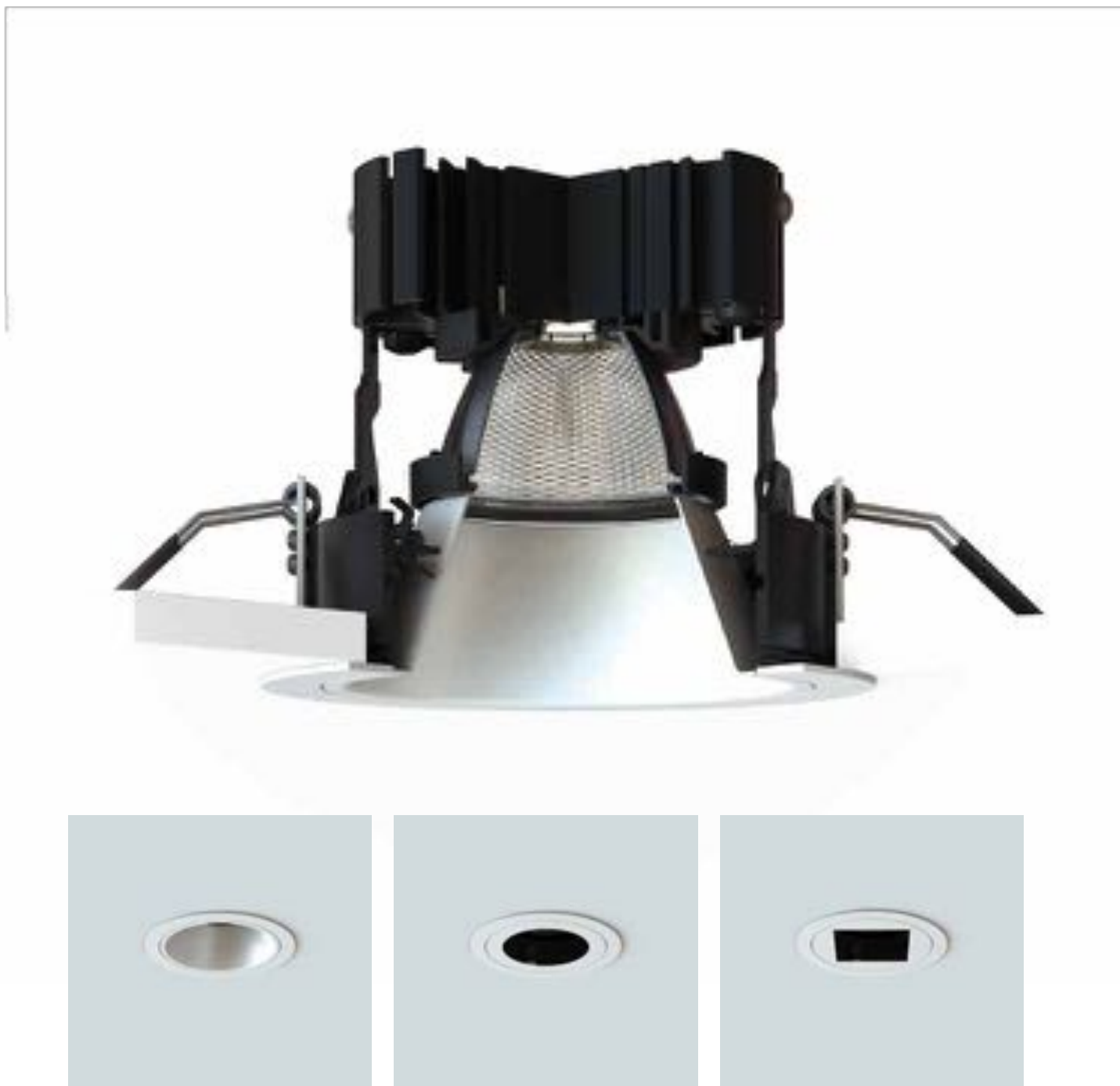

## STEP 1 TELAIO CORNICE TONDA

TONDA- ROUND FRAME RING - MARCO REDONDO

Dim.	H	Kg	CODE	Col.
Ø 132	55	0,34	TW002	01 02

## TELAI CORNICE QUADRA

SQUARE FRAME RING - MARCO QUADRADO

Dim.	H	Kg	CODE	Col.
Ø 132	55	0,34	TW003	01 02

## STEP 2 GRUPPO OTTICO FISSO

FIX OPTIC GROUP- GRUPO OPTICO FIJO

LED	W	mA	K	Im product	Im/Led	CRI	A	Dim.	H	Kg	CODE	
3SDCM 50000h L90 B10 ta 25° <b>A+</b>	17	500	2700	1790	1790	95	5.4	Ø131	138-160	0,75	TW025.927	
	24,3	700	2700	2370	2370	95	7.3					
	17	500	3000	1925	1925	95	5.4	Ø131	138-160	0,75	TW025.930	
	24,3	700	3000	2545	2545	95	7.3					
	17	500	4000	2115	2115	95	5.4	Ø131	138-160	0,75	TW025.940	
	24,3	700	4000	2800	2800	95	7.3					
	37,5	1050	2700	3530	3530	95	10.1	Ø131	138-160	0,75	TW026.927	
	37,5	1050	3000	3785	3785	95	10.1					
	37,5	1050	4000	4155	4155	95	10.1	Ø131	138-160	0,75	TW026.940	

## STEP 3 RIFLETTORE

REFLECTOR- REFLECTOR

	∠	Kg	CODE	Col.	
	15°	0,05	R085SA	01 02	
	24°	0,05	R085FA	01 02	
	38°	0,05	R085WA	01 02	

accessori - accessory  
accesorios pag. 484

## STEP 4 COVER CONICA ALTA

CONIC-SHAPE COVER - CUBIERTA CÓNICA

W	Dim.	H	Kg	CODE	Col.
	Ø131	48	0,14	TW081	01 02 03

## COVER PIANA

CLOSURE FLAT COVER - CUBIERTA PLANA

Dim.	H	Kg	CODE	Col.
Ø 131	48	0,02	TW082	01 02
Dim.	H	Kg	CODE	Col.
Ø 131	48	0,02	TW083	01 02

## TWENTY 7



## STEP 1 TELAIIO CORNICE TONDA

TONDA- ROUND FRAME RING - MARCO REDONDO



Dim.	H	Kg	CODE	Col.
Ø 132	55	0,34	TW002	01 02

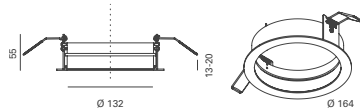

## TELAIO CORNICE QUADRA

SQUARE FRAME RING - MARCO QUADRADO



Dim.	H	Kg	CODE	Col.
Ø 132	55	0,34	TW003	01 02

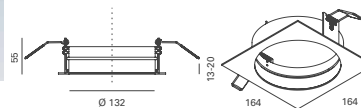

## STEP 2 GRUPPO OTTICO ORIENTABILE

DIRECTIONAL FOCUS OPTIC - AJUSTABLE OPTICA FOCUS



LED

3SDCM  
50000h L90  
B10 ta 25°C

A+

W	mA	K	Im product	Im/Led	CRI	∠
11	350	2700	985	985	95	20°
11	350	2700	985	985	95	34°
11	350	3000	1065	1065	95	20°
11	350	3000	1065	1065	95	34°
11	350	4000	1135	1135	95	20°
11	350	4000	1135	1135	95	34°

A	Dim.	H	α	Kg	CODE	Col.
3.2	Ø131	37+100	35	0,5	TW030.927S	01 02
3.2	Ø131	37+100	35	0,5	TW030.927F	01 02
3.2	Ø131	37+100	35	0,5	TW030.930S	01 02
3.2	Ø131	37+100	35	0,5	TW030.930F	01 02
3.2	Ø131	37+100	35	0,5	TW030.940S	01 02
3.2	Ø131	37+100	35	0,5	TW030.940F	01 02

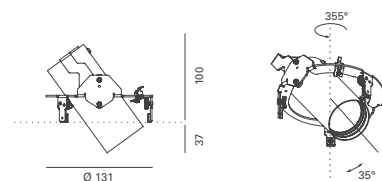

## STEP 3 COVER CONICA

CONIC-SHAPE COVER - CUBIERTA CÓNICA ORIFICIO ELÍPTICO



Dim.	H	CODE	Col.
Ø 131	48	TW070	01 02 03

## COVER PIANA

CLOSURE FLAT COVER - CUBIERTA PLANA

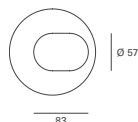

Dim.	Kg	CODE	Col.
Ø 131	0,02	TW071	01 02

01 - bianco - white - blanco 02 - nero - black - negro 03 cromo - chrome - cromo

pag.824

pag.820

## TWENTY 7



Gruppo ottico dotato di speciale meccanismo di estrazione roto-traslante.

Optical group provided with proprietary design Soft Rotate & Slide extraction mechanism.

Grupo óptico equipado con un mecanismo especial de extracción rototraslante.



## STEP 1 TELAIIO CORNICE TONDA

TONDA- ROUND FRAME RING - MARCO REDONDO



Dim.	H	Kg	CODE	Col.
Ø 132	55	0,34	TW002	01 02

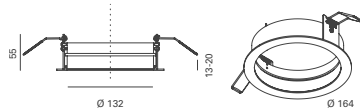

## TELAIO CORNICE QUADRA

SQUARE FRAME RING - MARCO QUADRATO



Dim.	H	Kg	CODE	Col.
Ø 132	55	0,34	TW003	01 02

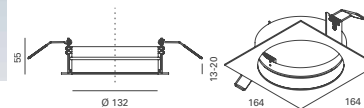

## STEP 2 GRUPPO OTTICO 90 ORIENTABILE ED ESTRAIBILE

FOCUS 90 OPTIC - OPTICA FOCUS 90



LED	W	mA	K	lm product	lm/Led	CRI
3SDCM 50000h L90 B10 ta 25°	17	500	2700	1790	1790	95
	24,3	700	2700	2370	2370	95
	17	500	3000	1925	1925	95
	24,3	700	3000	2545	2545	95
	17	500	4000	2115	2115	95
	24,3	700	4000	2800	2800	95
	37,5	1050	2700	3530	3530	95
	37,5	1050	3000	3785	3785	95
	37,5	1050	4000	4155	4155	95

A+

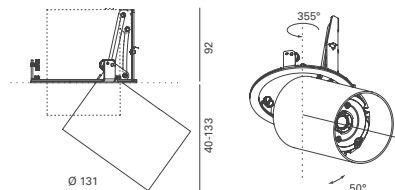

A	Dim.	H	α	Kg	CODE	Col.
5.4	Ø131	133+92	50	1,01	TW035.927	01 02
7.3						
5.4	Ø131	133+92	50	1,01	TW035.930	01 02
7.3						
5.4	Ø131	133+92	50	1,01	TW035.940	01 02
7.3						
10.1	Ø131	133+92	50	1,01	TW036.927	01 02
10.1						
10.1	Ø131	133+92	50	1,01	TW036.930	01 02
10.1						



## STEP 3 RIFLETTORE

REFLECTOR- REFLECTOR



15°  
24°  
38°

Kg	CODE
0,05	R085S.A
0,05	R085FA
0,05	R085W.A



accessori - accessory  
accesorios pag. 484

01 - bianco - white - blanco 02 - nero - black - negro

pag.824

pag.820

Accessori - Accessories - Accesorios

## LENTE CON ANELLO

LENSES WITH RING - LENTES CON ANILLO



LENTE SATINATA CON ANELLO / SATIN LENS WITH RING / LENTE SATINADA CON ANILLO

Dim.

Kg

CODE

Col.

Ø 85

0,02

L085SA

01 02



LENTE FRESNEL CON ANELLO / FRESNEL LENS WITH RING / LENTE FRESNEL CON ANILLO

Dim.

Kg

CODE

Col.

Ø 85

0,02

L085FA

01 02



LENTE ELISSOIDALE CON ANELLO / ELIPSOID LENS WITH RING / LENTE ELIPSOIDAL CON ANILLO

Dim.

Kg

CODE

Col.

Ø 85

0,02

L085EA

01 02



LENTE ASIMMETRICA CON ANELLO / ASYMMETRIC LENS WITH RING / LENTE ASIMÉTRICA CON ANILLO

Dim.

Kg

CODE

Col.

Ø 85

0,02

L085AA

01 02



FILTRO NIDO D'APE CON ANELLO / HONEY COMB LOUVER WITH RING / REJILLA DE NIDO DE ABEJA CON ANILLO

Dim.

Kg

CODE

Col.

Ø 85

0,02

L085RA

01 02



## LENTE

LENS - LENTE



LENTE SATINATA / SATIN LENS / LENTE SATINADA

Dim.

Kg

CODE

Ø 105

0,02

L105S



LENTE FRESNEL / FRESNEL LENS / LENTE FRESNEL

Dim.

Kg

CODE

Ø 105

0,02

L105F



LENTE ELISSOIDALE / ELIPSOID LENS / LENTE ELIPSOIDAL

Dim.

Kg

CODE

Ø 105

0,02

L105E



LENTE ASIMMETRICA / ASYMMETRIC LENS / LENTE ASIMÉTRICA

Dim.

Kg

CODE

Ø 105

0,02

L105A



FILTRO NIDO D'APE / HONEY COMB LOUVER / REJILLA DE NIDO DE ABEJA

Dim.

Kg

CODE

Ø 105

0,02

L105R



01 - bianco - white - blanco 02 - nero - black - negro





## LIGHT-DRUM



Apparecchio da incasso a soffitto, rasato a scomparsa totale trimless, composto da un box di copertura in metallo verniciato di sezione cilindrica da fissare, stuccare e rasare nel cartongesso. Da completare con proiettori orientabili, da agganciare al box con magneti, per sorgenti led professionali (incluse) o per lampade alogene/LED QR-CB 51 e QR-LP 111 12V/230V, QPAR16. Da completare con i gruppi di alimentazione 12V/230V o 230V/240V indicati.

Trimless recessed downlight made of a painted cylindrical metal cover box to fix and plaster into the plasterboard false-ceiling. To complete with directional projectors, to fix to the metal box, for 12V/230V QR-CB 51 and QR-LP 111 12V/230V or 230V QPAR16 LED/halogen lamps. To complete with 12V/230V transformer or 230V/240V control-gear box reported.

Aparato para empotrar en techo, totalmente enrasado, trimless, compuesto por una caja en metal barnizado de forma cilíndrica para fijar, enyesar y enrasar en el cartón-yeso. Se complementa con proyectores orientables, que se enganchan en la caja con imanes, para led profesionales (incluidos) o para lámparas halógenas(LED QR-CB-51 y QR-LP111 12V/230V, QPAR16y. A complementar con los grupos de alimentación 12V/230V o 230V/240V indicados.

## LIGHT-DRUM STRUCTURA

BOX - ESTRUCTURA

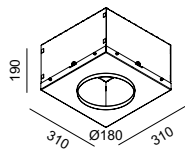

CODE	Col.
<b>DRUM</b>	<b>02</b>

## LIGHT-DRUM PROIETTORI

PROJECTORS - PROYECTORES



	W	mA	K	lm product	lm/Led	CRI	∠	A	Dim.	H	CODE	Col.	
LED  3SDCM 50000h L90 B10 ta 25°C <b>A+</b>	11	350	2700	931	1100	>90	29°	<b>3.2</b>	ø55	125	<b>DR51.927S</b>	<b>02</b>	
	11	350	2700	703	1100	>90	42°	<b>3.2</b>	ø55	125	<b>DR51.927F</b>	<b>02</b>	
	11	350	3000	1003	1185	>90	29°	<b>3.2</b>	ø55	125	<b>DR51.930S</b>	<b>02</b>	
	11	350	3000	757	1185	>90	42°	<b>3.2</b>	ø55	125	<b>DR51.930F</b>	<b>02</b>	
	11	350	4000	1088	1285	>90	29°	<b>3.2</b>	ø55	125	<b>DR51.940S</b>	<b>02</b>	
	11	350	4000	821	1285	>90	42°	<b>3.2</b>	ø55	125	<b>DR51.940F</b>	<b>02</b>	

	W	A	Dim.	H	CODE	Col.	
QR-CB51 GU5,3 12V <b>A+-D</b>	MAX 50	<b>T.1</b>	ø55	125	<b>DR51Q</b>	<b>02</b>	

	W	A	Dim.	H	CODE	Col.	
QPAR16 GU10 230V <b>A+-D</b>	MAX 50		ø55	125	<b>DR51G</b>	<b>02</b>	

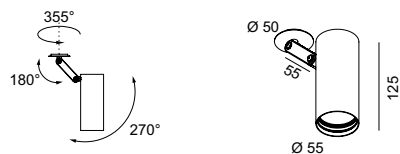

	W	A	Dim.	CODE	Col.	
QR-LP 111 G53 12V <b>A+-D</b>	MAX 1x60	<b>T.2</b>	ø115	<b>DR50</b>	<b>02</b>	

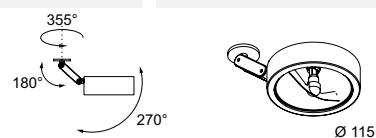
**02** - nero - black - negro

pag.824

**A** pag.820

---

La fusione di due funzioni in un unico apparecchio da incasso professionale  
MOVE reinventa il classico incasso cardanico orientabile, unendo in un'unica tipologia di apparecchio due funzioni distinte: quella del classico apparecchio da incasso orientabile sia sull'asse orizzontale che su quello verticale e quella del proiettore da incasso con gruppo ottico di forma cilindrica, non solo orientabile sui due assi, ma anche estraibile. Le due tipologie di apparecchio sono installabili sullo stesso corpo lampada – da installare in controsoffitto – mediante sistema a calamita Click and Play di fissaggio e sgancio. Il corpo lampada, di forma quadrata, può alloggiare uno o due apparecchi, anche misti tra i due sopra elencati. Disponibile in versione a scomparsa totale o con cornice di battuta. LED chip on board, ottiche spot, flood e wide. Accessori: lenti Fresnel, satinata, ellissoidale, asimmetrica e griglia antiabbagliamento.

The merge of two lighting functions in one downlighter –  
With MOVE, Lucifero's reinvents the traditional adjustable cardanic downlighter, merging in one fixture two distinct functions: that of the traditional cardanic downlighter, adjustable on the horizontal and on the vertical axis and that of the recessed projector, not only adjustable but also extractable. The two "functions" are incorporated within two different optical groups, but both can be installed, according to the desired function, onto the same fixture's body, thanks to a tool-free Click&Play magnetic lock-unlock system. The fixture's body can host one or two optical groups, of the same type of mixed, and is available with frame or trimless. Chip on board, LED – Optics: spot, flood and wide. Accessories: frosted, asymmetrical, ellipsoidal, Fresnel lenses and honey-comb louvre

La fusión de dos funciones en un único aparato para empotrar profesional MOVE reinventa el clásico empotrado de cardan orientable, uniendo en un solo tipo de aparato dos funciones distintas: la del aparato clásico para empotrar orientable, tanto en el eje horizontal como en el vertical y la del proyector para empotrar con el grupo óptico de forma cilíndrica, no solo se puede orientar en ambos ejes, sino también es extraíble. Los dos tipos de aparato se pueden instalar en el mismo cuerpo de la lámpara -para montar en falso techo- mediante el sistema magnético Click and Play de fijación y desenganche. El cuerpo de la lámpara, de forma cuadrada, puede alojar uno o dos aparatos, incluso combinados de los dos antes mencionados. Disponible en las versiones totalmente empotrada o con marco de tope. LED chip on board, óptica spot, flood y wide. Accesorios: lentes Fresnel, satinada, elipsoidal, asimétrica y rejilla antideslumbramiento.

# MOVE

## MOVE EKO



## MOVE MINIMAL



## MOVE FRAME



## MOVE SYSTEM

SISTEMA - SYSTEM - SISTEMA

### MOVE MINIMAL

### MOVE FRAME

1

**ANELLO  
RING  
ANILLO**



Minimal 1 / MInimal 1

Minimal 2 / MInimal 2



Frame 1 / Frame 1

Frame 2 / Frame 2

2

**GRUPPO OTTICO/  
OPTIC GROUP  
GRUPO OPTICO**

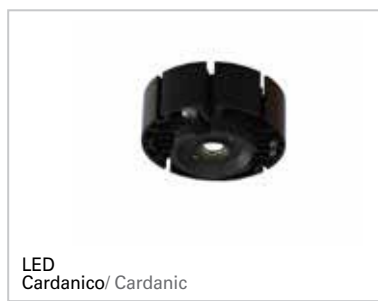

LED  
Cardanico / Cardanic



LED  
Telescopico / Telescopic

3

**RIFLETTORE/  
REFLECTOR  
REFLECTO**



4

**GRUPPO CARDANICO/  
CARDANIC KIT**





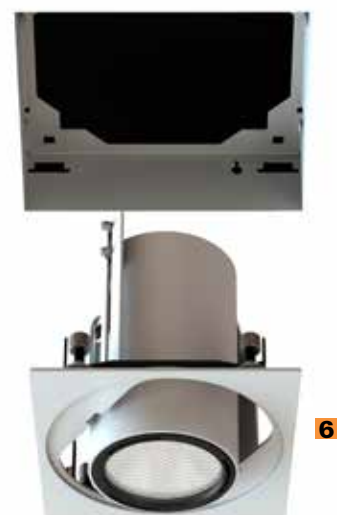

- 1** Dissipatore con disegno esclusivo / Heat sink with exclusive design
- 2** Modulo Led ad alta resa cromatica / High color rendering index Led module
- 3** Riflettore intercambiabile ad aggancio rapido / Easy lock interchangeable reflector
- 4** Schermo trasparente / Transparent diffuser
- 5** Corpo ottico cardanico con magneti / Cardanic optic body with magnets
- 6** Corpo ottico focus con magneti / Focus optic body with magnets

#### ACCESSORI / ACCESSORIES

- A** Diffusore satinato / Satin diffuser L105S
- B** Lente Elissoidale / Elipsoid Lens L105E
- C** Lente Fresnel / Fresnel Lens L105F
- D** Lente Asimmetrica 15° / Asymmetric Lens 15° L105A
- E** Filtro nido d'ape / Honey comb louver L105R







Programma di incassi orientabili a soffitto per sorgenti LED Chip On Board integrate. Cornice di battuta di forma quadrata, ad uno o due vani. Gruppo ottico orientabile di 355° sull'asse verticale e +/-20° sull'asse orizzontale. Corpo lampada e gruppo ottico in lamiera di acciaio verniciato. Riflettore metallizzato in alluminio purissimo 99,99%. Accessori: lenti satinata, asimmetrica, ellissoidale, Fresnel in policarbonato e griglia a nido d'ape antiabbagliamento in alluminio anodizzato nero. Grado di protezione IP20/23.

Recessed adjustable downlighters programme for chip on board LED sources. Square frame 1x and 2x. Optical group 355° vertically and +/-20° horizontally adjustable. Fixture's body and optical group in painted steel. Reflector coated with 99,99% pure aluminum. Accessories: Fresnel, frosted, asymmetrical, ellipsoidal lenses in polycarbonate, and honeycomb grid anodized black aluminum. Degree of protection IP20/23.

Programa de empotrables orientables de techo para fuentes LED Chip On Board integradas. Marco de tope de forma cuadrada, con uno o dos compartimentos. Grupo óptico orientable de 355° en el eje vertical y +/-20° en el eje horizontal. Cuerpo de la lámpara y grupo óptico en chapa de acero pintado. Reflector metalizado de aluminio puro 99,99%. Accesorios: lente satinada, asimétrica, elipsoidal, Fresnel de policarbonato y rejilla de nido de abeja antideslumbramiento de aluminio anodizado negro. Grado de protección IP20/23.

**MOVE EKO**



DOWLIGHTERS

# MOVE EKO1

165x165



LED	W	mA	K	lm product	lm/Led	CRI	△	A	Dim.	H	CODE	Col.
	17	500	2700	1438	1790	95	15°	5.4	178x178	70	MV100.927S	01 02
	24,3	700	2700	1904	2370	95		7.3				
	17	500	2700	1530	1790	95	24°	5.4	178x178	70	MV100.927F	01 02
	24,3	700	2700	2011	2370	95		7.3				
	17	500	2700	1609	1790	95	38°	5.4	178x178	70	MV100.927W	01 02
	24,3	700	2700	2095	2370	95		7.3				
	17	500	3000	1546	1925	95	15°	5.4	178x178	70	MV100.930S	01 02
	24,3	700	3000	2045	2545	95		7.3				
	17	500	3000	1645	1925	95	24°	5.4	178x178	70	MV100.930F	01 02
	24,3	700	3000	2160	2545	95		7.3				
	17	500	3000	1730	1925	95	38°	5.4	178x178	70	MV100.930W	01 02
	24,3	700	3000	2250	2545	95		7.3				
	17	500	4000	1699	2115	95	15°	5.4	178x178	70	MV100.940S	01 02
	24,3	700	4000	2250	2800	95		7.3				
	17	500	4000	1807	2115	95	24°	5.4	178x178	70	MV100.940F	01 02
	24,3	700	4000	2376	2800	95		7.3				
	17	500	4000	1901	2115	95	38°	5.4	178x178	70	MV100.940W	01 02
	24,3	700	4000	2475	2800	95		7.3				

3SDCM  
50000h L90  
B10 ta 25°

A+

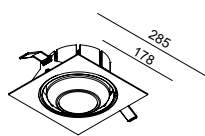
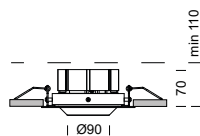

accessori - accessories -  
accesorios pag. 504

# MOVE EKO2

165x318



LED	W	mA	K	lm product	lm/Led	CRI	△	A	Dim.	H	CODE	Col.
3SDCM 50000h L90 B10 ta 25° <b>A+</b>	2x17	500	2700	2875	3580	95	15°	5.4	332x178	70	MV200.927S	01 02
	2x24,3	700	2700	3809	4740	95	15°	7.3	332x178	70	MV200.927F	01 02
	2x17	500	2700	3059	3580	95	24°	5.4	332x178	70	MV200.927F	01 02
	2x24,3	700	2700	4023	4740	95	24°	7.3	332x178	70	MV200.927W	01 02
	2x17	500	2700	3217	3580	95	38°	5.4	332x178	70	MV200.927W	01 02
	2x24,3	700	2700	4190	4740	95	38°	7.3	332x178	70	MV200.930S	01 02
	2x17	500	3000	3092	3850	95	15°	5.4	332x178	70	MV200.930S	01 02
	2x24,3	700	3000	4090	5090	95	15°	7.3	332x178	70	MV200.930F	01 02
	2x17	500	3000	3290	3850	95	24°	5.4	332x178	70	MV200.930F	01 02
	2x24,3	700	3000	4320	5090	95	24°	7.3	332x178	70	MV200.930W	01 02
	2x17	500	3000	3460	3850	95	38°	5.4	332x178	70	MV200.930W	01 02
	2x24,3	700	3000	4500	5090	95	38°	7.3	332x178	70	MV200.940S	01 02
	2x17	500	4000	3397	4230	95	15°	5.4	332x178	70	MV200.940S	01 02
	2x24,3	700	4000	4500	5600	95	15°	7.3	332x178	70	MV200.940F	01 02
	2x17	500	4000	3615	4230	95	24°	5.4	332x178	70	MV200.940F	01 02
	2x24,3	700	4000	4753	5600	95	24°	7.3	332x178	70	MV200.940W	01 02
	2x17	500	4000	3802	4230	95	38°	5.4	332x178	70	MV200.940W	01 02
	2x24,3	700	4000	4950	5600	95	38°	7.3	332x178	70	MV200.940W	01 02

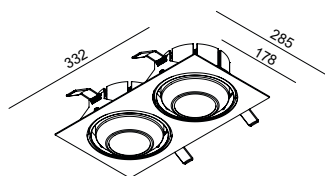
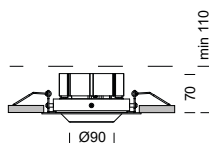

DOWNLIGHTERS

01 - bianco - white - blanco 02 - nero - black - negro

 pag.824

**A** pag.820

Programma di incassi e proiettori da incasso a soffitto per sorgenti LED Chip On Board integrate. Studiato per ottenere, mediante la semplice aggiunta di accessori al corpo lampada, due diverse soluzioni illuminotecniche: incasso orientabile e proiettore da incasso orientabile ed estraibile. Disponibili in versione rasata a scomparsa totale e con cornice di battuta, di forma quadrata, ad uno o due vani. Incasso cardanico: orientabile di 355° sull'asse verticale e +/-20° sull'asse orizzontale. Proiettore focus: estraibile ed orientabile di 355° sull'asse verticale e +/-55° sull'asse orizzontale, grazie ad uno speciale meccanismo roto-traslante. Corpo lampada da incassare a soffitto in alluminio verniciato. Gruppo ottico, in alluminio verniciato, provvisto di sistema Click and Play di fissaggio e sgancio con il corpo lampada, mediante calamite tubolari e di cavo di acciaio di sicurezza. Riflettore metallizzato in alluminio purissimo 99,99%. Accessori: lenti Fresnel, satinata, asimmetrica, ellissoidale in policarbonato e griglia a nido d'ape antiabbagliamento in alluminio anodizzato nero. Grado di protezione IP20/23.

Recessed downlighters and projectors programme for chip on board LED sources. Conceived to get, by the insertion of accessories into the fixture body, two different lighting solutions: adjustable downlighter and extractable and adjustable projector. Available with frame and in trimless version, 1x and 2x. Recessed cardanic downlighter: 355° vertically and +/-20° horizontally adjustable optical group. Focus projector: extractable and 355° vertically and +/-55° horizontally adjustable, thanks to a patented Soft Rotate & Slide mechanism. Fixture's body in painted aluminum. Optical group, in painted aluminum, provided with Click&Play magnetic lock-unlock system to the fixture's body and safety steel cable. Accessories: Fresnel, satin, asymmetrical, ellipsoidal lenses in polycarbonate and honeycomb grid anodized black aluminum.. Degree of protection IP20/23.

Programa de empotrables y proyectores para empotrar al techo para fuentes LED Chip On Board integradas. Diseñado para lograr, mediante la simple adición de accesorios al cuerpo de la lámpara, dos soluciones diferentes de iluminación: de montaje empotrado orientable y proyector para empotrar orientable y extraíble. Disponible en la versión a ras totalmente empotrable y con marco de tope, de forma cuadrada, con uno o dos compartimentos. Empotrado de cardan orientable de 355° en el eje vertical y +/-20° en el eje horizontal. Proyector focus: extraíble y orientable de 355° en el eje vertical y +/-55° en el eje horizontal, gracias a un especial mecanismo rototraslante. Cuerpo de la lámpara para empotrar en el techo de aluminio pintado. Grupo óptico, de aluminio pintado, con sistema Click and Play de fijación y desenganche del cuerpo de la lámpara, por medio de imanes tubulares y un cable de seguridad de acero. Reflector metalizado de aluminio puro 99,99%. Accesorios: lentes Fresnel, satinada, asimétrica, elipsoidal, de policarbonato y rejilla de nido de abeja antideslumbramiento de aluminio anodizado negro. Grado de protección IP20/23.





**MOVE**



## MOVE CARDANIC

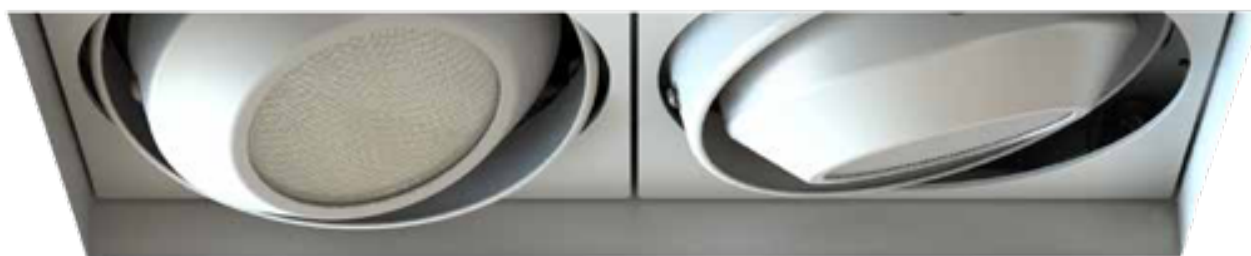

STEP 1

**CASSA TRIMLESS**

TRIMLESS BOX - CAJA MINIMALE

162x162 Ø 143



Dim.	H	Kg	CODE
160x160	8/30	0,17	<b>MV001 01 02</b>

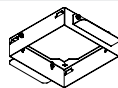
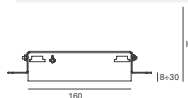

162x318 Ø 143



Dim.	H	Kg	CODE
160X316	8/30		<b>MV002 01 02</b>

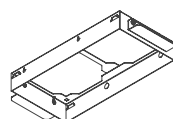
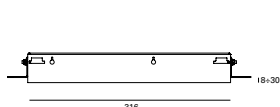

**CASSA CON CORNICE**

FRAME BOX- CAJA CON MARCO

165x165



Dim.	H	Kg	CODE	Col.
164X164	8/30	0,34	<b>MV011</b>	<b>01 02</b>

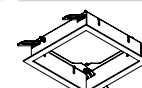
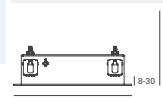

165x322



Dim.	H	Kg	CODE	Col.
164X340	8/30		<b>MV012</b>	<b>01 02</b>

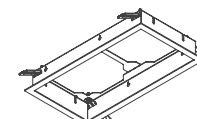
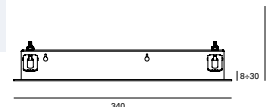

STEP 2

**GRUPPO OTTICO CARDANICO**

CARDANIC OPTIC GROUP - CUERPO ÓPTICO DE CARDAN CON IMANES



LED	W	mA	K	lm product	lm/Led	CRI	A	CODE	Col.
LED	17	500	2700	1790	1790	95	5.4	<b>MV050.927</b>	<b>01 02</b>
	24,3	700	2700	2370	2370	95	7.3		
3SDCM 50000h L90 B10 ta 25°	17	500	3000	1925	1925	95	5.4	<b>MV050.930</b>	<b>01 02</b>
	24,3	700	3000	2545	2545	95	7.3		
A+	17	500	4000	2115	2115	95	5.4	<b>MV050.940</b>	<b>01 02</b>
	24,3	700	4000	2800	2800	95	7.3		

STEP 3

**RIFLETTORE**

REFLECTOR- REFLECTOR



Angle	Dim.	H	Kg	CODE
15°	Ø75	50	0,03	<b>R075.S.V</b>
24°	Ø75	50	0,03	<b>R075.F.V</b>
38°	Ø75	50	0,03	<b>R075.W.V</b>

Completo di vetro/Glass included/Ver incluido



accessori - accessories - accesorios pag. 504

STEP 4

**CORPO CARDANICO**

CARDANIC BODY- CUERPO DE CARDAN



Dim.	H	Kg	CODE	Col.
154x154	100		<b>MV021</b>	<b>01 02</b>

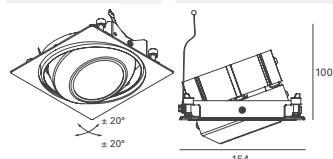

01 - bianco - white - blanco 02 - nero - black - negro



pag.824



pag.820

## MOVE FOCUS



STEP 1

**CASSA TRIMLESS**

TRIMLESS BOX - CAJA MINIMALE

162x162 Ø 143



Dim.	H	Kg	CODE	Col.
160x160	8/30	0,17	MV001	01 02

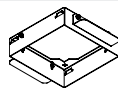
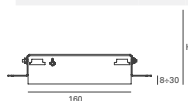

162x318 Ø 143



Dim.	H	Kg	CODE	Col.
160X316	8/30		MV002	01 02

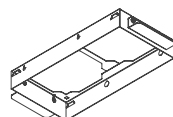
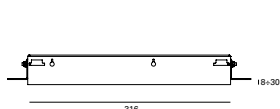

**CASSA CON CORNICE**

FRAME BOX- CAJA CON MARCO

165x165



Dim.	H	Kg	CODE	Col.
164X164	8/30	0,34	MV011	01 02

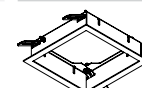
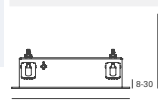

165x322



Dim.	H	Kg	CODE	Col.
164X340	8/30		MV012	01 02

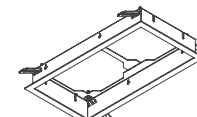
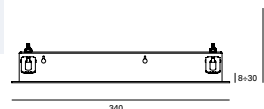

STEP 2

**GRUPPO OTTICO FOCUS**

FOCUS OPTIC GROUP - CUERPO FOCUS



	W	mA	K	Im product	ImLed	CRI	∠	A	CODE	Col.
LED	17	500	2700	1790	1790	95		5.4	MV055.927	01 02
	24,3	700	2700	2370	2370	95		7.3		
3SDCM 50000h L90 B10 ta 25°	17	500	3000	1925	1925	95		5.4	MV055.930	01 02
	24,3	700	3000	2545	2545	95		7.3		
A+	17	500	4000	2115	2115	95		5.4	MV055.940	01 02
	24,3	700	4000	2800	2800	95		7.3		
A+	37,5	1050	2700	3530	3530	95		10.1	MV056.927	01 02
	37,5	1050	3000	3785	3785	95		10.1		
	37,5	1050	4000	4155	4155	95		10.1		

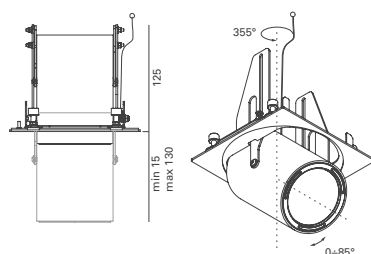

STEP 3

**RIFLETTORE**

REFLECTOR- REFLECTOR



Optic	Dim.	H	Kg	CODE	Col.
15°	Ø85	50	0,05	R085S.A	01 02
24°	Ø85	50	0,05	R085FA	01 02
38°	Ø85	50	0,05	R085WA	01 02



accessori - accessories -  
accesorios pag. 504

01 - bianco - white - blanco 02 - nero - black - negro



pag.824



pag.820

## LENTE CON ANELLO

LENSES WITH RING - LENTES CON ANILLO



LENTE SATINATA CON ANELLO / SATIN LENS WITH RING / LENTE SATINADA CON ANILLO

Dim. Kg CODE Col.

Ø 85 0,02 L085SA 01 02



LENTE FRESNEL CON ANELLO / FRESNEL LENS WITH RING / LENTE FRESNEL CON ANILLO

Dim. Kg CODE Col.

Ø 85 0,02 L085FA 01 02



LENTE ELISSOIDALE CON ANELLO / ELIPSOID LENS WITH RING / LENTE ELIPSOIDALE CON ANILLO

Dim. Kg CODE Col.

Ø 85 0,02 L085EA 01 02



LENTE ASIMMETRICA CON ANELLO / ASYMMETRIC LENS WITH RING / LENTE ASIMÉTRICA CON ANILLO

Dim. Kg CODE Col.

Ø 85 0,02 L085AA 01 02



FILTRO NIDO D'APE CON ANELLO / HONEY COMB LOUVER WITH RING / REJILLA DE NIDO DE ABEJA CON ANILLO

Dim. Kg CODE Col.

Ø 85 0,02 L085RA 01 02



## LENTI

LENS - LENTE



LENTE SATINATA / SATIN LENS / LENTE SATINADA

Dim. Kg CODE

Ø 105 0,02 L105S



LENTE FRESNEL / FRESNEL LENS / LENTE FRESNEL

Dim. Kg CODE

Ø 105 0,02 L105F



LENTE ELISSOIDALE / ELIPSOID LENS / LENTE ELIPSOIDALE

Dim. Kg CODE

Ø 105 0,02 L105E



LENTE ASIMMETRICA / ASYMMETRIC LENS / LENTE ASIMÉTRICA

Dim. Kg CODE

Ø 105 0,02 L105A



FILTRO NIDO D'APE / HONEY COMB LOUVER / REJILLA DE NIDO DE ABEJA

Dim. Kg CODE

Ø 105 0,02 L105R







ROCHE BOBOIS ROMA - ITALY  
PHOTO G. CONESE



## INCAS SPOT

Apparecchio da incasso a parete e soffitto, orientabile per illuminazione d'accento, per lampade LED/alogene QR-LP 111 G53 12V/230V. Disponibile con cornice di battuta o a scomparsa totale trimless. Corpo, gruppo ottico e cornice di battuta super-slim larghezza 18 mm. in metallo verniciato o cromato. Gruppo ottico orientabile di 355° sull'asse verticale e +/- 40° su quello orizzontale. Alimentazione remota disponibile come accessorio. Modelli plurilampada predisposti per accensioni separate. Completabile con cassa in metallo verniciato per installazione a plafone e a sospensione. Installabile in pareti e soffitti in calcestruzzo mediante apposita cassaforma in lamiera zincata. Grado di protezione IP20/IP23.

Recessed downlight for wall and ceiling installation, adjustable, for accent lighting, for LED/halogen QR-LP 111 G53 12V/230V lamps. Available in version with frame or trimless. Body optical group and super-slim 18 mm width frame in painted or chromed metal. Optical group adjustable 355° vertically and +/- 40° horizontally. Remote power-supply available as an accessory. Multi-lamp models set up for separate switching. It can also be completed with painted metal box for ceiling and hanging installation. It can also be installed in concrete or brick walls through specific galvanized steel wall-box, available as an accessory. Degree of protection IP20/IP23.

Lámpara empotrable para pared y techo, para iluminación de realce, ajustable para lámparas LED/halógenas QR-LP 111 G53 12V/230V. Disponible en version con o sin marco. Cuerpo, grupo óptico y marco super-slim 18 mm de ancho. En metal pintado o cromado. Grupo óptico ajustable 355° vertical y +/- 40° en horizontal. Reactancia remota disponible como accesorio. Modelos de lámparas preparados para interruptores separados. Se puede instalar también con caja de metal pintado para instalación en el techo y suspensión, o en paredes de hormigón, usando una caja en lámina de zinc o de aluminio, disponible como accesorio. Grado de protección IP20/IP23.





CENTRO COMMERCIALE CONÈ CONEGLIANO VENETO - ITALY  
PHOTO M. FLORES





BIANCOSPINO BOUTIQUE PESCARA - ITALY  
PROJECT ARCH. G. LETTERE





01



02

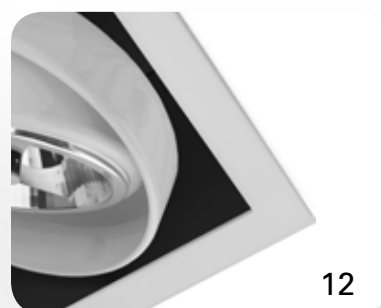

12



31



32



33



34

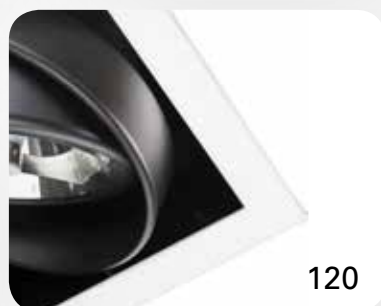

120



122

01 BIANCO - WHITE - BLANCO

02 NERO - BLACK - NEGRO

12 CASSA NERA - CORNICE GRIGIA - ANELLI GRIGI-BLACK BOX - GREY FRAME - GREY RING - CAJA NEGRA - MARCO GRIS - ANILLA GRIS

31 CASSA BIANCA - CORNICE BIANCA - ANELLI CROMO -WHITE BOX - WHITE FRAME - CHROME RINGS - CAJA BLANCA - MARCO BLANCA - ANILLAS CROMO

32 CASSA NERA - CORNICE BIANCA - ANELLI CROMO-BLACK BOX - WHITE FRAME - CHROME RINGS - CAJA NEGRA - MARCO BLANCO - ANILLAS CROMO

33 CASSA NERA - CORNICE CROMO - ANELLI CROMO-BLACK BOX - CHROME FRAME- CHROME RING - CAJA NEGRA - MARCO CROMO - ANILLA CROMO

34 CASSA NERA - CORNICE CROMO - ANELLI NERI - BLACK BOX - CHROME FRAME - BLACK RING - CAJA NEGRA - MARCO CROMO - ANILLA NEGRA

120 CASSA NERA - CORNICE BIANCA - ANELLI NERI BLACK BOX - WHITE FRAME - BLACK RINGS - CAJA NEGRA - MARCO BLANCO - ANILLAS CROMO

122 CASSA BIANCA - CORNICE CROMO - ANELLI BIANCHI -WHITE BOX - CHROME FRAME - WHITE RING - CAJA BLANCA - MARCO CROMO - ANILLA BLANCA

## INCAS 1A

162X162



QR-LP 111 G53 12V  
 max 1x60

A

Kg  
 1,5

CODE  
 IN01A

Col.  
 01 02 12 31 32  
 33 34 120 122



\* In caso di utilizzo con cassa per installazione esterna non superare i 35W | In case of use within surface mounted box do not pass 35W | En caso de uso con caja de metal para la instalación techo no exceda 35W.

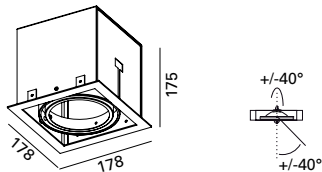

accessori - accessories- accesorios pag.520

## INCAS 2A

316X162



QR-LP 111 G53 12V  
 max 2x60

A

Kg  
 2,3

CODE  
 IN02A

Col.  
 01 02 12 31 32  
 33 34 120 122



\* In caso di utilizzo con cassa per installazione esterna non superare i 35W | In case of use within surface mounted box do not pass 35W | En caso de uso con caja de metal para la instalación techo no exceda 35W.

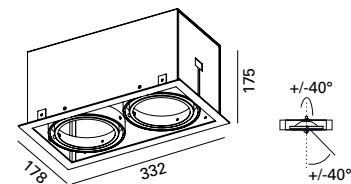



accessori - accessories- accesorios pag.520



## INCAS 3A

470X162



QR-LP 111 G53 12V  
  W max 3x60

A 

Kg 2,9

CODE IN03A

Col. 01 02 12 31 32  
33 34 120 122



\* In caso di utilizzo con cassa per installazione esterna non superare i 35W | In case of use within surface mounted box do not pass 35W | En caso de uso con caja de metal para la instalaci3n techo no exceda 35W.

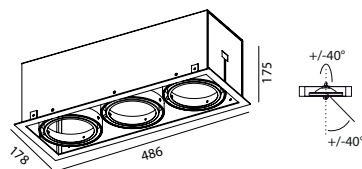



accessori - accessories- accesorios pag.520

## INCAS 4A

316X316



QR-LP 111 G53 12V  
  W max 4x60

A 

Kg 3,6

CODE IN04A

Col. 01 02 12 31 32  
33 34 120 122



\* In caso di utilizzo con cassa per installazione esterna non superare i 35W | In case of use within surface mounted box do not pass 35W | En caso de uso con caja de metal para la instalaci3n techo no exceda 35W.

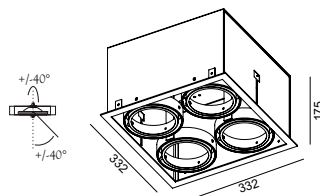

accessori - accessories- accesorios pag.520

01 02 12 31 32 33 34 120 122 COMBINAZIONE COLORI - FINISHINGS - ACABADOS PAG.511

 pag.824

**A** pag.820

## INCAS 1AM

pag.521



QR-LP 111 G53 12V  
W max 1x60



B→C

A

T.2

Kg

1,3

CODE

IN01AM

Col.

01 02 12 31 32



Da completare con telaio o staffe per controsoffitto o cassaforma per cemento/laterizio | To be completed with frame for false ceiling or wallbox brick/concrete | A completar con marco o el techo encofrado para hormigón / ladrillo

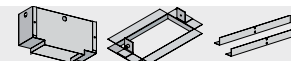
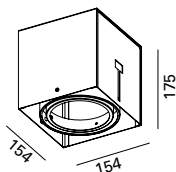

accessori - accessories- accesorios pag.521

## INCAS 2AM

pag.521



QR-LP 111 G53 12V  
W max 2x60



B→C

A

T.2

Kg

2,0

CODE

IN02AM

Col.

01 02 12 31 32



Da completare con telaio o staffe per controsoffitto o cassaforma per cemento/laterizio | To be completed with frame for false ceiling or wallbox brick/concrete | A completar con marco o el techo encofrado para hormigón / ladrillo

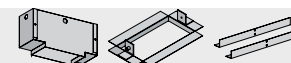
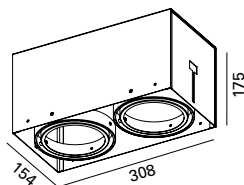

accessori - accessories- accesorios pag.521

01 02 12 31 32

COMBINAZIONE COLORI - FINISHINGS - ACABADOS PAG.511

pag.824

A pag.820

## INCAS 3AM

pag.521



QR-LP 111 G53 12V  
W max 3x60



B→C

A

T.2

Kg

2,5

CODE

IN03AM

Col.

01 02 12 31 32



Da completare con telaio o staffe per controsoffitto o cassaforma per cemento/laterizio | To be completed with frame for false ceiling or wallbox brick/concrete | A completar con marco o el techo encofrado para hormigón / ladrillo

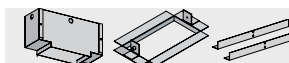
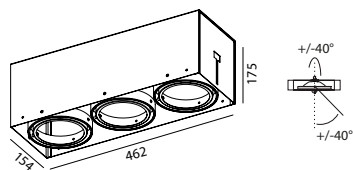

accessori - accessories- accesorios pag.521

## INCAS 4AM

pag.521



QR-LP 111 G53 12V  
W max 4x60



B→C

A

T.2

Kg

3,2

CODE

IN04AM

Col.

01 02 12 31 32



Da completare con telaio o staffe per controsoffitto o cassaforma per cemento/laterizio | To be completed with frame for false ceiling or wallbox brick/concrete | A completar con marco o el techo encofrado para hormigón / ladrillo

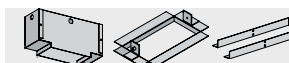
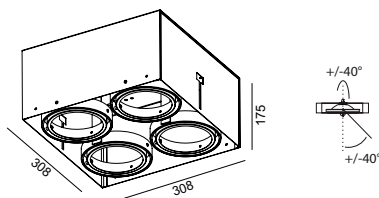

accessori - accessories- accesorios pag.521

01 02 12 31 32

COMBINAZIONE COLORI - FINISHINGS - ACABADOS PAG.511

pag.824

A pag.820

---

## INCAS SPOT

Apparecchio da incasso solo a soffitto per illuminazione diffusa, completo di sorgenti lineari LED 220V o per lampade fluorescenti compatte TC-TEL GX24 q3/4, completo di schermo diffondente in PMMA opalino bianco e alimentazione elettronica 50/60Hz 230/240V. Corpo e cornice di battuta super-slim larghezza 18 mm. in metallo verniciato o cromato. Completabile con cassa in metallo verniciato per installazione a plafone e a sospensione. Installazione in soffitti in calcestruzzo mediante apposita cassaforma in lamiera zincata. Grado di protezione IP43.

Recessed downlight for ceiling installation only, for diffused lighting, complete with linear LED 220V sources or for TC-TEL GX24 q3/-4 compact fluorescent lamps. Complete with opal white PMMA diffuser and electronic ballast 50/60Hz 230/240V. Body and super-slim 18 mm width frame in painted or chromed metal. It can be completed with painted metal box for ceiling installation. It can also be installed in concrete or brick walls through specific galvanized steel wall-box, available as an accessory. Degree of protection IP43.

Lámpara empotrable para la iluminación difusa de techo, completa con fuente de iluminación lineal LED 220V y para lámparas fluorescentes compactas TC-TEL GX24 q 3-4. Completo con difusor PMMA opal blanco y reactancia electrónica 50/60Hz 230/240V. Cuerpo y marco super-slim 18 mm de ancho. En metal pintado o cromado. Se puede instalar también con caja de metal pintado para instalación en el techo y suspensión y pared de hormigón, usando una caja en lamina de zinc o de aluminio, disponible como accesorio. Grado de protección IP43.

---



CAFFETERIA MORCIANO IMOLA - ITALY  
PHOTO AD

## INCAS 1F

162X162



	W	mA	K	lm product	lm/Led	CRI	A	Kg	CODE	Col.	
LED 6,2W 16,0-19,6V CRI>90 16V <b>A+</b>	12,4	350	3000	826	1400	>90	<b>3.4</b>	1,8	<b>IN001.930</b>	<b>01 03 12</b>	
	12,4	350	4000	873	1480	>90	<b>3.4</b>	1,8	<b>IN001.940</b>	<b>01 03 12</b>	

Da completare con alimentatore remoto -To be completed with remote driver - A completar con alimentador remoto

	W		Dalit&D	Kg	CODE	Col.	
TC-TEL GX24-α3-4 230V <b>A→B</b>	1x26/32/42			1,8	<b>IN11F</b>	<b>01 03 12</b>	
	1x26/32/42		x	1,8	<b>IN11FD</b>	<b>01 03 12</b>	

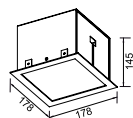

accessori - accessories- accesorios pag.520

## INCAS 2F

316X162



	W	mA	K	lm product	lm/Led	CRI	A	Kg	CODE	Col.	
LED 6,2W 16,0-19,6V CRI>90 <b>A+</b>	22,8	350	3000	1522	2580	>90	<b>3.4</b>	2,7	<b>IN002.930</b>	<b>01 03 12</b>	
	22,8	350	4000	1593	2700	>90	<b>3.4</b>	2,7	<b>IN002.940</b>	<b>01 03 12</b>	

Da completare con alimentatore remoto -To be completed with remote driver - A completar con alimentador remoto

	W		Dalit&D	Kg	CODE	Col.	
TC-TEL GX24-α3-4 230V <b>A→B</b>	26/32/42			2,7	<b>IN12F</b>	<b>01 03 12</b>	
	26/32/42		x	2,7	<b>IN12FD</b>	<b>01 03 12</b>	

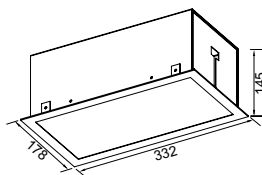

accessori - accessories- accesorios pag.520

01 - bianco - white - blanco

03 - cromo - chrome - cromo

12 - grigio - grey - gris

pag.824

**A** pag.820

## INCAS 3F

470X162



	W	K	lm product	lm/Led	CRI	A	Kg	CODE	Col.	
LED 6,2W 16,0-19,6V CRI>90	35,2	3000	2348	3980	>90	3.4	4,2	IN003.930	01 03 12	
	35,2	4000	2466	4180	>90	3.4	4,2	IN003.940	01 03 12	

Da completare con alimentatore remoto -To be completed with remote driver - A completar con alimentador remoto

	W	DaliT&D	Kg	CODE	Col.	
TC-TEL GX24-g3-4 230V	2x26/32/42		4,2	IN13F	01 03 12	
	2x26/32/42	x	4,2	IN13FD	01 03 12	

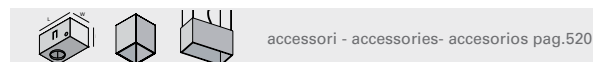
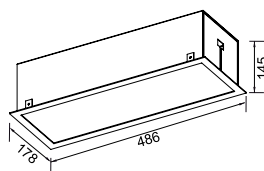

## INCAS 4F

316x316



	W	K	lm product	lm/Led	CRI	A	Kg	CODE	Col.	
LINEAR LED 24W/MT CRI>80	25,6	3000	1990	2464	>80	7.3	4,4	IN004.830	01 03 12	
	25,6	4000	2090	2560	>80	7.3	4,4	IN004.840	01 03 12	

Da completare con alimentatore remoto -To be completed with remote driver - A completar con alimentador remoto

	W	DaliT&D	Kg	CODE	Col.	
TC-TEL GX24-g3-4 230V	2x26/32/42		4,4	IN14F	01 03 12	
	2x26/32/42	x	4,4	IN14FD	01 03 12	

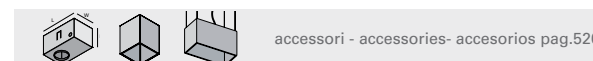
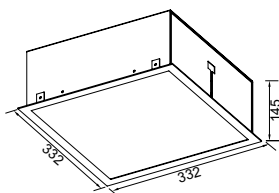

01 - bianco - white - blanco

03 - cromo - chrome - cromo

12 - grigio - grey - gris

pag.824

**A** pag.820



## CASSAFORMA DA MURARE INCAS SPOT E INCAS DIFFUSED

WALLBOX - CAJA

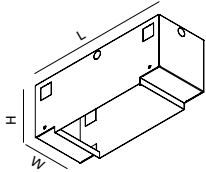

INCAS1A - 1F  
INCAS2A - 2F  
INCAS3A - 3F  
INCAS4A - 4F

Dim.	H
170x314	190
170x464	190
170x614	190
340X464	190

CODE
CC1A
CC2A
CC3A
CC4A

CASSAFORMA IN LAMIERA ZINCATO PER INSTALLAZIONE IN LATERIZIO O CALCESTRUZZO - GALVANIZED METAL WALLBOX FOR INSTALLING IN BRICK OR REINFORCED CONCRETE - CAJA DE METAL GALVANIZADO PARA INSTALAR EN LADRILLO O DE HORMIGÓN ARMADO

## CASSA DA PLAFONE O SOSPENSIONE INCAS SPOT E INCAS DIFFUSED

SURFACE MOUNTED OR SUSPENDED BOX - CAJA PARA TECHO Y SUSPENSION



INCAS1A - 1F soffitto - surface-techo

Dim.	H	Kg
178x178	220	2

COD.	COL.
CS.P1	01 12

CASSA IN METALLO PER INSTALLAZIONE INCAS 1X A PLAFONE O A SOSPENSIONE - METAL BOX FOR INSTALLING INCAS 1X SURFACE-MOUNTED OR SUSPENDED - CAJA DE METAL PARA LA INSTALACIÓN INCAS 1X TECHO Y SUSPENSION



INCAS2A - 2F soffitto - surface-techo  
INCAS2A - 2F sospensione - suspension - suspensión

Dim.	H	Kg
332 X 178	220	3,3
332 X 178	220 + 2000	3,4

COD.	COL.
CS.P2	01 12
CS.S2	01 12

CASSA IN METALLO PER INSTALLAZIONE INCAS 2X A PLAFONE O A SOSPENSIONE - METAL BOX FOR INSTALLING INCAS 2X SURFACE-MOUNTED OR SUSPENDED - CAJA DE METAL PARA LA INSTALACIÓN INCAS 2X TECHO Y SUSPENSION



INCAS3A - 3F soffitto - surface-techo  
INCAS3A - 3F sospensione - suspension - suspension

Dim.	H	Kg
486 X 178	220	4,6
489 X 178	220 + 2000	4,7

COD.	COL.
CS.P3	01 12
CS.S3	01 12

CASSA IN METALLO PER INSTALLAZIONE INCAS 3X A PLAFONE O A SOSPENSIONE - METAL BOX FOR INSTALLING INCAS 3X SURFACE-MOUNTED OR SUSPENDED - CAJA DE METAL PARA LA INSTALACIÓN INCAS 3X TECHO Y SUSPENSION



INCAS4A - 4F soffitto - surface-techo  
INCAS4A - 4F sospensione - suspension - suspension

Dim.	H	Kg
332 X 332	220	5,9
332 X 332	220 + 2000	4,6

COD.	COL.
CS.P4	01 12
CS.S4	01 12

CASSA IN METALLO PER INSTALLAZIONE INCAS 4X A PLAFONE O A SOSPENSIONE - METAL BOX FOR INSTALLING INCAS 4X SURFACE-MOUNTED OR SUSPENDED - CAJA DE METAL PARA LA INSTALACIÓN INCAS 4X TECHO Y SUSPENSION

01 - bianco - white - blanco

12 - grigio - grey - gris

## CASSAFORMA DA MURARE INCAS MINIMAL

WALLBOX - CAJA

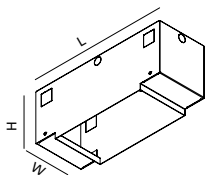

INCAS1 AM  
INCAS2 AM  
INCAS3 AM  
INCAS4 AM

Dim.	H
163x303	190
163x458	190
163x613	190
316x458	190

CODE  
**CC1AM**  
**CC2AM**  
**CC3AM**  
**CC4AM**

CASSAFORMA IN LAMIERA ZINCATO PER INSTALLAZIONE IN LATERIZIO O CALCESTRUZZO - GALVANIZED METAL WALLBOX FOR INSTALLING IN BRICK OR REINFORCED CONCRETE - CAJA DE METAL GALVANIZADO PARA INSTALAR EN LADRILLO O DE HORMIGÓN ARMADO

## TELAIO INCAS SPOT MINIMAL ISPEZIONABILE PER CARTONGESSO

PLASTERBOARD FRAME- MARCO POR CARTÓN YESO

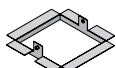

INCAS 1AM

162X163

CODE  
**TEIN01M**

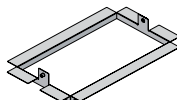

INCAS 2AM

316x163

CODE  
**TEIN02M**

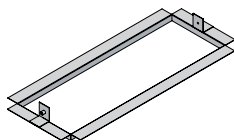

INCAS 3AM

470x163

CODE  
**TEIN03M**

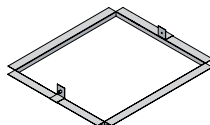

INCAS 4AM

316x316

CODE  
**TEIN04M**



TELAIO ISPEZIONABILE DA FISSARE E STUCCARE NEL CARTONGESSO DA 15MM. PER CARTONGESSI DA 13MM SPESSORARE - INSPECTABLE FRAME TO BE FIXED AND PLASTERED IN 15MM HEIGHT PLASTERBOARD FALSE CEILINGS - MARCO INSPECCIONABLE PARA FIJAR Y RELLENAR EN EL CARTÓN YESO DE 15 MM. PARA LAS PLANCHAS DE 13 MM SE RECOMIENDA CUÑA

## INCAS COPPIA DI STAFFE INCAS SPOT MINIMAL

COUPLE OF BRACKETS - PAREJA DE SOPORTES

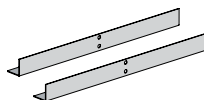

INCAS 1AM  
INCAS 2AM  
INCAS 3AM  
INCAS 4AM

Dim.	H
155x158	
463x158	
311x158	
617x158	

CODE  
**ST1**  
**ST2**  
**ST1**  
**ST2**

COPPIA DI STAFFE IN ALLUMINIO PER FISSARE E STUCCARE L'INCASSO NEL CARTONGESSO. SUGGERITE IN PRESENZA DI BOTOLA - COUPLE OF BRACKETS FOR PLASTERBOARD TO BE FIT AND PLASTER IN PLASTERBOARD ONLY IN CASE OF CEILINGS PROVIDED WITH TRAP DOOR INSPECTABLE. - PAREJA DE SOPORTES EN ALUMINIO CON LOS QUE SE FIJA EL APARATO AL CARTÓN YESO O SEPARADO. ACONSEJADOS EN CASO DE FALSO TECHO CON ACCESO PARA LA INSPECCIÓN, A TRAVÉS DEL CUAL ES POSIBLE EFECTUAR LA MANUTENCIÓN DE LOS ALIMENTADORES.



**CENTRO COMMERCIALE "CONÈ" CONEGLIANO VENETO - ITALY**  
**PROJECT ARCH. K.MAGGI - DIFFUSIONE LUCE**  
**PHOTO: FLORES**



---

Proiettore da incasso a parete e soffitto, dotato di monocolo telescopico estraibile e orientabile, per sorgente LED integrata o per lampade alogene/LED QR-CB 51 GU5,3 12V/230V, QPAR16 GU10. Corpo in metallo verniciato. Monocolo telescopico e cornice di battuta super-slim larghezza 10 mm. in metallo verniciato o cromato. Disponibile con cornice di battuta o a scomparsa totale trimless. Gruppo ottico estraibile 40 mm., orientabile di 355° sull'asse orizzontale e  $\pm 20/45^\circ$  su quello verticale. Alimentazione remota disponibile come accessorio. Installabile anche in pareti e soffitti in calcestruzzo mediante apposita cassaforma in lamiera zincata disponibile come accessorio. Grado di protezione IP20.

Recessed spotlight for wall and ceiling installation, with extractable and adjustable monocol, for integrated LED source or for QR-CB 51 GU5,3 12V/230V, QPAR16 GU10 halogen/LED lamps. Available in version with frame or trimless. Body in painted metal. Telescopic monocol and super-slim 10 mm width frame in painted or chromed metal. Optic group extractable 40 mm, adjustable 355° horizontally and  $\pm 20/45^\circ$  vertically. Remote power-supply available as an accessory. It can also be installed in concrete or brick walls through specific galvanized steel wall-box, available as an accessory. Degree of protection IP20.

Lamparas emportable por la pared y el techo, con monocolo telescopico extraible y adjustable para LED integrado o halogeno/LED QR-CB 51 GU5,3 12V/230V, QPAR16 GU10. Disponible en version con o sin marco. Cuerpo en metal pintado. Monocolo telescopico y marco super-slim 10 mm de ancho. En metal pintado o cromado. Grupo optico extraible 40 mm, adjustable 355° horizontal y  $\pm 20/45^\circ$  verticalmente. Reactancia remota disponible como accesorio. Tambien puede ser instalado en paredes y techos de hormigon usando una caja en lamina de zinc, disponible como accesorio. Grado de proteccion IP20.

---



## MINI INCAS



ESTRAIBILE +/- 40 mm  
EXTRACTABLE +/- 40 mm



ORIENTABILE 355° sull'asse verticale e +/- 45° su quello orizzontale  
DIRECTIONAL 355° vertically and +/- 45° horizontally



UN JOUR À PEYRASSOL - BELGIUM  
INTERIOR DESIGN BY PINTO & CO  
LIGHTING CONCEPT BY PINTO & CO IN COLLABORATION WITH HUGO NEUMANN (C)







ABITAZIONE PRIVATA ANDRIA - ITALY  
PROJECT STUDIO TECNICO ARCHITETTURA & INGEGNERIA ING. G. SELLITRI  
PHOTO SELLITRI

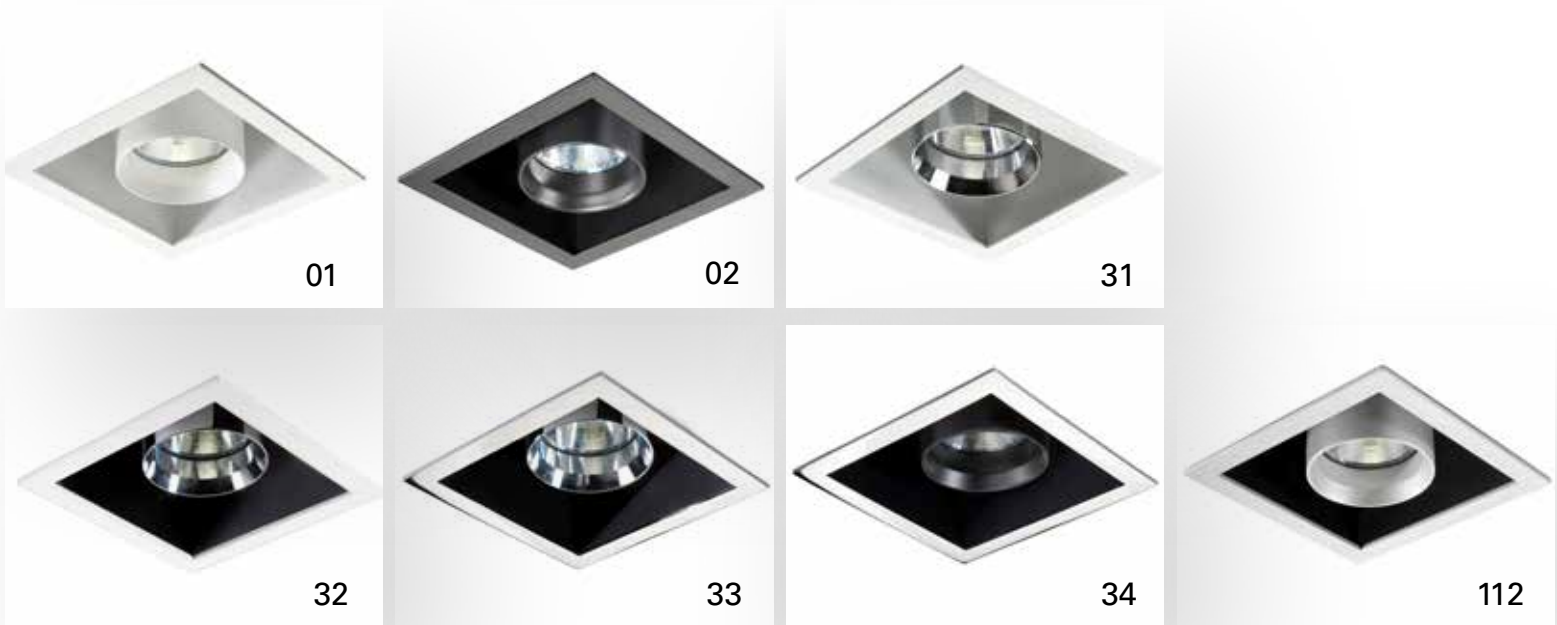

01 BIANCO - WHITE - BLANCO

02 NERO - BLACK - NEGRO

31 CASSA BIANCA - CORNICE BIANCA - ANELLI CROMO - WHITE BOX - WHITE FRAME - CHROME RINGS - CAJA BLANCA - MARCO BLANCA - ANILLAS CROMO

32 CASSA NERA - CORNICE BIANCA - ANELLI CROMO - BLACK BOX - WHITE FRAME - CHROME RINGS - CAJA NEGRA - MARCO BLANCA - ANILLAS CROMO

33 CASSA NERA - CORNICE CROMO - ANELLO CROMO - BLACK BOX - CHROME FRAME - CHROME RING - CAJA NEGRA - MARCO CROMO - ANILLAS CROMO

34 CASSA NERA - CORNICE CROMO - ANELLO NERO - BLACK BOX - CHROME FRAME - BLACK RING - CAJA NEGRA - MARCO CROMO - ANILLAS BLACK

112 CASSA NERA - CORNICE GRIGIA - ANELLI GRIGI - BLACK BOX - GREY FRAME - GREY RINGS - CAJA NEGRA - MARCO GRIS - ANILLAS GRIS

## MINI INCAS 1

102X102



LED	W	mA	K	lm product	lm/Led	CRI	∠	A	Dim.	H	α	Kg	CODE	Col.
3SDCM 50000h L90 B10 ta 25°C	11	350	2700	931	1100	>90	29°	3.2	110x110	135	20	0,60	LT1250.927S	01 02 31 32 33 34 112
	11	350	2700	703	1100	>90	42°	3.2	110x110	135	20	0,60	LT1250.927F	01 02 31 32 33 34 112
	11	350	3000	1003	1185	>90	29°	3.2	110x110	135	20	0,60	LT1250.930S	01 02 31 32 33 34 112
	11	350	3000	757	1185	>90	42°	3.2	110x110	135	20	0,60	LT1250.930F	01 02 31 32 33 34 112
	11	350	4000	1088	1285	>90	29°	3.2	110x110	135	20	0,60	LT1250.940S	01 02 31 32 33 34 112
	11	350	4000	821	1285	>90	42°	3.2	110x110	135	20	0,60	LT1250.940F	01 02 31 32 33 34 112

QR-CB51 GU5,3 12V	W	A	Dim.	H	α	Kg	CODE	Col.	
A+-D	1x max 50		T.1	110x110	135	45	0,58	LT1204	01 02 31 32 33 34 112

QPAR16 GU10 230V	W	Dim.	H	α	Kg	CODE	Col.
A+-D	1x max 50	110x110	135	45	0,62	LT1205	01 02 31 32 33 34 112

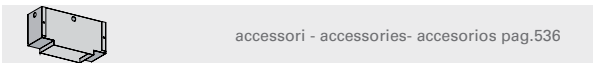
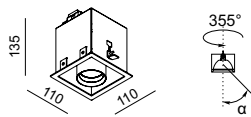

## MINI INCAS 2

194X102



LED	W	mA	K	lm product	lm/Led	CRI	∠	A	Dim.	H	α	CODE	Col.
3SDCM 50000h L90 B10 ta 25°C	2x11	350	2700	1862	2200	>90	29°	3.2	110x206	135	20	LT1254.927S	01 02 31 32 33 34 112
	2x11	350	2700	1405	2200	>90	42°	3.2	110x206	135	20	LT1254.927F	01 02 31 32 33 34 112
	2x11	350	3000	2006	2370	>90	29°	3.2	110x206	135	20	LT1254.930S	01 02 31 32 33 34 112
	2x11	350	3000	1514	2370	>90	42°	3.2	110x206	135	20	LT1254.930F	01 02 31 32 33 34 112
	2x11	350	4000	2175	2570	>90	29°	3.2	110x206	135	20	LT1254.940S	01 02 31 32 33 34 112
	2x11	350	4000	1642	2570	>90	42°	3.2	110x206	135	20	LT1254.940F	01 02 31 32 33 34 112

QR-CB51 GU5,3 12V	W	A	Dim.	H	α	CODE	Col.	
A+-D	2x max 50		T.1	110x206	135	45	LT1211	01 02 31 32 33 34 112

QPAR16 GU10 230V	W	Dim.	H	α	CODE	Col.
A+-D	2x max 50	110x206	135	45	LT1212	01 02 31 32 33 34 112

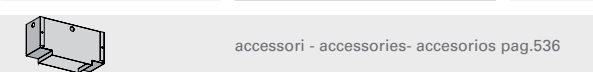
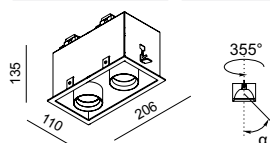



# MINI INCAS 3

290X102



LED	W	mA	K	lm product	lm/Led	CRI	∠	A	Dim.	H	α	CODE	Col.	
3SDCM 50000h L90 B10 ta 25°C	3x11	350	2700	2793	3300	>90	29°	3.2	110x302	135	20	LT1258.927S	01 02 31 32 33 34 112	
	3x11	350	2700	2108	3300	>90	42°	3.2	110x302	135	20	LT1258.927F	01 02 31 32 33 34 112	
	3x11	350	3000	3009	3555	>90	29°	3.2	110x302	135	20	LT1258.930S	01 02 31 32 33 34 112	
	3x11	350	3000	2271	3555	>90	42°	3.2	110x302	135	20	LT1258.930F	01 02 31 32 33 34 112	
	3x11	350	4000	3263	3855	>90	29°	3.2	110x302	135	20	LT1258.940S	01 02 31 32 33 34 112	
	3x11	350	4000	2463	3855	>90	42°	3.2	110x302	135	20	LT1258.940F	01 02 31 32 33 34 112	
QR-CB51 GU5,3 12V	3x max 50							T.1	110x302	135	45	LT1219	01 02 31 32 33 34 112	
QPAR16 GU10 230V	3x max 50								110x302	135	45	LT1220	01 02 31 32 33 34 112	

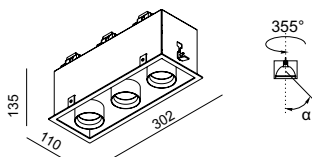

accessori - accessories- accesorios pag.536

# MINI INCAS 4

198X192



LED	W	mA	K	lm product	lm/Led	CRI	∠	A	Dim.	H	α	CODE	Col.	
3SDCM 50000h L90 B10 ta 25°C	4x11	350	2700	3724	4400	>90	29°	3.2	206x206	135	20	LT1262.927S	01 02 31 32 33 34 112	
	4x11	350	2700	2811	4400	>90	42°	3.2	206x206	135	20	LT1262.927F	01 02 31 32 33 34 112	
	4x11	350	3000	4012	4740	>90	29°	3.2	206x206	135	20	LT1262.930S	01 02 31 32 33 34 112	
	4x11	350	3000	3028	4740	>90	42°	3.2	206x206	135	20	LT1262.930F	01 02 31 32 33 34 112	
	4x11	350	4000	4350	5140	>90	29°	3.2	206x206	135	20	LT1262.940S	01 02 31 32 33 34 112	
	4x11	350	4000	3283	5140	>90	42°	3.2	206x206	135	20	LT1262.940F	01 02 31 32 33 34 112	
QR-CB51 GU5,3 12V	4x max 50							T.1	206x206	135	45	LT1227	01 02 31 32 33 34 112	
QPAR16 GU10 230V	4x max 50								206x206	135	45	LT1228	01 02 31 32 33 34 112	

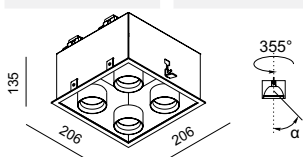

accessori - accessories- accesorios pag.536



**MINI INCAS MINIMAL**

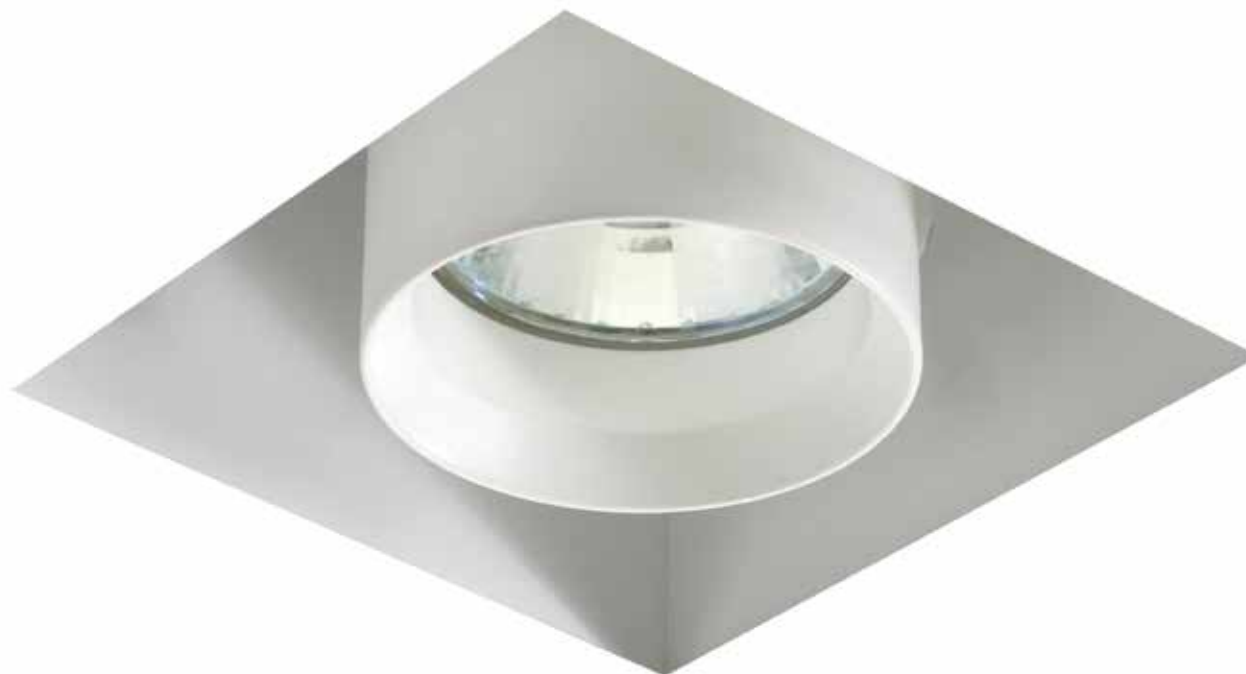

**ESTRAIBILE +/- 40 mm**  
EXTRACTABLE +/- 40 mm



**ORIENTABILE 355° sull'asse verticale e +/- 45° su quello orizzontale**  
DIRECTIONAL 355° vertically and +/- 45° horizontally



## MINI INCAS 1M

96X96



	W	mA	K	lm product	lm/Led	CRI	△	A	Dim.	H	α	CODE	Col.	
LED 3SDCM 50000h L90 B10 ta 25°C <b>A+</b>	11	350	2700	931	1100	>90	29°	3.2	96x96	135	20	LT1266.927S	01 02 31 32 112	    
	11	350	2700	703	1100	>90	42°	3.2	96x96	135	20	LT1266.927F	01 02 31 32 112	
	11	350	3000	1003	1185	>90	29°	3.2	96x96	135	20	LT1266.930S	01 02 31 32 112	
	11	350	3000	757	1185	>90	42°	3.2	96x96	135	20	LT1266.930F	01 02 31 32 112	
	11	350	4000	1088	1285	>90	29°	3.2	96x96	135	20	LT1266.940S	01 02 31 32 112	
	11	350	4000	821	1285	>90	42°	3.2	96x96	135	20	LT1266.940F	01 02 31 32 112	
QR-CB51 GU5,3 12V <b>A+-D</b>	1x max 50							T.1	96x96	135	45	LT1201	01 02 31 32 112	  
QPAR16 GU10 230V <b>A+-D</b>	1x max 50								96x96	135	45	LT1202	01 02 31 32 112	

Da completare con telaio per controsoffitto o cassaforma per cemento/laterizio | To be completed with frame for false ceiling or wallbox brick/concrete | A completar con marco o el techo encofrado para hormigón / ladrillo

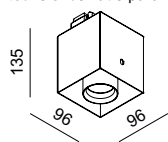

accessori - accessories- accesorios pag.537

## MINI INCAS 2M

192X96



	W	mA	K	lm product	lm/Led	CRI	△	A	Dim.	H	α	CODE	Col.	
LED 3SDCM 50000h L90 B10 ta 25°C <b>A+</b>	2x11	350	2700	1862	2200	>90	29°	3.2	96x192	135	20	LT1270.927S	01 02 31 32 112	    
	2x11	350	2700	1405	2200	>90	42°	3.2	96x192	135	20	LT1270.927F	01 02 31 32 112	
	2x11	350	3000	2006	2370	>90	29°	3.2	96x192	135	20	LT1270.930S	01 02 31 32 112	
	2x11	350	3000	1514	2370	>90	42°	3.2	96x192	135	20	LT1270.930F	01 02 31 32 112	
	2x11	350	4000	2175	2570	>90	29°	3.2	96x192	135	20	LT1270.940S	01 02 31 32 112	
	2x11	350	4000	1642	2570	>90	42°	3.2	96x192	135	20	LT1270.940F	01 02 31 32 112	
QR-CB51 GU5,3 12V <b>A+-D</b>	2x max 50							T.1	96x192	135	45	LT1207	01 02 31 32 112	  
QPAR16 GU10 230V <b>A+-D</b>	2x max 50								96x192	135	45	LT1208	01 02 31 32 112	 

Da completare con telaio per controsoffitto o cassaforma per cemento/laterizio | To be completed with frame for false ceiling or wallbox brick/concrete - | A completar con marco o el techo encofrado para hormigón / ladrillo

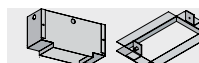
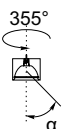
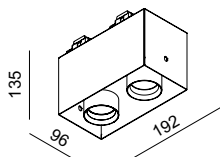

accessori - accessories- accesorios pag.537

## MINI INCAS 3M

288X56



	W	mA	K	lm product	lm/Led	CRI	∠	A	Dim.	H	α	CODE	Col.	
LED 3SDCM 50000h L90 B10 ta 25°C <b>A+</b>	3x11	350	2700	2793	3300	>90	29°	3.2	96x288	135	20	LT1274.927S	01 02 31 32 112	
	3x11	350	2700	2108	3300	>90	42°	3.2	96x288	135	20	LT1274.927F	01 02 31 32 112	
	3x11	350	3000	3009	3555	>90	29°	3.2	96x288	135	20	LT1274.930S	01 02 31 32 112	
	3x11	350	3000	2271	3555	>90	42°	3.2	96x288	135	20	LT1274.930F	01 02 31 32 112	
	3x11	350	4000	3263	3855	>90	29°	3.2	96x288	135	20	LT1274.940S	01 02 31 32 112	
	3x11	350	4000	2463	3855	>90	42°	3.2	96x288	135	20	LT1274.940F	01 02 31 32 112	
QR-CB51 GU5,3 12V <b>A+-D</b>	3x max 50							T.1	96x288	135	45	LT1215	01 02 31 32 112	
QPAR16 GU10 230V <b>A+-D</b>	3x max 50								96x288	135	45	LT1216	01 02 31 32 112	

Da completare con telaio per controsoffitto o cassaforma per cemento/laterizio | To be completed with frame for false ceiling or wallbox brick/concrete | A completar con marco o el techo encofrado para hormigón / ladrillo

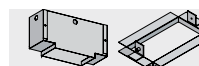
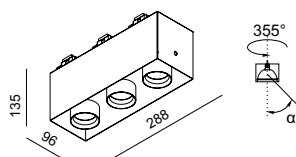

accessori - accessories- accesorios pag.537

## MINI INCAS 4M

192X192



	W	mA	K	lm product	lm/Led	CRI	∠	A	Dim.	H	α	CODE	Col.	
LED 3SDCM 50000h L90 B10 ta 25°C <b>A+</b>	4x11	350	2700	931	1100	>90	29°	3.2	192x192	135	20	LT1279.927S	01 02 31 32 112	
	4x11	350	2700	703	1100	>90	42°	3.2	192x192	135	20	LT1279.927F	01 02 31 32 112	
	4x11	350	3000	1003	1185	>90	29°	3.2	192x192	135	20	LT1279.930S	01 02 31 32 112	
	4x11	350	3000	757	1185	>90	42°	3.2	192x192	135	20	LT1279.930F	01 02 31 32 112	
	4x11	350	4000	1088	1285	>90	29°	3.2	192x192	135	20	LT1279.940S	01 02 31 32 112	
	4x11	350	4000	821	1285	>90	42°	3.2	192x192	135	20	LT1279.940F	01 02 31 32 112	
QR-CB51 GU5,3 12V <b>A+-D</b>	4x max 50							T.1	192x192	135	45	LT1223	01 02 31 32 112	
QPAR16 GU10 230V <b>A+-D</b>	4x max 50								192x192	135	45	LT1224	01 02 31 32 112	

Da completare con telaio per controsoffitto o cassaforma per cemento/laterizio - | To be completed with frame for false ceiling or wallbox brick/concrete | A completar con marco o el techo encofrado para hormigón / ladrillo

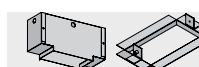
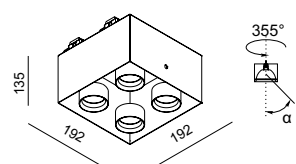

accessori - accessories- accesorios pag.537

## CASSAFORMA MINI INCAS

WALLBOX MINI INCAS - CAJA MINI INCAS

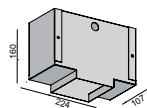

MINI INCAS 1

Dim. H  
107x224 160

CODE  
**LT1191**

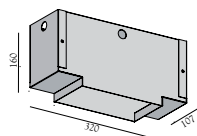

MINI INCAS2

Dim. H  
107x320 160

CODE  
**LT1192**

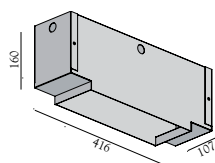

MINI INCAS3

Dim. H  
107x416 160

CODE  
**LT1193**

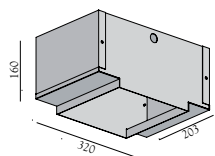

MINI INCAS4

Dim. H  
203x320 160

CODE  
**LT1194**

CASSAFORMA IN LAMIERA ZINCATA PER INSTALLAZIONE IN LATERIZIO O CALCESTRUZZO - GALVANIZED METAL WALLBOX FOR INSTALLING IN BRICK OR REINFORCED CONCRETE - CAJA DE METAL GALVANIZADO PARA INSTALAR EN LADRILLO O DE HORMIGÓN ARMADO

## CASSAFORMA MINI INCAS M

WALLBOX MINI INCAS M- CAJA MINI INCAS M

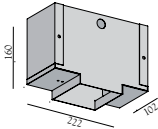
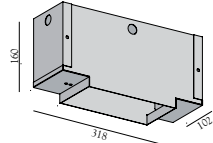
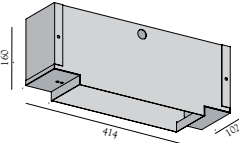
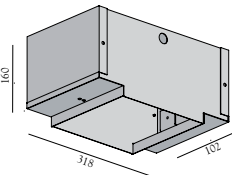
	MINI INCAS 1M	Dim. 102x222	H 160	CODE LT1195	CE
	MINI INCAS 2M	Dim. 102x318	H 160	CODE LT1196	CE
	MINI INCAS 3M	Dim. 102x414	H 160	CODE LT1197	CE
	MINI INCAS 4M	Dim. 198x318	H 160	CODE LT1198	CE

CASSAFORMA IN LAMIERA ZINCATO PER INSTALLAZIONE IN LATERIZIO O CALCESTRUZZO - GALVANIZED METAL WALLBOX FOR INSTALLING IN BRICK OR REINFORCED CONCRETE - CAJA DE METAL GALVANIZADO PARA INSTALAR EN LADRILLO O DE HORMIGÓN ARMADO

## TELAIO MINI INCAS M

FRAME FOR MINI INCAS M- SOPORTE POR MINI INCAS M

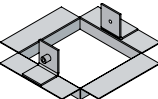
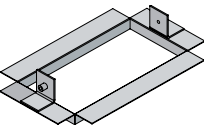
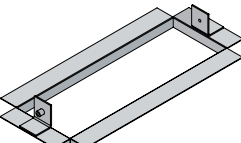
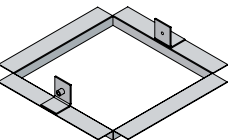
	MINI INCAS 1M	Dim. 100x100	CODE LT1231	CE
	MINI INCAS 2M	Dim. 100x196	CODE LT1232	CE
	MINI INCAS 3M	Dim. 100x292	CODE LT1233	CE
	MINI INCAS 4M	Dim. 196x196	CODE LT1234	CE

TELAIO ISPEZIONABILE DA FISSARE E STUCCARE NEL CARTONGESSO DA 15MM. PER CARTONGESSI DA 13MM SPESSORARE - INSPECTABLE FRAME TO BE FIXED AND PLASTERED IN 15MM HEIGHT PLASTERBOARD FALSE CEILINGS - INSPECCIÓN MARCO PARA FIJAR Y RELLENAR EL CARTÓN YESO DE 15 MM. PARA LAS PLANCHAS DE 13 MM SE RECOMIENDA CUÑA

Apparecchio da incasso a parete e soffitto, fisso per sorgente LED integrata o per lampade alogene/LED QR-CB 35, QR-CB 51, QR-LP 111 12V/230V , QPAR16 e a ioduri metallici HIR-CE 111 230V/240V. Alimentazione remota disponibile come accessorio. Corpo e cornice di battuta super-slim larghezza 5 mm. in metallo verniciato. Installabile anche in pareti e soffitti in calcestruzzo mediante apposita cassaforma in lamiera zincata disponibile come accessorio. Grado di protezione IP20/IP23.

Recessed downlight for wall and ceiling installation, for integrated LED source or for halogen/LED QR-CB 35, QR-CB 51, QR-LP 111 12V/230V and QPAR16 or metal halide HIR-CE 111 230V/240V lamps. Remote power-supply available as an accessory. Body and super-slim 5 mm width frame in painted metal. It can also be installed in concrete or brick walls through specific galvanized steel wall-box, available as an accessory. Degree of protection IP20/IP23.

Lámpara empotrable fija para pared y techo, para LED integrado o halógeno/LED QR-CB35, QR-CB51, QR-LP111 12V/230V, QPAR16 y halogenuros metálicos HIR-CE 111 230V/240V. Reactancia remota disponible como accesorio. Cuerpo y marco super-slim 5 mm de ancho en metal pintado. También puede ser instalada en paredes y techos de hormigón usando una caja en lámina de zinc, disponible como accesorio. Grado de protección IP20/IP23.

---

**MINIFRAME**



## MINIFRAME 35

52X52



LED	W	mA	K	lm product	lm/Led	CRI	∠
50000h L90 B10 ta 25°C	5	500	3000	310	395	95	22°

QR-CB35 GU4 12V	W
	1 x max 35

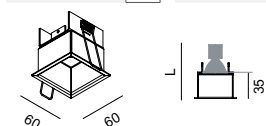

A	CODE	Col.
5.1	LT4102.930S	01 02



A	CODE	Col.
1.1	LT4101	01 02



accessori - accessories- accesorios pag.542

## MINIFRAME 50

72X72



LED	W	mA	K	lm product	lm/Led	CRI	∠
3SDCM 50000h L90 B10 ta 25°C	6,8	350	3000	330	494	>90	24°
	6,8	350	3000	450	494	>90	36°
	11	350	2700	931	1100	>90	29°
	11	350	2700	703	1100	>90	42°
	11	350	3000	1003	1185	>90	29°
	11	350	3000	757	1185	>90	42°
	11	350	4000	1088	1285	>90	29°
	11	350	4000	821	1285	>90	42°

QR-CB51 GU5,3 12V	W
	1 x max 50

OPAR16 GU10 230V	W
	1 x max 50

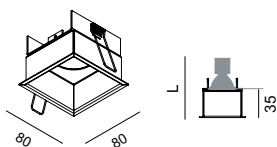

A	Lmm	CODE	Col.
3.1	125	LT4106A	01 02
3.1	125	LT4106B	01 02
3.2	125	LT4106.927S	01 02
3.2	125	LT4106.927F	01 02
3.2	125	LT4106.930S	01 02
3.2	125	LT4106.930F	01 02
3.2	125	LT4106.940S	01 02
3.2	125	LT4106.940F	01 02



A	Dim.	Lmm	CODE	Col.
1.1	80x80	35+lampadina	LT4103	01 02



Dim.	Lmm	CODE	Col.
80x80	35+lampadina	LT4104	01 02



accessori - accessories- accesorios pag.542

01 - bianco - white - blanco    02 - nero - black - negro

pag.824

pag.820



# MINIFRAME 111

118X118



LED	W	mA	K	lm product	lm/Led	CRI	∠	A	Dim.	CODE	Col.
3SDCM 50000h L90 B10 ta 25°C	24,3	700	3000	2045	2545	95	16°	7.3	130x130	LT4109A	01 02
	375	1050	3000	2731	3785	95		10.1			
	24,3	700	4000	2250	2800	95	16°	7.3	130x130	LT4109B	01 02
	375	1050	4000	2998	4155	95		10.1			
	24,3	700	3000	2160	2545	95	25°	7.3	130x130	LT4109C	01 02
	375	1050	3000	2886	3785	95		10.1			
	24,3	700	4000	2376	2800	95	25°	7.3	130x130	LT4109F	01 02
	375	1050	4000	3168	4155	95		10.1			
	24,3	700	3000	2250	2545	95	40°	7.3	130x130	LT4109G	01 02
	375	1050	3000	3020	3785	95		10.1			
	24,3	700	4000	2475	2800	95	40°	7.3	130x130	LT4109L	01 02
	375	1050	4000	3315	4155	95		10.1			

**WARNING:** Non installabile a cassaforma | Not to be installed in the formwork | No para ser instalado en el encofrado

QR-LP 111 G53 12V	W	A	CODE	Col.
1x max 60		1.2	LT4109	01 02

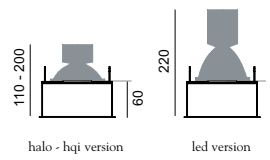
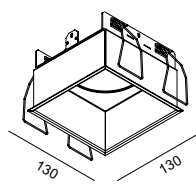

accessori - accessories- accesorios pag.542

DOWLIGHTERS

01 - bianco - white - blanco    02 - nero - black - negro

pag.824    **A** pag.820

## CASSAFORMA MINIFRAME 35

WALLBOX MINIFRAME 35 - CAJA MINIFRAME 35

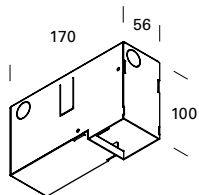

Dim. H  
170X56 100

CODE  
LT4101.CC



## CASSAFORMA MINIFRAME 50

WALLBOX MINIFRAME 50 - CAJA MINIFRAME 50

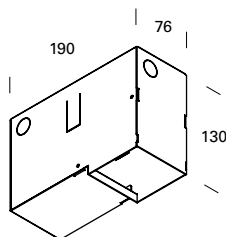

Dim. H  
190X76 130

CODE  
LT4102.CC



## CASSAFORMA MINIFRAME 111

WALLBOX MINIFRAME 111 - CAJA MINIFRAME 111

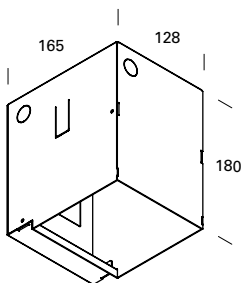

Dim. H  
165X128 180

CODE  
LT4109.CC



**WARNING** non utilizzabile con versioni LED | not suitable for LED version | non utilizar por la version LED



Apparecchio da incasso solo a soffitto, rasato a scomparsa totale trimless composto da un telaio da fissare, stuccare e rasare in cartongesso, corpo in metallo verniciato e schermo diffondente in PC opalino bianco, per illuminazione diffusa. Completo di sorgenti lineari LED o per lampade fluorescenti compatte completo di alimentazione elettronica 50/60Hz 230/240V. Grado di protezione IP43.

Trimless recessed downlight for installation in plasterboard false-ceiling (wall installation not allowed), made of a frame to fix and plaster into the false-ceiling, a painted metal box and a PC opal white diffuser, for diffused lighting. Complete with linear LED source or for GX24 q3/4TC-TEL compact fluorescent lamps complete with 50/60Hz 230/240V electronic ballast. IP43 degree of protection.



Aparato para empotrar sólo en techo, totalmente enrasado, trimless, con soporte para su instalación en cartón-yeso, cuerpo en metal barnizado y pantalla reflectora en PC opal blanco, para iluminación difusa. Con fuentes luminosas lineales LED o lámparas fluorescentes compactas, con alimentación electrónica 50/60Hz 230V/240V. con grupo de batería e inversor. Grado de protección IP43.

---





## HIDE SYSTEM

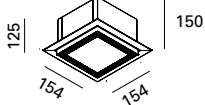





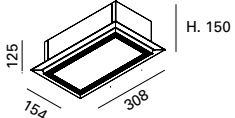

## HIDE SYSTEM 1

	W	mA	K	lm product	lm/Led	CRI	A	Dim.	H	Kg	CODE	
	LED 6,2W 16,0-19,6V CRI>90 16V			770	1400	>90	3.4	154x154	150	1,7	<b>HS001.930</b>	
				814	1480	>90		154x154	150	1,7		
Da completare con alimentatore remoto -To be completed with remote driver - A completar con alimentador remoto												
	TC-TEL GX24-o3-4 230V							Dim.	H	Kg	CODE	
	26/32/42							154x154	150	1,7	<b>HS001</b>	
												

## HIDE SYSTEM 2







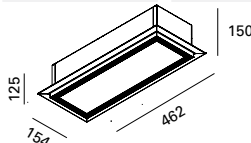

	W	mA	K	lm product	lm/Led	CRI	△	A	Dim.	H	Kg	CODE	
	LED 6,2W 16,0-19,6V CRI>90			1419	2580	>90		3.4	154x308	150	2,7	<b>HS002.930</b>	
				1485	2700	>90			154x308	150	2,7		
Da completare con alimentatore remoto -To be completed with remote driver - A completar con alimentador remoto													
	TC-TEL GX24-o3-4 230V								Dim.	H	Kg	CODE	
	26/32/42								154x308	150	2,7	<b>HS002</b>	
													

## HIDE SYSTEM 3

	W	mA	K	lm product	lm/Led	CRI	△	A	Dim.	H	Kg	CODE	
LED 6,2W 16,0-19,6V CRI>90 <b>A+</b>	35,2	350	3000	2189	3980	>90		<b>3.4</b>	154x462	150	4,2	<b>HS003.930</b>	   
	35,2	350	4000	2299	4180	>90		<b>3.4</b>	154x462	150	4,2	<b>HS003.940</b>	
Da completare con alimentatore remoto -To be completed with remote driver - A completar con alimentador remoto													
TC-TEL GX24-g3-4 230V <b>A-B</b>	W								Dim.	H	Kg	CODE	
	2x26/32/42								154x462	150	4,2	<b>HS003</b>	   



## HIDE SYSTEM 4

	W	mA	K	lm product	lm/Led	CRI	△	A	Dim.	H	Kg	CODE	
LINEAR LED 24W/MT 2200LM/MT CRI>80 50000h Ta 25° L70B10 <b>A+</b>	25,6	700	3000	1826	2464	>80		<b>7.3</b>	308x308	110	4,2	<b>HS004.930</b>	   
	25,6	700	4000	1290	2560	>80		<b>7.3</b>	308x308	110	4,2	<b>HS004.940</b>	
Da completare con alimentatore remoto -To be completed with remote driver - A completar con alimentador remoto													
TC-TEL GX24-g3-4 230V <b>A-B</b>	W								Dim.	H	Kg	CODE	
	2x26/32/42								308x308	110	4,2	<b>HS004</b>	   

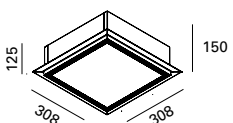





PARALLEL TOWER  
PROJECT ARCH. SNH ENGINEERING



## COPPIA PROFILI RETTILINEI COMPLETI DI GIUNTI LINEARI

COPPIA PROFILI RETTILINEI COMPLETI DI GIUNTI LINEARI - STRAIGHT ALUMINIUM COUPLE, LINEAR JOINT INCLUDED- PAREJA DE VIAS RECTO, PAREJA DE CONECTORES LINEARE INCLUIDO

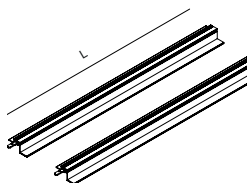

Lmm	CODE
500	LT2016HS
1000	LT2017HS
1500	LT2018HS
2000	LT2019HS
3000	LT2020HS
.....	LT20HS.misura*

Accessori non obbligatori. Necessari in caso di tagli in cantiere | Accessories not required. necessary in case of cuts on site. - Accesorios no necesarios | Accesorios no necesarios. necesaria en caso de corte en sitio de construcción

## COPPIA TESTATA TELAIO L. 138 MM

COPPIA TESTATA TELAIO L. 138 MM- COUPLE OF HEAD-FRAME MM138 WIDE- PAR DE TERMINALES L.138 MM

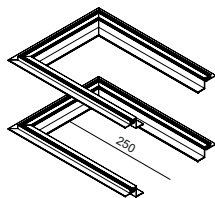

Lmm	CODE
138	LT2010HS

Una coppia di testate unite insieme formano una porzione di taglio da 500 mm | A couple of head-frame together is for a cut of 500 mm | Una pareja de cabezales juntos es para un corte de 138 mm

## COPPIA TESTATE TELAIO L. 68 MM

COPPIA TESTATE TELAIO L. 68 MM- OF HEAD-FRAME L. 68 MM GUIDE- PAR DE TERMINALES L. 68 MM

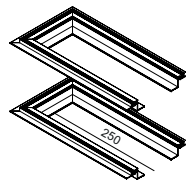

Lmm	CODE
68	LT2010HS.68

Una coppia di testate unite insieme formano una porzione di taglio da 500 mm | A couple of head-frame together is for a cut of 500 mm | Una pareja de cabezales juntos es para un corte de 500 mm

\*Tramite questo codice è possibile ordinare il profilo in una lunghezza lineare non standard. Sostituire alla parola "misura" la lunghezza desiderata in mm. Per profili oltre i 3 mt e massimo 6 mt le condizioni di trasporto sono da concordare. |

\*Through this code it's possible to order the profile in a not-standard linear length. Replace the word "misura" with the desired length in mm. For lengths over 3 mt. to max. 6 mt. transport conditions to negotiate. |

\*El uso de este código, se puede ordenar el perfil en un lineal longitud no estándar. Sustitúyase la palabra "medida" de la longitud en mm. Perfiles para más de 3 my 6 m Condiciones máximas de transporte a convenir.

## HIDE SYSTEM SISTEMA ANGOLO INTERNO 68/138 MM

ANGOLO INTERNO 68/138 MM- INTERIOR ANGLE 68/138 MM- ÀNGULO INTERIOR 68/138 MM



CODE  
LT2011HS

Completi di giunti lineari | linear joint included | pareja de conectores lineare incluido

## HIDE SYSTEM SISTEMA ANGOLO ESTERNO PER TAGLIO DA 68 MM

ANGOLO ESTERNO PER TAGLIO DA 68 MM- EXTERIOR ANGLE FOR 68 MM CUT- ÀNGULO EXTERIOR PARA CORTE DE 68 MM

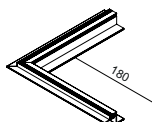

CODE  
LT2012HS.68

Einschließlich Vorschaltgerät | linear joint included | pareja de conectores lineare incluido

## HIDE SYSTEM SISTEMA GIUNTI D'ANGOLO COPPIA

GIUNTI D'ANGOLO COPPIA- ANGLE CONNECTOR COUPLE- CONECTORES ANGULARES PAREJA



CODE  
LT2014

Accessori non obbligatori. Necessari in caso di tagli in cantiere | Accessories not required. necessary in case of cuts on site | Accesorios no necesarios. necesaria en caso de corte en sitio de construcción

## HIDE SYSTEM SISTEMA COPPIA GIUNTI LINEARI

COPPIA GIUNTI LINEARI- STRAIGHT CONNECTOR COUPLE - PAREJA DE CONECTORES RECTOS



CODE  
LT2013

Accessori non obbligatori. Necessari in caso di tagli in cantiere | Accessories not required. necessary in case of cuts on site | Accesorios no necesarios. necesaria en caso de corte en sitio de construcción

## STRIP BOBINA DA 5 METRI

STRIP LED 5 METERS ROLL- BOBINA STRIP LED 5 METROS



	W/mt	V	Led/ mt	lm/mt	K	lm product	lm/W	CRI	IP	A	Lmm	Kg	CODE
LINEAR LED 24V  A+	5,5	24	60	270	3000	1350	245	80	20	V.1	5000	0,18	ST05.30.5
	9,6	24	120	540	3000	2700	281	80	20	V.1	5000	0,18	ST10.30.5
	11	24	180	1200	3000	6000	545	80	20	V.1	5000	0,18	ST11.30.5
	18	24	168	2200	3000	11000	611	80	20	V.1	5000	0,18	ST21.30.5
LINEAR LED IP65 24V  A+	9,6	24	120	540	3000	2700	281	80	65	V.1	5000	0,18	ST10.30.5IP
	14,4	24	60	900	3000	4500	313	80	65	V.1	5000	0,18	ST15.30.5IP
	19,2	24	240	1080	3000	5400	281	80	65	V.1	5000	0,18	ST20.30.5IP

Apparecchio da incasso fisso a parete e soffitto, per illuminazione direzionata o diffusa mediante impiego di vetro diffusore satinato disponibile come accessorio. Incidenza emissione luminosa 90° (Incas 90 e 90 Micro) o 45° (Incas 45 e 45 Micro). Per sorgente LED integrata o per lampade alogene/LED QR-CB 35 GU4 e QR-CB 51 GU5,3 12V/230V, QPAR16 GU10 e QT14 c G9 230V/240V. Alimentazione remota disponibile come accessorio. Corpo e cornice di battuta super-slim larghezza 19-12 mm in metallo verniciato o cromato. Installabile anche in pareti e soffitti in calcestruzzo mediante apposita cassaforma in lamiera zincata disponibile come accessorio. Grado di protezione IP20/IP23.

Recessed downlight for wall and ceiling installation, for accent lighting (or diffused, through a white frosted glass available as an accessory). Light emission incidence 90° (Incas 90 and 90 Micro) or 45° (Incas 45 and 45 Micro). Equipped for integrated LED source or for halogen/LED lamps QR-CB 35 GU4 and QR-CB 51 GU5,3 12V/230V or QPAR16 GU10 and QT14 c G9 230V/240V lamps. Remote power-supply available as AN accessory. Body and super-slim 19-12 mm width frame in painted or chromed metal. It can also be installed in concrete or brick walls through specific galvanized steel wall-box, available as an accessory. Degree of protection IP20/IP23.

Lampara emportable y fija por el techo y por una iluminacion extendida y difundido a traves del vidrio diffusor satinado disponible como accesorio. Emision de incidencia de la luz 90° (Incas 90 y 90 Micro) or 45° (Incas 45 y 45 Micro) Completo con LED integrado o para lampara halogena/LED QR-CB 35 GU4 y QR-CB-51 GU5,3 12V/230V, QPAR16 GU10 y QT14 c G9 230V/240V. Alimentacion remota disponible como accesorio. Cuerpo y marco super-slim 19-12 mm de ancho en metal pintado o cromado. Tambien puede ser instalado en paredes y techos de hormigon usando una caja en lamina de zinc, disponible como accesorio. Grado de proteccion IP20/IP23.



**INCAS 45-90**

## INCAS 45

92X90



	W	mA	K	lm product	lm/Led	CRI	△	A	CODE	Col.	
LED 50000h L90 B10 ta 25°C <b>A+</b>	5	500	3000	310	395	95	22°	<b>5.1</b>			CE, IP20, LED, A+
QR-CB51 GU5,3 12V <b>A+-D</b>	1x max 50							<b>T.1</b>	IN45	01 12 31 33 61 62 65	CE, IP20, 12V ac, A+
QT14 c G9 230V <b>D</b>	1x max 60								IN45G9	01 12 31 33 61 62 65	CE, IP20, 230V ac, A+

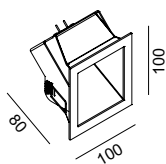

accessori - accessories- accesorios pag.556

## INCAS 90

92X90



	W	mA	K	lm product	lm/Led	CRI	△	A	CODE	Col.	
LED 50000h L90 B10 ta 25°C <b>A+</b>	5	500	3000	310	395	95	22°	<b>5.1</b>			CE, IP20, LED, A+
QR-CB51 GU5,3 12V <b>A+-D</b>	1x max 50							<b>T.1</b>	IN90	01 12 31 33 61 62 65	CE, IP20, 12V ac, A+
QPAR16 GU10 230V <b>A+-D</b>	1x max 50								IN90GU	01 12 31 33 61 62 65	CE, IP20, 230V ac, A+

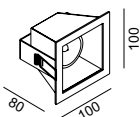

accessori - accessories- accesorios pag.556

- |  |  |   |
|--|--|---|
| 01 BIANCO-WHITE - BLANCO   | 12 GRIGIO-GREY - GRIS  | 31 CASSA BIANCA - CORNICE CROMO -WHITE BOX - CHROME FRAME - CAJA BLANCA - MARCO CROMO |
| 33 CASSA NERA - CORNICE CROMO -BLACK BOX - CHROME FRAME - CAJA NEGRA - MARCO CROMO   | 61 CASSA BIANCA - CORNICE SATINATA-WHITE BOX - SATIN FRAME - CAJA BLANCA - SATEN MARCO | 65 CASSA GRIGIA - CORNICE SATINATA -GREY BOX - SATIN FRAME - CAJA GRIS - SATEN MARCO  |
| 62 CASSA NERA - CORNICE SATINATA -BLACK BOX - SATIN FRAME - CAJA NEGRA - SATEN MARCO |  |   |



## INCAS 45 MICRO

54X54



LED	W	mA	K	lm product	lm/Led	CRI	∠	A	CODE	Col.	
50000h L70 B10 ta 25°C <b>A+</b>	1,5	500	3000	252	350	>80	16°	<b>5.1</b>	<b>IN93L1 01 12 31 33 61 62 65</b>		
	1,5	500	3000	136	189	>80	30°	<b>5.1</b>			

W	A	CODE	Col.	
QT12-LP GY6,35 12V	1 x max 35	<b>T.1</b>	<b>IN93 01 12 31 33 61 62 65</b>	

Il vetro diffusore satinato opzionale conferisce al prodotto grado di protezione IP40 | The optional frosted glass diffuser provides the fixture IP40 protection | El difusor en cristal satinado opzionale dar a la proteccion de productos IP40.

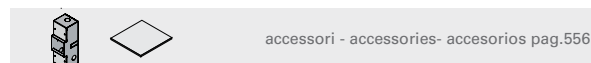
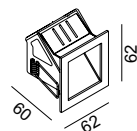

## INCAS 90 MICRO

54X54



LED	W	mA	K	lm product	lm/Led	CRI	∠	A	CODE	Col.	
50000h L70 B10 ta 25°C <b>A+</b>	1,5	500	3000	252	350	>80	16°	<b>5.1</b>	<b>IN92L1 01 12 31 33 61 62 65</b>		
	1,5	500	3000	136	189	>80	30°	<b>5.1</b>			

W	A	CODE	Col.	
QR-CB35 GU4 12V	1 x max 35	<b>T.1</b>	<b>IN92 01 12 31 33 61 62 65</b>	

Il vetro diffusore satinato opzionale conferisce al prodotto grado di protezione IP40 | The optional frosted glass diffuser provides the fixture IP40 protection | El difusor en cristal satinado opzionale dar a la proteccion de productos IP40.

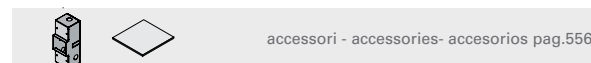
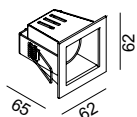

## VETRO DIFFUSORE SATINATO

FROSTED GLASS DIFFUSER - DIFUSOR EN CRISTAL SATINADO

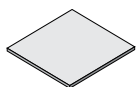

INCAS 45-90  
INCAS 45-90 MICRO

DIM.  
81x84  
46x47

CODE  
VT/IN45.90  
VT/IN92

L'inserimento di questo accessorio eleva il grado di protezione dell'apparecchio ad IP40 e IP43 - The inclusion of this accessory raises the protection degree of the lamp to IP40 and IP43 - La inclusión de este accesorio eleva el grado de protección hasta IP40 y IP43.

## CASSAFORMA

WALLBOX - CAJA



INCAS 45-90  
INCAS 45-90 MICRO

DIM. H  
95X80 200  
60X65 165

CODE  
CC94  
CC94M

Cassaforma in lamiera zincata per installazione in laterizio o calcestruzzo - galvanized metal wallbox for installing in brick or reinforced concrete - caja de metal galvanizado para instalar en ladrillo o de hormigón armado.

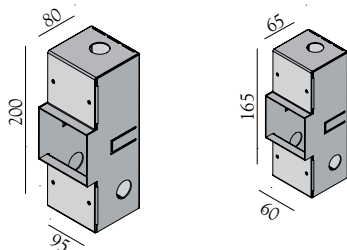



Apparecchio da incasso a parete per illuminazione segnapasso direzionata con angolo di 20°, per sorgente LED integrata o per lampade alogene/LED QT12-LP GY6,35 12V/230V con alimentazione remota disponibile come accessorio. Corpo e cornice di battuta super-slim larghezza 5 mm. in metallo verniciato. Installabile anche in pareti e soffitti in calcestruzzo mediante apposita cassaforma in lamiera zincata disponibile come accessorio. Grado di protezione IP20.

Recessed downlight for wall installation, for guidance lighting with 20° angle direction, for integrated LED source or for halogen/LED QT12-LP GY6,35 12V/230V lamps, with remote power supply available as an accessory. Body and super-slim 5 mm width frame in painted metal. It can also be installed in concrete or brick walls through specific galvanized steel wall-box, available as an accessory. Degree of protection IP20.

Lampara emportable por la pared y con angulo marcador direccional de 20°, LED integrado o para lampara halogena/LED QT12-LP GY6,35 12V/230V con reactancia remota disponible como accesorio. Cuerpo y marco super-slim 5mm de ancho. In metal pintado. Tambien puede ser instalado en paredes y techos de hormigon usando una caja en lamina de zinc, disponible como accesorio. Grado de proteccion IP20.

---

**STEP**









## STEP 75

27X69



LED  
50000h L70  
B10 ta 25°C

A+

W	mA	K	lm product	lm/Led	CRI	△
1,5	500	3000	252	350	>80	16°

A	Kg	CODE	Col.
5.1	0,2	LT1983BC	01 02



QT12-LP GY6,35 12V

B→C

W
1x max 35

A	Kg	CODE	Col.
T.1	0,2	LT1983	01 02

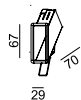

accessori - accessories- accesorios pag.563

## STEP 150

27X144



LED  
50000h L70  
B10 ta 25°C

A+

W	mA	K	lm product	lm/Led	CRI	△
1,5	500	3000	252	350	>80	16°

A	Kg	CODE	Col.
5.1	0,4	LT1982BC	01 02



QT12-LP GY6,35 12V

B→C

W
1x max 35

A	Kg	CODE	Col.
T.1	0,4	LT1982	01 02

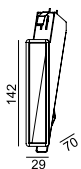

accessori - accessories- accesorios pag.563

## STEP 300

27X372



LED  
50000h L70  
B10 ta 25°C

A+

W	mA	K	lm product	lm/Led	CRI	△
1,5	500	3000	252	350	>80	16°

A	Kg	CODE	Col.
5.1	0,7	LT1981BC	01 02



QT12-LP GY6,35 12V

B→C

W
1x max 35

A	Kg	CODE	Col.
T.1	0,7	LT1981	01 02

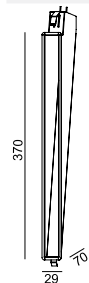

accessori - accessories- accesorios pag.563

01 - bianco - white - blanco

02 - nero - black - negro

pag.824

A pag.820

## CASSAFORMA STEP 75

WALLBOX STEP 75- CAJA STEP 75

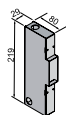

Dim.	H
30x80	220

CODE
LT1992



## CASSAFORMA STEP 150

WALLBOX STEP 150- CAJA STEP 150

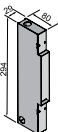

Dim.	H
30x80	265

CODE
LT1991



## CASSAFORMA STEP 300

WALLBOX STEP 300- CAJA STEP 300

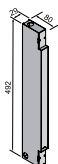

Dim.	H
30x80	495

CODE
LT1990



Apparecchio da incasso a parete per illuminazione indiretta, completo di sorgente lineare LED da completare con driver remoto o per lampade fluorescenti compatte TC-TEL GX24q3/4 completo di alimentazione elettronica 50/60Hz 230/240V o alogene QT-DE 12 R7S 230V/240V. Disponibile in versione con cornice di battuta o a scomparsa totale trimless. Corpo e cornice di battuta super-slim larghezza 15 mm. in metallo verniciato. Particolari meccanici in acciaio. Completo di schermo di protezione in vetro temperato. Installabile anche in pareti e soffitti in calcestruzzo mediante apposita cassaforma in lamiera zincata disponibile come accessorio. Grado di protezione IP20.

Recessed downlighter for wall installation, for indirect lighting, complete with linear LED to be complete with remote power supply or for TC-TEL GX24 q3-4 compact fluorescent lamps, complete with electronic power-supply 50/60Hz 230/240V or for halogen QT-DE 12 R7S 230V/240V lamps. Available in version with frame or trimless. Body and super-slim 15 mm width frame in painted metal. Mechanical details steel-made. Complete with safety tempered glass and high efficiency pre-anodized aluminium reflector. It can also be installed in concrete or brick walls through specific galvanized steel wall-box, available as an accessory. Degree of protection IP20.

Lampara emportable en pared para iluminacion indirecta, completo de linear LED a completar con alimentador remoto o para lamparas fluorescentes compactas TC-TEL GX24 q3-4 completos de reactancia electronica 50/60Hz 230/240V o halogeno QT-DE 12 R7S 230V/240V. Disponible en version con o sin marco. Cuerpo y marco super-slim 15 mm de ancho en metal pintado. Piezas mecanicas de acero. Completo con pantalla de vidrio de seguridad templado y reflector de aluminio pre-anodizado de alta eficiencia. Tambien puede ser instalado en paredes y techos de hormigon usando una caja en lamina de zinc disponible como accesorio. Grado de proteccion IP20.

**WINDOW**





CONSERVATORIO A. BOITO PARMA - ITALY  
PROJECT F.LLI SCORPINETTI  
PHOTO M.FLORES



## WINDOW 224

208x208



	W	mA	K	lm product	lm/Led	CRI	A	CODE	Col.	
LED 6,2W 16,0-19,6V CRI>90 16V <b>A+</b>	12,4	350	3000	1400	1400	>90	<b>3.4</b>	<b>WI001.930</b>	<b>01 12</b>	
	12,4	350	4000	1480	1480	>90	<b>3.4</b>			

Da completare con alimentatore remoto -To be completed with remote driver - A completar con alimentador remoto

	W	CODE	Col.	
QTDE 12 R7s 230V 	120	<b>WI002</b>	<b>01 12</b>	

	W	DaliT&D	CODE	Col.	
TC-TEL GX24-c3-4 230V  <b>A-B</b>	26/32/42 26/32/42	x	<b>WI003</b> <b>WI003D</b>	<b>01 12</b> <b>01 12</b>	



accessori - accessories- accesorios pag.570

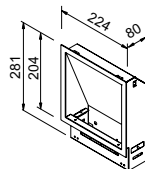

## WINDOW 306

290X208



	W	mA	K	lm product	lm/Led	CRI	A	CODE	Col.	
LED 6,2W 16,0-19,6V CRI>90 16V <b>A+</b>	12,4	350	3000	1400	1400	>90	<b>3.4</b>	<b>WI011.930</b>	<b>01 12</b>	
	12,4	350	4000	1480	1480	>90	<b>3.4</b>			

Da completare con alimentatore remoto -To be completed with remote driver - A completar con alimentador remoto

	W	CODE	Col.	
QTDE 12 R7s 230V 	120	<b>WI012</b>	<b>01 12</b>	

	W	DaliT&D	CODE	Col.	
TC-TEL GX24-c3-4 230V  <b>A-B</b>	26/32/42 26/32/42	x	<b>WI013</b> <b>WI013D</b>	<b>01 12</b> <b>01 12</b>	



accessori - accessories- accesorios pag.570

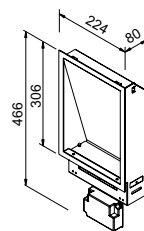

01 - bianco - white - blanco    12 - grigio - grey - gris

pag.824

**A** pag.820



## WINDOW M 224

200x200



	W	mA	K	lm product	lm/Led	CRI	A	CODE	Col.				
LED 6,2W 16,0-19,6V CRI>90 16V <b>A+</b>	12,4	350	3000	1400	1400	>90	<b>3.4</b>	<b>WI101.930</b>	<b>01</b>				
	12,4	350	4000	1480	1480	>90	<b>3.4</b>						
Da completare con alimentatore remoto -To be completed with remote driver - A completar con alimentador remoto													
QTDE 12 R7s 230V <b>A→D</b>	W										CODE	Col.	
	120										<b>WI102</b>	<b>01</b>	
TC-TEL GX24-c3-4 230V <b>A→B</b>	W										CODE	Col.	
	26/32/42 26/32/42	DaliT&D x									<b>WI103</b> <b>WI103D</b>	<b>01</b> <b>01</b>	 

Per installazione in pareti di laterizio non necessita di cassaforma/ For installation in brick walls does not require wallbox./ Para el montaje en paredes de ladrillo no requiere caja.

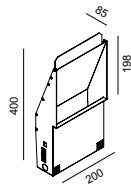

## WINDOW M 306

282X200



	W	mA	K	lm product	lm/Led	CRI	A	CODE	Col.				
LED 6,2W 16,0-19,6V CRI>90 16V <b>A+</b>	12,4	350	3000	1400	1400	>90	<b>3.4</b>	<b>WI111.930</b>	<b>01</b>				
	12,4	350	4000	1480	1480	>90	<b>3.4</b>						
Da completare con alimentatore remoto -To be completed with remote driver - A completar con alimentador remoto													
QTDE 12 R7s 230V <b>A→D</b>	W										CODE	Col.	
	120										<b>WI112</b>	<b>01</b>	 
TC-TEL GX24-c3-4 230V <b>A→B</b>	W										CODE	Col.	
	26/32/42 26/32/42	DaliT&D x									<b>WI113</b> <b>WI113D</b>	<b>01</b> <b>01</b>	 

Per installazione in pareti di laterizio non necessita di cassaforma/ For installation in brick walls does not require wallbox./ Para el montaje en paredes de ladrillo no requiere caja.

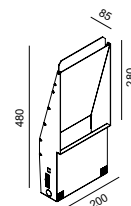

01 - bianco - white - blanco

pag.824

**A** pag.820

## CASSAFORMA WINDOW 224

WALLBOX WINDOW 224- CAJA WINDOW 224

CODE

LT1692



Solo per versioni con cornice | Only for frame version | Solo por producto con marco

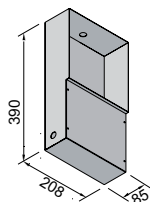

## CASSAFORMA WINDOW 306

WALLBOX WINDOW 306- CAJA WINDOW 306

CODE

LT1693



Solo per versioni con cornice | Only for frame version | Solo por producto con marco

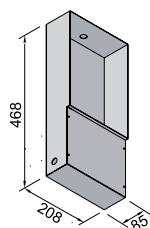





CONSERVATORIO A. BOITO PARMA - ITALY  
PROJECT F. LLI SCORPINETTI  
PHOTO M. FLORES



## PROIETTORI • PROJECTORS • PROYECTORES RANGE

SEMPLICE p.576



PHAR p.604



PRO IN p.592

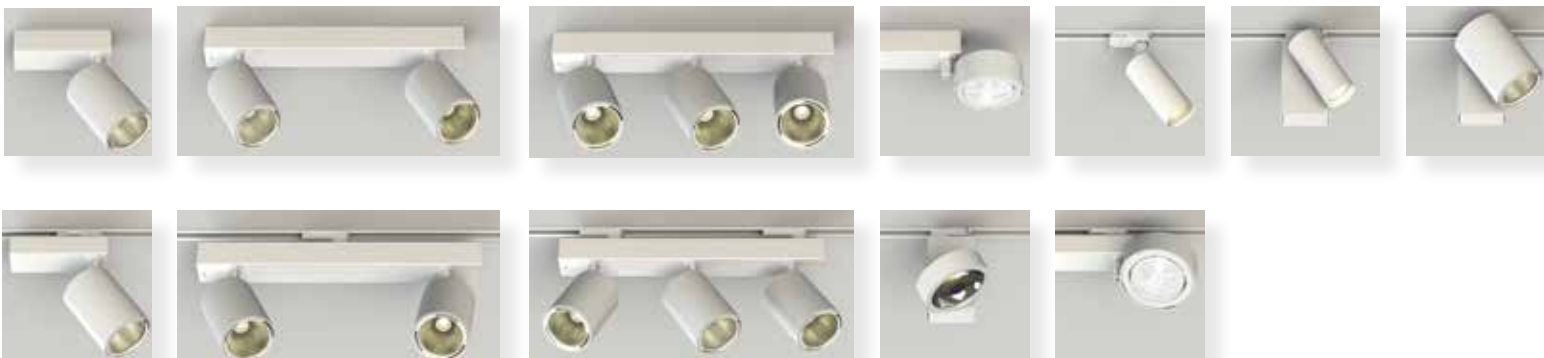

BI-CUBO p.616



EXTENSOR p.624



MINIFILE OPENLIGHT TRACK p.632



FILE 2 TRACK p.638



TRACKS p.644







Proiettore professionale da binario Eurostandard 230V o da parete e soffitto completo di sorgente LED nelle seguenti versioni 2700K- 3000K- 4000K con ottiche da 15°- 24°- 38° intercambiabili Twist & Lock, anche in versione dimmerabile dali e dimmerabile taglio di fase. Versioni da binario complete di adattatore Eurostandard. Adattatore compatibile con binari One Track (A.A.G. Stucchi ) o Global Track pulse (Nordic Aluminium). Corpo e gruppo ottico di sezione cilindrica in estruso di alluminio verniciato. Snodi meccanici in acciaio. Orientabilità del gruppo ottico dalla posizione di riposo verticale di 355° sull'asse verticale e da 0° a 90° su quello orizzontale mediante braccio a slitta. Mantenimento della posizione grazie al blocco di puntamento.

Professional projectors for 230V Eurostandard track or ceiling-wall installation. Complete with professional LED source 2700K, 3000K e 4000K; optic 15°, 24° e 38° interchangeable Twist & Lock, also available in dali or trailing/leading edge dimmable version. Track versions supplied with euro adaptor. Compatible with track One Track (A.A.G. Stucchi ) or Global Track pulse (Nordic Aluminium). Cylindrical body and optical group in painted extruded aluminium. Mechanical joints steel-made. Optical group 355° vertically and +/- 90° horizontally adjustable through sliding-rod mechanism. Maintaining the position by blocking pointing.

Proyectores para raíl Eurostandard 230V, o pared y techo con LED profesionales 2700K, 3000K y 4000K con óptica de 15°, 24°, 38° intercambiable Twist & Lock y versiones dimmable. Versiones a raíl con adaptador Eurostandard. Se puede usar en el binario OneTrack (A.A.G. Stucchi ) or GlobalTrack pulse (Nordic Aluminium). Cuerpo y grupo óptico de sección cilíndrica en estruso de aluminio pintado. Codos macánicos en acero. Orientabilidad del grupo óptico desde la posición de descanso vertical de 355° sobre el eje vertical y de 0° a 90° sobre el horizontal mediante brazo deslizante. Mantenimiento de la posición mediante tornillo.



SEMPLICE TRACK

PROJECTORS



TABAKALERA - CENTRO INTERNACIONAL DE CULTURA CONTEMPORÁNEA - SPAIN  
LIGHTING PROJECT TAO ILLUMINACION







RISTORANTE "GANZO" FIRENZE - ITALY  
PROJECT ARC.MASSIMO MATERASSI





## SEMPLICE B55 BINARIO

TRACK PROJECTOR - PROYECTOR POR CARRIL



LED

3SDCM  
50000h L90  
B10 ta 25°C

A+

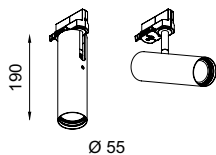

W	K	lm product	lm/Led	CRI	△	Dim.	H	Kg	CODE	Col.
11	2700	931	1100	>90	29°	ø55	190	1,0	SE400.927S	01 02 49
11	2700	703	1100	>90	42°	ø55	190	1,0	SE400.927F	01 02 49
11	3000	1003	1185	>90	29°	ø55	190	1,0	SE400.930S	01 02 49
11	3000	757	1185	>90	42°	ø55	190	1,0	SE400.930F	01 02 49
11	4000	1088	1285	>90	29°	ø55	190	1,0	SE400.940S	01 02 49
11	4000	821	1285	>90	42°	ø55	190	1,0	SE400.940F	01 02 49



RUOTE DA SOGNO REGGIO EMILIA - ITALY

PROJECT ARCH. ANDREA OLIVA

PHOTO KAI UWE SCHULTE BUNERC



# SEMPLICE B90 BINARIO

TRACK PROJECTOR - PROYECTOR POR CARRIL



LED

W	K	lm product	lm/Led	CRI	Dali	DimTF	∠	Dim.	H	Kg	CODE	Col.
17	2700	1438	1790	95			15°	ø90	215	1,6	SE401.927S	01 02 49
17	2700	1438	1790	95	x		15°	ø90	215	1,6	SE401.927SD	01 02 49
17	2700	1438	1790	95		x	15°	ø90	215	1,6	SE401.927SDF	01 02 49
17	2700	1530	1790	95			24°	ø90	215	1,6	SE401.927F	01 02 49
17	2700	1530	1790	95	x		24°	ø90	215	1,6	SE401.927FD	01 02 49
17	2700	1530	1790	95		x	24°	ø90	215	1,6	SE401.927FDF	01 02 49
17	2700	1609	1790	95			38°	ø90	215	1,6	SE401.927W	01 02 49
17	2700	1609	1790	95	x		38°	ø90	215	1,6	SE401.927WD	01 02 49
17	2700	1609	1790	95		x	38°	ø90	215	1,6	SE401.927WDF	01 02 49
17	3000	1546	1925	95			15°	ø90	215	1,6	SE401.930S	01 02 49
17	3000	1546	1925	95	x		15°	ø90	215	1,6	SE401.930SD	01 02 49
17	3000	1546	1925	95		x	15°	ø90	215	1,6	SE401.930SDF	01 02 49
17	3000	1645	1925	95			24°	ø90	215	1,6	SE401.930F	01 02 49
17	3000	1645	1925	95	x		24°	ø90	215	1,6	SE401.930FD	01 02 49
17	3000	1645	1925	95		x	24°	ø90	215	1,6	SE401.930FDF	01 02 49
17	3000	1730	1925	95			38°	ø90	215	1,6	SE401.930W	01 02 49
17	3000	1730	1925	95	x		38°	ø90	215	1,6	SE401.930WD	01 02 49
17	3000	1730	1925	95		x	38°	ø90	215	1,6	SE401.930WDF	01 02 49
17	4000	1699	2115	95			15°	ø90	215	1,6	SE401.940S	01 02 49
17	4000	1699	2115	95	x		15°	ø90	215	1,6	SE401.940SD	01 02 49
17	4000	1699	2115	95		x	15°	ø90	215	1,6	SE401.940SDF	01 02 49
17	4000	1807	2115	95			24°	ø90	215	1,6	SE401.940F	01 02 49
17	4000	1807	2115	95	x		24°	ø90	215	1,6	SE401.940FD	01 02 49
17	4000	1807	2115	95		x	24°	ø90	215	1,6	SE401.940FDF	01 02 49
17	4000	1901	2115	95			38°	ø90	215	1,6	SE401.940W	01 02 49
17	4000	1901	2115	95	x		38°	ø90	215	1,6	SE401.940WD	01 02 49
17	4000	1901	2115	95		x	38°	ø90	215	1,6	SE401.940WDF	01 02 49
24,3	2700	1904	2370	95			15°	ø90	215	1,6	SE402.927S	01 02 49
24,3	2700	1904	2370	95	x		15°	ø90	215	1,6	SE402.927SD	01 02 49
24,3	2700	1904	2370	95		x	15°	ø90	215	1,6	SE402.927SDF	01 02 49
24,3	2700	2011	2370	95			24°	ø90	215	1,6	SE402.927F	01 02 49
24,3	2700	2011	2370	95	x		24°	ø90	215	1,6	SE402.927FD	01 02 49
24,3	2700	2011	2370	95		x	24°	ø90	215	1,6	SE402.927FDF	01 02 49
24,3	2700	2095	2370	95			38°	ø90	215	1,6	SE402.927W	01 02 49
24,3	2700	2095	2370	95	x		38°	ø90	215	1,6	SE402.927WD	01 02 49
24,3	2700	2095	2370	95		x	38°	ø90	215	1,6	SE402.927WDF	01 02 49
24,3	3000	2045	2545	95			15°	ø90	215	1,6	SE402.930S	01 02 49
24,3	3000	2045	2545	95	x		15°	ø90	215	1,6	SE402.930SD	01 02 49
24,3	3000	2045	2545	95		x	15°	ø90	215	1,6	SE402.930SDF	01 02 49
24,3	3000	2160	2545	95			24°	ø90	215	1,6	SE402.930F	01 02 49
24,3	3000	2160	2545	95	x		24°	ø90	215	1,6	SE402.930FD	01 02 49
24,3	3000	2160	2545	95		x	24°	ø90	215	1,6	SE402.930FDF	01 02 49
24,3	3000	2250	2545	95			38°	ø90	215	1,6	SE402.930W	01 02 49
24,3	3000	2250	2545	95	x		38°	ø90	215	1,6	SE402.930WD	01 02 49
24,3	3000	2250	2545	95		x	38°	ø90	215	1,6	SE402.930WDF	01 02 49
24,3	4000	2250	2800	95			15°	ø90	215	1,6	SE402.940S	01 02 49
24,3	4000	2250	2800	95	x		15°	ø90	215	1,6	SE402.940SD	01 02 49
24,3	4000	2250	2800	95		x	15°	ø90	215	1,6	SE402.940SDF	01 02 49
24,3	4000	2376	2800	95			24°	ø90	215	1,6	SE402.940F	01 02 49
24,3	4000	2376	2800	95	x		24°	ø90	215	1,6	SE402.940FD	01 02 49
24,3	4000	2376	2800	95		x	24°	ø90	215	1,6	SE402.940FDF	01 02 49
24,3	4000	2475	2800	95			38°	ø90	215	1,6	SE402.940W	01 02 49
24,3	4000	2475	2800	95	x		38°	ø90	215	1,6	SE402.940WD	01 02 49
24,3	4000	2475	2800	95		x	38°	ø90	215	1,6	SE402.940WDF	01 02 49

3SDCM  
50000h ta  
L90 B10 ta  
25°



Dali : Versione dimmerabile Dali. Adattatore compatibile con binari One Track (A.A.G. Stucchi ) o Global Track pulse (Nordic Aluminium)/ Dimmable Dali version. For connection to the One Track (A.A.G. Stucchi ) or Global Track pulse (Nordic Aluminium)/ Versione dimmabile Dali. Se puede usar en el binario One Track (A.A.G. Stucchi ) or Global Track pulse (Nordic Aluminium)  
DimTF: Versione dimmerabile taglio di fase / Trailing/leading edge dimmable version / Versione dimmabile corte de fase.



accessori - accessories  
accesorios pag. 590

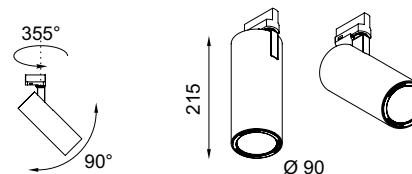

## SEMPLICE B120 BINARIO

TRACK PROJECTOR - PROYECTOR POR CARRIL



LED

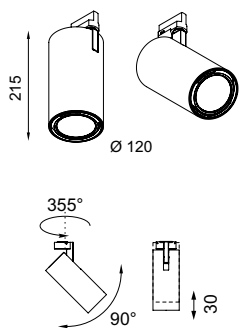

accessori - accessories  
accesorios pag. 590

3SDCM  
50000h  
L90 B10 ta  
25°

A+

W	K	Im product	Im/Led	CRI	Dali	DimTF	∠	Dim.	H	Kg	CODE	Col.
17	2700	1438	1790	95			15°	ø120	215	1,8	SE421.927S	01 02 49
17	2700	1438	1790	95	x		15°	ø120	215	1,8	SE421.927SD	01 02 49
17	2700	1438	1790	95		x	15°	ø120	215	1,8	SE421.927SDF	01 02 49
17	2700	1530	1790	95			24°	ø120	215	1,8	SE421.927F	01 02 49
17	2700	1530	1790	95	x		24°	ø120	215	1,8	SE421.927FD	01 02 49
17	2700	1530	1790	95		x	24°	ø120	215	1,8	SE421.927FDF	01 02 49
17	2700	1609	1790	95			38°	ø120	215	1,8	SE421.927W	01 02 49
17	2700	1609	1790	95	x		38°	ø120	215	1,8	SE421.927WD	01 02 49
17	2700	1609	1790	95		x	38°	ø120	215	1,8	SE421.927WDF	01 02 49
17	3000	1546	1925	95			15°	ø120	215	1,8	SE421.930S	01 02 49
17	3000	1546	1925	95	x		15°	ø120	215	1,8	SE421.930SD	01 02 49
17	3000	1546	1925	95		x	15°	ø120	215	1,8	SE421.930SDF	01 02 49
17	3000	1645	1925	95			24°	ø120	215	1,8	SE421.930F	01 02 49
17	3000	1645	1925	95	x		24°	ø120	215	1,8	SE421.930FD	01 02 49
17	3000	1645	1925	95		x	24°	ø120	215	1,8	SE421.930FDF	01 02 49
17	3000	1730	1925	95			38°	ø120	215	1,8	SE421.930W	01 02 49
17	3000	1730	1925	95	x		38°	ø120	215	1,8	SE421.930WD	01 02 49
17	3000	1730	1925	95		x	38°	ø120	215	1,8	SE421.930WDF	01 02 49
17	4000	1699	2115	95			15°	ø120	215	1,8	SE421.940S	01 02 49
17	4000	1699	2115	95	x		15°	ø120	215	1,8	SE421.940SD	01 02 49
17	4000	1699	2115	95		x	15°	ø120	215	1,8	SE421.940SDF	01 02 49
17	4000	1807	2115	95			24°	ø120	215	1,8	SE421.940F	01 02 49
17	4000	1807	2115	95	x		24°	ø120	215	1,8	SE421.940FD	01 02 49
17	4000	1807	2115	95		x	24°	ø120	215	1,8	SE421.940FDF	01 02 49
17	4000	1901	2115	95			38°	ø120	215	1,8	SE421.940W	01 02 49
17	4000	1901	2115	95	x		38°	ø120	215	1,8	SE421.940WD	01 02 49
17	4000	1901	2115	95		x	38°	ø120	215	1,8	SE421.940WDF	01 02 49
24,3	2700	1904	2370	95			15°	ø120	215	1,8	SE422.927S	01 02 49
24,3	2700	1904	2370	95	x		15°	ø120	215	1,8	SE422.927SD	01 02 49
24,3	2700	1904	2370	95		x	15°	ø120	215	1,8	SE422.927SDF	01 02 49
24,3	2700	2011	2370	95			24°	ø120	215	1,8	SE422.927F	01 02 49
24,3	2700	2011	2370	95	x		24°	ø120	215	1,8	SE422.927FD	01 02 49
24,3	2700	2011	2370	95		x	24°	ø120	215	1,8	SE422.927FDF	01 02 49
24,3	2700	2095	2370	95			38°	ø120	215	1,8	SE422.927W	01 02 49
24,3	2700	2095	2370	95	x		38°	ø120	215	1,8	SE422.927WD	01 02 49
24,3	2700	2095	2370	95		x	38°	ø120	215	1,8	SE422.927WDF	01 02 49
24,3	3000	2045	2545	95			15°	ø120	215	1,8	SE422.930S	01 02 49
24,3	3000	2045	2545	95	x		15°	ø120	215	1,8	SE422.930SD	01 02 49
24,3	3000	2045	2545	95		x	15°	ø120	215	1,8	SE422.930SDF	01 02 49
24,3	3000	2160	2545	95			24°	ø120	215	1,8	SE422.930F	01 02 49
24,3	3000	2160	2545	95	x		24°	ø120	215	1,8	SE422.930FD	01 02 49
24,3	3000	2160	2545	95		x	24°	ø120	215	1,8	SE422.930FDF	01 02 49
24,3	3000	2250	2545	95			38°	ø120	215	1,8	SE422.930W	01 02 49
24,3	3000	2250	2545	95	x		38°	ø120	215	1,8	SE422.930WD	01 02 49
24,3	3000	2250	2545	95		x	38°	ø120	215	1,8	SE422.930WDF	01 02 49
24,3	4000	2250	2800	95			15°	ø120	215	1,8	SE422.940S	01 02 49
24,3	4000	2250	2800	95	x		15°	ø120	215	1,8	SE422.940SD	01 02 49
24,3	4000	2250	2800	95		x	15°	ø120	215	1,8	SE422.940SDF	01 02 49
24,3	4000	2376	2800	95			24°	ø120	215	1,8	SE422.940F	01 02 49
24,3	4000	2376	2800	95	x		24°	ø120	215	1,8	SE422.940FD	01 02 49
24,3	4000	2376	2800	95		x	24°	ø120	215	1,8	SE422.940FDF	01 02 49
24,3	4000	2475	2800	95			38°	ø120	215	1,8	SE422.940W	01 02 49
24,3	4000	2475	2800	95	x		38°	ø120	215	1,8	SE422.940WD	01 02 49
24,3	4000	2475	2800	95		x	38°	ø120	215	1,8	SE422.940WDF	01 02 49
375	2700	2547	3530	95			15°	ø120	215	1,8	SE423.927S	01 02 49
375	2700	2547	3530	95	x		15°	ø120	215	1,8	SE423.927SD	01 02 49
375	2700	2692	3530	95			24°	ø120	215	1,8	SE423.927F	01 02 49
375	2700	2692	3530	95	x		24°	ø120	215	1,8	SE423.927FD	01 02 49
375	2700	2817	3530	95			38°	ø120	215	1,8	SE423.927W	01 02 49
375	2700	2817	3530	95	x		38°	ø120	215	1,8	SE423.927WD	01 02 49
375	3000	2731	3785	95			15°	ø120	215	1,8	SE423.930S	01 02 49
375	3000	2731	3785	95	x		15°	ø120	215	1,8	SE423.930SD	01 02 49
375	3000	2886	3785	95			24°	ø120	215	1,8	SE423.930F	01 02 49
375	3000	2886	3785	95	x		24°	ø120	215	1,8	SE423.930FD	01 02 49
375	3000	3020	3785	95			38°	ø120	215	1,8	SE423.930W	01 02 49
375	3000	3020	3785	95	x		38°	ø120	215	1,8	SE423.930WD	01 02 49
375	4000	2998	4155	95			15°	ø120	215	1,8	SE423.940S	01 02 49
375	4000	2998	4155	95	x		15°	ø120	215	1,8	SE423.940SD	01 02 49
375	4000	3168	4155	95			24°	ø120	215	1,8	SE423.940F	01 02 49
375	4000	3168	4155	95	x		24°	ø120	215	1,8	SE423.940FD	01 02 49
375	4000	3315	4155	95			38°	ø120	215	1,8	SE423.940W	01 02 49
375	4000	3315	4155	95	x		38°	ø120	215	1,8	SE423.940WD	01 02 49





Dali : Versione dimmerabile Dali. Adattatore compatibile con binari One Track (A.A.G. Stucchi ) o Global Track pulse (Nordic Aluminium)/ Dimmable Dali version. Compatible with track One Track (A.A.G. Stucchi ) or Global Track pulse (Nordic Aluminium)/ Versione dimmabile Dali. Compatible con el binario One Track (A.A.G. Stucchi ) or Global Track pulse (Nordic Aluminium)  
 DimTF: Versione dimmerabile taglio di fase / Trailing/leading edge dimmable version / Versione dimmabile corte de fase.



accessori - accessories  
 accesorios pag. 590

01 - bianco - white - blanco 02 - nero - black - negro 49 - moka - moka - moka

 pag.824



## Posizioni di lavoro

Il braccio a slitta permette di assumere diverse posizioni di lavoro e di mantenerle grazie al blocco del puntamento.

## Working positions

The slide rod allows to take different working positions and keep them through the aiming lock mechanism.



CEILING POSITION



SUSPENDED POSITION



AIMING POSITION

## SEMPLICE P90 PARETE-SOFFITTO

WALL & CEILING PROJECTOR - PROYECTOR PARED Y TECHO



LED

W	K	lm product	lm/Led	CRI	Dali	DimTF	∠	Dim.	H	Kg	CODE	Col.
17	2700	1438	1790	95			15°	ø90	240-270	1,4	SE501.927S	01 02 49
17	2700	1438	1790	95	x		15°	ø90	240-270	1,4	SE501.927SD	01 02 49
17	2700	1438	1790	95		x	15°	ø90	240-270	1,4	SE501.927SDF	01 02 49
17	2700	1530	1790	95			24°	ø90	240-270	1,4	SE501.927F	01 02 49
17	2700	1530	1790	95	x		24°	ø90	240-270	1,4	SE501.927FD	01 02 49
17	2700	1530	1790	95		x	24°	ø90	240-270	1,4	SE501.927FDF	01 02 49
17	2700	1609	1790	95			38°	ø90	240-270	1,4	SE501.927W	01 02 49
17	2700	1609	1790	95	x		38°	ø90	240-270	1,4	SE501.927WD	01 02 49
17	2700	1609	1790	95		x	38°	ø90	240-270	1,4	SE501.927WDF	01 02 49
17	3000	1546	1925	95			15°	ø90	240-270	1,4	SE501.930S	01 02 49
17	3000	1546	1925	95	x		15°	ø90	240-270	1,4	SE501.930SD	01 02 49
17	3000	1546	1925	95		x	15°	ø90	240-270	1,4	SE501.930SDF	01 02 49
17	3000	1645	1925	95			24°	ø90	240-270	1,4	SE501.930F	01 02 49
17	3000	1645	1925	95	x		24°	ø90	240-270	1,4	SE501.930FD	01 02 49
17	3000	1645	1925	95		x	24°	ø90	240-270	1,4	SE501.930FDF	01 02 49
17	3000	1730	1925	95			38°	ø90	240-270	1,4	SE501.930W	01 02 49
17	3000	1730	1925	95	x		38°	ø90	240-270	1,4	SE501.930WD	01 02 49
17	3000	1730	1925	95		x	38°	ø90	240-270	1,4	SE501.930WDF	01 02 49
17	4000	1699	2115	95			15°	ø90	240-270	1,4	SE501.940S	01 02 49
17	4000	1699	2115	95	x		15°	ø90	240-270	1,4	SE501.940SD	01 02 49
17	4000	1699	2115	95		x	15°	ø90	240-270	1,4	SE501.940SDF	01 02 49
17	4000	1807	2115	95			24°	ø90	240-270	1,4	SE501.940F	01 02 49
17	4000	1807	2115	95	x		24°	ø90	240-270	1,4	SE501.940FD	01 02 49
17	4000	1807	2115	95		x	24°	ø90	240-270	1,4	SE501.940FDF	01 02 49
17	4000	1901	2115	95			38°	ø90	240-270	1,4	SE501.940W	01 02 49
17	4000	1901	2115	95	x		38°	ø90	240-270	1,4	SE501.940WD	01 02 49
17	4000	1901	2115	95		x	38°	ø90	240-270	1,4	SE501.940WDF	01 02 49
24,3	2700	1904	2370	95			15°	ø90	240-270	1,4	SE502.927S	01 02 49
24,3	2700	1904	2370	95	x		15°	ø90	240-270	1,4	SE502.927SD	01 02 49
24,3	2700	1904	2370	95		x	15°	ø90	240-270	1,4	SE502.927SDF	01 02 49
24,3	2700	2011	2370	95			24°	ø90	240-270	1,4	SE502.927F	01 02 49
24,3	2700	2011	2370	95	x		24°	ø90	240-270	1,4	SE502.927FD	01 02 49
24,3	2700	2011	2370	95		x	24°	ø90	240-270	1,4	SE502.927FDF	01 02 49
24,3	2700	2095	2370	95			38°	ø90	240-270	1,4	SE502.927W	01 02 49
24,3	2700	2095	2370	95	x		38°	ø90	240-270	1,4	SE502.927WD	01 02 49
24,3	2700	2095	2370	95		x	38°	ø90	240-270	1,4	SE502.927WDF	01 02 49
24,3	3000	2045	2545	95			15°	ø90	240-270	1,4	SE502.930S	01 02 49
24,3	3000	2045	2545	95	x		15°	ø90	240-270	1,4	SE502.930SD	01 02 49
24,3	3000	2045	2545	95		x	15°	ø90	240-270	1,4	SE502.930SDF	01 02 49
24,3	3000	2160	2545	95			24°	ø90	240-270	1,4	SE502.930F	01 02 49
24,3	3000	2160	2545	95	x		24°	ø90	240-270	1,4	SE502.930FD	01 02 49
24,3	3000	2160	2545	95		x	24°	ø90	240-270	1,4	SE502.930FDF	01 02 49
24,3	3000	2250	2545	95			38°	ø90	240-270	1,4	SE502.930W	01 02 49
24,3	3000	2250	2545	95	x		38°	ø90	240-270	1,4	SE502.930WD	01 02 49
24,3	3000	2250	2545	95		x	38°	ø90	240-270	1,4	SE502.930WDF	01 02 49
24,3	4000	2250	2800	95			15°	ø90	240-270	1,4	SE502.940S	01 02 49
24,3	4000	2250	2800	95	x		15°	ø90	240-270	1,4	SE502.940SD	01 02 49
24,3	4000	2250	2800	95		x	15°	ø90	240-270	1,4	SE502.940SDF	01 02 49
24,3	4000	2376	2800	95			24°	ø90	240-270	1,4	SE502.940F	01 02 49
24,3	4000	2376	2800	95	x		24°	ø90	240-270	1,4	SE502.940FD	01 02 49
24,3	4000	2376	2800	95		x	24°	ø90	240-270	1,4	SE502.940FDF	01 02 49
24,3	4000	2475	2800	95			38°	ø90	240-270	1,4	SE502.940W	01 02 49
24,3	4000	2475	2800	95	x		38°	ø90	240-270	1,4	SE502.940WD	01 02 49
24,3	4000	2475	2800	95		x	38°	ø90	240-270	1,4	SE502.940WDF	01 02 49

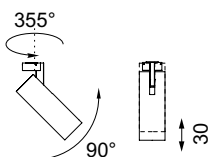
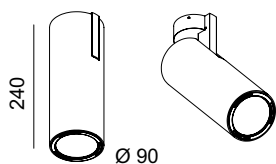

3SDCM  
50000h  
L90 B10 ta  
25°



Dali : Versione dimmerabile Dali / Dimmable Dali version / Versione dimmable Dali  
DimTF: Versione dimmerabile Taglio di fase / Trailing/leading edge dimmable version / Versione dimmable corte de fase.



accessori - accessories  
accesorios pag. 590

01 - bianco - white - blanco    02 - nero - black - negro    49 - moka - moka - moka





# SEMPLICE P120 PARETE-SOFFITTO

WALL & CEILING PROJECTOR - PROYECTOR PARED Y TECHO



LED

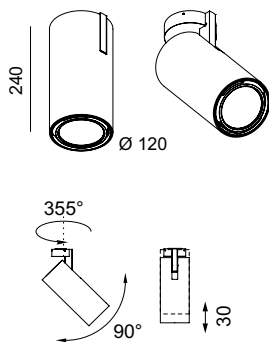

accessori - accessories  
accesorios pag. 590

3SDCM  
50000h  
L90 B10 ta  
25° **A+**

W	K	Im product	Im/Led	CRI	Dali	DimTF	∠	Dim.	H	Kg	CODE	Col.
17	2700	1438	1790	95			15°	Ø120	240-270	1,7	SE521.927S	01 02 49
17	2700	1438	1790	95	x		15°	Ø120	240-270	1,7	SE521.927SD	01 02 49
17	2700	1438	1790	95		x	15°	Ø120	240-270	1,7	SE521.927SDF	01 02 49
17	2700	1530	1790	95			24°	Ø120	240-270	1,7	SE521.927F	01 02 49
17	2700	1530	1790	95	x		24°	Ø120	240-270	1,7	SE521.927FD	01 02 49
17	2700	1530	1790	95		x	24°	Ø120	240-270	1,7	SE521.927FDF	01 02 49
17	2700	1609	1790	95			38°	Ø120	240-270	1,7	SE521.927W	01 02 49
17	2700	1609	1790	95	x		38°	Ø120	240-270	1,7	SE521.927WD	01 02 49
17	2700	1609	1790	95		x	38°	Ø120	240-270	1,7	SE521.927WDF	01 02 49
17	3000	1546	1925	95			15°	Ø120	240-270	1,7	SE521.930S	01 02 49
17	3000	1546	1925	95	x		15°	Ø120	240-270	1,7	SE521.930SD	01 02 49
17	3000	1546	1925	95		x	15°	Ø120	240-270	1,7	SE521.930SDF	01 02 49
17	3000	1645	1925	95			24°	Ø120	240-270	1,7	SE521.930F	01 02 49
17	3000	1645	1925	95	x		24°	Ø120	240-270	1,7	SE521.930FD	01 02 49
17	3000	1645	1925	95		x	24°	Ø120	240-270	1,7	SE521.930FDF	01 02 49
17	3000	1730	1925	95			38°	Ø120	240-270	1,7	SE521.930W	01 02 49
17	3000	1730	1925	95	x		38°	Ø120	240-270	1,7	SE521.930WD	01 02 49
17	3000	1730	1925	95		x	38°	Ø120	240-270	1,7	SE521.930WDF	01 02 49
17	4000	1699	2115	95			15°	Ø120	240-270	1,7	SE521.940S	01 02 49
17	4000	1699	2115	95	x		15°	Ø120	240-270	1,7	SE521.940SD	01 02 49
17	4000	1699	2115	95		x	15°	Ø120	240-270	1,7	SE521.940SDF	01 02 49
17	4000	1807	2115	95			24°	Ø120	240-270	1,7	SE521.940F	01 02 49
17	4000	1807	2115	95	x		24°	Ø120	240-270	1,7	SE521.940FD	01 02 49
17	4000	1807	2115	95		x	24°	Ø120	240-270	1,7	SE521.940FDF	01 02 49
17	4000	1901	2115	95			38°	Ø120	240-270	1,7	SE521.940W	01 02 49
17	4000	1901	2115	95	x		38°	Ø120	240-270	1,7	SE521.940WD	01 02 49
17	4000	1901	2115	95		x	38°	Ø120	240-270	1,7	SE521.940WDF	01 02 49
24,3	2700	1904	2370	95			15°	Ø120	240-270	1,7	SE522.927S	01 02 49
24,3	2700	1904	2370	95	x		15°	Ø120	240-270	1,7	SE522.927SD	01 02 49
24,3	2700	1904	2370	95		x	15°	Ø120	240-270	1,7	SE522.927SDF	01 02 49
24,3	2700	2011	2370	95			24°	Ø120	240-270	1,7	SE522.927F	01 02 49
24,3	2700	2011	2370	95	x		24°	Ø120	240-270	1,7	SE522.927FD	01 02 49
24,3	2700	2011	2370	95		x	24°	Ø120	240-270	1,7	SE522.927FDF	01 02 49
24,3	2700	2095	2370	95			38°	Ø120	240-270	1,7	SE522.927W	01 02 49
24,3	2700	2095	2370	95	x		38°	Ø120	240-270	1,7	SE522.927WD	01 02 49
24,3	2700	2095	2370	95		x	38°	Ø120	240-270	1,7	SE522.927WDF	01 02 49
24,3	3000	2045	2545	95			15°	Ø120	240-270	1,7	SE522.930S	01 02 49
24,3	3000	2045	2545	95	x		15°	Ø120	240-270	1,7	SE522.930SD	01 02 49
24,3	3000	2045	2545	95		x	15°	Ø120	240-270	1,7	SE522.930SDF	01 02 49
24,3	3000	2160	2545	95			24°	Ø120	240-270	1,7	SE522.930F	01 02 49
24,3	3000	2160	2545	95	x		24°	Ø120	240-270	1,7	SE522.930FD	01 02 49
24,3	3000	2160	2545	95		x	24°	Ø120	240-270	1,7	SE522.930FDF	01 02 49
24,3	3000	2250	2545	95			38°	Ø120	240-270	1,7	SE522.930W	01 02 49
24,3	3000	2250	2545	95	x		38°	Ø120	240-270	1,7	SE522.930WD	01 02 49
24,3	3000	2250	2545	95		x	38°	Ø120	240-270	1,7	SE522.930WDF	01 02 49
24,3	4000	2250	2800	95			15°	Ø120	240-270	1,7	SE522.940S	01 02 49
24,3	4000	2250	2800	95	x		15°	Ø120	240-270	1,7	SE522.940SD	01 02 49
24,3	4000	2250	2800	95		x	15°	Ø120	240-270	1,7	SE522.940SDF	01 02 49
24,3	4000	2376	2800	95			24°	Ø120	240-270	1,7	SE522.940F	01 02 49
24,3	4000	2376	2800	95	x		24°	Ø120	240-270	1,7	SE522.940FD	01 02 49
24,3	4000	2376	2800	95		x	24°	Ø120	240-270	1,7	SE522.940FDF	01 02 49
24,3	4000	2475	2800	95			38°	Ø120	240-270	1,7	SE522.940W	01 02 49
24,3	4000	2475	2800	95	x		38°	Ø120	240-270	1,7	SE522.940WD	01 02 49
24,3	4000	2475	2800	95		x	38°	Ø120	240-270	1,7	SE522.940WDF	01 02 49
375	2700	2547	3530	95			15°	Ø120	240-270	1,7	SE523.927S	01 02 49
375	2700	2547	3530	95	x		15°	Ø120	240-270	1,7	SE523.927SD	01 02 49
375	2700	2692	3530	95			24°	Ø120	240-270	1,7	SE523.927F	01 02 49
375	2700	2692	3530	95	x		24°	Ø120	240-270	1,7	SE523.927FD	01 02 49
375	2700	2817	3530	95			38°	Ø120	240-270	1,7	SE523.927W	01 02 49
375	2700	2817	3530	95	x		38°	Ø120	240-270	1,7	SE523.927WD	01 02 49
375	3000	2731	3785	95			15°	Ø120	240-270	1,7	SE523.930S	01 02 49
375	3000	2731	3785	95	x		15°	Ø120	240-270	1,7	SE523.930SD	01 02 49
375	3000	2886	3785	95			24°	Ø120	240-270	1,7	SE523.930F	01 02 49
375	3000	2886	3785	95	x		24°	Ø120	240-270	1,7	SE523.930FD	01 02 49
375	3000	3020	3785	95			38°	Ø120	240-270	1,7	SE523.930W	01 02 49
375	3000	3020	3785	95	x		38°	Ø120	240-270	1,7	SE523.930WD	01 02 49
375	4000	2998	4155	95			15°	Ø120	240-270	1,7	SE523.940S	01 02 49
375	4000	2998	4155	95	x		15°	Ø120	240-270	1,7	SE523.940SD	01 02 49
375	4000	3168	4155	95			24°	Ø120	240-270	1,7	SE523.940F	01 02 49
375	4000	3168	4155	95	x		24°	Ø120	240-270	1,7	SE523.940FD	01 02 49
375	4000	3315	4155	95			38°	Ø120	240-270	1,7	SE523.940W	01 02 49
375	4000	3315	4155	95	x		38°	Ø120	240-270	1,7	SE523.940WD	01 02 49





## RIFLETTORI

REFLECTOR - REFLECTOR



Optic	Dim.	Kg	CODE	Col.
15°	Ø 85	0,05	R085S.A	01 02
24°	Ø 85	0,05	R085FA	01 02
38°	Ø 85	0,05	R085W.A	01 02
15°	Ø 115	0,05	R115S.A	01 02
24°	Ø 115	0,05	R115FA	01 02
38°	Ø 115	0,05	R115W.A	01 02



## LENTI

LENSES - LENTES



ANELLO CON LENTE SATINATA / SATIN LENS WITH RING / ANILLO CON LENTE SATINADA

Dim.	Kg	CODE	Col.
Ø 85	0,02	L085S.A	01 02
Ø 115	0,02	L115S.A	01 02



ANELLO CON LENTE FRESNEL / FRESNEL LENS WITH RING / ANILLO CON LENTE FRESNEL

Dim.	Kg	CODE	Col.
Ø 85	0,02	L085FA	01 02
Ø 115	0,02	L115FA	01 02



ANELLO CON LENTE ELISSOIDALE / ELIPSOID LENS WITH RING / ANILLO CON LENTE ELIPSOIDAL

Dim.	Kg	CODE	Col.
Ø 85	0,02	L085E.A	01 02
Ø 115	0,02	L115E.A	01 02



ANELLO CON LENTE ASIMMETRICA / ASYMMETRIC LENS WITH RING / ANILLO CON LENTE ASIMÉTRICA

Dim.	Kg	CODE	Col.
Ø 85	0,02	L085A.A	01 02
Ø 115	0,02	L115A.A	01 02



FILTRO NIDO DAPE / HONEY COMB LOUVER WITH RING / ANILLO CON REJILLA DE NIDO DE ABEJA

Dim.	Kg	CODE	Col.
Ø 85	0,02	L085RA	01 02
Ø 115	0,02	L115RA	01 02



01 - bianco - white - blanco

02 - nero - black - negro



RUOTE DA SOGNO REGGIO EMILIA - ITALY  
PROJECT ARCH. ANDREA OLIVA  
PHOTO KAI UWE SCHULTE BUNERC

---

Proiettore professionale da binario Eurostandard 230V o da parete-soffitto, orientabile, completo di sorgente LED disponibile nelle versioni 2700K- 3000K- 4000K con ottiche da 15°- 24°- 38° intercambiabili Twist & Lock, anche in versione dimmerabile dali e dimmerabile taglio di fase. Versioni a binario complete di adattatore Eurostandard. Adattatore compatibile con binari One Track (A.A.G. Stucchi ) o Global Track pulse (Nordic Aluminium). Corpo e gruppo ottico di sezione cilindrica in estruso di alluminio verniciato. Snodi meccanici in acciaio. Orientabilità del gruppo ottico dalla posizione di riposo verticale di 355° sull'asse verticale  $\pm 90^\circ$  su quello orizzontale.

Professional projectors for 230V Eurostandard track or for ceiling-wall installation. Complete with professional LED source 2700K, 3000K e 4000K; optic 15°, 24° e 38° interchangeable Twist & Lock, also available in Dali or trailing/leading edge dimmable version. Compatible with track One Track (A.A.G. Stucchi ) or Global Track pulse (Nordic Aluminium). Track versions supplied complete with euro- adaptor. Cylindrical body and optical group in painted extruded aluminium. Mechanical joints steel-made. Optical group 355° vertically and +/- 90° horizontally adjustable.

Proyectors para raíl Eurostandard 230V o para pared y techo orientables con LED profesiones 2700K - 3000K - 4000K, optic 15°,24°,38° intercambiabile Twist & Lock y version dimmable. Versiones a raíl con adaptator Eurostandard. Versione dimmable Dali. Se puede usar en el binario OneTrack (A.A.G. Stucchi ) or GlobalTrack pulse (Nordic Aluminium). Cuerpo y grupo óptico en estruso de aluminio pintado. Codos mecánicos en acero. Grupo óptico orientable 355° sobre el eje vertical y de +/- 90° sobre le horizontal.

---



PHAR TRACK



PALAZZO DEI DIAMANTI - FERRARA ITALY  
PHOTO D.ZAGHI





## PHAR 90 BINARIO

TRACK PROJECTOR - PRYECTORE POR CARRIL

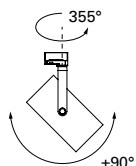
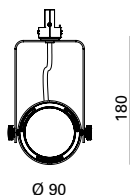
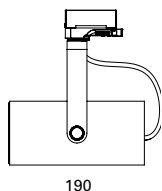

LED	W	K	lm product	lm/Led	CRI	Dali	DimTF	∠	Dim.	H	Kg	CODE	Col.
	17	2700	1438	1790	95			15°	ø90	190	1,2	PH001.927S	01 02 49
	17	2700	1438	1790	95	x		15°	ø90	190	1,2	PH001.927SD	01 02 49
	17	2700	1438	1790	95		x	15°	ø90	190	1,2	PH001.927SDF	01 02 49
	17	2700	1530	1790	95			24°	ø90	190	1,2	PH001.927F	01 02 49
	17	2700	1530	1790	95	x		24°	ø90	190	1,2	PH001.927FD	01 02 49
	17	2700	1530	1790	95		x	24°	ø90	190	1,2	PH001.927FDF	01 02 49
	17	2700	1609	1790	95			38°	ø90	190	1,2	PH001.927W	01 02 49
	17	2700	1609	1790	95	x		38°	ø90	190	1,2	PH001.927WD	01 02 49
	17	2700	1609	1790	95		x	38°	ø90	190	1,2	PH001.927WDF	01 02 49
	17	3000	1546	1925	95			15°	ø90	190	1,2	PH001.930S	01 02 49
	17	3000	1546	1925	95	x		15°	ø90	190	1,2	PH001.930SD	01 02 49
	17	3000	1546	1925	95		x	15°	ø90	190	1,2	PH001.930SDF	01 02 49
	17	3000	1645	1925	95			24°	ø90	190	1,2	PH001.930F	01 02 49
	17	3000	1645	1925	95	x		24°	ø90	190	1,2	PH001.930FD	01 02 49
	17	3000	1645	1925	95		x	24°	ø90	190	1,2	PH001.930FDF	01 02 49
	17	3000	1730	1925	95			38°	ø90	190	1,2	PH001.930W	01 02 49
	17	3000	1730	1925	95	x		38°	ø90	190	1,2	PH001.930WD	01 02 49
	17	3000	1730	1925	95		x	38°	ø90	190	1,2	PH001.930WDF	01 02 49
	17	4000	1699	2115	95			15°	ø90	190	1,2	PH001.940S	01 02 49
	17	4000	1699	2115	95	x		15°	ø90	190	1,2	PH001.940SD	01 02 49
	17	4000	1699	2115	95		x	15°	ø90	190	1,2	PH001.940SDF	01 02 49
	17	4000	1807	2115	95			24°	ø90	190	1,2	PH001.940F	01 02 49
	17	4000	1807	2115	95	x		24°	ø90	190	1,2	PH001.940FD	01 02 49
	17	4000	1807	2115	95		x	24°	ø90	190	1,2	PH001.940FDF	01 02 49
	17	4000	1901	2115	95			38°	ø90	190	1,2	PH001.940W	01 02 49
	17	4000	1901	2115	95	x		38°	ø90	190	1,2	PH001.940WD	01 02 49
	17	4000	1901	2115	95		x	38°	ø90	190	1,2	PH001.940WDF	01 02 49
	24,3	2700	1904	2370	95			15°	ø90	190	1,2	PH004.927S	01 02 49
	24,3	2700	1904	2370	95	x		15°	ø90	190	1,2	PH004.927SD	01 02 49
	24,3	2700	1904	2370	95		x	15°	ø90	190	1,2	PH004.927SDF	01 02 49
	24,3	2700	2011	2370	95			24°	ø90	190	1,2	PH004.927F	01 02 49
	24,3	2700	2011	2370	95	x		24°	ø90	190	1,2	PH004.927FD	01 02 49
	24,3	2700	2011	2370	95		x	24°	ø90	190	1,2	PH004.927FDF	01 02 49
	24,3	2700	2095	2370	95			38°	ø90	190	1,2	PH004.927W	01 02 49
	24,3	2700	2095	2370	95	x		38°	ø90	190	1,2	PH004.927WD	01 02 49
	24,3	2700	2095	2370	95		x	38°	ø90	190	1,2	PH004.927WDF	01 02 49
	24,3	3000	2045	2545	95			15°	ø90	190	1,2	PH004.930S	01 02 49
	24,3	3000	2045	2545	95	x		15°	ø90	190	1,2	PH004.930SD	01 02 49
	24,3	3000	2045	2545	95		x	15°	ø90	190	1,2	PH004.930SDF	01 02 49
	24,3	3000	2160	2545	95			24°	ø90	190	1,2	PH004.930F	01 02 49
	24,3	3000	2160	2545	95	x		24°	ø90	190	1,2	PH004.930FD	01 02 49
	24,3	3000	2160	2545	95		x	24°	ø90	190	1,2	PH004.930FDF	01 02 49
	24,3	3000	2250	2545	95			38°	ø90	190	1,2	PH004.930W	01 02 49
	24,3	3000	2250	2545	95	x		38°	ø90	190	1,2	PH004.930WD	01 02 49
	24,3	3000	2250	2545	95		x	38°	ø90	190	1,2	PH004.930WDF	01 02 49
	24,3	4000	2250	2800	95			15°	ø90	190	1,2	PH004.940S	01 02 49
	24,3	4000	2250	2800	95	x		15°	ø90	190	1,2	PH004.940SD	01 02 49
	24,3	4000	2250	2800	95		x	15°	ø90	190	1,2	PH004.940SDF	01 02 49
	24,3	4000	2376	2800	95			24°	ø90	190	1,2	PH004.940F	01 02 49
	24,3	4000	2376	2800	95	x		24°	ø90	190	1,2	PH004.940FD	01 02 49
	24,3	4000	2376	2800	95		x	24°	ø90	190	1,2	PH004.940FDF	01 02 49
	24,3	4000	2475	2800	95			38°	ø90	190	1,2	PH004.940W	01 02 49
	24,3	4000	2475	2800	95	x		38°	ø90	190	1,2	PH004.940WD	01 02 49
	24,3	4000	2475	2800	95		x	38°	ø90	190	1,2	PH004.940WDF	01 02 49

Dali : Versione dimmerabile Dali. Adattatore compatibile con binari One Track (A.A.G. Stucchi ) o Global Track pulse (Nordic Aluminium)/ Dimmable Dali version. For connection to the One Track (A.A.G. Stucchi ) or Global Track pulse (Nordic Aluminium)/ Versione dimmerabile Dali. Se puede usar en el binario One Track (A.A.G. Stucchi ) or Global Track pulse (Nordic Aluminium)

DimTF: Versione dimmerabile taglio di fase / Trailing/leading edge dimmable version / Versione dimmable corte de fase.



accessori - accessories  
accesorios pag. 603





## PHAR 120 BINARIO

TRACK PROJECTOR - PRYECTORE POR CARRIL



LED

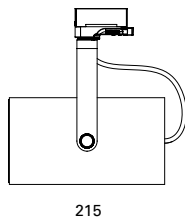

215

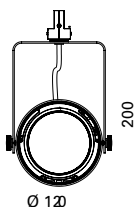

Ø 120

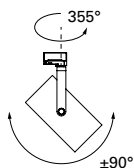

355°

±90°



accessori - accessories  
accesorios pag. 603

3SDCM  
50000h  
L90 B10 ta  
25°

A+

W	K	lm product	lm/Led	CRI	Dali	DimTF	∠	Dim.	H	Kg	CODE	Col.
17	2700	1438	1790	95			15°	Ø120	215	1,4	PH101.927S	01 02 49
17	2700	1438	1790	95	x		15°	Ø120	215	1,4	PH101.927SD	01 02 49
17	2700	1438	1790	95		x	15°	Ø120	215	1,4	PH101.927SDF	01 02 49
17	2700	1530	1790	95			24°	Ø120	215	1,4	PH101.927F	01 02 49
17	2700	1530	1790	95	x		24°	Ø120	215	1,4	PH101.927FD	01 02 49
17	2700	1530	1790	95		x	24°	Ø120	215	1,4	PH101.927FDF	01 02 49
17	2700	1609	1790	95			38°	Ø120	215	1,4	PH101.927W	01 02 49
17	2700	1609	1790	95	x		38°	Ø120	215	1,4	PH101.927WD	01 02 49
17	2700	1609	1790	95		x	38°	Ø120	215	1,4	PH101.927WDF	01 02 49
17	3000	1546	1925	95			15°	Ø120	215	1,4	PH101.930S	01 02 49
17	3000	1546	1925	95	x		15°	Ø120	215	1,4	PH101.930SD	01 02 49
17	3000	1546	1925	95		x	15°	Ø120	215	1,4	PH101.930SDF	01 02 49
17	3000	1645	1925	95			24°	Ø120	215	1,4	PH101.930F	01 02 49
17	3000	1645	1925	95	x		24°	Ø120	215	1,4	PH101.930FD	01 02 49
17	3000	1645	1925	95		x	24°	Ø120	215	1,4	PH101.930FDF	01 02 49
17	3000	1730	1925	95			38°	Ø120	215	1,4	PH101.930W	01 02 49
17	3000	1730	1925	95	x		38°	Ø120	215	1,4	PH101.930WD	01 02 49
17	3000	1730	1925	95		x	38°	Ø120	215	1,4	PH101.930WDF	01 02 49
17	4000	1699	2115	95			15°	Ø120	215	1,4	PH101.940S	01 02 49
17	4000	1699	2115	95	x		15°	Ø120	215	1,4	PH101.940SD	01 02 49
17	4000	1699	2115	95		x	15°	Ø120	215	1,4	PH101.940SDF	01 02 49
17	4000	1807	2115	95			24°	Ø120	215	1,4	PH101.940F	01 02 49
17	4000	1807	2115	95	x		24°	Ø120	215	1,4	PH101.940FD	01 02 49
17	4000	1807	2115	95		x	24°	Ø120	215	1,4	PH101.940FDF	01 02 49
17	4000	1901	2115	95			38°	Ø120	215	1,4	PH101.940W	01 02 49
17	4000	1901	2115	95	x		38°	Ø120	215	1,4	PH101.940WD	01 02 49
17	4000	1901	2115	95		x	38°	Ø120	215	1,4	PH101.940WDF	01 02 49
24,3	2700	1904	2370	95			15°	Ø120	215	1,6	PH104.927S	01 02 49
24,3	2700	1904	2370	95	x		15°	Ø120	215	1,6	PH104.927SD	01 02 49
24,3	2700	1904	2370	95		x	15°	Ø120	215	1,6	PH104.927SDF	01 02 49
24,3	2700	2011	2370	95			24°	Ø120	215	1,6	PH104.927F	01 02 49
24,3	2700	2011	2370	95	x		24°	Ø120	215	1,6	PH104.927FD	01 02 49
24,3	2700	2011	2370	95		x	24°	Ø120	215	1,6	PH104.927FDF	01 02 49
24,3	2700	2095	2370	95			38°	Ø120	215	1,6	PH104.927W	01 02 49
24,3	2700	2095	2370	95	x		38°	Ø120	215	1,6	PH104.927WD	01 02 49
24,3	2700	2095	2370	95		x	38°	Ø120	215	1,6	PH104.927WDF	01 02 49
24,3	3000	2045	2545	95			15°	Ø120	215	1,6	PH104.930S	01 02 49
24,3	3000	2045	2545	95	x		15°	Ø120	215	1,6	PH104.930SD	01 02 49
24,3	3000	2045	2545	95		x	15°	Ø120	215	1,6	PH104.930SDF	01 02 49
24,3	3000	2160	2545	95			24°	Ø120	215	1,6	PH104.930F	01 02 49
24,3	3000	2160	2545	95	x		24°	Ø120	215	1,6	PH104.930FD	01 02 49
24,3	3000	2160	2545	95		x	24°	Ø120	215	1,6	PH104.930FDF	01 02 49
24,3	3000	2250	2545	95			38°	Ø120	215	1,6	PH104.930W	01 02 49
24,3	3000	2250	2545	95	x		38°	Ø120	215	1,6	PH104.930WD	01 02 49
24,3	3000	2250	2545	95		x	38°	Ø120	215	1,6	PH104.930WDF	01 02 49
24,3	4000	2250	2800	95			15°	Ø120	215	1,6	PH104.940S	01 02 49
24,3	4000	2250	2800	95	x		15°	Ø120	215	1,6	PH104.940SD	01 02 49
24,3	4000	2250	2800	95		x	15°	Ø120	215	1,6	PH104.940SDF	01 02 49
24,3	4000	2376	2800	95			24°	Ø120	215	1,6	PH104.940F	01 02 49
24,3	4000	2376	2800	95	x		24°	Ø120	215	1,6	PH104.940FD	01 02 49
24,3	4000	2376	2800	95		x	24°	Ø120	215	1,6	PH104.940FDF	01 02 49
24,3	4000	2475	2800	95			38°	Ø120	215	1,6	PH104.940W	01 02 49
24,3	4000	2475	2800	95	x		38°	Ø120	215	1,6	PH104.940WD	01 02 49
24,3	4000	2475	2800	95		x	38°	Ø120	215	1,6	PH104.940WDF	01 02 49
37,5	2700	2547	3530	95			15°	Ø120	215	1,7	PH107.927S	01 02 49
37,5	2700	2547	3530	95	x		15°	Ø120	215	1,7	PH107.927SD	01 02 49
37,5	2700	2692	3530	95			24°	Ø120	215	1,7	PH107.927F	01 02 49
37,5	2700	2692	3530	95	x		24°	Ø120	215	1,7	PH107.927FD	01 02 49
37,5	2700	2817	3530	95			38°	Ø120	215	1,7	PH107.927W	01 02 49
37,5	2700	2817	3530	95	x		38°	Ø120	215	1,7	PH107.927WD	01 02 49
37,5	2700	2817	3530	95		x	38°	Ø120	215	1,7	PH107.927WDF	01 02 49
37,5	3000	2731	3785	95			15°	Ø120	215	1,7	PH107.930S	01 02 49
37,5	3000	2731	3785	95	x		15°	Ø120	215	1,7	PH107.930SD	01 02 49
37,5	3000	2886	3785	95			24°	Ø120	215	1,7	PH107.930F	01 02 49
37,5	3000	2886	3785	95	x		24°	Ø120	215	1,7	PH107.930FD	01 02 49
37,5	3000	3020	3785	95			38°	Ø120	215	1,7	PH107.930W	01 02 49
37,5	3000	3020	3785	95	x		38°	Ø120	215	1,7	PH107.930WD	01 02 49
37,5	4000	2998	4155	95			15°	Ø120	215	1,7	PH107.940S	01 02 49
37,5	4000	2998	4155	95	x		15°	Ø120	215	1,7	PH107.940SD	01 02 49
37,5	4000	3168	4155	95			24°	Ø120	215	1,7	PH107.940F	01 02 49
37,5	4000	3168	4155	95	x		24°	Ø120	215	1,7	PH107.940FD	01 02 49
37,5	4000	3315	4155	95			38°	Ø120	215	1,7	PH107.940W	01 02 49
37,5	4000	3315	4155	95	x		38°	Ø120	215	1,7	PH107.940WD	01 02 49

PROJECTORS







---

**PHAR BASETTA**



# PHAR 90 PARETE/SOFFITTO

WALL/CEILING PROJECTOR - PROYECTOR PARED/TECHO



LED

W	K	lm product	lm/Led	CRI	Dali	DimTF	∠	Dim.	H	Kg	CODE	Col.
17	2700	1438	1790	95			15°	ø90	190	1,4	PH151.927S	01 02 49
17	2700	1438	1790	95	x		15°	ø90	190	1,4	PH151.927SD	01 02 49
17	2700	1438	1790	95		x	15°	ø90	190	1,4	PH151.927SDF	01 02 49
17	2700	1530	1790	95			24°	ø90	190	1,4	PH151.927F	01 02 49
17	2700	1530	1790	95	x		24°	ø90	190	1,4	PH151.927FD	01 02 49
17	2700	1530	1790	95		x	24°	ø90	190	1,4	PH151.927FDF	01 02 49
17	2700	1609	1790	95			38°	ø90	190	1,4	PH151.927W	01 02 49
17	2700	1609	1790	95	x		38°	ø90	190	1,4	PH151.927WD	01 02 49
17	2700	1609	1790	95		x	38°	ø90	190	1,4	PH151.927WDF	01 02 49
17	3000	1546	1925	95			15°	ø90	190	1,4	PH151.930S	01 02 49
17	3000	1546	1925	95	x		15°	ø90	190	1,4	PH151.930SD	01 02 49
17	3000	1546	1925	95		x	15°	ø90	190	1,4	PH151.930SDF	01 02 49
17	3000	1645	1925	95			24°	ø90	190	1,4	PH151.930F	01 02 49
17	3000	1645	1925	95	x		24°	ø90	190	1,4	PH151.930FD	01 02 49
17	3000	1645	1925	95		x	24°	ø90	190	1,4	PH151.930FDF	01 02 49
17	3000	1730	1925	95			38°	ø90	190	1,4	PH151.930W	01 02 49
17	3000	1730	1925	95	x		38°	ø90	190	1,4	PH151.930WD	01 02 49
17	3000	1730	1925	95		x	38°	ø90	190	1,4	PH151.930WDF	01 02 49
17	4000	1699	2115	95			15°	ø90	190	1,4	PH151.940S	01 02 49
17	4000	1699	2115	95	x		15°	ø90	190	1,4	PH151.940SD	01 02 49
17	4000	1699	2115	95		x	15°	ø90	190	1,4	PH151.940SDF	01 02 49
17	4000	1807	2115	95			24°	ø90	190	1,4	PH151.940F	01 02 49
17	4000	1807	2115	95	x		24°	ø90	190	1,4	PH151.940FD	01 02 49
17	4000	1807	2115	95		x	24°	ø90	190	1,4	PH151.940FDF	01 02 49
17	4000	1901	2115	95			38°	ø90	190	1,4	PH151.940W	01 02 49
17	4000	1901	2115	95	x		38°	ø90	190	1,4	PH151.940WD	01 02 49
17	4000	1901	2115	95		x	38°	ø90	190	1,4	PH151.940WDF	01 02 49
24,3	2700	1904	2370	95			15°	ø90	190	1,6	PH154.927S	01 02 49
24,3	2700	1904	2370	95	x		15°	ø90	190	1,6	PH154.927SD	01 02 49
24,3	2700	1904	2370	95		x	15°	ø90	190	1,6	PH154.927SDF	01 02 49
24,3	2700	2011	2370	95			24°	ø90	190	1,6	PH154.927F	01 02 49
24,3	2700	2011	2370	95	x		24°	ø90	190	1,6	PH154.927FD	01 02 49
24,3	2700	2011	2370	95		x	24°	ø90	190	1,6	PH154.927FDF	01 02 49
24,3	2700	2095	2370	95			38°	ø90	190	1,6	PH154.927W	01 02 49
24,3	2700	2095	2370	95	x		38°	ø90	190	1,6	PH154.927WD	01 02 49
24,3	2700	2095	2370	95		x	38°	ø90	190	1,6	PH154.927WDF	01 02 49
24,3	3000	2045	2545	95			15°	ø90	190	1,6	PH154.930S	01 02 49
24,3	3000	2045	2545	95	x		15°	ø90	190	1,6	PH154.930SD	01 02 49
24,3	3000	2045	2545	95		x	15°	ø90	190	1,6	PH154.930SDF	01 02 49
24,3	3000	2160	2545	95			24°	ø90	190	1,6	PH154.930F	01 02 49
24,3	3000	2160	2545	95	x		24°	ø90	190	1,6	PH154.930FD	01 02 49
24,3	3000	2160	2545	95		x	24°	ø90	190	1,6	PH154.930FDF	01 02 49
24,3	3000	2250	2545	95			38°	ø90	190	1,6	PH154.930W	01 02 49
24,3	3000	2250	2545	95	x		38°	ø90	190	1,6	PH154.930WD	01 02 49
24,3	3000	2250	2545	95		x	38°	ø90	190	1,6	PH154.930WDF	01 02 49
24,3	4000	2250	2800	95			15°	ø90	190	1,6	PH154.940S	01 02 49
24,3	4000	2250	2800	95	x		15°	ø90	190	1,6	PH154.940SD	01 02 49
24,3	4000	2250	2800	95		x	15°	ø90	190	1,6	PH154.940SDF	01 02 49
24,3	4000	2376	2800	95			24°	ø90	190	1,6	PH154.940F	01 02 49
24,3	4000	2376	2800	95	x		24°	ø90	190	1,6	PH154.940FD	01 02 49
24,3	4000	2376	2800	95		x	24°	ø90	190	1,6	PH154.940FDF	01 02 49
24,3	4000	2475	2800	95			38°	ø90	190	1,6	PH154.940W	01 02 49
24,3	4000	2475	2800	95	x		38°	ø90	190	1,6	PH154.940WD	01 02 49
24,3	4000	2475	2800	95		x	38°	ø90	190	1,6	PH154.940WDF	01 02 49

3SDCM  
50000h  
L90 B10 ta  
25°



Dali : Versione dimmerabile Dali / Dimmable Dali Touch&dim version / Versione dimmable  
DimTF: Versione dimmerabile Taglio di fase / Trailing/leading edge dimmable version / Versione  
dimmabile corte de fase.



accessori - accessories  
accesorios pag. 603

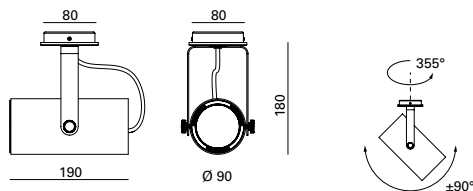

01 - bianco - white - blanco 02 - nero - black - negro 49 - moka - moka - moka

pag. 824



## PHAR 120 PARETE/SOFFITTO

WALL-CEILING PROJECTOR - PRYECTORE PARED/TECHO



LED

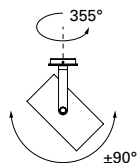
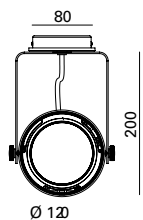
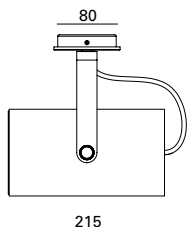

accessori - accessories  
accesorios pag. XXX

3SDCM  
50000h  
L90 B10 ta  
25° **A+**

W	K	Im product	Im/Led	CRI	Dali	DimTF	∠	Dim.	H	Kg	CODE	Col.
17	2700	1438	1790	95			15°	ø120	215	1,4	PH201.927S	01 02 49
17	2700	1438	1790	95	x		15°	ø120	215	1,4	PH201.927SD	01 02 49
17	2700	1438	1790	95		x	15°	ø120	215	1,4	PH201.927SDF	01 02 49
17	2700	1530	1790	95			24°	ø120	215	1,4	PH201.927F	01 02 49
17	2700	1530	1790	95	x		24°	ø120	215	1,4	PH201.927FD	01 02 49
17	2700	1530	1790	95		x	24°	ø120	215	1,4	PH201.927FDF	01 02 49
17	2700	1609	1790	95			38°	ø120	215	1,4	PH201.927W	01 02 49
17	2700	1609	1790	95	x		38°	ø120	215	1,4	PH201.927WD	01 02 49
17	2700	1609	1790	95		x	38°	ø120	215	1,4	PH201.927WDF	01 02 49
17	3000	1546	1925	95			15°	ø120	215	1,4	PH201.930S	01 02 49
17	3000	1546	1925	95	x		15°	ø120	215	1,4	PH201.930SD	01 02 49
17	3000	1546	1925	95		x	15°	ø120	215	1,4	PH201.930SDF	01 02 49
17	3000	1645	1925	95			24°	ø120	215	1,4	PH201.930F	01 02 49
17	3000	1645	1925	95	x		24°	ø120	215	1,4	PH201.930FD	01 02 49
17	3000	1645	1925	95		x	24°	ø120	215	1,4	PH201.930FDF	01 02 49
17	3000	1730	1925	95			38°	ø120	215	1,4	PH201.930W	01 02 49
17	3000	1730	1925	95	x		38°	ø120	215	1,4	PH201.930WD	01 02 49
17	3000	1730	1925	95		x	38°	ø120	215	1,4	PH201.930WDF	01 02 49
17	4000	1699	2115	95			15°	ø120	215	1,4	PH201.940S	01 02 49
17	4000	1699	2115	95	x		15°	ø120	215	1,4	PH201.940SD	01 02 49
17	4000	1699	2115	95		x	15°	ø120	215	1,4	PH201.940SDF	01 02 49
17	4000	1807	2115	95			24°	ø120	215	1,4	PH201.940F	01 02 49
17	4000	1807	2115	95	x		24°	ø120	215	1,4	PH201.940FD	01 02 49
17	4000	1807	2115	95		x	24°	ø120	215	1,4	PH201.940FDF	01 02 49
17	4000	1901	2115	95			38°	ø120	215	1,4	PH201.940W	01 02 49
17	4000	1901	2115	95	x		38°	ø120	215	1,4	PH201.940WD	01 02 49
17	4000	1901	2115	95		x	38°	ø120	215	1,4	PH201.940WDF	01 02 49
24,3	2700	1904	2370	95			15°	ø120	215	1,6	PH204.927S	01 02 49
24,3	2700	1904	2370	95	x		15°	ø120	215	1,6	PH204.927SD	01 02 49
24,3	2700	1904	2370	95		x	15°	ø120	215	1,6	PH204.927SDF	01 02 49
24,3	2700	2011	2370	95			24°	ø120	215	1,6	PH204.927F	01 02 49
24,3	2700	2011	2370	95	x		24°	ø120	215	1,6	PH204.927FD	01 02 49
24,3	2700	2011	2370	95		x	24°	ø120	215	1,6	PH204.927FDF	01 02 49
24,3	2700	2095	2370	95			38°	ø120	215	1,6	PH204.927W	01 02 49
24,3	2700	2095	2370	95	x		38°	ø120	215	1,6	PH204.927WD	01 02 49
24,3	2700	2095	2370	95		x	38°	ø120	215	1,6	PH204.927WDF	01 02 49
24,3	3000	2045	2545	95			15°	ø120	215	1,6	PH204.930S	01 02 49
24,3	3000	2045	2545	95	x		15°	ø120	215	1,6	PH204.930SD	01 02 49
24,3	3000	2045	2545	95		x	15°	ø120	215	1,6	PH204.930SDF	01 02 49
24,3	3000	2160	2545	95			24°	ø120	215	1,6	PH204.930F	01 02 49
24,3	3000	2160	2545	95	x		24°	ø120	215	1,6	PH204.930FD	01 02 49
24,3	3000	2160	2545	95		x	24°	ø120	215	1,6	PH204.930FDF	01 02 49
24,3	3000	2250	2545	95			38°	ø120	215	1,6	PH204.930W	01 02 49
24,3	3000	2250	2545	95	x		38°	ø120	215	1,6	PH204.930WD	01 02 49
24,3	3000	2250	2545	95		x	38°	ø120	215	1,6	PH204.930WDF	01 02 49
24,3	4000	2250	2800	95			15°	ø120	215	1,6	PH204.940S	01 02 49
24,3	4000	2250	2800	95	x		15°	ø120	215	1,6	PH204.940SD	01 02 49
24,3	4000	2250	2800	95		x	15°	ø120	215	1,6	PH204.940SDF	01 02 49
24,3	4000	2376	2800	95			24°	ø120	215	1,6	PH204.940F	01 02 49
24,3	4000	2376	2800	95	x		24°	ø120	215	1,6	PH204.940FD	01 02 49
24,3	4000	2376	2800	95		x	24°	ø120	215	1,6	PH204.940FDF	01 02 49
24,3	4000	2475	2800	95			38°	ø120	215	1,6	PH204.940W	01 02 49
24,3	4000	2475	2800	95	x		38°	ø120	215	1,6	PH204.940WD	01 02 49
24,3	4000	2475	2800	95		x	38°	ø120	215	1,6	PH204.940WDF	01 02 49
375	2700	2547	3530	95			15°	ø120	215	1,7	PH207.927S	01 02 49
375	2700	2547	3530	95	x		15°	ø120	215	1,7	PH207.927SD	01 02 49
375	2700	2692	3530	95			24°	ø120	215	1,7	PH207.927F	01 02 49
375	2700	2692	3530	95	x		24°	ø120	215	1,7	PH207.927FD	01 02 49
375	2700	2817	3530	95			38°	ø120	215	1,7	PH207.927W	01 02 49
375	2700	2817	3530	95	x		38°	ø120	215	1,7	PH207.927WD	01 02 49
375	3000	2731	3785	95			15°	ø120	215	1,7	PH207.930S	01 02 49
375	3000	2731	3785	95	x		15°	ø120	215	1,7	PH207.930SD	01 02 49
375	3000	2886	3785	95			24°	ø120	215	1,7	PH207.930F	01 02 49
375	3000	2886	3785	95	x		24°	ø120	215	1,7	PH207.930FD	01 02 49
375	3000	3020	3785	95			38°	ø120	215	1,7	PH207.930W	01 02 49
375	3000	3020	3785	95	x		38°	ø120	215	1,7	PH207.930WD	01 02 49
375	4000	2998	4155	95			15°	ø120	215	1,7	PH207.940S	01 02 49
375	4000	2998	4155	95	x		15°	ø120	215	1,7	PH207.940SD	01 02 49
375	4000	3168	4155	95			24°	ø120	215	1,7	PH207.940F	01 02 49
375	4000	3168	4155	95	x		24°	ø120	215	1,7	PH207.940FD	01 02 49
375	4000	3315	4155	95			38°	ø120	215	1,7	PH207.940W	01 02 49
375	4000	3315	4155	95	x		38°	ø120	215	1,7	PH207.940WD	01 02 49



## RIFLETTORI

REFLECTOR - REFLECTOR



Optic	Dim.	Kg	CODE	Col.
15°	Ø 85	0,05	R085S.A	01 02
24°	Ø 85	0,05	R085FA	01 02
38°	Ø 85	0,05	R085W.A	01 02
15°	Ø 115	0,05	R115S.A	01 02
24°	Ø 115	0,05	R115FA	01 02
38°	Ø 115	0,05	R115W.A	01 02

CE

## LENTI

LENSES - LENTES



ANELLO CON LENTE SATINATA / SATIN LENS WITH RING / ANILLO CON LENTE SATINADA

Dim.	Kg	CODE	Col.
Ø 85	0,02	L085S.A	01 02
Ø 115	0,02	L115S.A	

CE



ANELLO CON LENTE FRESNEL / FRESNEL LENS WITH RING / ANILLO CON LENTE FRESNEL

Dim.	Kg	CODE	Col.
Ø 85	0,02	L085FA	01 02
Ø 115	0,02	L115FA	

CE



ANELLO CON LENTE ELISSOIDALE / ELIPSOID LENS WITH RING / ANILLO CON LENTE ELIPSOIDAL

Dim.	Kg	CODE	Col.
Ø 85	0,02	L085EA	01 02
Ø 115	0,02	L115EA	

CE



ANELLO CON LENTE ASIMMETRICA / ASYMMETRIC LENS WITH RING / ANILLO CON LENTE ASIMÉTRICA

Dim.	Kg	CODE	Col.
Ø 85	0,02	L085AA	01 02
Ø 115	0,02	L115AA	

CE



FILTRO NIDO D'APE / HONEY COMB LOUVER WITH RING / ANILLO CON REJILLA DE NIDO DE ABEJA

Dim.	Kg	CODE	Col.
Ø 85	0,02	L085RA	01 02
Ø 115	0,02	L115RA	

CE



Proiettori professionali da binario Eurostandard 230V o parete e soffitto orientabili, completi di sorgenti LED professionali nelle seguenti versioni 2700K- 3000K- 4000K con ottiche da 15°- 24°- 38° intercambiabili Twist & Lock, o per lampade pre-focalizzate alogene/LED QR-LP 111, QPAR16. Completati di trasformatore 12V/230V o gruppo di alimentazione 230V/240V elettronici separati dal gruppo ottico per ottimizzazione della dissipazione del calore. Versioni a binario complete di adattatore. Adattatore compatibile con binari One Track (A.A.G. Stucchi ) o Global Track pulse (Nordic Aluminium). Corpo e gruppo ottico in estruso di alluminio verniciato. Snodi meccanici in acciaio. Gruppo Ottico orientabile 355° sull'asse orizzontale e da 0° a -90° su quello verticale. Versione diametro 55 per lampade pre-focalizzate dotata di sistema di Fast-Relamping a molla.

Professional projectors for 230V Eurostandard track or ceiling-wall installation. Complete with professional LED source 2700K, 3000K e 4000K; optic 15°, 24° e 38° interchangeable Twist & Lock, or for 12V/230V QR-LP 111, 230V QPAR16 halogen/LED. Complete with electronic 12V/230V transformer or 230V/240V control-gear box in separate housing for optimal heat dissipation. Track versions supplied complete with euro-adaptor. Track versions supplied with euro adaptor. Compatible with track One Track (A.A.G. Stucchi ) or Global Track pulse (Nordic Aluminium). Body and optical group in painted extruded aluminium. Mechanical joints steel made. Optical group 355° vertically and +/- 90° horizontally adjustable. 55 mm. diameter versions for pre-focused lamps equipped with Fast-Relamp System.

Proyectores profesionales para rail Eurostande 230V pared y techo orientables, con LED profesiones profesionales 2700K, 3000K y 4000K con óptica de 15°, 24°, 38° intercambiable Twist & Lock, o para lámparas prefocalizadas halógenas/LED QR-LP 111 12V/230V, QPAR16. Con transformador 12V/230V o grupo de alimentación electrónicos 230V/240V separados del grupo óptico para optimizar la dispersión del calor. Versiones para rail con adaptador incluido. Se puede usar en el binario One Track (A.A.G. Stucchi ) or Global Track pulse (Nordic Aluminium). Cuerpo y grupo óptico en estruso de aluminio pintado. Codos mecánicos en acero- Grupo óptico orientable 355° sobre el eje vertical y de 0° a 90° sobre le horizontal. Versiones de diámetro 55 para lámparas prefocalizadas dotadas de sistema "Fast-Relamping" con muelle.



PRO IN



PROJECTORS

## PRO IN FOCUS 55B BINARIO

TRACK PROJECTOR - PROYECTOR POR CARRIL

	QPAR16 GU10 230V	W	Dim.	H	CODE	Col.	
	1x LED / Halo max 50	1x LED / Halo max 50	ø55	125	PI001	01 02	

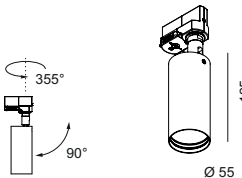

## PRO IN FOCUS 55V BINARIO

TRACK PROJECTOR - PROYECTOR POR CARRIL

	W	K	lm product	lm/Led	CRI	Dali	DimTF	∠	Dim.	H	CODE	Col.
	11	2700	931	1100	>90			29°	ø55	150	PI002.927S	01 02
	11	2700	931	1100	>90	x		29°	ø55	150	PI002.927SD	01 02
	11	2700	931	1100	>90		x	29°	ø55	150	PI002.927SDF	01 02
	11	2700	703	1100	>90			42°	ø55	150	PI002.927F	01 02
	11	2700	703	1100	>90	x		42°	ø55	150	PI002.927FD	01 02
	11	2700	703	1100	>90		x	42°	ø55	150	PI002.927FDF	01 02
	11	3000	1003	1185	>90			29°	ø55	150	PI002.930S	01 02
	11	3000	1003	1185	>90	x		29°	ø55	150	PI002.930SD	01 02
	11	3000	1003	1185	>90		x	29°	ø55	150	PI002.930SDF	01 02
	11	3000	757	1185	>90			42°	ø55	150	PI002.930F	01 02
	11	3000	757	1185	>90	x		42°	ø55	150	PI002.930FD	01 02
	11	3000	757	1185	>90		x	42°	ø55	150	PI002.930FDF	01 02
	11	4000	1088	1285	>90			29°	ø55	150	PI002.940S	01 02
	11	4000	1088	1285	>90	x		29°	ø55	150	PI002.940SD	01 02
	11	4000	1088	1285	>90		x	29°	ø55	150	PI002.940SDF	01 02
	11	4000	821	1285	>90			42°	ø55	150	PI002.940F	01 02
	11	4000	821	1285	>90	x		42°	ø55	150	PI002.940FD	01 02
	11	4000	821	1285	>90		x	42°	ø55	150	PI002.940FDF	01 02

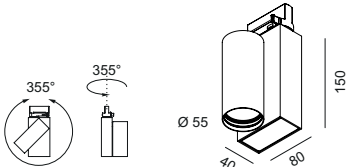

3SDCM  
 50000h L90  
 B10 ta 25°C



Dali : Versione dimmerabile Dali. Adattatore compatibile con binari One Track (A.A.G. Stucchi ) o Global Track pulse (Nordic Aluminium)/ Dimmable Dali version. For connection to the One Track (A.A.G. Stucchi ) or Global Track pulse (Nordic Aluminium)/ Versione dimmerabile Dali. Se puede usar en el binario One Track (A.A.G. Stucchi ) or Global Track pulse (Nordic Aluminium)  
 DimTF: Versione dimmerabile taglio di fase / Trailing/leading edge dimmable version / Versione dimmerabile corte de fase.

01 - bianco - white - blanco 02 - nero - black - negro

# PRO IN FOCUS 90V BINARIO

TRACK PROJECTOR - PROYECTOR POR CARRIL



LED

W	K	Im product	ImLed	CRI	Dali	DimTF	∠	Dim.	H	CODE	Col.
17	2700	1438	1790	95			15°	ø90	150	PI003.927S	01 02
17	2700	1438	1790	95	x		15°	ø90	150	PI003.927SD	01 02
17	2700	1438	1790	95		x	15°	ø90	150	PI003.927SDF	01 02
17	2700	1530	1790	95			24°	ø90	150	PI003.927F	01 02
17	2700	1530	1790	95	x		24°	ø90	150	PI003.927FD	01 02
17	2700	1530	1790	95		x	24°	ø90	150	PI003.927FDF	01 02
17	2700	1609	1790	95			38°	ø90	150	PI003.927W	01 02
17	2700	1609	1790	95	x		38°	ø90	150	PI003.927WD	01 02
17	2700	1609	1790	95		x	38°	ø90	150	PI003.927WDF	01 02
17	3000	1546	1925	95			15°	ø90	150	PI003.930S	01 02
17	3000	1546	1925	95	x		15°	ø90	150	PI003.930SD	01 02
17	3000	1546	1925	95		x	15°	ø90	150	PI003.930SDF	01 02
17	3000	1645	1925	95			24°	ø90	150	PI003.930F	01 02
17	3000	1645	1925	95	x		24°	ø90	150	PI003.930FD	01 02
17	3000	1645	1925	95		x	24°	ø90	150	PI003.930FDF	01 02
17	3000	1730	1925	95			38°	ø90	150	PI003.930W	01 02
17	3000	1730	1925	95	x		38°	ø90	150	PI003.930WD	01 02
17	3000	1730	1925	95		x	38°	ø90	150	PI003.930WDF	01 02
17	4000	1699	2115	95			15°	ø90	150	PI003.940S	01 02
17	4000	1699	2115	95	x		15°	ø90	150	PI003.940SD	01 02
17	4000	1699	2115	95		x	15°	ø90	150	PI003.940SDF	01 02
17	4000	1807	2115	95			24°	ø90	150	PI003.940F	01 02
17	4000	1807	2115	95	x		24°	ø90	150	PI003.940FD	01 02
17	4000	1807	2115	95		x	24°	ø90	150	PI003.940FDF	01 02
17	4000	1901	2115	95			38°	ø90	150	PI003.940W	01 02
17	4000	1901	2115	95	x		38°	ø90	150	PI003.940WD	01 02
17	4000	1901	2115	95		x	38°	ø90	150	PI003.940WDF	01 02
24,3	2700	1904	2370	95			15°	ø90	150	PI004.927S	01 02
24,3	2700	1904	2370	95	x		15°	ø90	150	PI004.927SD	01 02
24,3	2700	1904	2370	95		x	15°	ø90	150	PI004.927SDF	01 02
24,3	2700	2011	2370	95			24°	ø90	150	PI004.927F	01 02
24,3	2700	2011	2370	95	x		24°	ø90	150	PI004.927FD	01 02
24,3	2700	2011	2370	95		x	24°	ø90	150	PI004.927FDF	01 02
24,3	2700	2095	2370	95			38°	ø90	150	PI004.927W	01 02
24,3	2700	2095	2370	95	x		38°	ø90	150	PI004.927WD	01 02
24,3	2700	2095	2370	95		x	38°	ø90	150	PI004.927WDF	01 02
24,3	3000	2045	2545	95			15°	ø90	150	PI004.930S	01 02
24,3	3000	2045	2545	95	x		15°	ø90	150	PI004.930SD	01 02
24,3	3000	2045	2545	95		x	15°	ø90	150	PI004.930SDF	01 02
24,3	3000	2160	2545	95			24°	ø90	150	PI004.930F	01 02
24,3	3000	2160	2545	95	x		24°	ø90	150	PI004.930FD	01 02
24,3	3000	2160	2545	95		x	24°	ø90	150	PI004.930FDF	01 02
24,3	3000	2250	2545	95			38°	ø90	150	PI004.930W	01 02
24,3	3000	2250	2545	95	x		38°	ø90	150	PI004.930WD	01 02
24,3	3000	2250	2545	95		x	38°	ø90	150	PI004.930WDF	01 02
24,3	4000	2250	2800	95			15°	ø90	150	PI004.940S	01 02
24,3	4000	2250	2800	95	x		15°	ø90	150	PI004.940SD	01 02
24,3	4000	2250	2800	95		x	15°	ø90	150	PI004.940SDF	01 02
24,3	4000	2376	2800	95			24°	ø90	150	PI004.940F	01 02
24,3	4000	2376	2800	95	x		24°	ø90	150	PI004.940FD	01 02
24,3	4000	2376	2800	95		x	24°	ø90	150	PI004.940FDF	01 02
24,3	4000	2475	2800	95			38°	ø90	150	PI004.940W	01 02
24,3	4000	2475	2800	95	x		38°	ø90	150	PI004.940WD	01 02
24,3	4000	2475	2800	95		x	38°	ø90	150	PI004.940WDF	01 02

3SDCM  
50.000h  
L90 B10 ta  
25°

A+

Dali : Versione dimmerabile Dali. Adattatore compatibile con binari One Track (A.A.G. Stucchi ) o Global Track pulse (Nordic Aluminium)/ Dimmable Dali version. For connection to the One Track (A.A.G. Stucchi ) or Global Track pulse (Nordic Aluminium)/ Versione dimmabile Dali. Se puede usar en el binario One Track (A.A.G. Stucchi ) or Global Track pulse (Nordic Aluminium)  
DimTF: Versione dimmerabile taglio di fase / Trailing/leading edge dimmable version / Versione dimmabile corte de fase.



accessori - accessories  
accesorios pag. 615

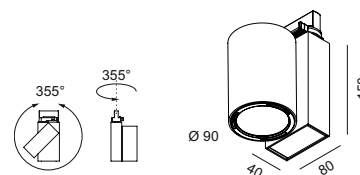

pag.824

01 - bianco - white - blanco 02 - nero - black - negro

## PRO IN FOCUS 900 BINARIO

TRACK PROJECTOR - PROYECTOR POR CARRIL



LED

W	K	lm product	lm/Led	CRI	Dali	DimTF	∠	Dim.	CODE	Col.
17	2700	1438	1790	95			15°	ø90	PI010.927S	01 02
17	2700	1438	1790	95	x		15°	ø90	PI010.927SD	01 02
17	2700	1438	1790	95		x	15°	ø90	PI010.927SDF	01 02
17	2700	1530	1790	95			24°	ø90	PI010.927F	01 02
17	2700	1530	1790	95	x		24°	ø90	PI010.927FD	01 02
17	2700	1530	1790	95		x	24°	ø90	PI010.927FDF	01 02
17	2700	1609	1790	95			38°	ø90	PI010.927W	01 02
17	2700	1609	1790	95	x		38°	ø90	PI010.927WD	01 02
17	2700	1609	1790	95		x	38°	ø90	PI010.927WDF	01 02
17	3000	1546	1925	95			15°	ø90	PI010.930S	01 02
17	3000	1546	1925	95	x		15°	ø90	PI010.930SD	01 02
17	3000	1546	1925	95		x	15°	ø90	PI010.930SDF	01 02
17	3000	1645	1925	95			24°	ø90	PI010.930F	01 02
17	3000	1645	1925	95	x		24°	ø90	PI010.930FD	01 02
17	3000	1645	1925	95		x	24°	ø90	PI010.930FDF	01 02
17	3000	1730	1925	95			38°	ø90	PI010.930W	01 02
17	3000	1730	1925	95	x		38°	ø90	PI010.930WD	01 02
17	3000	1730	1925	95		x	38°	ø90	PI010.930WDF	01 02
17	4000	1699	2115	95			15°	ø90	PI010.940S	01 02
17	4000	1699	2115	95	x		15°	ø90	PI010.940SD	01 02
17	4000	1699	2115	95		x	15°	ø90	PI010.940SDF	01 02
17	4000	1807	2115	95			24°	ø90	PI010.940F	01 02
17	4000	1807	2115	95	x		24°	ø90	PI010.940FD	01 02
17	4000	1807	2115	95		x	24°	ø90	PI010.940FDF	01 02
17	4000	1901	2115	95			38°	ø90	PI010.940W	01 02
17	4000	1901	2115	95	x		38°	ø90	PI010.940WD	01 02
17	4000	1901	2115	95		x	38°	ø90	PI010.940WDF	01 02
24,3	2700	1904	2370	95			15°	ø90	PI011.927S	01 02
24,3	2700	1904	2370	95	x		15°	ø90	PI011.927SD	01 02
24,3	2700	1904	2370	95		x	15°	ø90	PI011.927SDF	01 02
24,3	2700	2011	2370	95			24°	ø90	PI011.927F	01 02
24,3	2700	2011	2370	95	x		24°	ø90	PI011.927FD	01 02
24,3	2700	2011	2370	95		x	24°	ø90	PI011.927FDF	01 02
24,3	2700	2095	2370	95			38°	ø90	PI011.927W	01 02
24,3	2700	2095	2370	95	x		38°	ø90	PI011.927WD	01 02
24,3	2700	2095	2370	95		x	38°	ø90	PI011.927WDF	01 02
24,3	3000	2045	2545	95			15°	ø90	PI011.930S	01 02
24,3	3000	2045	2545	95	x		15°	ø90	PI011.930SD	01 02
24,3	3000	2045	2545	95		x	15°	ø90	PI011.930SDF	01 02
24,3	3000	2160	2545	95			24°	ø90	PI011.930F	01 02
24,3	3000	2160	2545	95	x		24°	ø90	PI011.930FD	01 02
24,3	3000	2160	2545	95		x	24°	ø90	PI011.930FDF	01 02
24,3	3000	2250	2545	95			38°	ø90	PI011.930W	01 02
24,3	3000	2250	2545	95	x		38°	ø90	PI011.930WD	01 02
24,3	3000	2250	2545	95		x	38°	ø90	PI011.930WDF	01 02
24,3	4000	2250	2800	95			15°	ø90	PI011.940S	01 02
24,3	4000	2250	2800	95	x		15°	ø90	PI011.940SD	01 02
24,3	4000	2250	2800	95		x	15°	ø90	PI011.940SDF	01 02
24,3	4000	2376	2800	95			24°	ø90	PI011.940F	01 02
24,3	4000	2376	2800	95	x		24°	ø90	PI011.940FD	01 02
24,3	4000	2376	2800	95		x	24°	ø90	PI011.940FDF	01 02
24,3	4000	2475	2800	95			38°	ø90	PI011.940W	01 02
24,3	4000	2475	2800	95	x		38°	ø90	PI011.940WD	01 02
24,3	4000	2475	2800	95		x	38°	ø90	PI011.940WDF	01 02

3SDCM  
50000h  
L90 B10 ta  
25°



Dali : Versione dimmerabile Dali. Adattatore compatibile con binari One Track (A.A.G. Stucchi ) o Global Track pulse (Nordic Aluminium)/ Dimmable Dali version. For connection to the One Track (A.A.G. Stucchi ) or Global Track pulse (Nordic Aluminium)/ Versione dimmabile Dali. Se puede usar en el binario One Track (A.A.G. Stucchi ) or Global Track pulse (Nordic Aluminium)  
DimTF: Versione dimmerabile taglio di fase / Trailing/leading edge dimmable version / Versione dimmable corte de fase.



accessori - accessories  
accessorios pag. 615

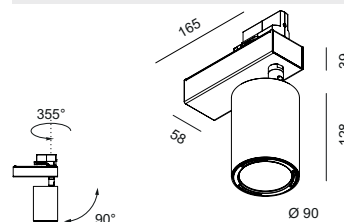

pag.824

01 - bianco - white - blanco 02 - nero - black - negro

# PRO IN 2 SPOTS BINARIO

TRACK PROJECTOR - PROYECTOR POR CARRIL



LED

3SDCM  
50000h L90  
B10 ta 25°C

A+

W	K	Im product	Im/Led	CRI	Dali	∠	Dim.	Lmm	CODE	Col.
2x17	2700	2875	3580	95		15°	ø90	480	PI012.927S	01 02
2x17	2700	2875	3580	95	x	15°	ø90	480	PI012.927SD	01 02
2x17	2700	3059	3580	95		24°	ø90	480	PI012.927F	01 02
2x17	2700	3059	3580	95	x	24°	ø90	480	PI012.927FD	01 02
2x17	2700	3217	3580	95		38°	ø90	480	PI012.927W	01 02
2x17	2700	3217	3580	95	x	38°	ø90	480	PI012.927WD	01 02
2x17	3000	3092	3850	95		15°	ø90	480	PI012.930S	01 02
2x17	3000	3092	3850	95	x	15°	ø90	480	PI012.930SD	01 02
2x17	3000	3290	3850	95		24°	ø90	480	PI012.930F	01 02
2x17	3000	3290	3850	95	x	24°	ø90	480	PI012.930FD	01 02
2x17	3000	3460	3850	95		38°	ø90	480	PI012.930W	01 02
2x17	3000	3460	3850	95	x	38°	ø90	480	PI012.930WD	01 02
2x24,3	2700	3809	4740	95		15°	ø90	480	PI013.927S	01 02
2x24,3	2700	3809	4740	95	x	15°	ø90	480	PI013.927SD	01 02
2x24,3	2700	4023	4740	95		24°	ø90	480	PI013.927F	01 02
2x24,3	2700	4023	4740	95	x	24°	ø90	480	PI013.927FD	01 02
2x24,3	2700	4190	4740	95		38°	ø90	480	PI013.927W	01 02
2x24,3	2700	4190	4740	95	x	38°	ø90	480	PI013.927WD	01 02
2x24,3	3000	4090	5090	95		15°	ø90	480	PI013.930S	01 02
2x24,3	3000	4090	5090	95	x	15°	ø90	480	PI013.930SD	01 02
2x24,3	3000	4320	5090	95		24°	ø90	480	PI013.930F	01 02
2x24,3	3000	4320	5090	95	x	24°	ø90	480	PI013.930FD	01 02
2x24,3	3000	4500	5090	95		38°	ø90	480	PI013.930W	01 02
2x24,3	3000	4500	5090	95	x	38°	ø90	480	PI013.930WD	01 02



Dali : Versione dimmerabile Dali. Adattatore compatibile con binari One Track (A.A.G. Stucchi ) o Global Track pulse (Nordic Aluminium)/ Dimmable Dali version. For connection to the One Track (A.A.G. Stucchi ) or Global Track pulse (Nordic Aluminium)/ Versione dimmabile Dali. Se puede usar en el binario One Track (A.A.G. Stucchi ) or Global Track pulse (Nordic Aluminium)



accessori - accessories  
accessorios pag. 615

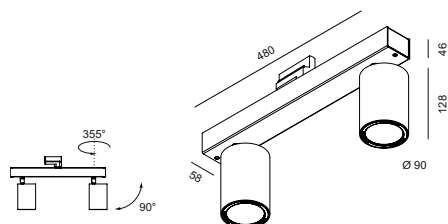

# PRO IN 3 SPOTS BINARIO

TRACK PROJECTOR - PROYECTOR POR CARRIL



LED

3SDCM  
50000h L90  
B10 ta 25°C

A+

W	K	lm product	lm/Led	CRI	Dali	∠	Dim.	L:mm	CODE	Col.
3x17	2700	4313	5370	95		15°	ø90	480	PI014.927S	01 02
3x17	2700	4313	5370	95	x	15°	ø90	480	PI014.927SD	01 02
3x17	2700	4589	5370	95		24°	ø90	480	PI014.927F	01 02
3x17	2700	4589	5370	95	x	24°	ø90	480	PI014.927FD	01 02
3x17	2700	4826	5370	95		38°	ø90	480	PI014.927W	01 02
3x17	2700	4826	5370	95	x	38°	ø90	480	PI014.927WD	01 02
3x17	3000	4638	5775	95		15°	ø90	480	PI014.930S	01 02
3x17	3000	4638	5775	95	x	15°	ø90	480	PI014.930SD	01 02
3x17	3000	4935	5775	95		24°	ø90	480	PI014.930F	01 02
3x17	3000	4935	5775	95	x	24°	ø90	480	PI014.930FD	01 02
3x17	3000	5190	5775	95		38°	ø90	480	PI014.930W	01 02
3x17	3000	5190	5775	95	x	38°	ø90	480	PI014.930WD	01 02
3x24,3	2700	5713	7110	95		15°	ø90	480	PI015.927S	01 02
3x24,3	2700	5713	7110	95	x	15°	ø90	480	PI015.927SD	01 02
3x24,3	2700	6034	7110	95		24°	ø90	480	PI015.927F	01 02
3x24,3	2700	6034	7110	95	x	24°	ø90	480	PI015.927FD	01 02
3x24,3	2700	6285	7110	95		38°	ø90	480	PI015.927W	01 02
3x24,3	2700	6285	7110	95	x	38°	ø90	480	PI015.927WD	01 02
3x24,3	3000	6135	7635	95		15°	ø90	480	PI015.930S	01 02
3x24,3	3000	6135	7635	95	x	15°	ø90	480	PI015.930SD	01 02
3x24,3	3000	6480	7635	95		24°	ø90	480	PI015.930F	01 02
3x24,3	3000	6480	7635	95	x	24°	ø90	480	PI015.930FD	01 02
3x24,3	3000	6749	7635	95		38°	ø90	480	PI015.930W	01 02
3x24,3	3000	6749	7635	95	x	38°	ø90	480	PI015.930WD	01 02



Dali : Versione dimmerabile Dali. Adattatore compatibile con binari One Track (A.A.G. Stucchi ) o Global Track pulse (Nordic Aluminium)/ Dimmable Dali version. For connection to the One Track (A.A.G. Stucchi ) or Global Track pulse (Nordic Aluminium)/ Versione dimmabile Dali. Se puede usar en el binario One Track (A.A.G. Stucchi ) or Global Track pulse (Nordic Aluminium)



accessori - accessories  
accessorios pag. 615

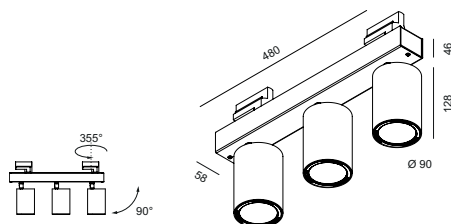



## PRO IN QR-LP111V BINARIO

TRACK PROJECTOR - PROYECTOR POR CARRIL



QR-LP 111 G53 12V	W 1x LED / Halo max 60	Dim. ø115	H 150	CODE PI005	Col. 01 02	
-------------------	---------------------------	--------------	----------	---------------	---------------	--

Il peso massimo consentito delle lampade LED QR-LP 111 sui nostri proiettori è di 275 g | The maximum allowed weight of 12V QR-LP 111 LED lamps is of 275 gr | El peso máximo admisible de las lámparas LED QR-LP 111 para nuestros proyectores es de 275gr

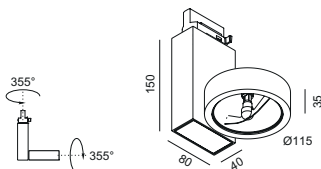

## PRO IN QR-LP1110 BINARIO

TRACK PROJECTOR - PROYECTOR POR CARRIL



QR-LP 111 G53 12V	W 1x LED / Halo max 60	Dim. ø111	H 145	CODE PI019	Col. 01 02	
-------------------	---------------------------	--------------	----------	---------------	---------------	--

Il peso massimo consentito delle lampade LED QR-LP 111 sui nostri proiettori è di 275 g | The maximum allowed weight of 12V QR-LP 111 LED lamps is of 275 gr - | El peso máximo admisible de las lámparas LED QR-LP 111 para nuestros proyectores es de 275gr

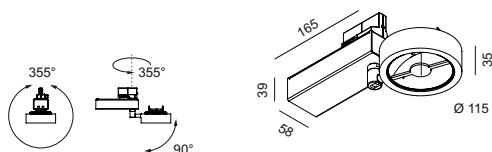

01 - bianco - white - blanco 02 - nero - black - negro

pag.824

## PRO IN FOCUS 90P PARETE/SOFFITTO

WALL/CEILING PROJECTOR- PROYECTOR PARED/TECHO



LED

W	K	lm product	lm/Led	CRI	Dali	DimTF	∠	Dim.	CODE	Col.
17	2700	1438	1790	95			15°	ø90	PI021.927S	01 02
17	2700	1438	1790	95	x		15°	ø90	PI021.927SD	01 02
17	2700	1438	1790	95		x	15°	ø90	PI021.927SDF	01 02
17	2700	1530	1790	95			24°	ø90	PI021.927F	01 02
17	2700	1530	1790	95	x		24°	ø90	PI021.927FD	01 02
17	2700	1530	1790	95		x	24°	ø90	PI021.927FDF	01 02
17	2700	1609	1790	95			38°	ø90	PI021.927W	01 02
17	2700	1609	1790	95	x		38°	ø90	PI021.927WD	01 02
17	2700	1609	1790	95		x	38°	ø90	PI021.927WDF	01 02
17	3000	1546	1925	95			15°	ø90	PI021.930S	01 02
17	3000	1546	1925	95	x		15°	ø90	PI021.930SD	01 02
17	3000	1546	1925	95		x	15°	ø90	PI021.930SDF	01 02
17	3000	1645	1925	95			24°	ø90	PI021.930F	01 02
17	3000	1645	1925	95	x		24°	ø90	PI021.930FD	01 02
17	3000	1645	1925	95		x	24°	ø90	PI021.930FDF	01 02
17	3000	1730	1925	95			38°	ø90	PI021.930W	01 02
17	3000	1730	1925	95	x		38°	ø90	PI021.930WD	01 02
17	3000	1730	1925	95		x	38°	ø90	PI021.930WDF	01 02
17	4000	1699	2115	95			15°	ø90	PI021.940S	01 02
17	4000	1699	2115	95	x		15°	ø90	PI021.940SD	01 02
17	4000	1699	2115	95		x	15°	ø90	PI021.940SDF	01 02
17	4000	1807	2115	95			24°	ø90	PI021.940F	01 02
17	4000	1807	2115	95	x		24°	ø90	PI021.940FD	01 02
17	4000	1807	2115	95		x	24°	ø90	PI021.940FDF	01 02
17	4000	1901	2115	95			38°	ø90	PI021.940W	01 02
17	4000	1901	2115	95	x		38°	ø90	PI021.940WD	01 02
17	4000	1901	2115	95		x	38°	ø90	PI021.940WDF	01 02
24,3	2700	1904	2370	95			15°	ø90	PI022.927S	01 02
24,3	2700	1904	2370	95	x		15°	ø90	PI022.927SD	01 02
24,3	2700	1904	2370	95		x	15°	ø90	PI022.927SDF	01 02
24,3	2700	2011	2370	95			24°	ø90	PI022.927F	01 02
24,3	2700	2011	2370	95	x		24°	ø90	PI022.927FD	01 02
24,3	2700	2011	2370	95		x	24°	ø90	PI022.927FDF	01 02
24,3	2700	2095	2370	95			38°	ø90	PI022.927W	01 02
24,3	2700	2095	2370	95	x		38°	ø90	PI022.927WD	01 02
24,3	2700	2095	2370	95		x	38°	ø90	PI022.927WDF	01 02
24,3	3000	2045	2545	95			15°	ø90	PI022.930S	01 02
24,3	3000	2045	2545	95	x		15°	ø90	PI022.930SD	01 02
24,3	3000	2045	2545	95		x	15°	ø90	PI022.930SDF	01 02
24,3	3000	2160	2545	95			24°	ø90	PI022.930F	01 02
24,3	3000	2160	2545	95	x		24°	ø90	PI022.930FD	01 02
24,3	3000	2160	2545	95		x	24°	ø90	PI022.930FDF	01 02
24,3	3000	2250	2545	95			38°	ø90	PI022.930W	01 02
24,3	3000	2250	2545	95	x		38°	ø90	PI022.930WD	01 02
24,3	3000	2250	2545	95		x	38°	ø90	PI022.930WDF	01 02
24,3	4000	2250	2800	95			15°	ø90	PI022.940S	01 02
24,3	4000	2250	2800	95	x		15°	ø90	PI022.940SD	01 02
24,3	4000	2250	2800	95		x	15°	ø90	PI022.940SDF	01 02
24,3	4000	2376	2800	95			24°	ø90	PI022.940F	01 02
24,3	4000	2376	2800	95	x		24°	ø90	PI022.940FD	01 02
24,3	4000	2376	2800	95		x	24°	ø90	PI022.940FDF	01 02
24,3	4000	2475	2800	95			38°	ø90	PI022.940W	01 02
24,3	4000	2475	2800	95	x		38°	ø90	PI022.940WD	01 02
24,3	4000	2475	2800	95		x	38°	ø90	PI022.940WDF	01 02

3SDCM  
50000h  
L90 B10 ta  
25°



Dali : Versione dimmerabile Dali / Dimmable Dali version / Versione dimmable Dali.  
DimTF: Versione dimmerabile Taglio di fase / Trailing/leading edge dimmable version / Versione dimmable corte de fase.

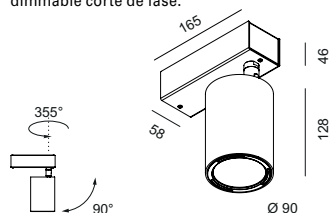

accessori - accessories  
accesorios pag. 615



# PRO IN FOCUS 90P 2 SPOTS PARETE/SOFFITTO

2SPOTS WALL/CEILING PROJECTORS - PARED/TECHO 2 SPOT



LED

3SDCM  
50000h L90  
B10 ta 25°C

A+

W	K	lm product	lm/Led	CRI	DalIT&D	∠	Dim.	Lmm	CODE	Col.
2x17	2700	2875	3580	95		15°	ø90	480	PI031.927S	01 02
2x17	2700	2875	3580	95	x	15°	ø90	480	PI031.927SD	01 02
2x17	2700	3059	3580	95		24°	ø90	480	PI031.927F	01 02
2x17	2700	3059	3580	95	x	24°	ø90	480	PI031.927FD	01 02
2x17	2700	3217	3580	95		38°	ø90	480	PI031.927W	01 02
2x17	2700	3217	3580	95	x	38°	ø90	480	PI031.927WD	01 02
2x17	3000	3092	3850	95		15°	ø90	480	PI031.930S	01 02
2x17	3000	3092	3850	95	x	15°	ø90	480	PI031.930SD	01 02
2x17	3000	3290	3850	95		24°	ø90	480	PI031.930F	01 02
2x17	3000	3290	3850	95	x	24°	ø90	480	PI031.930FD	01 02
2x17	3000	3460	3850	95		38°	ø90	480	PI031.930W	01 02
2x17	3000	3460	3850	95	x	38°	ø90	480	PI031.930WD	01 02
2x24,3	2700	3809	4740	95		15°	ø90	480	PI032.927S	01 02
2x24,3	2700	3809	4740	95	x	15°	ø90	480	PI032.927SD	01 02
2x24,3	2700	4023	4740	95		24°	ø90	480	PI032.927F	01 02
2x24,3	2700	4023	4740	95	x	24°	ø90	480	PI032.927FD	01 02
2x24,3	2700	4190	4740	95		38°	ø90	480	PI032.927W	01 02
2x24,3	2700	4190	4740	95	x	38°	ø90	480	PI032.927WD	01 02
2x24,3	3000	4090	5090	95		15°	ø90	480	PI032.930S	01 02
2x24,3	3000	4090	5090	95	x	15°	ø90	480	PI032.930SD	01 02
2x24,3	3000	4320	5090	95		24°	ø90	480	PI032.930F	01 02
2x24,3	3000	4320	5090	95	x	24°	ø90	480	PI032.930FD	01 02
2x24,3	3000	4500	5090	95		38°	ø90	480	PI032.930W	01 02
2x24,3	3000	4500	5090	95	x	38°	ø90	480	PI032.930WD	01 02

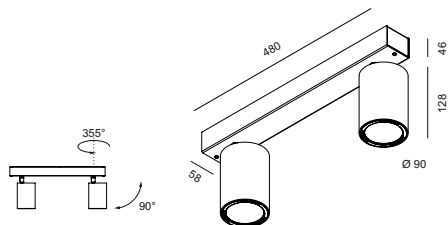

accessori - accessories  
accesorios pag. 615

PROJECTORS

01 - bianco - white - blanco 02 - nero - black - negro

pag.824

## PRO IN 3 SPOTS PARETE/SOFFITTO

3SPOTS WALL/CEILING PROJECTORS - PARED/TECHO 3 SPOT



LED

3SDCM  
50000h L90  
B10 ta 25°C

A+

W	K	Im product	Im/Led	CRI	DalIT&D	∠	Dim.	Lmm	CODE	Col.
3x17	2700	4313	5370	95		15°	ø90	480	PI033.927S	01 02
3x17	2700	4313	5370	95	x	15°	ø90	480	PI033.927SD	01 02
3x17	2700	4589	5370	95		24°	ø90	480	PI033.927F	01 02
3x17	2700	4589	5370	95	x	24°	ø90	480	PI033.927FD	01 02
3x17	2700	4826	5370	95		38°	ø90	480	PI033.927W	01 02
3x17	2700	4826	5370	95	x	38°	ø90	480	PI033.927WD	01 02
3x17	3000	4638	5775	95		15°	ø90	480	PI033.930S	01 02
3x17	3000	4638	5775	95	x	15°	ø90	480	PI033.930SD	01 02
3x17	3000	4935	5775	95		24°	ø90	480	PI033.930F	01 02
3x17	3000	4935	5775	95	x	24°	ø90	480	PI033.930FD	01 02
3x17	3000	5190	5775	95		38°	ø90	480	PI033.930W	01 02
3x17	3000	5190	5775	95	x	38°	ø90	480	PI033.930WD	01 02
3x24,3	2700	5713	7110	95		15°	ø90	480	PI034.927S	01 02
3x24,3	2700	5713	7110	95	x	15°	ø90	480	PI034.927SD	01 02
3x24,3	2700	6034	7110	95		24°	ø90	480	PI034.927F	01 02
3x24,3	2700	6034	7110	95	x	24°	ø90	480	PI034.927FD	01 02
3x24,3	2700	6285	7110	95		38°	ø90	480	PI034.927W	01 02
3x24,3	2700	6285	7110	95	x	38°	ø90	480	PI034.927WD	01 02
3x24,3	3000	6135	7635	95		15°	ø90	480	PI034.930S	01 02
3x24,3	3000	6135	7635	95	x	15°	ø90	480	PI034.930SD	01 02
3x24,3	3000	6480	7635	95		24°	ø90	480	PI034.930F	01 02
3x24,3	3000	6480	7635	95	x	24°	ø90	480	PI034.930FD	01 02
3x24,3	3000	6749	7635	95		38°	ø90	480	PI034.930W	01 02
3x24,3	3000	6749	7635	95	x	38°	ø90	480	PI034.930WD	01 02

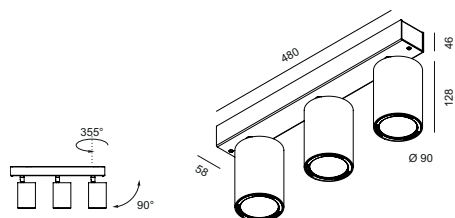

accessori - accessories  
acessorios pag. 615



## PRO IN QR-LP111P PARETE/SOFFITTO

QR-LP111P WALL/CEILING - PARED/TECHO



QR-LP 111 G53 12V



A+-D

W	Dim.	H	CODE	Col.
1x LED/ Halo max 60	ø111	145	PI023	01 02

Il peso massimo consentito delle lampade LED QR-LP 111 sui nostri proiettori è di 275 g | The maximum allowed weight of 12V QR-LP 111 LED lamps is of 275 gr | El peso máximo admisible de las lámparas LED QR-LP 111 para nuestros proyectores es de 275gr.

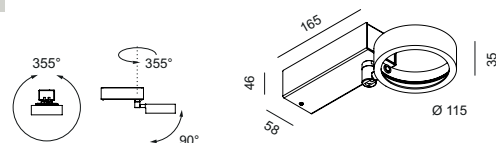

01 - bianco - white - blanco 02 - nero - black - negro

## RIFLETTORI

REFLECTOR - REFLECTOR



Optic	Dim.	Kg	CODE	Col.
15°	Ø 85	0,05	R085S.A	01 02
24°	Ø 85	0,05	R085FA	01 02
38°	Ø 85	0,05	R085W.A	01 02



lente - lentes - lentes

## LENTE CON ANELLO

LENSES WITH RING - LENTES CON ANILLO



LENTE SATINATA CON ANELLO / SATIN LENS WITH RING / LENTE SATINADA CON ANILLO

Dim.	Kg	CODE	Col.
Ø 85	0,02	L085S.A	01 02



LENTE FRESNEL CON ANELLO / FRESNEL LENS WITH RING / LENTE FRESNEL CON ANILLO

Dim.	Kg	CODE	Col.
Ø 85	0,02	L085FA	01 02



LENTE ELISSOIDALE CON ANELLO / ELIPSOID LENS WITH RING / LENTE ELIPSOIDAL CON ANILLO

Dim.	Kg	CODE	Col.
Ø 85	0,02	L085E.A	01 02



LENTE ASIMMETRICA CON ANELLO / ASYMMETRIC LENS WITH RING / LENTE ASIMÉTRICA CON ANILLO

Dim.	Kg	CODE	Col.
Ø 85	0,02	L085A.A	01 02



FILTRO NIDO D'APE CON ANELLO / HONEY COMB LOUVER WITH RING / REJILLA DE NIDO DE ABEJA CON ANILLO

Dim.	Kg	CODE	Col.
Ø 85	0,02	L085R.A	01 02



Proiettori professionali da parete, soffitto e binario Eurostandard 230V completo di sorgenti LED professionali o per lampade prefocalizzate alogene/LED QPAR16 o a ioduri metallici HI-PAR ESD50 230V/240V. Completi di trasformatore 12V/230V o gruppo di alimentazione 230V/240V elettronici separati dal gruppo ottico per ottimizzazione della dissipazione del calore. Versioni a binario complete di adattatore. Corpo e gruppo ottico in estruso di alluminio verniciato. Snodi meccanici in acciaio. Gruppo Ottico orientabile 355° sull'asse orizzontale e da 0° a -90° su quello verticale.

Professional projectors for 230V Eurostandard track or ceiling-wall installation. Complete with professional LED source or for 12V/230V QR-CB 51, 230V QPAR16 halogen/LED or 230V HI-PAR ESD50 metal halide lamps. Complete with electronic 12V/230V transformer or 230V/240V control-gear box in separate housing for optimal heat dissipation. Track versions supplied complete with euro adaptor. Body and optical group in painted extruded aluminium. Mechanical joints steel-made. Optical group 355° vertically and +/- 90° horizontally adjustable.

Proyectores profesionales para raíl Eurostandard 230V o para pared y techo orientables, con LED profesiones y preparados para lámparas prefocalizadas halógenas/LED QR-CB 51 12V/230V, QPAR16 o de yoduros metálicos HI-PAR ESD50 230V/240V. Con transformador 12V/230V o grupo de alimentación electrónicos 230V/240V separados del grupo óptico para optimizar la dispersión del calor. Versiones a raíl con adaptador Eurostandard. Cuerpo y grupo óptico en estruso de aluminio pintado. Codos mecánicos en acero. Grupo óptico orientable 355° sobre el eje vertical y de 0° a 90° sobre le horizontal.

---

**BI-CUBO**









---

## BI-CUBO RANGE



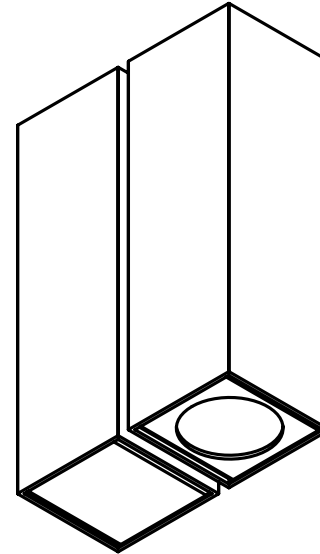
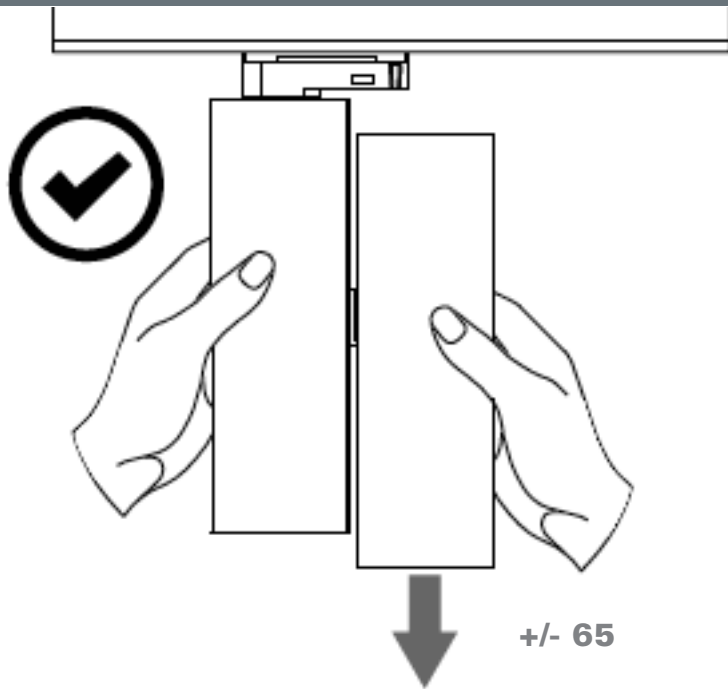

Gruppo Ottico orientabile 355° sull'asse orizzontale e da 0° a -90° su quello verticale.  
Optical group 355° vertically and +/- 90° horizontally adjustable.  
Grupo óptico orientable 355° sobre el eje vertical y de 0° a 90° sobre le horizontal.

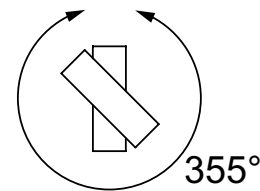
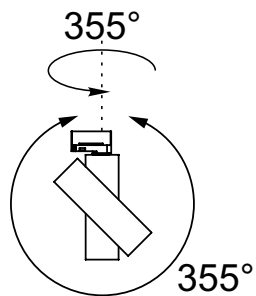



## BI-CUBO 190 PARETE/SOFFITTO

WALL/CEILING PROJECTOR - PARED Y TECHO



	W	K	lm product	lm/Led	CRI	∠	Dim.	H	Kg	CODE	Col.	
LED 3SDCM 50000h L90 B10 ta 25°C <b>A+</b>	11	2700	931	1100	>90	29°	60X60	190	1,00	<b>BC01.927S</b>	<b>01 02 29 39 49</b>	   
	11	2700	703	1100	>90	42°	60X60	190	1,00	<b>BC01.927F</b>	<b>01 02 29 39 49</b>	
	11	3000	1003	1185	>90	29°	60X60	190	1,00	<b>BC01.930S</b>	<b>01 02 29 39 49</b>	
	11	3000	757	1185	>90	42°	60X60	190	1,00	<b>BC01.930F</b>	<b>01 02 29 39 49</b>	
	11	4000	1088	1285	>90	29°	60X60	190	1,00	<b>BC01.940S</b>	<b>01 02 29 39 49</b>	
	11	4000	821	1285	>90	42°	60X60	190	1,00	<b>BC01.940F</b>	<b>01 02 29 39 49</b>	
QPAR16 GU10 230V <b>A+-D</b>	W						Dim.	H	Kg	CODE	Col.	  
	1x LED/Halo max 50						60X60	190	1,00	<b>BC05</b>	<b>01 02 29 39 49</b>	
HI-PAR ESD 50 GX10 <b>A</b>	W						Dim.	H	Kg	CODE	Col.	  
	1x max 35						60X60	190	1,00	<b>BC07</b>	<b>01 02 29 39 49</b>	

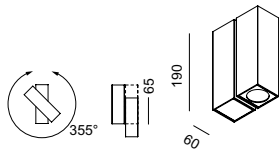

## BI-CUBO 190 BINARIO

TRACK PROJECTOR - CARRIL VERSION



	W	K	lm product	lm/Led	CRI	∠	Dim.	H	Kg	CODE	Col.	
LED 3SDCM 50000h L90 B10 ta 25°C <b>A+</b>	11	2700	931	1100	>90	29°	60X60	190	1,40	<b>BC30.927S</b>	<b>01 02 29 39 49</b>	   
	11	2700	703	1100	>90	42°	60X60	190	1,40	<b>BC30.927F</b>	<b>01 02 29 39 49</b>	
	11	3000	1003	1185	>90	29°	60X60	190	1,40	<b>BC30.930S</b>	<b>01 02 29 39 49</b>	
	11	3000	757	1185	>90	42°	60X60	190	1,40	<b>BC30.930F</b>	<b>01 02 29 39 49</b>	
	11	4000	1088	1285	>90	29°	60X60	190	1,40	<b>BC30.940S</b>	<b>01 02 29 39 49</b>	
	11	4000	821	1285	>90	42°	60X60	190	1,40	<b>BC30.940F</b>	<b>01 02 29 39 49</b>	
QPAR16 GU10 230V <b>A+-D</b>	W						Dim.	H	Kg	CODE	Col.	  
	1x LED/Halo max 50						60X60	190	1,40	<b>BC34</b>	<b>01 02 29 39 49</b>	
HI-PAR ESD 50 GX10 <b>A</b>	W						Dim.	H	Kg	CODE	Col.	  
	1x max 35						60X60	190	1,40	<b>BC36</b>	<b>01 02 29 39 49</b>	

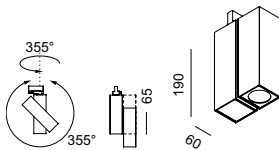

01 - bianco - white - blanco 02 - nero - black - negro 29 - cappuccino

39 - moka express

49 - moka - moka - moka

pag.824

Proiettori da parete o soffitto orientabili per lampade prefocalizzate LED o alogene QR-LP 111 e QR-CB 51 12V/230V. Completi di trasformatore 12V/230V o gruppo di alimentazione 230V/240V elettronici inclusi nella base di fissaggio. Base, asta e gruppo ottico in metallo finitura cromata o mista verniciata e cromata. Snodi di rotazione e particolari meccanici in acciaio finitura cromata. Orientabilità 355° sull'asse orizzontale e +/- 90° su quello verticale.

Wall and ceiling professional projectors for 12V/230V QR-LP 111 and QR-CB 51 LED/ halogen. Complete with electronic 12V/230V transformer or 230V/240V control-gear box included within the mounting base. Base, adjustable rod and optical group in chromed or chromed and painted metal. Joints and mechanical details in chromed steel. 355° horizontally and +/- 90° vertically adjustable.

Proyectoros de pared o techo orientables para lámparas prefocalizadas LED o halógenas QR-LP 111 y QR.CB 51 12V/230V. Con transformador 12V/230V o grupo de alimentación electrónicos 230V/240V incluidos en la base fijación. Base, brazo y grupo óptico en metal acabado cromado o pintado/cromado. Codos de rotación y detalles mecánicos en acero con acabado cromado. Orientabilidad de 355° sobre el eje horizontal y de 0° a 90° sobre le vertical.

---



**EXTENSOR**





RISTORANTE NETTUNO RIMINI - ITALY  
PROJECT ARCH. M. MORANDI  
PHOTO M. FLORES















ROCHE BOBOIS ROMA - ITALY  
PHOTO G. CONESE

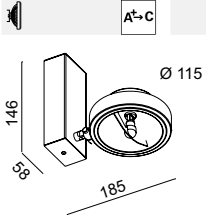



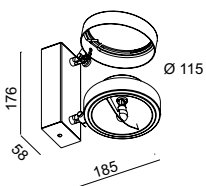

## EXTENSOR 1

	QR-LP 111 G53 12V	W 1x LED/Halo max 60	Kg 0.45	CODE LT1401	Col. 03 21 22 23 24	  
		<p>Compatibilità trasformatore 230V/12V con lampade LED. I trasformatore 230Vac/12Vac presentati in questo catalogo sono testati con i principali produttori di lampade LED. A causa della velocità dell'adeguamento tecnologico di queste ultime, Lucifero's non può garantire una compatibilità universale delle stesse con i propri trasformatore. Il peso massimo consentito delle lampade LED QR-LP 111 sui nostri proiettori è di 275 g.   230V/12V transformer's compatibility with LED lamps : the 230Vac/12Vac transformers presented on this catalogue have been tested with the leading LED lamps manufacturers. Due to the pace of the technological update of them, Lucifero's cannot guarantee their universal compatibility with its transformers. The maximum allowed weight of 12V QR-LP 111 LED lamps is of 275 gr.   Compatibilidad transformadores 230V/12V con lamparas LED: los transformadores 230Vac/12Vac presentados en este catálogo han sido testados con los principales productores de lámparas LED. Debido a la rápida evolución tecnológica de estas, Lucifero's no puede garantizar una compatibilidad universal de las mismas con nuestros transformadores. El peso máximo admisible de las lámparas LED QR-LP 111 para nuestros proyectores es de 275gr.</p>				

## EXTENSOR 2

	QR-LP 111 G53 12V	W 2x LED/Halo max 50	Kg 0.63	CODE LT1405	Col. 03 21 22 23 24	  
		<p>Compatibilità trasformatore 230V/12V con lampade LED. I trasformatore 230Vac/12Vac presentati in questo catalogo sono testati con i principali produttori di lampade LED. A causa della velocità dell'adeguamento tecnologico di queste ultime, Lucifero's non può garantire una compatibilità universale delle stesse con i propri trasformatore. Il peso massimo consentito delle lampade LED QR-LP 111 sui nostri proiettori è di 275 g.   230V/12V transformer's compatibility with LED lamps : the 230Vac/12Vac transformers presented on this catalogue have been tested with the leading LED lamps manufacturers. Due to the pace of the technological update of them, Lucifero's cannot guarantee their universal compatibility with its transformers. The maximum allowed weight of 12V QR-LP 111 LED lamps is of 275 gr.   Compatibilidad transformadores 230V/12V con lamparas LED: los transformadores 230Vac/12Vac presentados en este catálogo han sido testados con los principales productores de lámparas LED. Debido a la rápida evolución tecnológica de estas, Lucifero's no puede garantizar una compatibilidad universal de las mismas con nuestros transformadores. El peso máximo admisible de las lámparas LED QR-LP 111 para nuestros proyectores es de 275gr.</p>				

## EXTENSOR 1C

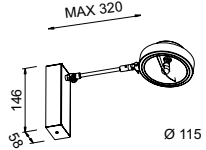
	QR-LP 111 G53 12V	W 1x LED/Halo max 60	Kg 0.51	CODE LT1411	Col. 03 21 22 23 24	  
		<p>Compatibilità trasformatore 230V/12V con lampade LED. I trasformatore 230Vac/12Vac presentati in questo catalogo sono testati con i principali produttori di lampade LED. A causa della velocità dell'adeguamento tecnologico di queste ultime, Lucifero's non può garantire una compatibilità universale delle stesse con i propri trasformatore. Il peso massimo consentito delle lampade LED QR-LP 111 sui nostri proiettori è di 275 g.   230V/12V transformer's compatibility with LED lamps : the 230Vac/12Vac transformers presented on this catalogue have been tested with the leading LED lamps manufacturers. Due to the pace of the technological update of them, Lucifero's cannot guarantee their universal compatibility with its transformers. The maximum allowed weight of 12V QR-LP 111 LED lamps is of 275 gr.   Compatibilidad transformadores 230V/12V con lamparas LED: los transformadores 230Vac/12Vac presentados en este catálogo han sido testados con los principales productores de lámparas LED. Debido a la rápida evolución tecnológica de estas, Lucifero's no puede garantizar una compatibilidad universal de las mismas con nuestros transformadores. El peso máximo admisible de las lámparas LED QR-LP 111 para nuestros proyectores es de 275gr.</p>				

03 - cromo - chrome - cromo

21 - bianco - cromo - white - chrome - blanco - cromo

22 - bianco - cromo satinato - white - brushed chrome - blanco - cromo satinado

23 - grigio - cromo - grey - chrome - gris - cromo

24 - grigio - cromo satinato - grey - brushed chrome - gris - cromo satinado

## EXTENSOR FOCUS 1



QR-CB51 GU5,3 12V W  
1x LED/Halo max 50

Kg CODE Col.  
0.44 LT1456 03 21 22 23 24 26



Compatibilità trasformatore 230V/12V con lampade LED. I trasformatore 230Vac/12Vac presentati in questo catalogo sono testati con i principali produttori di lampade LED. A causa della velocità dell'aggiornamento tecnologico di queste ultime, Lucifero's non può garantire una compatibilità universale delle stesse con i propri trasformatore. | 230V/12V transformer's compatibility with LED lamps : the 230Vac/12Vac transformers presented on this catalogue have been tested with the leading LED lamps manufacturers. Due to the pace of the technological update of them, Lucifero's cannot guarantee their universal compatibility with its transformers. | Compatibilidad transformadores 230V/12V con lamparas LED: los transformadores 230Vac/12Vac presentados en este catálogo han sido testados con los principales productores de lámparas LED. Debido a la rápida evolución tecnológica de estas, Lucifero's no puede garantizar una compatibilidad universal de las mismas con nuestros transformadores.

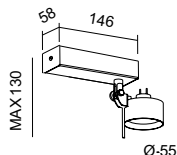

accessori - accessories - accesorios

## EXTENSOR FOCUS 2



QR-CB51 GU5,3 12V W  
2x LED/Halo max 50

Kg CODE Col.  
0.54 LT1457 03 21 22 23 24 26



Compatibilità trasformatore 230V/12V con lampade LED. I trasformatore 230Vac/12Vac presentati in questo catalogo sono testati con i principali produttori di lampade LED. A causa della velocità dell'aggiornamento tecnologico di queste ultime, Lucifero's non può garantire una compatibilità universale delle stesse con i propri trasformatore. | 230V/12V transformer's compatibility with LED lamps : the 230Vac/12Vac transformers presented on this catalogue have been tested with the leading LED lamps manufacturers. Due to the pace of the technological update of them, Lucifero's cannot guarantee their universal compatibility with its transformers. | Compatibilidad transformadores 230V/12V con lamparas LED: los transformadores 230Vac/12Vac presentados en este catálogo han sido testados con los principales productores de lámparas LED. Debido a la rápida evolución tecnológica de estas, Lucifero's no puede garantizar una compatibilidad universal de las mismas con nuestros transformadores.

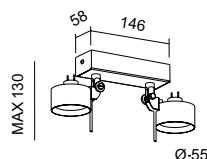

accessori - accessories - accesorios

Accessori - Accessories - Accesorios

## HONEY COMB

HONEY COMB LOUVER - ANTI DESLUMBRAMIENTO "HONEY COMB"



CODE  
LT9884

03 - cromo - chrome - cromo

21 - bianco - cromo - white - chrome - blanco - cromo

22 - bianco - cromo satinato - white - brushed chrome - blanco - cromo satinado

23 - grigio - cromo - grey - chrome - gris - cromo

24 - grigio - cromo satinato - grey - brushed chrome - gris - cromo satinado

26 - nero.cromo satinato - black.satin chrome - negro.saten cromo



pag.824



Profili da binario Eurostandard 230V per illuminazione diretta diffusa. Per sorgenti lineari LED. Alimentazione integrata. Completi di adattatore Eurostandard. Corpo in estruso di alluminio, finitura verniciata o anodizzata. Schermo diffondente in policarbonato opalino bianco e testate di chiusura laterali con sistema Light Proof. Grado di protezione IP40.

Series of track profiles for direct diffused lighting. For linear LED sources with integrated electronic supply. Supplied with Eurostandard adapter. Body in extruded aluminium, painted or anodized finish. Opal white polycarbonate diffuser and Light Proof system side-end caps. Degree of protection IP40.

Serie de perfiles por carril para la iluminación directa difuminada. Para fuentes de luz LED. Alimentación electrónica integrada completado de adaptador Eurostandard. Cuerpo en estruso de aluminio, acabado barnizado o anodizado. Difusor en policarbonato opal blanco y tapas de cierre laterales con sistema Light Proof. Grado de protección IP40.

---

**MINIFILE OPENLIGHTTRACK**



PROJECTORS



TABAKALERA - CENTRO INTERNACIONAL DE CULTURA CONTEMPORÁNEA - SPAIN  
LIGHTING TAO ILLUMINACION



## SEZIONE PROFILO MINIFILE OPENLIGHT TRACK

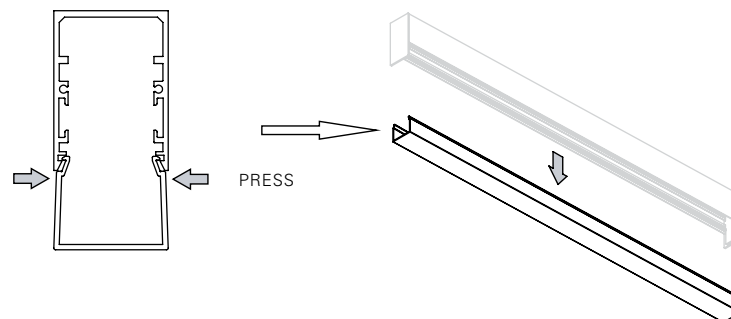
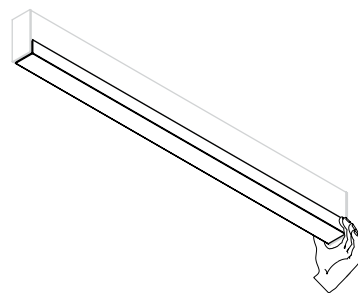
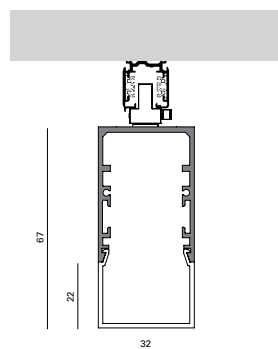
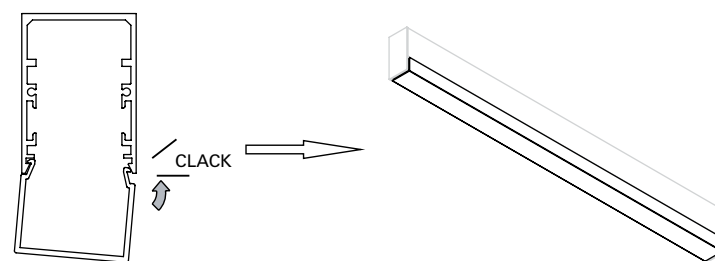
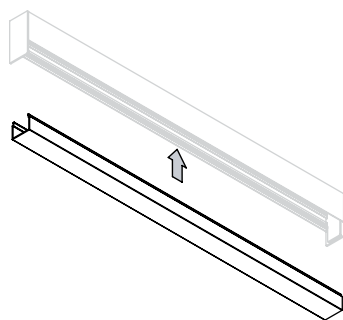

# MINIFILE OPENLIGHT TRACK CON DIFFUSORE

TRACK WITH DIFFUSER- TRACK CON DIFUSOR



	W	K	lm product	lm/Led	CRI	Dali	L,mm	CODE	Col.
LINEAR LED 24W/MT 2200lm/MT CRI>80	12,8	3000	736	1232	>80		580	<b>MO120</b>	<b>01 27</b>
	12,8	3000	736	1232	>80	x	580	<b>MO120D</b>	<b>01 27</b>
	19,2	3000	1104	1848	>80		860	<b>MO121</b>	<b>01 27</b>
	19,2	3000	1104	1848	>80	x	860	<b>MO121D</b>	<b>01 27</b>
	25,6	3000	1472	2464	>80		1140	<b>MO122</b>	<b>01 27</b>
	25,6	3000	1472	2464	>80	x	1140	<b>MO122D</b>	<b>01 27</b>
	32	3000	1840	3080	>80		1420	<b>MO123</b>	<b>01 27</b>
	32	3000	1840	3080	>80	x	1420	<b>MO123D</b>	<b>01 27</b>
	38,4	3000	2208	3696	>80		1700	<b>MO124</b>	<b>01 27</b>
	38,4	3000	2208	3696	>80	x	1700	<b>MO124D</b>	<b>01 27</b>

50000h Ta 25°  
L70B10



Su richiesta disponibile la versione 4000°K | On request available version 4000°K | Versión con 4000K a demanda

Dali : Versione dimmerabile Dali. Adattatore compatibile con binari One Track (A.A.G. Stucchi ) o Global Track pulse (Nordic Aluminium)/ Dimmable Dali version. For connection to the One Track (A.A.G. Stucchi ) or Global Track pulse (Nordic Aluminium)/ Versione dimmable Dali. Se puede usar en el binario One Track (A.A.G. Stucchi ) or Global Track pulse (Nordic Aluminium).

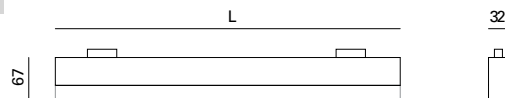

01 - bianco - white - blanco

27 - ossidato alluminio - oxidised aluminium - oxidado aluminio



pag.824

TABAKALERA - CENTRO INTERNACIONAL DE CULTURA CONTEMPORÀNEA - SPAIN  
LIGHTING TAO ILLUMINACION

---

Profilo da binario Eurostandard 230V per illuminazione diretta diffusa, per sorgenti lineari LED o lampade fluorescenti T16 e T16 seamless. Alimentazione elettronica integrata 50/60Hz 230/240V. Corpo in estruso di alluminio 75x78mm. Finitura verniciata o anodizzata. Completi di adattatore a binario, testate di chiusura laterali con sistema Light Proof e schermo diffondente in PC opalino bianco o microprismatico (conforme normativa EN12464-1) o griglia dark-light in alluminio ad alta specularità. Grado di protezione IP20/IP40.

230V Eurostandard track profile for diffused direct lighting, complete with professional linear LED source or battens for T16 linear fluorescent lamps. Complete with 50/60 Hz 230/240 V electronic power supply. Body in 75x78 mm. extruded aluminium. Painted or anodized finish. Complete with track adapter, Light Proof system side end caps, opal white or microprismatic polycarbonate diffusing screen (conform to EN 12464-1 EU directive) or high efficiency dark-light aluminium grid. IP20/IP40 protection degree.

Profiles para raíl Eurostandard 230V para iluminación directa difuminada, con LED lineales o con regletas para fluorescentes T16. Alimentación electrónica integrada 50/60Hz 230V/240V. Cuerpo en estruso de aluminio 75x78mm. Acabado pintado o anodizado. Con adaptador para raíl, tapas de cierre laterales con sistema "Light Proof" y difusor en policarbonato opal blanco o microprismático (conforme normativa EN 12464-1) o con dark-light en aluminio de gran luminosidad. Grado de protección IP20/IP40.

---



**FILE 2 TRACK**



PROJECTORS

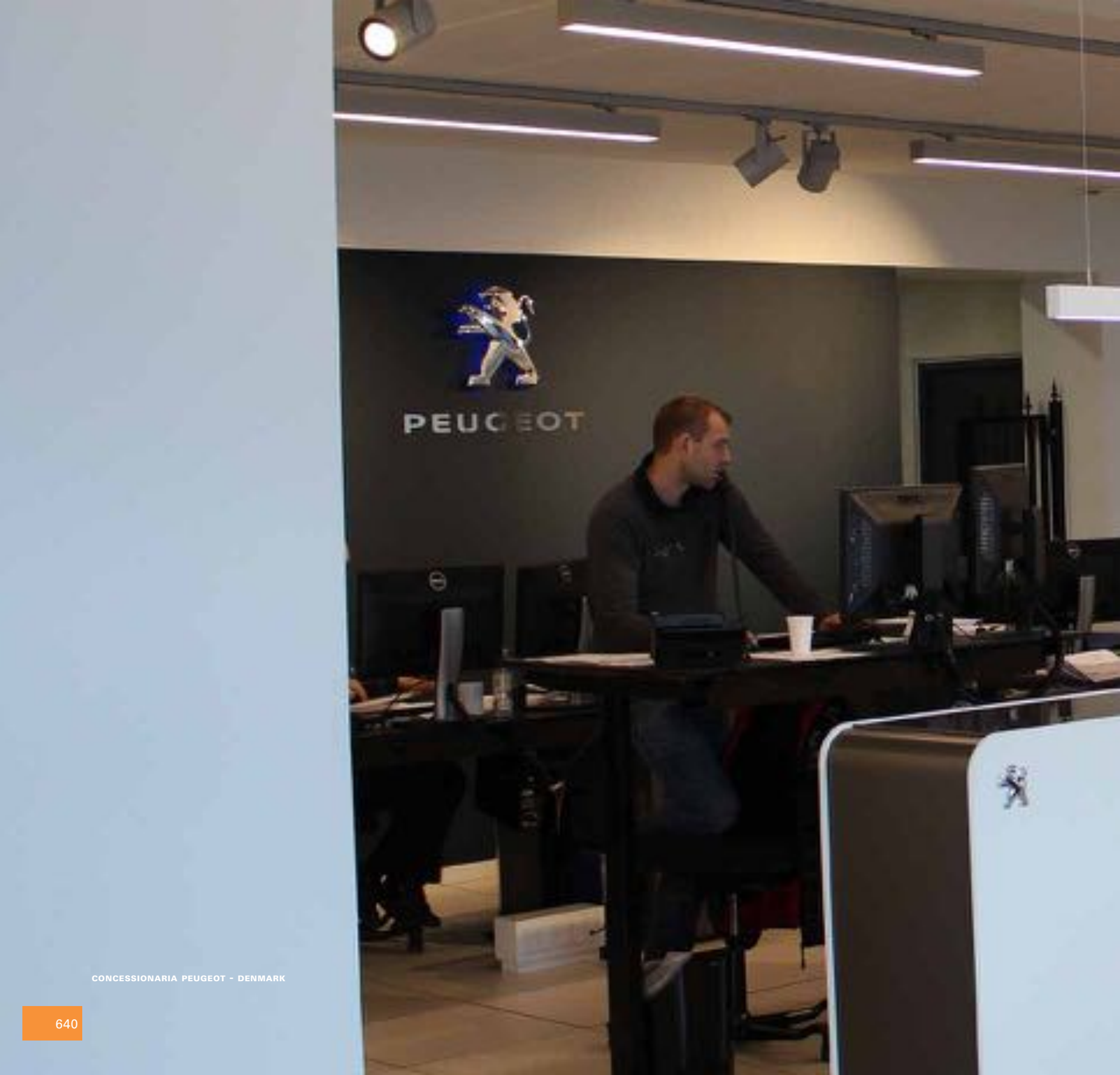

CONCESSIONARIA PEUGEOT - DENMARK



## FILE 2 TRACK CON DIFFUSORE OPALINO

LED WITH OPALINE DIFFUSER- LED A BINARIO CON DIFFUSOR OPALINO



	W	K	lm product	lm/Led	CRI	Dali	Lmm	CODE	Col.	
LINEAR LED 24W/MT 2200LM/MT CRI>80  50000h Ta 25° L70B10	19,2	3000	1104	1848	>80		860	LTCS30B	01 02 27 49	
	19,2	3000	1104	1848	>80	x	860	LTCS30BD	01 02 27 49	
	25,6	3000	1472	2464	>80		1140	LTCS31B	01 02 27 49	
	25,6	3000	1472	2464	>80	x	1140	LTCS31BD	01 02 27 49	
	32	3000	1840	3080	>80		1420	LTC532B	01 02 27 49	
	32	3000	1840	3080	>80	x	1420	LTC532BD	01 02 27 49	
LINEAR LED 41W/MT 4640LM/MT CRI90	34,2	3000	2330	3900	90		860	LTCS30AB	01 02 27 49	
	45,6	3000	3107	5200	90		1140	LTC531AB	01 02 27 49	
	57	3000	3884	6500	90		1420	LTC532AB	01 02 27 49	
T16 G5 230V	21-39						879	LT2530B	01 02 27 49	
	28-54						1179	LT2532B	01 02 27 49	
	35-49-80						1479	LT2534B	01 02 27 49	
	2x21-39						879	LT2542B	01 02 27 49	
	2x28-54						1179	LT2544B	01 02 27 49	
	2x35-49						1479	LTA546B	01 02 27 49	
2x80						1479	LTB546B	01 02 27 49		

Installabile sulla maggior parte dei binari 3 fasi in commercio. Il prodotto in finitura bianco ed ossidato alluminio prevede adattatore bianco. Il prodotto in finitura nero moka ha adattatore nero. | Can be installable on most 3 phases tracks in trade the product in white and oxidised silver mount a white track adapter. The product in black painted brown mount a black track adapter. | Instalar en la mayoría carril 3 fases en el comercio. Sel producto en acabado blanco y oxidao aluminio tiene adaptador blanco. El producto en acabado negro, mocha tiene adaptador negro.

Dali : Versione dimmerabile Dali. Adattatore compatibile con binari One Track (A.A.G. Stucchi ) o Global Track pulse (Nordic Aluminium)/ Dimmable Dali version. For connection to the One Track (A.A.G. Stucchi ) or Global Track pulse (Nordic Aluminium)/ Versione dimmable Dali. Se puede usar en el binario One Track (A.A.G. Stucchi ) or Global Track pulse (Nordic Aluminium)

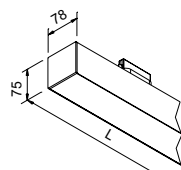

## FILE 2 TRACK CON DIFFUSORE MOCROPRISMATICO\*

LED WITH MICROPRISMATIC DIFFUSER- LED A BINARIO CON DIFFUSOR

	W	K	lm product	lm/Led	CRI	Dali	Lmm	CODE	Col.
 LINEAR LED 24W/MT 2200Lm/MT CRI>80  50000h Ta 25° L70B10 <b>A+</b>	19,2	3000	1296	1848	>80		860	LTC530BX	01 02 27 49
	19,2	3000	1296	1848	>80	x	860	LTC530BXD	01 02 27 49
	25,6	3000	1728	2464	>80		1140	LTC531BX	01 02 27 49
	25,6	3000	1728	2464	>80	x	1140	LTC531BXD	01 02 27 49
	32	3000	2160	3080	>80		1420	LTC532BX	01 02 27 49
	32	3000	2160	3080	>80	x	1420	LTC532BXD	01 02 27 49

PER LA VERSIONE 4000K VEDI CODICI .4 A LISTINO | FOR 4000K VERSION SEE CODE .4 ON PRICELIST | POR LA VERSIÓN 4000K VER CODIGO .4 EN LA LISTA DE PRECIOS.

	W	K	lm product	lm/W	CRI	Lmm	CODE	Col.
LINEAR LED 41W/MT 4640Lm/MT CRI90  <b>A+</b>	34,2	3000	2242	114	90	860	LTC530ABX	01 02 27 49
	45,6	3000	2989	114	90	1140	LTC531ABX	01 02 27 49
	57	3000	3737	114	90	1420	LTC532ABX	01 02 27 49

PER LA VERSIONE 4000K VEDI CODICI .4 A LISTINO | FOR 4000K VERSION SEE CODE .4 ON PRICELIST | POR LA VERSIÓN 4000K VER CODIGO .4 EN LA LISTA DE PRECIOS.

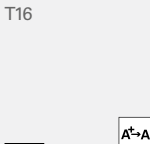
T16	W	Lmm	CODE	Col.
 <b>A+-A</b>	21-39	879	LT2530BX	01 02 27 49
	28-54	1179	LT2532BX	01 02 27 49
	35-49-80	1479	LT2534BX	01 02 27 49
	2x21-39	879	LT2542BX	01 02 27 49
	2x28-54	1179	LT2544BX	01 02 27 49
	2x35-49	1479	LT2546BX	01 02 27 49
	2x80	1479	LTA546BX	01 02 27 49
				LTB546BX

Installabile sulla maggior parte dei binari 3 fasi in commercio. Il prodotto in finitura bianco ed ossidato alluminio prevede adattatore bianco. Il prodotto in finitura nero moka ha adattatore nero. | Can be installable on most 3 phases tracks in trade the product in white and oxidised silver mount a white track adapter. The product in black painted brown mount a black track adapter. | Instalar en la mayoría carril 3 fases en el comercio. Sel producto en acabado blanco y oxidado aluminio tiene adaptador blanco. El producto en acabado negro, mocha tiene adaptador negro.

\*DIFFUSORE MOCROPRISMATICO A LUMINANZA CONTROLLATA (CONFORME NORMATIVA EN 12464-1) - CONTROLLED LUMINANCE MICROPRISMATIC DIFFUSER (CONFORMS TO STANDARD EN 12464-1) - DIFUSOR MOCROPRISMATICO A LUMINANZA CONTROLADA (SEGÚN EN 12464-1)

Dali: Versione dimmerabile Dali. Adattatore compatibile con binari One Track (A.A.G. Stucchi ) o Global Track pulse (Nordic Aluminium)/ Dimmable Dali version. For connection to the One Track (A.A.G. Stucchi ) or Global Track pulse (Nordic Aluminium)/ Versione dimmabile Dali. Se puede usar en el binario One Track (A.A.G. Stucchi ) or Global Track pulse (Nordic Aluminium)

## FILE 2 TRACK CON RIFLETTORE DARKLIGHT\*

FLUO WITH DARKLIGHT REFLECTOR- FLUO CON REFLECTORE DARKLIGHT

T16	W	Lmm	CODE	Col.
 <b>A+-A</b>	21-39	879	LT2530BK	01 02 27 49
	28-54	1179	LT2532BK	01 02 27 49
	35-49-80	1479	LT2534BK	01 02 27 49
	2x21-39	879	LT2542BK	01 02 27 49
	2x28-54	1179	LT2544BK	01 02 27 49
	2x35-49	1479	LTA546BK	01 02 27 49
	2x80	1479	LTA546BK	01 02 27 49
				LTB546BK

Installabile sulla maggior parte dei binari 3 fasi in commercio. Il prodotto in finitura bianco ed ossidato alluminio prevede adattatore bianco. Il prodotto in finitura nero moka ha adattatore nero. | Can be installable on most 3 phases tracks in trade the product in white and oxidised silver mount a white track adapter. The product in black painted brown mount a black track adapter. | Instalar en la mayoría carril 3 fases en el comercio. Sel producto en acabado blanco y oxidado aluminio tiene adaptador blanco. El producto en acabado negro, mocha tiene adaptador negro.

\* RIFLETTORE A LUMINANZA CONTROLLATA (CONFORME NORMATIVA EN 12464-1) - CONTROLLED LUMINANCE REFLECTOR (CONFORMS TO STANDARD EN 12464-1) - REFLECTORE A LUMINANZA CONTROLADA (SEGÚN EN 12464-1)

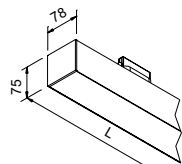

01 - bianco - white - bianco 02 - nero - black - negro 27 - ossidato alluminio - oxidised aluminium - oxidado aluminio 49 - moka - moka - moka

Binario elettrificato misto trifase (tre fasi e un neutro max 16A) con due conduttori aggiuntivi per la gestione di un qualsiasi segnale digitale o analogico (1-10V, DALI, dmx, lon, eib, ecc). La struttura è costituita da un estruso in alluminio verniciato a polveri epossidiche che incorpora quattro conduttori in rame (tre fasi e un neutro max 16A) e due conduttori in rame per il segnale di controllo, isolati mediante canalina in PVC. Conduttore di terra 4mm<sup>2</sup> incorporato nell'alluminio. Possibilità di gestione separata di tre circuiti On/Off oppure di gestione tramite segnale digitale (DALI). Il sistema è certificato secondo la norma EN 60570 e la sua installazione deve essere eseguita da personale qualificato e secondo la normativa d'installazione elettrica vigente. Sono previsti quattro tipi di fissaggio: direttamente a plafone o a parete (in verticale), utilizzando le asole già previste nel binario, a plafone o a parete (in verticale) tramite la clip metallica (da ordinare a parte), appeso tramite i kit di sospensione (da ordinare a parte) o a controsoffitto/a incasso senza superare i carichi massimi specificati. Da utilizzare con proiettori dotati di adattatore Eurostandard (per funzionamento standard) o DALI-Stucchi (per funzionamento DALI).

3 phase mixed-system electrified track, with two additional conductors to manage a general digital or analogic signal (1-10V, DALI, dmx, lon, eib, etc.). Body made of powder coated extruded aluminum, housing four copper conductors (three phases and one neutral 16A) and two copper conductors for the data signal, insulated in PVC. 4mm<sup>2</sup>-section earth conductor incorporated in the extrusion. Arranged for ON/OFF separate three-circuit switch or management through digital signal (DALI). EN 60570 certified. Its installation must be accomplished by highly qualified personnel. Four possible installation systems: directly on ceiling/wall by using the needlepoints provided on the track, on ceiling/wall by using the metal clips (order separately), hanging by using the suspension kits (order separately) or recessed, without exceeding the maximum loads. To be used with projectors provided with Eurostandard adapter (for standard use) or with DALI-Stucchi adapter (for DALI use).

Raíl electrificado mixto trifase (tres fases y un neutro max. 16 A) con dos conductores más para la gestión de cualquier señal digital o analógica (1-10V, DALI, dmx, lon, eib, ecc.). La estructura es de estruso aluminio barnizado con polvos epoxy que incorpora cuatro conductores de cobre (tres fases y un neutro max 16 A) y dos conductores de cobre para la señal de control, aislados mediante una canalita de PVC. Conductor de tierra de 4mm incorporado en el aluminio. Posibilidad de la gestión separada de tres circuitos On/Off o de la gestión a través de señal digital (DALI). El sistema está certificado según las norma EN 60570 y su instalación debe ser realizada por personal cualificado y según las normas de instalación vigentes. Están previstos cuatro tipos de instalación: directamente a plafón o a pared (en vertical), utilizando los agujeros ya existentes en el raíl, a plafón o a pared (en vertical) mediante enganche metálico (a pedir por separado), suspendido mediante kit de suspensión (a pedir por separado), o en falso techo/empotrado sin que supere el pedo máximo especificado. A utilizar con proyectores dotados de adaptador Eurostandard (para el funcionamiento estándar) o con adaptadores DALI-Stucchi (para funcionamiento DALI).



## TRACKS

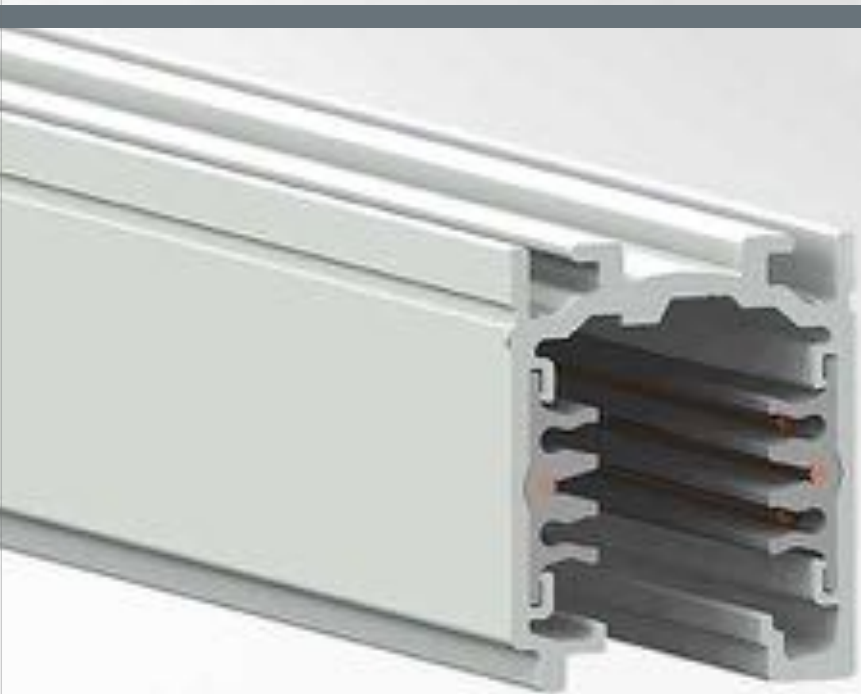

SOFFITTO - CEILING - TECHO

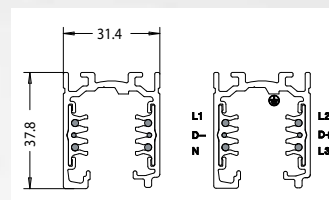

INCASSO RASATO - TRIMLESS RECESSED - TOTAL EMPOTRADO

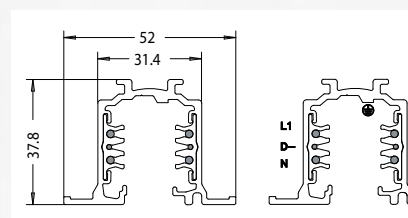





COS STORE FIRENZE  
PROJECT STUDIO SGARGI  
PHOTO A. CIAMPI



## MODULO BINARIO EUROSTANDARD 230V ON/OFF - DALI - 1-10V

230V TRACK MODULE - MODULO CARRIL

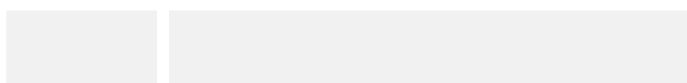

Lmm	Kg	CODE	Col.
1000	0.92	LT9001.1	01 02
2000	1.83	LT9002.1	01 02
3000	2.75	LY9003.1	01 02

Da completare con gli accessori | To complete with accessories | Para completar con accesorios

## MODULO BINARIO DA INCASSO EUROSTANDARD 230V

230V TRACK MODULE - MODULO CARRIL

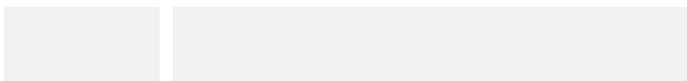

Dim.	Lmm	CODE	Col.
52x378	1000	LT9011.1	01 02
52x378	2000	LT9012.1	01 02
52x378	3000	LT9013.1	01 02

Da completare con gli accessori | To complete with accessories | Para completar con accesorios

## ALIMENTAZIONE DI TESTA DX

RIGHT HEAD FEED FOR TRACK SYSTEM- ALIMENTACIÓN DE CABECERA DERECHA TRACK SYSTEM

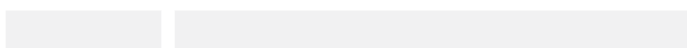
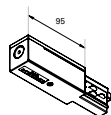

CODE	Col.
LT9020.1	01 02

Possibilità di gestione separata di tre circuiti On/Off oppure di gestione tramite segnale digitale (DALI)/ Arranged for ON/OFF separate three-circuit switch or management through digital signal (DALI)/ Posibilidad de la gestión separada de tres circuitos On/Off o de la gestión a través de señal digital (DALI)

## ALIMENTAZIONE DI TESTA SX

LEFT HEAD FEED FOR TRACK SYSTEM- ALIMENTACIÓN DE CABECERA IZQUIERDA TRACK SYSTEM

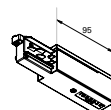

CODE	Col.
LT9021.1	01 02

Possibilità di gestione separata di tre circuiti On/Off oppure di gestione tramite segnale digitale (DALI)/ Arranged for ON/OFF separate three-circuit switch or management through digital signal (DALI)/ Posibilidad de la gestión separada de tres circuitos On/Off o de la gestión a través de señal digital (DALI)

## GIUNTO LINEARE

CONNECTOR FOR TRACK SYSTEM- UNIONES TRACK SYSTEM

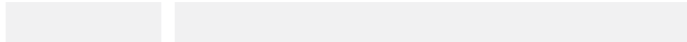

CODE	Col.
LT9023.1	01 02

01 - bianco - white - blanco 02 - nero - black - negro

## TAPPO DI CHIUSURA

BLIND END TRACK SYSTEM - TAPA DE CIERRE TRACK SYSTEM



CODE	Col.
LT9033.1	01 02

## TRACKS TAPPO DI CHIUSURA INCASSO

TAPPO DI CHIUSURA INCASSO- RECESSED END CAP- TAPON DE CIERRE



CODE	Col.
LT9033IN.1	01 02

## TRACKS ALIMENTATORE CENTRALE

ALIMENTATORE CENTRALE- MID FEED- ALIMENTADOR CENTRAL

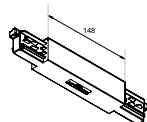

Possibilità di gestione separata di tre circuiti On/Off oppure di gestione tramite segnale digitale (DALI)/ Arranged for ON/OFF separate three-circuit switch or management through digital signal (DALI)/ Posibilidad de la gestión separada de tres circuitos On/Off o de la gestión a través de señal digital (DALI)

CODE	Col.
LT9022.1	01 02

## TRACKS COPERTURA PER ALIMENTATORE CENTRALE

COPERTURA PER ALIMENTATORE CENTRALE- COVER MID FEED- PARA ALIMENTADOR CENTRAL

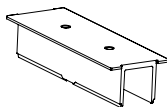

CODE	Col.
LT9051.1	01 02

## TRACKS GIUNTO "L"

GIUNTO "L"- "L" JOINT - JUNTO "L"

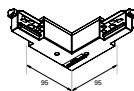

Dim.	Lmm
esterno	95x95
interno	95x95

CODE	Col.
LT9026.1	01 02
LT9027.1	01 02

01 - bianco - white - blanco 02 - nero - black - negro

## TRACKS COPERTURA PER GIUNTO A "L"

COPERTURA PER GIUNTO A "L" - COVER "L" JOINT- PARA JUNTO "L"

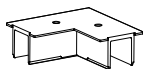

CODE	Col.
LT9052.1	01 02

## TRACKS GIUNTO "T"

GIUNTO "T" - "T" JOINT- JUNTO "T"

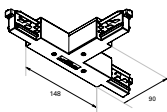

Dim.	Lmm	CODE	Col.
esterno dx	148x90	LT9028.1	01 02
esterno sx	148x90	LT9029.1	01 02
interno dx	148x90	LT9030.1	01 02
interno sx	148x90	LT9031.1	01 02

## TRACKS COPERTURA PER GIUNTO A "T"

COPERTURA PER GIUNTO A "T" - COVER "T" JOINT- PARA JUNTO "T"

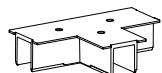

CODE	Col.
LT9053.1	01 02

## TRACKS GIUNTO "X"

GIUNTO "X" - "X" JOINT - JUNTO "X"

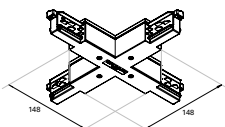

Dim.	CODE	Col.
148x148	LT9032.1	01 02

## TRACKS COPERTURA PER GIUNTO A "X"

COPERTURA PER GIUNTO A "X" - COVER "X" JOINT- PARA JUNTO "X"

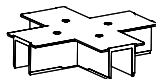

CODE	Col.
LT9054.1	01 02

## TRACKS CURVA REGOLABILE 0°-360°

CURVA REGOLABILE 0°-360° - FLEXIBLE CORNER CONNECTOR 0°-360° - CURVA REGULABLE 0°-360°

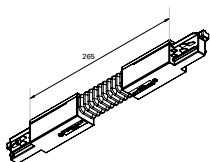

CODE	Col.
LT9024.1	01 02

01 - bianco - white - blanco 02 - nero - black - negro

## TRACKS COPRIFILO IP40

COPRIFILO IP40 - CABLE COVER IP40 - CUBREHILO IP40

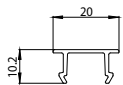

CODE	Col.
LT9040.1	01

## TRACKS STAFFA DI FISSAGGIO A SOFFITTO

STAFFA DI FISSAGGIO A SOFFITTO - CEILING CLIP - ABRAZADERA DE FIJACION A TECHO

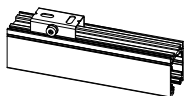

CODE
LT9038.1

## TRACKS UTENSILE PER PIEGATURA

UTENSILE PER PIEGATURA - BENDING TOOL - UTENSILO PARA PIEGADO CONDUCTORES

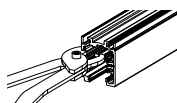

CODE
LT9043.1

## TRACKS GIUNTO PER SOSPENSIONE

GIUNTO PER SOSPENSIONE - CONNECTOR FOR SUSPENDED TRACK - JUNTA DE SUSPENSION

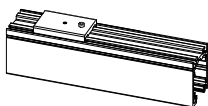

CODE	Col.
LT9034.1	01 02

## TRACKS SOSPENSIONE CON CAVO DI ACCIAIO

SOSPENSIONE CON CAVO DI ACCIAIO - STEEL SUSPENSION CABLE - JUNTA DE SUSPENSION CON ALIMENTADOR

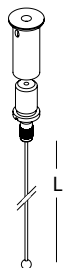

CODE
LT9036.1

01 - bianco - white - blanco

27 - ossidato alluminio - oxidised aluminium - oxidado aluminio



**SCHEMA D'UTILIZZO - HOWTO FIT - ESQUEMA DI'UTILIZZO**

SCelta DELLE CONNESSIONI - CHOICE OF CONNECTIONS - ELECCION DE CONEXIONES

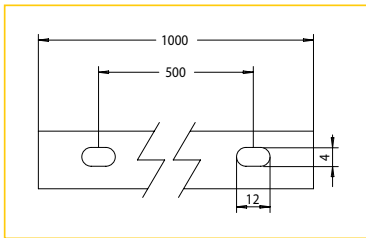
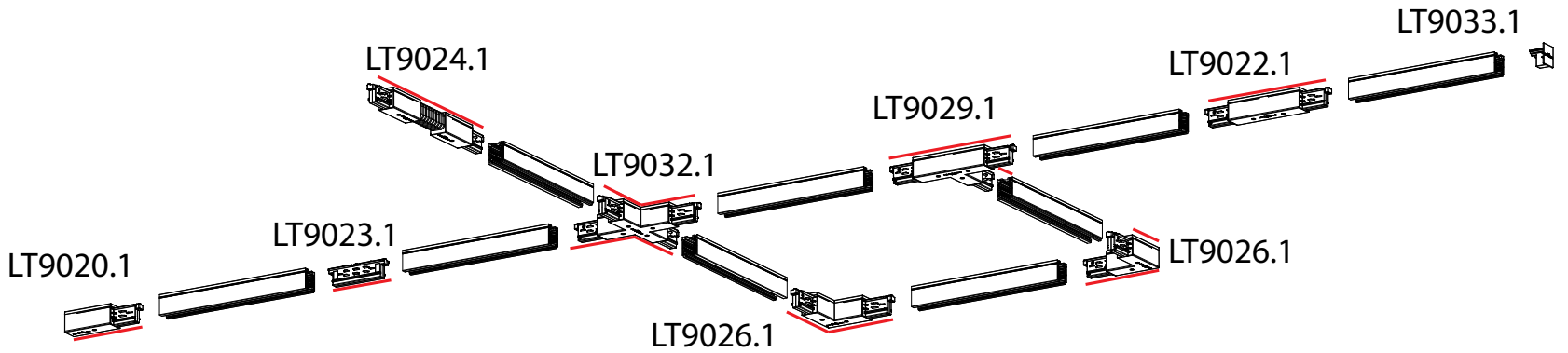

Fig. 1 Posizione asole  
Pic. 1 Neede points position

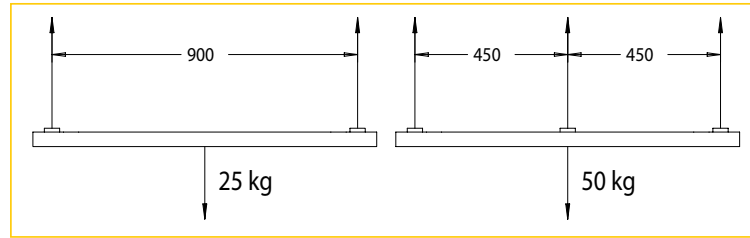

Fig. 2 Schema di carico  
Pic. 2 Load scheme

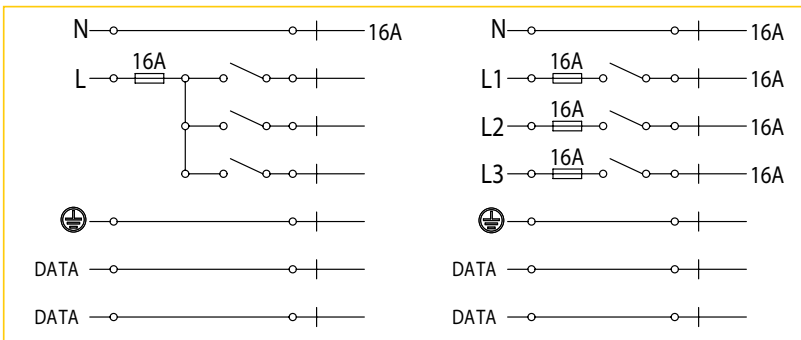

Fig. 3 Schema elettrico  
Pic. 3 Electrical scheme





## WALL CEILING & FLOOR LIGHTING RANGE

iCEMENTI p.656



iPIPEDI p.670



FILE 2 COMPLEMENTI p.692



MANINE p.696



APP-LIQUES p.704



RIGO p.708



SCENA p.716



STRUTTURA p.724





WALL CEILING FLOOR

## ICEMENTI

Famiglia di apparecchi da pavimento, soffitto, sospensione, soffitto e parete, per illuminazione diffusa o di orientamento e guida. Completi di sorgenti LED *chip on board* e alimentazione elettronica integrata 50/60Hz. Versioni da terra fornite di gruppo ottico in alluminio con emissione mono o bilaterale e piastra di montaggio in acciaio per il fissaggio a terra con blocco antifurto. Corpo in "CementoPiuma" VFRC (vinilic fiber reinforced concrete) cemento fibrato alleggerito. Schermo diffondente in PMMA opalino bianco (Zero51). Grado di protezione IP40 o IP65 a seconda dei modelli.

Family floor, suspended, ceiling and wall-mounted fittings for diffused or directional and guidance lighting. Complete with chip on board LED source and 50/60Hz built-in electronic driver. Floor versions supplied complete of aluminium optical unit with mono or bilateral light emission and steel mounting plate for fixing to the ground with anti-theft system. Body in VFRC (vinilic fiber reinforced concrete) "CementoPiuma" Diffusing screen in white opaline PMMA (Zero51). Degree of protection IP40 or IP65, according to the models.

Aparatos de suelo, suspensión, techo y pared iluminación difuminada o de señalización y guía. Completos de LED *chip on board* y alimentación electrónica integrada 50/60Hz. Modelos de suelo completos de grupo óptico en aluminio con emisión mono o bilateral y soporte de montaje en acero para la fijación en el suelo con bloque antirobo. Cuerpo en "CementoPiuma" VFRC (vinilic fiber reinforced concrete), cemento fibrato ligero. Pantalla en PMMA opal blanca (Zero51). Grado de protección IP40 o IP65, en función de los modelos.



iCementi

WALL CEILING FLOOR





# PEAR

SUSPENSION - SUSPENSION



LED E14 230V

A+

W

1xmax15

Dim.  
ø156

H  
325

Kg  
2,5

CODE  
IC1501

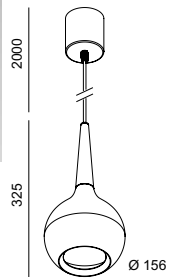









PALESTRA CAGY CUN - TUNISIA

## ZERO51 SOFFITTO





ZERO51 CEILING-MOUNTED- ZERO51 TECNO

LED	W	K	lm product	lm/Led	CRI	Dali-T&D-1-10V	Dim.	H	Kg	CODE	A+
	48	3000	3358	4720	80	x	ø700	150	17	<b>IC0701.830D</b>	    
	96	3000	6716	9440	80		ø1000	150	26	<b>IC0702.830</b>	
	96	3000	6716	9440	80	x	ø1000	150	26	<b>IC0702.830D</b>	
	168	3000	11752	16520	80		ø1300	150	40	<b>IC0703.830</b>	
	168	3000	11752	16520	80	x	ø1300	150	40	<b>IC0703.830D</b>	
	48	4000	3842	5400	80	x	ø700	150	17	<b>IC0701.840D</b>	
	96	4000	7683	10800	80		ø1000	150	26	<b>IC0702.840</b>	
	96	4000	7683	10800	80	x	ø1000	150	26	<b>IC0702.840D</b>	
	168	4000	13445	18900	80		ø1300	150	40	<b>IC0703.840</b>	
	168	4000	13445	18900	80	x	ø1300	150	40	<b>IC0703.840D</b>	



## ZERO51 SOSPENSIONE

ZERO51 HANGING- ZERO51 SOSPENSION

LED	W	K	lm product	lm/Led	CRI	Dali-T&D-1-10V	Dim.	H	Kg	CODE	A+
	48	3000	3358	4720	80	x	ø700	150	18	<b>IC0601.830D</b>	    
	96	3000	6716	9440	80		ø1000	150	27	<b>IC0602.830</b>	
	96	3000	6716	9440	80	x	ø1000	150	27	<b>IC0602.830D</b>	
	168	3000	11752	16520	80		ø1300	150	41	<b>IC0603.830</b>	
	168	3000	11752	16520	80	x	ø1300	150	41	<b>IC0603.830D</b>	
	48	4000	3842	5400	80	x	ø700	150	18	<b>IC0601.840D</b>	
	96	4000	7683	10800	80		ø1000	150	27	<b>IC0602.840</b>	
	96	4000	7683	10800	80	x	ø1000	150	27	<b>IC0602.840D</b>	
	168	4000	13445	18900	80		ø1300	150	41	<b>IC0603.840</b>	
	168	4000	13445	18900	80	x	ø1300	150	41	<b>IC0603.840D</b>	

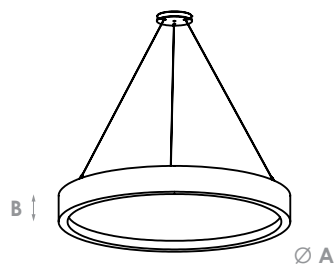

WALL CEILING FLOOR



## PANCA



LINEAR LED IP65  
14,4W/MT  
60LED/MT 24V

A+

W	K	lm product	lm/Led	CRI
172	3000	650	1080	80
172	4000	693	1152	80

Dim.	H	Kg
1500x450	450	39
1500x450	450	39

CODE  
IC0501.830  
IC0501.840



Dim.	H	Kg
1500x450	450	37

CODE  
IC0502\*\*



\*\* versione non elettrificata / non-electrified version / versión no electrificada

Seduta conforme alla normativa UNI 11306 del 02.2009/ Seat conforms to standard UNI 11306 of 02.2009/Asiento conforme a la normativa UNI 11306 del 02.2009

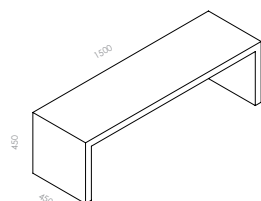

## PANCHETTO



LED

A+

W	K	lm product	lm/Led	CRI
3	3000	150	270	80
3	4000	161	290	80

Dim.	H	Kg
450x450	450	22
450x450	450	22

CODE  
IC0401.830  
IC0401.840



Dim.	H	Kg
450x450	450	20

CODE  
IC0402\*\*



\*\* versione non elettrificata / non-electrified version / versión no electrificada

Seduta conforme alla normativa UNI 11306 del 02.2009/ Seat conforms to standard UNI 11306 of 02.2009/Asiento conforme a la normativa UNI 11306 del 02.2009

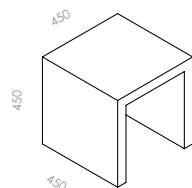





## MONOLYTE



LED	W	K	lm product	lm/Led	CRI	Dim.	H	Kg	CODE
A+	3	3000	85	270	80	150x250	600	22	IC0201.830
	3	4000	91	290	80	150x250	600	22	IC0201.840

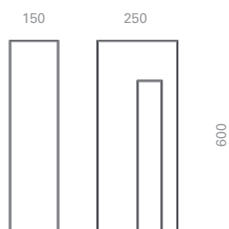

## CENTO3CENTO



LED	W	K	lm product	lm/Led	CRI	Dim.	H	Kg	CODE
A+	3	3000	70	270	80	100x300	250	78	IC0101.830
	3	4000	75	290	80	100x300	250	78	IC0101.840

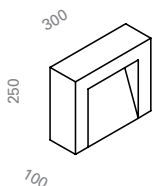

## PASTORALE

TERRA - FLOOR - PIE



LED	W	K	lm product	lm/Led	CRI	Dim.	H	Kg	CODE
A+	3	3000	150	270	80	200x200	350	9	IC0301.830
	3	4000	161	290	80	200x200	350	9	IC0301.840
	6	3000	300	540	80	200x200	800	13	IC0302.830
	6	4000	322	580	80	200x200	800	13	IC0302.840

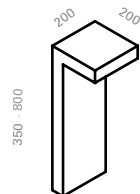
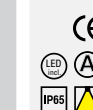

pag.824



CLINICA SAN VICENTE - SPAIN  
PROJECT TAO ILUMINACION  
PHOTO BIDERBOST



## 2B01

SUSPENSION - SUSPENSION



QPAR16 GU10 230V

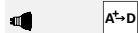

W  
1x max 50

Dim.  
ø80

H  
450

Kg  
2,9

CODE  
IC1401

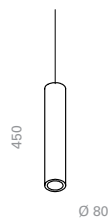

## 2B02 SOFFITTO

CEILING- TECHO



QPAR30 E27 230V



W  
1x max 100

Dim.  
ø120

H  
280

Kg  
3,1

CODE  
IC1201

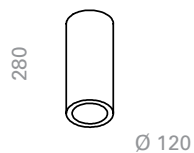

## 2B02 SOSPENSIONE

SUSPENSION- SUSPENSION



QPAR30 E27 230V



W  
1x max 100

Dim.  
ø120

H  
280

Kg  
3,1

CODE  
IC1301

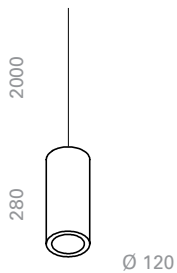



## BRIQUEV

WALL - PARED



	W	K	lm product	lm/Led	CRI	Dim.	H	Kg	CODE	
LED	6	3000	300	540	80	120x100	200	2,2	<b>IC1101.830</b>	
	6	4000	322	580	80	120x100	200	2,2	<b>IC1101.840</b>	



	W	K	lm product	lm/Led	CRI	Dim.	H	Kg	CODE	
LED	6+6	3000	600	1080	80	120x100	200	2,5	<b>IC1102.830</b>	
	6+6	4000	644	1160	80	120x100	200	2,5	<b>IC1102.840</b>	

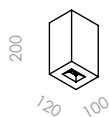

## BRIQUEO

WALL - PARED



	W	K	lm product	lm/Led	CRI	Dim.	H	Kg	CODE	
LED	6	3000	300	540	80	120x250	80	2,6	<b>IC1001.830</b>	
	6	4000	322	580	80	120x250	80	2,6	<b>IC1001.840</b>	



	W	K	lm product	lm/Led	CRI	Dim.	H	Kg	CODE	
LED	6+6	3000	600	1080	80	120x250	80	2,8	<b>IC1002.830</b>	
	6+6	4000	644	1160	80	120x250	80	2,8	<b>IC1002.840</b>	

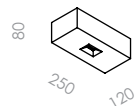

WALL CEILING FLOOR

---

Apparecchi a plafone, sospensione e parete per illuminazione diretta fissa od orientabile, completi di sorgenti LED professionali o per lampade led/alogene QR-CB51 GU5,3 12V/230 e QPAR16 GU10 230V. Completi di gruppo di alimentazione. Corpo cilindrico in estruso di alluminio finitura verniciata. Completi di staffa per fissaggio a soffitto, cavi di sospensione in acciaio con sistema di regolazione micrometrica e cavo di alimentazione L.2000 mm. o basetta di fissaggio a parete a seconda dei modelli. Grado di protezione IP20/IP54.

Ceiling-mounted, wall-mounted or hanging fixtures for fix or adjustable direct lighting. Complete with professional LED source, or for 12V/230V GU5,3 QR-CB51 and 230V GU10 QPAR16 led/halogen lamps. Complete with control-gear box. Cylindrical body in painted extruded aluminium. Complete with ceiling mounting bracket, L.2000 mm feed cable and suspension steel cables with micrometric regulation system or wall fixing bracket, according to the model. IP20/IP54 degree of protection.

Aparato a plafón, pared y techo para iluminación directa fija o orientable, con LED profesionales, o para lamparas led/halogenas QR-CB51 GU5,3 y QPAR16 GU10. Con grupo de alimentación 230V/240V. Cuerpo cilíndrico en estruso de aluminio barnizado. Con soporte de fijación en el techo, cable de suspensión en acero con sistema de regulación micrométrica y cable de alimentación de 2000 mm. o base de fijación a la pared. Grado de protección IP20/IP54.

---

I-PIPEDI



WALL CEILING FLOOR



**A&W** BOUTIQUE CITTÀ DI CASTELLO - ITALY  
PROJECT NOPPSTUDIO ARCH. R.CAPITINI  
PHOTO ER STUDIO





## I-PIPEDI R30 SOFFITTO

CEILING - TECHO

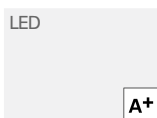

W	mA	K	lm product	lm/Led	CRI	∠	Dim.	H	CODE	Col.
1,5	500	2700	252	145	80	16°	ø30	700	PP001.827S	01 02 12 60 99
1,5	500	2700	136	145	80	30°	ø30	700	PP001.827F	01 02 12 60 99
1,5	500	3000	252	145	80	16°	ø30	700	PP001.830S	01 02 12 60 99
1,5	500	3000	136	145	80	30°	ø30	700	PP001.830F	01 02 12 60 99



## I-PIPEDI R55 SOFFITTO

CEILING - TECHO

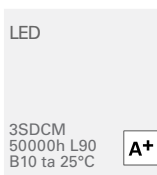

W	K	lm product	lm/Led	CRI	DimTF	∠	Dim.	H	Kg	CODE	Col.
6,8	2700	321	480	>90		24°	ø55	300	1,07	PP011.927F	01 02 12 60 99
6,8	2700	321	480	>90	x	24°	ø55	300	1,07	PP011.927FDF	01 02 12 60 99
6,8	2700	437	480	>90		36°	ø55	300	1,07	PP011.927W	01 02 12 60 99
6,8	2700	437	480	>90	x	36°	ø55	300	1,07	PP011.927WDF	01 02 12 60 99
6,8	3000	330	494	>90		24°	ø55	300	1,07	PP011.930F	01 02 12 60 99
6,8	3000	330	494	>90	x	24°	ø55	300	1,07	PP011.930FDF	01 02 12 60 99
6,8	3000	450	494	>90		36°	ø55	300	1,07	PP011.930W	01 02 12 60 99
6,8	3000	450	494	>90	x	36°	ø55	300	1,07	PP011.930WDF	01 02 12 60 99

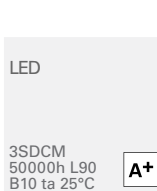

W	K	lm product	lm/Led	CRI	DimTF	∠	Dim.	H	Kg	CODE	Col.
11	2700	931	1100	>90		29°	ø55	300	1,07	PP012.927S	01 02 12 60 99
11	2700	931	1100	>90	x	29°	ø55	300	1,07	PP012.927SDF	01 02 12 60 99
11	2700	703	1100	>90		42°	ø55	300	1,07	PP012.927F	01 02 12 60 99
11	2700	703	1100	>90	x	42°	ø55	300	1,07	PP012.927FDF	01 02 12 60 99
11	3000	1003	1185	>90		29°	ø55	300	1,07	PP012.930S	01 02 12 60 99
11	3000	1003	1185	>90	x	29°	ø55	300	1,07	PP012.930SDF	01 02 12 60 99
11	3000	757	1185	>90		42°	ø55	300	1,07	PP012.930F	01 02 12 60 99
11	3000	757	1185	>90	x	42°	ø55	300	1,07	PP012.930FDF	01 02 12 60 99



W	Dim.	H	Kg	CODE	Col.
1 x max 50	ø55	300	1,04	PP014	01 02 12 60 99



W	Dim.	H	Kg	CODE	Col.
1 x max 50	ø55	300	1,04	PP013	01 02 12 60 99



DimTF: Versione dimmerabile Taglio di fase / Trailing/leading edge dimmable version / Versione dimmable corte de fase.

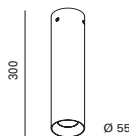

01 - bianco - white - blanco    02 - nero - black - negro    12 - grigio - grey - gris    60 - verniciato cor-ten - painted cor-ten - cor ten barnizado    99 - Grafite - Graphite - Grafito

# I-PIPEDI R90 SOFFITTO

CEILING - TECHO



LED	W	K	lm product	lm/Led	CRI	Dali	DimTF	∠	Dim.	H	CODE	Col.
	17	2700	1438	1790	95		x	15°	ø90	300	PP021.927S	01 02 12 60 99
	17	2700	1438	1790	95	x		15°	ø90	300	PP021.927SD	01 02 12 60 99
	17	2700	1530	1790	95		x	24°	ø90	300	PP021.927F	01 02 12 60 99
	17	2700	1530	1790	95	x		24°	ø90	300	PP021.927FD	01 02 12 60 99
	17	2700	1609	1790	95		x	38°	ø90	300	PP021.927W	01 02 12 60 99
	17	2700	1609	1790	95	x		38°	ø90	300	PP021.927WD	01 02 12 60 99
	17	3000	1546	1925	95		x	15°	ø90	300	PP021.930S	01 02 12 60 99
	17	3000	1546	1925	95	x		15°	ø90	300	PP021.930SD	01 02 12 60 99
	17	3000	1645	1925	95		x	24°	ø90	300	PP021.930F	01 02 12 60 99
	17	3000	1645	1925	95	x		24°	ø90	300	PP021.930FD	01 02 12 60 99
	17	3000	1730	1925	95		x	38°	ø90	300	PP021.930W	01 02 12 60 99
	17	3000	1730	1925	95	x		38°	ø90	300	PP021.930WD	01 02 12 60 99
	24,3	2700	1904	2370	95		x	15°	ø90	300	PP022.927S	01 02 12 60 99
	24,3	2700	1904	2370	95	x		15°	ø90	300	PP022.927SD	01 02 12 60 99
	24,3	2700	2011	2370	95		x	24°	ø90	300	PP022.927F	01 02 12 60 99
	24,3	2700	2011	2370	95	x		24°	ø90	300	PP022.927FD	01 02 12 60 99
	24,3	2700	2095	2370	95		x	38°	ø90	300	PP022.927W	01 02 12 60 99
	24,3	2700	2095	2370	95	x		38°	ø90	300	PP022.927WD	01 02 12 60 99
	24,3	3000	2045	2545	95		x	15°	ø90	300	PP022.930S	01 02 12 60 99
	24,3	3000	2045	2545	95	x		15°	ø90	300	PP022.930SD	01 02 12 60 99
	24,3	3000	2160	2545	95		x	24°	ø90	300	PP022.930F	01 02 12 60 99
	24,3	3000	2160	2545	95	x		24°	ø90	300	PP022.930FD	01 02 12 60 99
	24,3	3000	2250	2545	95		x	38°	ø90	300	PP022.930W	01 02 12 60 99
	24,3	3000	2250	2545	95	x		38°	ø90	300	PP022.930WD	01 02 12 60 99

3SDCM  
50000h L90  
B10 ta 25°C



QPAR16 GU10 230V	W	Dim.	H	CODE	Col.
	50	ø90	300	PP023	01 02 12 60 99



Dali: Versione dimmerabile Dali / Dimmable Dali version / Versione dimmable Dali.  
DimTF: Versione dimmerabile Taglio di fase / Trailing/leading edge dimmable version / Versione dimmable corte de fase.

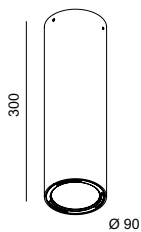

accessori - accessories  
accesorios pag. 690

- 01 - bianco - white - blanco
- 02 - nero - black - negro
- 12 - grigio - grey - gris
- 60 - verniciato cor-ten - painted cor-ten - cor ten barnizado
- 99 - Grafite - Graphite - Grafito



pag.824

# I-PIPEDI R120 SOFFITTO

CEILING - TECHO



LED

3SDCM  
50000h  
L90 B10 ta  
25°C

A+

W	K	lm product	lm/Led	CRI	Dali	DimTF	∠	Dim.	H	CODE	Col.
17	2700	1438	1790	95		x	15°	ø120	380	PP031.927S	01 02 12 60 99
17	2700	1438	1790	95	x		15°	ø120	380	PP031.927SD	01 02 12 60 99
17	2700	1530	1790	95		x	24°	ø120	380	PP031.927F	01 02 12 60 99
17	2700	1530	1790	95	x		24°	ø120	380	PP031.927FD	01 02 12 60 99
17	2700	1609	1790	95		x	38°	ø120	380	PP031.927W	01 02 12 60 99
17	2700	1609	1790	95	x		38°	ø120	380	PP031.927WD	01 02 12 60 99
17	3000	1546	1925	95		x	15°	ø120	380	PP031.930S	01 02 12 60 99
17	3000	1546	1925	95	x		15°	ø120	380	PP031.930SD	01 02 12 60 99
17	3000	1645	1925	95		x	24°	ø120	380	PP031.930F	01 02 12 60 99
17	3000	1645	1925	95	x		24°	ø120	380	PP031.930FD	01 02 12 60 99
17	3000	1730	1925	95		x	38°	ø120	380	PP031.930W	01 02 12 60 99
17	3000	1730	1925	95	x		38°	ø120	380	PP031.930WD	01 02 12 60 99
24,3	2700	1904	2370	95		x	15°	ø120	380	PP032.927S	01 02 12 60 99
24,3	2700	1904	2370	95	x		15°	ø120	380	PP032.927SD	01 02 12 60 99
24,3	2700	2011	2370	95		x	24°	ø120	380	PP032.927F	01 02 12 60 99
24,3	2700	2011	2370	95	x		24°	ø120	380	PP032.927FD	01 02 12 60 99
24,3	2700	2095	2370	95		x	38°	ø120	380	PP032.927W	01 02 12 60 99
24,3	2700	2095	2370	95	x		38°	ø120	380	PP032.927WD	01 02 12 60 99
24,3	3000	2045	2545	95		x	15°	ø120	380	PP032.930S	01 02 12 60 99
24,3	3000	2045	2545	95	x		15°	ø120	380	PP032.930SD	01 02 12 60 99
24,3	3000	2160	2545	95		x	24°	ø120	380	PP032.930F	01 02 12 60 99
24,3	3000	2160	2545	95	x		24°	ø120	380	PP032.930FD	01 02 12 60 99
24,3	3000	2250	2545	95		x	38°	ø120	380	PP032.930W	01 02 12 60 99
24,3	3000	2250	2545	95	x		38°	ø120	380	PP032.930WD	01 02 12 60 99
375	2700	2547	3530	95			15°	ø120	380	PP033.927S	01 02 12 60 99
375	2700	2547	3530	95	x		15°	ø120	380	PP033.927SD	01 02 12 60 99
375	2700	2692	3530	95			24°	ø120	380	PP033.927F	01 02 12 60 99
375	2700	2692	3530	95	x		24°	ø120	380	PP033.927FD	01 02 12 60 99
375	2700	2817	3530	95			38°	ø120	380	PP033.927W	01 02 12 60 99
375	2700	2817	3530	95	x		38°	ø120	380	PP033.927WD	01 02 12 60 99
375	3000	2731	3785	95			15°	ø120	380	PP033.930S	01 02 12 60 99
375	3000	2731	3785	95	x		15°	ø120	380	PP033.930SD	01 02 12 60 99
375	3000	2886	3785	95			24°	ø120	380	PP033.930F	01 02 12 60 99
375	3000	2886	3785	95	x		24°	ø120	380	PP033.930FD	01 02 12 60 99
375	3000	3020	3785	95			38°	ø120	380	PP033.930W	01 02 12 60 99
375	3000	3020	3785	95	x		38°	ø120	380	PP033.930WD	01 02 12 60 99



Dali: Versione dimmerabile Dali / Dimmable Dali version / Versione dimmable Dali .  
DimTF: Versione dimmerabile Taglio di fase / Trailing/leading edge dimmable version / Versione dimmable corte de fase.



accessori - accessories  
accesorios pag.690

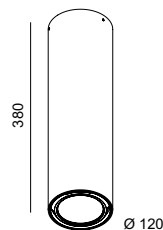

## SOFFITTO R90 OUTDOOR

CEILING - TECHO



	W	K	lm product	lm/Led	CRI	Dali	Dim.TF	∠	Dim.	H	CODE	Col.	
LED	17	2700	1438	1790	95		x	15°	ø90	300	PP421.927S	01 02 12 60 99	
	17	2700	1438	1790	95	x		15°	ø90	300	PP421.927SD	01 02 12 60 99	
	17	2700	1530	1790	95		x	24°	ø90	300	PP421.927F	01 02 12 60 99	
	17	2700	1530	1790	95	x		24°	ø90	300	PP421.927FD	01 02 12 60 99	
	17	2700	1609	1790	95		x	38°	ø90	300	PP421.927W	01 02 12 60 99	
	17	2700	1609	1790	95	x		38°	ø90	300	PP421.927WD	01 02 12 60 99	
	17	3000	1546	1925	95		x	15°	ø90	300	PP421.930S	01 02 12 60 99	
	17	3000	1546	1925	95	x		15°	ø90	300	PP421.930SD	01 02 12 60 99	
	17	3000	1645	1925	95		x	24°	ø90	300	PP421.930F	01 02 12 60 99	
	17	3000	1645	1925	95	x		24°	ø90	300	PP421.930FD	01 02 12 60 99	
	17	3000	1730	1925	95		x	38°	ø90	300	PP421.930W	01 02 12 60 99	
	17	3000	1730	1925	95	x		38°	ø90	300	PP421.930WD	01 02 12 60 99	
	3SDCM 50000h L90 B10 ta 25°C												
	A+												
QPAR16 GU10 230V	50								ø90	300	PP422	01 02 12 60 99	
A+-D													

Dali: Versione dimmerabile Dali / Dimmable Dali version / Versione dimmable Dali .

DimTF: Versione dimmerabile Taglio di fase / Trailing/leading edge dimmable version / Versione dimmable corte de fase.

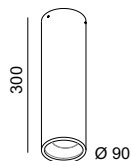

## SOFFITTO R120 OUTDOOR

CEILING - TECHO



	W	K	lm product	lm/Led	CRI	Dali	Dim.TF	∠	Dim.	H	CODE	Col.	
LED	24,3	2700	1904	2370	95		x	15°	ø120	380	PP432.927S	01 02 12 60 99	
	24,3	2700	1904	2370	95	x		15°	ø120	380	PP432.927SD	01 02 12 60 99	
	24,3	2700	2011	2370	95		x	24°	ø120	380	PP432.927F	01 02 12 60 99	
	24,3	2700	2011	2370	95	x		24°	ø120	380	PP432.927FD	01 02 12 60 99	
	24,3	2700	2095	2370	95		x	38°	ø120	380	PP432.927W	01 02 12 60 99	
	24,3	2700	2095	2370	95	x		38°	ø120	380	PP432.927WD	01 02 12 60 99	
	24,3	3000	2045	2545	95		x	15°	ø120	380	PP432.930S	01 02 12 60 99	
	24,3	3000	2045	2545	95	x		15°	ø120	380	PP432.930SD	01 02 12 60 99	
	24,3	3000	2160	2545	95		x	24°	ø120	380	PP432.930F	01 02 12 60 99	
	24,3	3000	2160	2545	95	x		24°	ø120	380	PP432.930FD	01 02 12 60 99	
	24,3	3000	2250	2545	95		x	38°	ø120	380	PP432.930W	01 02 12 60 99	
	24,3	3000	2250	2545	95	x		38°	ø120	380	PP432.930WD	01 02 12 60 99	
	3SDCM 50000h L90 B10 ta 25°C												
	A+												

Dali: Versione dimmerabile Dali / Dimmable Dali version / Versione dimmable Dali .

DimTF: Versione dimmerabile Taglio di fase / Trailing/leading edge dimmable version / Versione dimmable corte de fase.

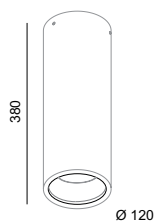

01 - bianco - white - blanco    02 - nero - black - negro    12 - grigio - grey - gris    60 - verniciato cor-ten - painted cor-ten - cor ten barnizado    99 - Grafite - Graphite - Grafito



pag.824



RISTORANTE FUSION CREMA - ITALY  
PROJECT ARCH. N.BOTTONI  
PHOTO R.MONTILLO





## I-PIPEDI R30S SOSPENSIONE

SUSPENSION - SUSPENSION

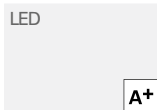

W	mA	K	lm product	lm/Led	CRI	∠
1,5	500	2700	252	145	80	16°
1,5	500	2700	136	145	80	30°
1,5	500	3000	252	145	80	16°
1,5	500	3000	136	145	80	30°

Dim.	H
ø30	700
ø30	700
ø30	700
ø30	700

CODE	Col.
PP101.827S	01 02 12 60 99
PP101.827F	01 02 12 60 99
PP101.830S	01 02 12 60 99
PP101.830F	01 02 12 60 99



## I-PIPEDI R55S SOSPENSIONE

SUSPENSION - SUSPENSION

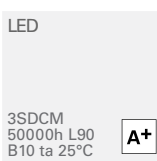

W	K	lm product	lm/Led	CRI	Dim.TF	∠
6,8	2700	321	480	>90		24°
6,8	2700	321	480	>90	x	24°
6,8	2700	437	480	>90		36°
6,8	2700	437	480	>90	x	36°
6,8	3000	330	494	>90		24°
6,8	3000	330	494	>90	x	24°
6,8	3000	450	494	>90		36°
6,8	3000	450	494	>90	x	36°

Dim.	H	Kg
ø55	300	1,26
ø55	300	1,26
ø55	300	1,26
ø55	300	1,26
ø55	300	1,26
ø55	300	1,26
ø55	300	1,26
ø55	300	1,26

CODE	Col.
PP111.927F	01 02 12 60 99
PP111.927FDF	01 02 12 60 99
PP111.927W	01 02 12 60 99
PP111.927WDF	01 02 12 60 99
PP111.930F	01 02 12 60 99
PP111.930FDF	01 02 12 60 99
PP111.930W	01 02 12 60 99
PP111.930WDF	01 02 12 60 99

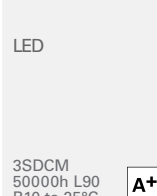

W	K	lm product	lm/Led	CRI	Dim.TF	∠
11	2700	703	1100	>90		25°
11	2700	703	1100	>90	x	25°
11	2700	1100	1100	>90		34°
11	2700	1100	1100	>90	x	34°
11	3000	757	1185	>90		25°
11	3000	757	1185	>90	x	25°
11	3000	1185	1185	>90		34°
11	3000	1185	1185	>90	x	34°

Dim.	H	Kg
ø55	300	1,26
ø55	300	1,26
ø55	300	1,26
ø55	300	1,26
ø55	300	1,26
ø55	300	1,26
ø55	300	1,26
ø55	300	1,26

CODE	Col.
PP112.927F	01 02 12 60 99
PP112.927FDF	01 02 12 60 99
PP112.927W	01 02 12 60 99
PP112.927WDF	01 02 12 60 99
PP112.930F	01 02 12 60 99
PP112.930FDF	01 02 12 60 99
PP112.930W	01 02 12 60 99
PP112.930WDF	01 02 12 60 99



W	Dim.	H	Kg	CODE	Col.
1x max 50	ø55	300	1,22	PP114	01 02 12 60 99

Dim.	H	Kg
ø55	300	1,22

CODE	Col.
PP114	01 02 12 60 99



W	Dim.	H	Kg	CODE	Col.
1x max 50	ø55	300	1,22	PP113	01 02 12 60 99

Dim.	H	Kg
ø55	300	1,22

CODE	Col.
PP113	01 02 12 60 99

DimTF: Versione dimmerabile Taglio di fase / Trailing/leading edge dimmable version / Versione dimmerabile corte de fase.

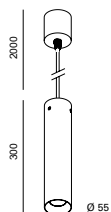

accessori - accessories  
accesorios pag. 690



# I-PIPEDI R90S SOSPENSIONE

SUSPENSION - SOSPENSION



LED	W	K	Im product	Im/Led	CRI	Dali	Dim.TF	∠	Dim.	H	CODE	Col.
	17	2700	1438	1790	95		x	15°	ø90	300	PP121.927S	01 02 12 60 99
	17	2700	1438	1790	95	x		15°	ø90	300	PP121.927SD	01 02 12 60 99
	17	2700	1530	1790	95		x	24°	ø90	300	PP121.927F	01 02 12 60 99
	17	2700	1530	1790	95	x		24°	ø90	300	PP121.927FD	01 02 12 60 99
	17	2700	1609	1790	95		x	38°	ø90	300	PP121.927W	01 02 12 60 99
	17	2700	1609	1790	95	x		38°	ø90	300	PP121.927WD	01 02 12 60 99
	17	3000	1546	1925	95		x	15°	ø90	300	PP121.930S	01 02 12 60 99
	17	3000	1546	1925	95	x		15°	ø90	300	PP121.930SD	01 02 12 60 99
	17	3000	1645	1925	95		x	24°	ø90	300	PP121.930F	01 02 12 60 99
	17	3000	1645	1925	95	x		24°	ø90	300	PP121.930FD	01 02 12 60 99
	17	3000	1730	1925	95		x	38°	ø90	300	PP121.930W	01 02 12 60 99
	17	3000	1730	1925	95	x		38°	ø90	300	PP121.930WD	01 02 12 60 99
	24,3	2700	1904	2370	95		x	15°	ø90	300	PP122.927S	01 02 12 60 99
	24,3	2700	1904	2370	95	x		15°	ø90	300	PP122.927SD	01 02 12 60 99
	24,3	2700	2011	2370	95		x	24°	ø90	300	PP122.927F	01 02 12 60 99
	24,3	2700	2011	2370	95	x		24°	ø90	300	PP122.927FD	01 02 12 60 99
	24,3	2700	2095	2370	95		x	38°	ø90	300	PP122.927W	01 02 12 60 99
	24,3	2700	2095	2370	95	x		38°	ø90	300	PP122.927WD	01 02 12 60 99
	24,3	3000	2045	2545	95		x	15°	ø90	300	PP122.930S	01 02 12 60 99
	24,3	3000	2045	2545	95	x		15°	ø90	300	PP122.930SD	01 02 12 60 99
	24,3	3000	2160	2545	95		x	24°	ø90	300	PP122.930F	01 02 12 60 99
	24,3	3000	2160	2545	95	x		24°	ø90	300	PP122.930FD	01 02 12 60 99
	24,3	3000	2250	2545	95		x	38°	ø90	300	PP122.930W	01 02 12 60 99
	24,3	3000	2250	2545	95	x		38°	ø90	300	PP122.930WD	01 02 12 60 99

3SDCM  
50000h L90  
B10 ta 25°C



QPAR16 GU10 230V	W	Dim.	H	CODE	Col.
1x max 50		ø90	300	PP123	01 02 12 60 99



Dali: Versione dimmerabile Dali / Dimmable Dali version / Versione dimmable Dali

DimTF: Versione dimmerabile Taglio di fase / Trailing/leading edge dimmable version / Versione dimmable corte de fase.

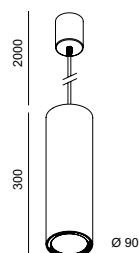

accessori - accessories  
accesorios pag. 690

# I-PIPEDI SOSPENSIONE R120S

SUSPENSION - SUSPENSION



LED

3SDCM  
50000h  
L90 B10 ta  
25°C



W	K	lm product	lm/Led	CRI	Dali	Dim.TF	∠	Dim.	H	CODE	Col.
17	2700	1438	1790	95		x	15°	ø120	380	PP131.927S	01 02 12 60 99
17	2700	1438	1790	95	x		15°	ø120	380	PP131.927SD	01 02 12 60 99
17	2700	1530	1790	95		x	24°	ø120	380	PP131.927F	01 02 12 60 99
17	2700	1530	1790	95	x		24°	ø120	380	PP131.927FD	01 02 12 60 99
17	2700	1609	1790	95		x	38°	ø120	380	PP131.927W	01 02 12 60 99
17	2700	1609	1790	95	x		38°	ø120	380	PP131.927WD	01 02 12 60 99
17	3000	1546	1925	95		x	15°	ø120	380	PP131.930S	01 02 12 60 99
17	3000	1546	1925	95	x		15°	ø120	380	PP131.930SD	01 02 12 60 99
17	3000	1645	1925	95		x	24°	ø120	380	PP131.930F	01 02 12 60 99
17	3000	1645	1925	95	x		24°	ø120	380	PP131.930FD	01 02 12 60 99
17	3000	1730	1925	95		x	38°	ø120	380	PP131.930W	01 02 12 60 99
17	3000	1730	1925	95	x		38°	ø120	380	PP131.930WD	01 02 12 60 99
24,3	2700	1904	2370	95		x	15°	ø120	380	PP132.927S	01 02 12 60 99
24,3	2700	1904	2370	95	x		15°	ø120	380	PP132.927SD	01 02 12 60 99
24,3	2700	2011	2370	95		x	24°	ø120	380	PP132.927F	01 02 12 60 99
24,3	2700	2011	2370	95	x		24°	ø120	380	PP132.927FD	01 02 12 60 99
24,3	2700	2095	2370	95		x	38°	ø120	380	PP132.927W	01 02 12 60 99
24,3	2700	2095	2370	95	x		38°	ø120	380	PP132.927WD	01 02 12 60 99
24,3	3000	2045	2545	95		x	15°	ø120	380	PP132.930S	01 02 12 60 99
24,3	3000	2045	2545	95	x		15°	ø120	380	PP132.930SD	01 02 12 60 99
24,3	3000	2160	2545	95		x	24°	ø120	380	PP132.930F	01 02 12 60 99
24,3	3000	2160	2545	95	x		24°	ø120	380	PP132.930FD	01 02 12 60 99
24,3	3000	2250	2545	95		x	38°	ø120	380	PP132.930W	01 02 12 60 99
24,3	3000	2250	2545	95	x		38°	ø120	380	PP132.930WD	01 02 12 60 99
375	2700	2547	3530	95			15°	ø120	380	PP133.927S	01 02 12 60 99
375	2700	2547	3530	95	x		15°	ø120	380	PP133.927SD	01 02 12 60 99
375	2700	2692	3530	95			24°	ø120	380	PP133.927F	01 02 12 60 99
375	2700	2692	3530	95	x		24°	ø120	380	PP133.927FD	01 02 12 60 99
375	2700	2817	3530	95			38°	ø120	380	PP133.927W	01 02 12 60 99
375	2700	2817	3530	95	x		38°	ø120	380	PP133.927WD	01 02 12 60 99
375	3000	2731	3785	95			15°	ø120	380	PP133.930S	01 02 12 60 99
375	3000	2731	3785	95	x		15°	ø120	380	PP133.930SD	01 02 12 60 99
375	3000	2886	3785	95			24°	ø120	380	PP133.930F	01 02 12 60 99
375	3000	2886	3785	95	x		24°	ø120	380	PP133.930FD	01 02 12 60 99
375	3000	3020	3785	95			38°	ø120	380	PP133.930W	01 02 12 60 99
375	3000	3020	3785	95	x		38°	ø120	380	PP133.930WD	01 02 12 60 99



Dali: Versione dimmerabile Dali / Dimmable Dali version / Versione dimmable Dali  
DimTF: Versione dimmerabile Taglio di fase / Trailing/leading edge dimmable version / Versione dimmable corte de fase.

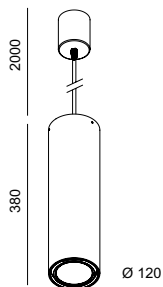

accessori - accessories  
acessorios pag. 690





TABAKALERA - CENTRO INTERNACIONAL DE CULTURA CONTEMPORÁNEA - SPAIN  
LIGHTING PROJECT TAO ILLUMINACION





WALL CEILING FLOOR

## I-PIPEDI R90A PARETE MONO EMISSIONE

SINGLE EMISSION WALL - PARED MONO EMISSION



LED

3SDCM  
50000h L90  
B10 ta 25°C

A+

W	K	lm product	lm/Led	CRI	Dali	Dim.TF	∠
17	2700	1438	1790	95		x	15°
17	2700	1438	1790	95	x		15°
17	2700	1530	1790	95		x	24°
17	2700	1530	1790	95	x		24°
17	2700	1609	1790	95		x	38°
17	2700	1609	1790	95	x		38°
17	3000	1546	1925	95		x	15°
17	3000	1546	1925	95	x		15°
17	3000	1645	1925	95		x	24°
17	3000	1645	1925	95	x		24°
17	3000	1730	1925	95		x	38°
17	3000	1730	1925	95	x		38°

Dim.	H
ø90	164
ø90	164
ø90	164
ø90	164
ø90	164
ø90	164
ø90	164
ø90	164
ø90	164
ø90	164
ø90	164
ø90	164
ø90	164
ø90	164
ø90	164

CODE	Col.
PP221.927S	01 02 12 60 99
PP221.927SD	01 02 12 60 99
PP221.927F	01 02 12 60 99
PP221.927FD	01 02 12 60 99
PP221.927W	01 02 12 60 99
PP221.927WD	01 02 12 60 99
PP221.930S	01 02 12 60 99
PP221.930SD	01 02 12 60 99
PP221.930F	01 02 12 60 99
PP221.930FD	01 02 12 60 99
PP221.930W	01 02 12 60 99
PP221.930WD	01 02 12 60 99



Dali : Versione dimmerabile Dali / Dimmable Dali version / Versione dimmable Dali  
DimTF: Versione dimmerabile Taglio di fase / Trailing/leading edge dimmable version / Versione dimmable corte de fase.



accessori - accessories  
accesorios pag. 690

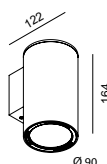

## I-PIPEDI R90A2 PARETE BI-EMISSIONE

DOUBLE EMISSION WALL - PARED BI-EMISSION



LED

3SDCM  
50000h L90  
B10 ta 25°C

A+

W	K	lm product	lm/Led	CRI	Dali	Dim.TF	∠
2x17	2700	2875	3580	95		x	15°
2x17	2700	2875	3580	95	x		15°
2x17	2700	3059	3580	95		x	24°
2x17	2700	3059	3580	95	x		24°
2x17	2700	3217	3580	95		x	38°
2x17	2700	3217	3580	95	x		38°
2x17	3000	3092	3850	95		x	15°
2x17	3000	3092	3850	95	x		15°
2x17	3000	3290	3850	95		x	24°
2x17	3000	3290	3850	95	x		24°
2x17	3000	3460	3850	95		x	38°
2x17	3000	3460	3850	95	x		38°

Dim.	H
ø90	260
ø90	260
ø90	260
ø90	260
ø90	260
ø90	260
ø90	260
ø90	260
ø90	260
ø90	260
ø90	260
ø90	260
ø90	260
ø90	260
ø90	260

CODE	Col.
PP321.927S	01 02 12 60 99
PP321.927SD	01 02 12 60 99
PP321.927F	01 02 12 60 99
PP321.927FD	01 02 12 60 99
PP321.927W	01 02 12 60 99
PP321.927WD	01 02 12 60 99
PP321.930S	01 02 12 60 99
PP321.930SD	01 02 12 60 99
PP321.930F	01 02 12 60 99
PP321.930FD	01 02 12 60 99
PP321.930W	01 02 12 60 99
PP321.930WD	01 02 12 60 99



Dali : Versione dimmerabile Dali / Dimmable Dali version / Versione dimmable Dali  
DimTF: Versione dimmerabile Taglio di fase / Trailing/leading edge dimmable version / Versione dimmable corte de fase.



accessori - accessories  
accesorios pag. 690

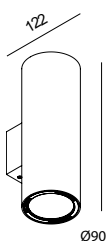

01 - bianco - white - blanco    02 - nero - black - negro    12 - grigio - grey - gris    60 - verniciato cor-ten - painted cor-ten - cor ten barnizado    99 - Grafite - Graphite - Grafito

# I-PIPEDI R120A PARETE MONO EMISSIONE

SINGLE EMISSION WALL - PARED MONO EMISION



	W	K	Im product	Im/Led	CRI	Dali	Dim.TF	∠	Dim.	H	CODE	Col.
LED	24,3	2700	1904	2370	95		x	15°	ø120	380	PP232.927S	01 12 02 60 99
	24,3	2700	1904	2370	95	x		15°	ø120	380	PP232.927SD	01 12 02 60 99
	24,3	2700	2011	2370	95		x	24°	ø120	380	PP232.927F	01 12 02 60 99
	24,3	2700	2011	2370	95	x		24°	ø120	380	PP232.927FD	01 12 02 60 99
	24,3	2700	2095	2370	95		x	38°	ø120	380	PP232.927W	01 12 02 60 99
	24,3	2700	2095	2370	95	x		38°	ø120	380	PP232.927WD	01 12 02 60 99
	24,3	3000	2045	2545	95		x	15°	ø120	380	PP232.930S	01 12 02 60 99
	24,3	3000	2045	2545	95	x		15°	ø120	380	PP232.930SD	01 12 02 60 99
	24,3	3000	2160	2545	95		x	24°	ø120	380	PP232.930F	01 12 02 60 99
	24,3	3000	2160	2545	95	x		24°	ø120	380	PP232.930FD	01 12 02 60 99
	24,3	3000	2250	2545	95		x	38°	ø120	380	PP232.930W	01 12 02 60 99
	24,3	3000	2250	2545	95	x		38°	ø120	380	PP232.930WD	01 12 02 60 99

Dali : Versione dimmerabile Dali / Dimmable Dali version / Versione dimmable Dali  
 DimTF: Versione dimmerabile Taglio di fase / Trailing/leading edge dimmable version / Versione dimmable corte de fase.



accessori - accessories  
 accesorios pag. 690

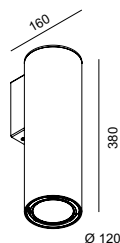

# I-PIPEDI R120A2 PARETE BI-EMISSIONE

DOUBLE EMISSION WALL - PARED BI-EMISION



	W	K	Im product	Im/Led	CRI	Dali	Dim.TF	∠	Dim.	H	CODE	Col.
LED	2x24,3	2700	3809	4740	95		x	15°	ø120	380	PP332.927S	01 02 12 60 99
	2x24,3	2700	3809	4740	95	x		15°	ø120	380	PP332.927SD	01 02 12 60 99
	2x24,3	2700	4023	4740	95		x	24°	ø120	380	PP332.927F	01 02 12 60 99
	2x24,3	2700	4023	4740	95	x		24°	ø120	380	PP332.927FD	01 02 12 60 99
	2x24,3	2700	4190	4740	95		x	38°	ø120	380	PP332.927W	01 02 12 60 99
	2x24,3	2700	4190	4740	95	x		38°	ø120	380	PP332.927WD	01 02 12 60 99
	2x24,3	3000	4090	5090	95		x	15°	ø120	380	PP332.930S	01 02 12 60 99
	2x24,3	3000	4090	5090	95	x		15°	ø120	380	PP332.930SD	01 02 12 60 99
	2x24,3	3000	4320	5090	95		x	24°	ø120	380	PP332.930F	01 02 12 60 99
	2x24,3	3000	4320	5090	95	x		24°	ø120	380	PP332.930FD	01 02 12 60 99
	2x24,3	3000	4500	5090	95		x	38°	ø120	380	PP332.930W	01 02 12 60 99
	2x24,3	3000	4500	5090	95	x		38°	ø120	380	PP332.930WD	01 02 12 60 99

Dali : Versione dimmerabile Dali / Dimmable Dali version / Versione dimmable Dali  
 DimTF: Versione dimmerabile Taglio di fase / Trailing/leading edge dimmable version / Versione dimmable corte de fase.



accessori - accessories  
 accesorios pag. 690

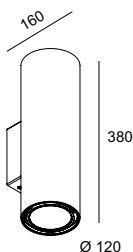

01 - bianco - white - blanco    02 - nero - black - negro    12 - grigio - grey - gris    60 - verniciato cor-ten - painted cor-ten - cor ten barnizado    99 - Grafite - Graphite - Grafito





## I-PIPEDI R90A MONO EMISSIONE OUTDOOR

PARETE MONO EMISSIONE - SINGLE EMISSION WALL-MOUNTED - PARED MONO EMISIÓN

	W	K	lm product	lm/Led	CRI	DaliTF	∠	Dim.	H	CODE	Col.
 <p>LED</p> <p>3SDCM 50000h L90 B10 ta 25°C</p> <p><b>A+</b></p>	17	2700	1438	1790	95		15°	ø90	160	PP521.927S	01 02 12 60 99
	17	2700	1438	1790	95	x	15°	ø90	160	PP521.927SD	01 02 12 60 99
	17	2700	1530	1790	95		24°	ø90	160	PP521.927F	01 02 12 60 99
	17	2700	1530	1790	95	x	24°	ø90	160	PP521.927FD	01 02 12 60 99
	17	2700	1609	1790	95		38°	ø90	160	PP521.927W	01 02 12 60 99
	17	2700	1609	1790	95	x	38°	ø90	160	PP521.927WD	01 02 12 60 99
	17	3000	1546	1925	95		15°	ø90	160	PP521.930S	01 02 12 60 99
	17	3000	1546	1925	95	x	15°	ø90	160	PP521.930SD	01 02 12 60 99
	17	3000	1645	1925	95		24°	ø90	160	PP521.930F	01 02 12 60 99
	17	3000	1645	1925	95	x	24°	ø90	160	PP521.930FD	01 02 12 60 99
	17	3000	1730	1925	95		38°	ø90	160	PP521.930W	01 02 12 60 99
	17	3000	1730	1925	95	x	38°	ø90	160	PP521.930WD	01 02 12 60 99



DimTF: Versione dimmerabile Taglio di fase / Trailing/leading edge dimmable version / Versione dimmable corte de fase.

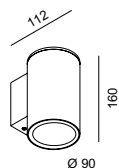

## I-PIPEDI R90A2 BI EMISSIONE OUTDOOR

PARETE BIEMISSIONE - DOUBLE EMISSION WALL-MOUNTED - PARED BIEMISSION

	W	K	lm product	lm/Led	CRI	DaliTF	∠	Dim.	H	CODE	Col.
 <p>LED</p> <p>3SDCM 50000h L90 B10 ta 25°C</p> <p><b>A+</b></p>	2x17	2700	2875	3580	95		15°	ø90	260	PP621.927S	01 02 12 60 99
	2x17	2700	2875	3580	95	x	15°	ø90	260	PP621.927SD	01 02 12 60 99
	2x17	2700	3059	3580	95		24°	ø90	260	PP621.927F	01 02 12 60 99
	2x17	2700	3059	3580	95	x	24°	ø90	260	PP621.927FD	01 02 12 60 99
	2x17	2700	3217	3580	95		38°	ø90	260	PP621.927W	01 02 12 60 99
	2x17	2700	3217	3580	95	x	38°	ø90	260	PP621.927WD	01 02 12 60 99
	2x17	3000	3092	3850	95		15°	ø90	260	PP621.930S	01 02 12 60 99
	2x17	3000	3092	3850	95	x	15°	ø90	260	PP621.930SD	01 02 12 60 99
	2x17	3000	3290	3850	95		24°	ø90	260	PP621.930F	01 02 12 60 99
	2x17	3000	3290	3850	95	x	24°	ø90	260	PP621.930FD	01 02 12 60 99
	2x17	3000	3460	3850	95		38°	ø90	260	PP621.930W	01 02 12 60 99
	2x17	3000	3460	3850	95	x	38°	ø90	260	PP621.930WD	01 02 12 60 99



DimTF: Versione dimmerabile Taglio di fase / Trailing/leading edge dimmable version / Versione dimmable corte de fase.

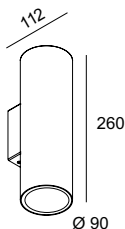

01 - bianco - white - blanco    02 - nero - black - negro    12 - grigio - grey - gris    60 - verniciato cor-ten/painted cor-ten barnizado cor-ten    99 - Grafite - Graphite - Grafito

## PARETE ESTERNO R120A MONO EMISSIONE OUTDOOR

PARETE MONO EMISSIONE - SINGLE EMISSION WALL-MOUNTED - PARED MONO EMISIÓN



LED

3SDCM  
50000h L90  
B10 ta 25°C

A+

W	K	lm product	lm/Led	CRI	△	Dim.	H	CODE	Col.
24,3	2700	1904	2370	95	15°	ø120	380	PP532.927S	01 12 02 60 99
24,3	2700	2011	2370	95	24°	ø120	380	PP532.927F	01 12 02 60 99
24,3	2700	2095	2370	95	38°	ø120	380	PP532.927W	01 12 02 60 99
24,3	2700	2011	2370	95	24°	ø120	380	PP532.927FDF	01 12 02 60 99
24,3	2700	2011	2370	95	24°	ø120	380	PP532.927FD	01 12 02 60 99
24,3	2700	1904	2370	95	15°	ø120	380	PP532.927SD	01 12 02 60 99
24,3	2700	1904	2370	95	15°	ø120	380	PP532.927SDF	01 12 02 60 99
24,3	2700	2095	2370	95	38°	ø120	380	PP532.927WDF	01 12 02 60 99
24,3	2700	2095	2370	95	38°	ø120	380	PP532.927WD	01 12 02 60 99
24,3	3000	2045	2545	95	15°	ø120	380	PP532.930S	01 12 02 60 99
24,3	3000	2160	2545	95	24°	ø120	380	PP532.930F	01 12 02 60 99
24,3	3000	2250	2545	95	38°	ø120	380	PP532.930W	01 12 02 60 99
24,3	3000	2160	2545	95	24°	ø120	380	PP532.930FD	01 12 02 60 99
24,3	3000	2160	2545	95	24°	ø120	380	PP532.930FDF	01 12 02 60 99
24,3	3000	2045	2545	95	15°	ø120	380	PP532.930SDF	01 12 02 60 99
24,3	3000	2045	2545	95	15°	ø120	380	PP532.930SD	01 12 02 60 99
24,3	3000	2250	2545	95	38°	ø120	380	PP532.930WDF	01 12 02 60 99
24,3	3000	2250	2545	95	38°	ø120	380	PP532.930WD	01 12 02 60 99

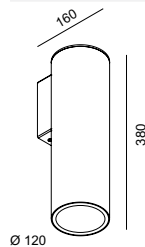

DimTF: Versione dimmerabile Taglio di fase / Trailing/leading edge dimmable version / Versione dimmable corte de fase.

## PARETE ESTERNO R120A2 BI EMISSIONE OUTDOOR

PARETE BIEMISSIONE- DOUBLE EMISSION WALL-MOUNTED - PARED BIEMISSION



LED

3SDCM  
50000h L90  
B10 ta 25°C

A+

W	K	lm product	lm/Led	CRI	△	Dim.	H	CODE	Col.
2x24,3	2700	3809	4740	95	15°	ø120	380	PP632.927S	01 02 12 60 99
2x24,3	2700	4023	4740	95	24°	ø120	380	PP632.927F	01 02 12 60 99
2x24,3	2700	4190	4740	95	38°	ø120	380	PP632.927W	01 02 12 60 99
2x24,3	2700	4023	4740	95	24°	ø120	380	PP632.927FDF	01 02 12 60 99
2x24,3	2700	4023	4740	95	24°	ø120	380	PP632.927FD	01 02 12 60 99
2x24,3	2700	3809	4740	95	15°	ø120	380	PP632.927SD	01 02 12 60 99
2x24,3	2700	3809	4740	95	15°	ø120	380	PP632.927SDF	01 02 12 60 99
2x24,3	2700	4190	4740	95	38°	ø120	380	PP632.927WDF	01 02 12 60 99
2x24,3	2700	4190	4740	95	38°	ø120	380	PP632.927WD	01 02 12 60 99
2x24,3	3000	4090	5090	95	15°	ø120	380	PP632.930S	01 02 12 60 99
2x24,3	3000	4320	5090	95	24°	ø120	380	PP632.930F	01 02 12 60 99
2x24,3	3000	4500	5090	95	38°	ø120	380	PP632.930W	01 02 12 60 99
2x24,3	3000	4320	5090	95	24°	ø120	380	PP632.930FD	01 02 12 60 99
2x24,3	3000	4320	5090	95	24°	ø120	380	PP632.930FDF	01 02 12 60 99
2x24,3	3000	4090	5090	95	15°	ø120	380	PP632.930SDF	01 02 12 60 99
2x24,3	3000	4090	5090	95	15°	ø120	380	PP632.930SD	01 02 12 60 99
2x24,3	3000	4500	5090	95	38°	ø120	380	PP632.930WDF	01 02 12 60 99
2x24,3	3000	4500	5090	95	38°	ø120	380	PP632.930WD	01 02 12 60 99

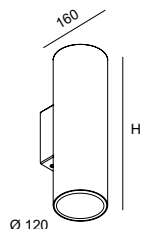

DimTF: Versione dimmerabile Taglio di fase / Trailing/leading edge dimmable version / Versione dimmable corte de fase.

01 - bianco - white - blanco    02 - nero - black - negro    12 - grigio - grey - gris    60 - verniciato cor-ten - painted cor-ten - cor ten barnizado    99 - Grafite - Graphite - Grafito

## RIFLETTORI

REFLECTORS - REFLECTORES



Optic	Dim.	Kg	CODE	Col.
15°	Ø 85	0,05	R085S.A	01 02
24°	Ø 85	0,05	R085FA	01 02
38°	Ø 85	0,05	R085WA	01 02
15°	Ø 115	0,05	R115S.A	01 02
24°	Ø 115	0,05	R115FA	01 02
38°	Ø 115	0,05	R115WA	01 02



## LENTI

LENSES - LENTES



ANELLO CON LENTE SATINATA / SATIN LENS WITH RING / ANILLO CON LENTE SATINADA

Dim.	Kg	CODE	Col.
Ø 85	0,02	L085SA	01 02
Ø 115	0,02	L115SA	01 02



ANELLO CON LENTE FRESNEL / FRESNEL LENS WITH RING / ANILLO CON LENTE FRESNEL

Dim.	Kg	CODE	Col.
Ø 85	0,02	L085FA	01 02
Ø 115	0,02	L115FA	01 02



ANELLO CON LENTE ELISSOIDALE / ELIPSOID LENS WITH RING / ANILLO CON LENTE ELIPSOIDAL

Dim.	Kg	CODE	Col.
Ø 85	0,02	L085EA	01 02
Ø 115	0,02	L115EA	01 02



ANELLO CON LENTE ASIMMETRICA / ASYMMETRIC LENS WITH RING / ANILLO CON LENTE ASIMÉTRICA

Dim.	Kg	CODE	Col.
Ø 85	0,02	L085AA	01 02
Ø 115	0,02	L115AA	01 02



FILTRO NIDO D'APE / HONEY COMB LOUVER WITH RING / ANILLO CON REJILLA DE NIDO DE ABEJA

Dim.	Kg	CODE	Col.
Ø 85	0,02	L085RA	01 02
Ø 115	0,02	L115RA	01 02



☐ 01 - bianco - white - blanco    ■ 02 - nero - black - negro



RISTORANTE NETTUNO RIMINI - ITALY  
PROJECT ARCH. M. MORANDI  
PHOTO M. FLORES

---

## FILE 2 COMPLEMENTI

Apparecchi a plafone per illuminazione diretta, completi di sorgenti LED professionali o per lampade alogene o LED QPAR16 GU10. Corpo quadrato o rettangolare in lamiera di acciaio verniciata. Completati di staffa per fissaggio a soffitto. Per le loro dimensioni, oltre che da soli, suggeriti in abbinamento a moduli finiti e profili File 2 e all'interno del Containers.

Ceiling-mounted fixtures for direct lighting. Complete with professional LED source or for 230V GU10 QPAR16 LED or halogen lamps. Square or rectangular body in painted steel. Complete with ceiling mounting bracket. The fixtures dimensions are studied to allow the use alone or within the Containers profile along with the FILE 2 profile family modules.

Aparatos a plafón para iluminación directa, con LED profesionales o para lámparas halógenas o LED QPAR16 GU10. Cuerpo cuadrado o rectangular en lámina de acero pintada. Con soporte de fijación al techo. Dadas sus dimensiones, además de solos, se sugiere su instalación en combinación con el perfil FILE2 y en el interior del perfil Containers.

---

## FILE2 COMPLEMENTI 1



	W	K	Im product	Im/Led	CRI	∠	Dim.	H	CODE	Col.	
LED 3SDCM 50000h L90 B10 ta 25°C <b>A+</b>	1x6,8	3000	330	494	>90	24°	78x78	110	LT2660.930F	01 02 49	
	1x6,8	3000	450	494	>90	36°	78x78	110	LT2660.930W	01 02 49	
	1x6,8	4000	363	544	>90	24°	78x78	110	LT2660.940F	01 02 49	
	1x6,8	4000	496	544	>90	36°	78x78	110	LT2660.940W	01 02 49	
QPAR16 GU10 230V <b>A+-D</b>	1x50						78x78	110	LT2660	01 02 49	

## FILE2 COMPLEMENTI 2



	W	K	Im product	Im/Led	CRI	∠	Dim.	H	CODE	Col.	
LED 3SDCM 50000h L90 B10 ta 25°C <b>A+</b>	2x6,8	3000	660	988	>90	24°	78x160	110	LT2661.930F	01 02 49	
	2x6,8	3000	900	988	>90	36°	78x160	110	LT2661.930W	01 02 49	
	2x6,8	4000	727	1088	>90	24°	78x160	110	LT2661.940F	01 02 49	
	2x6,8	4000	991	1088	>90	36°	78x160	110	LT2661.940W	01 02 49	
QPAR16 GU10 230V <b>A+-D</b>	2x50						78x160	110	LT2661	01 02 49	

## FILE2 COMPLEMENTI 3



	W	K	Im product	Im/Led	CRI	∠	Dim.	H	CODE	Col.	
LED 3SDCM 50000h L90 B10 ta 25°C <b>A+</b>	3x6,8	3000	990	1482	>90	24°	78x250	110	LT2662.930F	01 02 49	
	3x6,8	3000	1350	1482	>90	36°	78x250	110	LT2662.930W	01 02 49	
	3x6,8	4000	1090	1632	>90	24°	78x250	110	LT2662.940F	01 02 49	
	3x6,8	4000	1487	1632	>90	36°	78x250	110	LT2662.940W	01 02 49	
QPAR16 GU10 230V <b>A+-D</b>	3x50						78x250	110	LT2662	01 02 49	









Apparecchi a parete mono o biemissione per illuminazione d'accento e di evidenziazione di pareti e angoli. Gruppo ottico completo di sorgenti LED professionali, completo di alimentatore. Disponibili in versione ad angolo interno 90°, ad angolo esterno 270° e piatta. Corpo in metallo finitura verniciata. Grado di protezione IP40 e IP54.

Single or double-emission wall-mounted fixtures for accent lighting of planes or angles. Optical group complete with professional LED and electronic power-supply. Available in 90° internal angle, 270° external angle or flat. Body in painted metal. Degree of protection IP40 and IP54.

Aparatos de pared mono o biemisión para iluminación concentrada y para el resalte de paredes y ángulos. Grupo óptico con LED profesionales y alimentador electrónico. Disponible en versión con ángulo interno 90°, ángulo externo 270° y plano. Cuerpo en metal acabado barnizado. Grado de protección IP40 y IP54.

---



**MANINE**



WALL CEILING FLOOR





## MANINE 270-O BIEMISSIONE ORIZZONTALE

270-O HORIZONTAL DOUBLE EMISSION- 270-O BIDIRECCIONAL HORIZONTAL

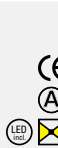
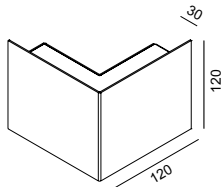
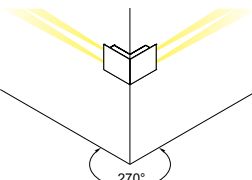
	W	K	lm product	lm/Led	CRI	IP	∠	Kg	CODE	Col.	
	4x1,5	3000	368	540	80	40	14°	0,82	<b>LT7000</b>	<b>01 60 99</b>	
	4x1,5	4000	395	580	80	40	14°	0,82	<b>LT7010</b>	<b>01 60 99</b>	
	4x1,5	3000	368	540	80	54	14°	0,92	<b>LT7001</b>	<b>01 60 99</b>	
	4x1,5	4000	395	580	80	54	14°	0,92	<b>LT7011</b>	<b>01 60 99</b>	
LED											
50000h L70 B10 ta 25°C											
<b>A+</b>											
											
											

## MANINE 270-V BIEMISSIONE VERTICALE

270-V VERTICAL DOUBLE EMISSION - 270-V BIDIRECCIONAL VERTICALES

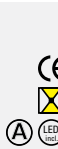
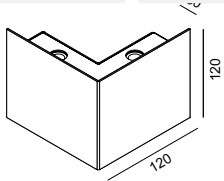
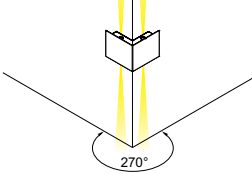
	W	K	lm product	lm/Led	CRI	IP	∠	Kg	CODE	Col.	
	4x1,5	3000	368	540	80	40	14°	0,82	<b>LT7004</b>	<b>01 60 99</b>	
	4x1,5	4000	395	580	80	40	14°	0,82	<b>LT7014</b>	<b>01 60 99</b>	
	4x1,5	3000	368	540	80	54	14°	0,92	<b>LT7005</b>	<b>01 60 99</b>	
	4x1,5	4000	395	580	80	54	14°	0,92	<b>LT7015</b>	<b>01 60 99</b>	
LED											
50000h L70 B10 ta 25°C											
<b>A+</b>											
											
											

## MANINE 270-V MONOEMISSIONE VERTICALE

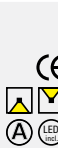
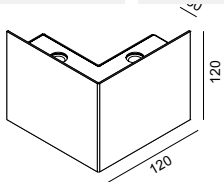
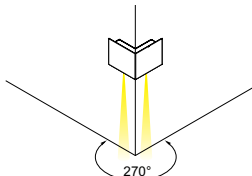

270-V VERTICAL SINGLE EMISSION- 270-V VERTICAL MONOEMISSION

	W	K	lm product	lm/Led	CRI	IP	∠	Kg	CODE	Col.	
	2x1,5	3000	184	270	80	40	14°	0,78	<b>LT7002</b>	<b>01 60 99</b>	
	2x1,5	4000	198	290	80	40	14°	0,78	<b>LT7012</b>	<b>01 60 99</b>	
	2x1,5	3000	184	270	80	54	14°	0,86	<b>LT7003</b>	<b>01 60 99</b>	
	2x1,5	4000	198	290	80	54	14°	0,86	<b>LT7013</b>	<b>01 60 99</b>	
LED											
50000h L70 B10 ta 25°C											
<b>A+</b>											
											
											



## MANINE 90-O BIEMISSIONE ORIZZONTALE

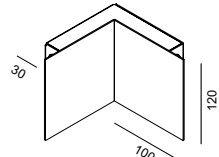
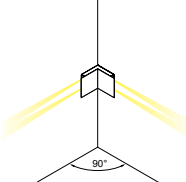

90-O HORIZONTAL DOUBLE EMISSION- 90-O BIDIRECCIONAL HORIZONTAL

	W	K	lm product	lm/Led	CRI	IP	∠	Kg	CODE	Col.	
LED	4x1,5	3000	368	540	80	40	14°	0,82	<b>LT7100</b>	<b>01 60 99</b>	  
	4x1,5	4000	395	580	80	40	14°	0,82	<b>LT7110</b>	<b>01 60 99</b>	
50000h L70 B10 ta 25°C	4x1,5	3000	368	540	80	54	14°	0,92	<b>LT7101</b>	<b>01 60 99</b>	
	4x1,5	4000	395	580	80	54	14°	0,92	<b>LT7111</b>	<b>01 60 99</b>	

## MANINE 90-V BIEMISSIONE VERTICALE



90-V VERTICAL DOUBLE EMISSION- 90-V EMISIÓN VERTICAL

	W	K	lm product	lm/Led	CRI	IP	∠	Kg	CODE	Col.	
LED	4x1,5	3000	368	540	80	40	14°	0,82	<b>LT7104</b>	<b>01 60 99</b>	  
	4x1,5	4000	395	580	80	40	14°	0,82	<b>LT7114</b>	<b>01 60 99</b>	
50000h L70 B10 ta 25°C	4x1,5	3000	368	540	80	54	14°	0,92	<b>LT7105</b>	<b>01 60 99</b>	
	4x1,5	4000	395	580	80	54	14°	0,92	<b>LT7115</b>	<b>01 60 99</b>	

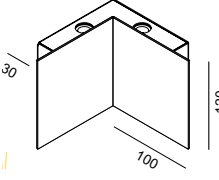
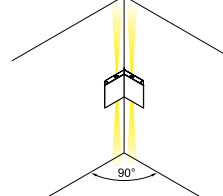
## MANINE 90-V MONOEMISSIONE VERTICALE

90-V SINGLE EMISSION - 90-V MONOEMISIÓN VERTICAL

	W	K	lm product	lm/Led	CRI	IP	∠	Kg	CODE	Col.	
LED	2x1,5	3000	184	270	80	40	14°	0,78	<b>LT7002</b>	<b>01 60 99</b>	  
	2x1,5	4000	198	290	80	40	14°	0,78	<b>LT7012</b>	<b>01 60 99</b>	
50000h L70 B10 ta 25°C	2x1,5	3000	184	270	80	54	14°	0,86	<b>LT7103</b>	<b>01 60 99</b>	
	2x1,5	4000	198	290	80	54	14°	0,86	<b>LT7113</b>	<b>01 60 99</b>	

WALL CEILING FLOOR

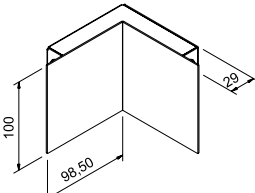
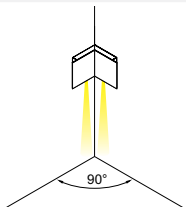



## MANINE PARETE MONO EMISSIONE

SINGLE EMISSION- PARED MONO EMISIÓN



	W	K	lm product	lm/Led	CRI	IP	∠	Kg	CODE	Col.
LED	2x1,5	3000	184	270	80	40	14°	0,52	<b>LT7200</b>	<b>01 60 99</b>
	2x1,5	4000	198	290	80	40	14°	0,52	<b>LT7210</b>	<b>01 60 99</b>
50000h L70 B10 ta 25°C	2x1,5	3000	184	270	80	54	14°	0,58	<b>LT7201</b>	<b>01 60 99</b>
	2x1,5	4000	198	290	80	54	14°	0,58	<b>LT7211</b>	<b>01 60 99</b>



Posizionabile anche in verticale. | possible to be installed vertically | Puede ser instalado verticalmente

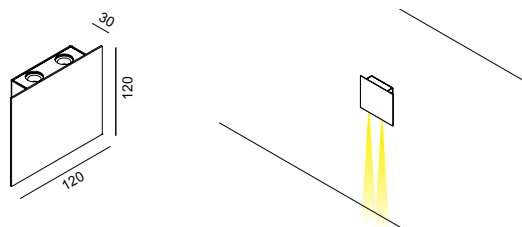

## MANINE PARETE BIEMISSIONE

DOUBLE EMISSION- PARED BI EMISIÓN



	W	K	lm product	lm/Led	CRI	IP	∠	Kg	CODE	Col.
LED	4x1,5	3000	368	540	80	40	14°	0,56	<b>LT7300</b>	<b>01 60 99</b>
	4x1,5	4000	395	580	80	40	14°	0,56	<b>LT7310</b>	<b>01 60 99</b>
50000h L70 B10 ta 25°C	4x1,5	3000	368	540	80	54	14°	0,65	<b>LT7301</b>	<b>01 60 99</b>
	4x1,5	4000	395	580	80	54	14°	0,65	<b>LT7311</b>	<b>01 60 99</b>



posizionabile anche in verticale. | possible to be installed vertically | puede ser nstalado verticalmente

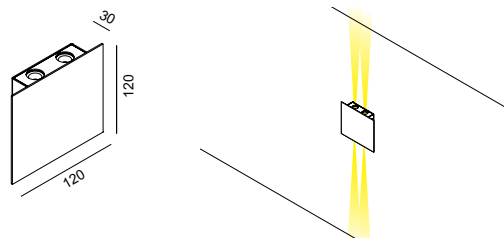



Applique architeturale a sorgente LED lineare. Caratterizzata da linea geometrica e dimensioni ultra-minimali, una volta installata diventa parte integrante dell'architettura. App-line, una piccola mensola con emissione luminosa indiretta. App-eal, una "L" con emissione luminosa indiretta. Corpo in alluminio pieno lavorato, finitura verniciata. Gruppo ottico completo di schermo di protezione satinato. Grado di protezione IP40.

Wall-mounted fixtures for indirect diffused lighting. Complete with 230V/240V professional linear LED sources. App-line, a little shelf with indirect lighting emission. App-eal "L" shaped with direct lighting emission. Body in painted milled aluminium. Optical group complete with frosted screen. Degree of protection IP40.

Aparatos de pared para iluminación indirecta difuminada, con LED profesionales dimerables 230V/240V. App-line emision luz indirecta. App-eal emision luz directa. Cuerpo en aluminio macizo, fresado, acabado pintado- Grupo óptico con pantalla de protección satinado. Grado de protección IP40.

---

**APP-LIQUES**



WALL CEILING FLOOR

## APP-LINE 1



	W	K	lm product	CRI	∠	Dim.	H	CODE	Col.	
LED 230V	13	3000	940	>80	110°	100x310	37	<b>APSB1</b>	<b>01</b>	
50000h L70 B10 ta 25°C	13	4000	960	>80	110°	100x310	37	<b>APSB2</b>	<b>01</b>	

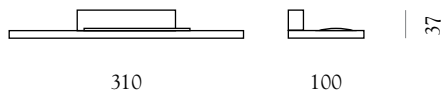

## APP-LINE 2



	W	K	lm product	CRI	∠	Dim.	H	CODE	Col.	
LED 230V	2x13	3000	1880	>80	110°	100x440	37	<b>APSB1</b>	<b>01</b>	
50000h L70 B10 ta 25°C	2x13	4000	1920	>80	110°	100x440	37	<b>APSB2</b>	<b>01</b>	

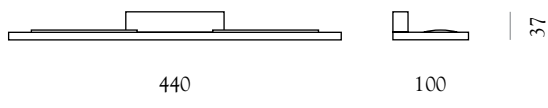

## APP-EAL 1



	W	K	lm product	CRI	∠	Dim.	H	CODE	Col.	
LED 230V 50000h L70 B10 ta 25°C	13	3000	940	>80	110°	100x210	110	APE01	01	
<b>A</b>	13	4000	960	>80	110°	100x210	110	APE02	01	

Dimmerabile a taglio di fase con dimmer dedicati tipo Vimar EvoEikon o equivalenti | Dimmable with phase cut dimmer dedicated Vimar EvoEikon or equivalent | regulable corte de fase con dimmer dedicada Vimar evo-eikon o equivalente.

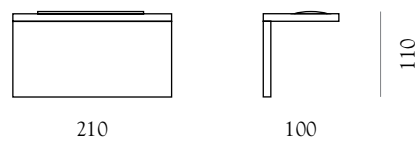

## APP-EAL 2



	W	K	lm product	CRI	∠	Dim.	H	CODE	Col.	
LED 230V 50000h L70 B10 ta 25°C	2x13	3000	1880	>80	110°	100x310	110	APEB1	01	
<b>A</b>	2x13	4000	1920	>80	110°	100x310	110	APEB2	01	

Dimmerabile a taglio di fase con dimmer dedicati tipo Vimar EvoEikon o equivalenti | Dimmable with phase cut dimmer dedicated Vimar EvoEikon or equivalent | regulable corte de fase con dimmer dedicada Vimar evo-eikon o equivalente.

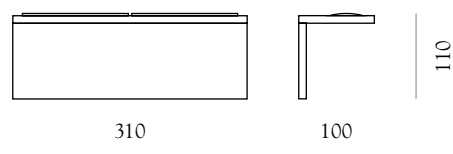

Apparecchi a parete per illuminazione diretta o diretta/indiretta, diffusa o diffusa/d'accento, completi di sorgenti LED professionali o per lampade alogene/LED QT14 c G9, QPAR16 GU10, QT-DE 12 114,2 mm. R7s o fluorescenti compatte TC-G24q-3 o TC-L 2G11 complete di gruppo di alimentazione 230V/240V magnetico o elettronico. Corpo in metallo finitura verniciata o acciaio satinato. Rigo 23, 23S, 50 e 60 complete di vetro di protezione satinato. Grado di protezione IP20 o IP40 a seconda dei modelli.

Wall-mounted fixtures for direct or direct/indirect, diffused or accent & diffused lighting. Complete with professional LED source or for 230V/240V G9 QT14 c , GU10 QPAR16, 114,2mm. R7s QT-DE 12 LED or halogen lamps or for G24q-3 and 2G11 TC-L compact fluorescent lamps complete with 230V/240V ballast. Body in painted metal or brushed steel. Versions Rigo 23, 23S, 50 and 60 complete with frosted protection glass. Degree of protection IP20 or IP40 according to the chosen model.

Aparatos de pared para iluminación directa o directa/indirecta, difuminada o difuminada/concentrada, con LED profesionales o para lámparas halógenas/LED QT14 c G9, QPAR16 GU10, QT-DE 12 114,2mm R7s o fluorescentes compactos G24q-3 o TC-L 2G11, con grupo de alimentación 230V/240V electrónico. Cuerpo en metal, acabo pintado o acero satinado. Rigo 23, 23S, 50 y 60 con cristal de protección satinado. Grado de protección IP20 o IP40 según modelos.

---



RIGO



WALL CEILING FLOOR





WALL CEILING FLOOR

## RIGO MINI G9

WALL/CEILING - PARED/TECHO



QT14 c G9 230V



D

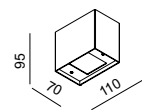

W

1 x max 60

CODE

Col.

LT1700

01 12 20 60 99



## RIGO MINI GU

WALL/CEILING - PARED/TECHO



QPAR16 GU10 230V



A<sup>+</sup>-D

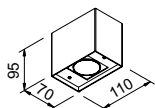

W

1 x max 50

CODE

Col.

LT1701







01 12 20 60 99



## RIGO 23S

WALL/CEILING - PARED/TECHO



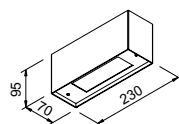

	W		CODE	Col.	
QTDE 12 R7s 230V mm114,2 	1 x max 120			<b>LT1703</b>	<b>01 12 20 60 99</b>
	1 x max 120			<b>LT1704</b>	<b>01 12 20 60 99</b>
	1 x max 150			<b>LT1705</b>	<b>01 12 20 60 99</b>
TC-DEL G24-t3 230V 	1 x 26			<b>LT1706</b>	<b>01 12 20 60 99</b>
	1 x 26			<b>LT1707</b>	<b>01 12 20 60 99</b>



## RIGO 23S GU

WALL/CEILING - PARED/TECHO



	W		CODE	Col.	
QPAR16 GU10 230V 	2 x Led/Halo max 50			<b>LT1702</b>	<b>01 12 20 60 99</b>

ATTENZIONE altezza lampadina max 57 mm. | WARNING bulb high max 57mm. | Altura maxima de la bombilla 57mm.

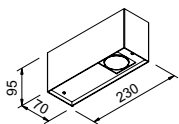

## RIGO 23

WALL/CEILING - PARED/TECHO



	W	K	lm product	lm/Led	CRI	∠	Dim.	H		CODE	Col.	
LED <b>A+</b>	6	3000	442	740	>90	120°	70x230	95		<b>LT17L02</b>	<b>01 12 20 60 99</b>	   
	6	3000	884	1480	>90	120°	70x230	95		<b>LT17LB2</b>	<b>01 12 20 60 99</b>	
QTDE 12 R7s 230V 118 mm.	1 x max 120						70x230	95		<b>LT1709</b>	<b>01 12 20 60 99</b>	  
	1 x max 120						70x230	95		<b>LT1710</b>	<b>01 12 20 60 99</b>	
TC-DEL G24-e3 230V <b>A→B</b>	1x26						70x230	95		<b>LT1711</b>	<b>01 12 20 60 99</b>	  
	1x26						70x230	95		<b>LT1712</b>	<b>01 12 20 60 99</b>	

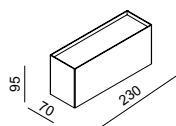

## RIGO 50

WALL/CEILING - PARED/TECHO



	W	K	lm product	lm/Led	CRI	∠	Dim.	H		CODE	Col.	
LED <b>A+</b>	6,5	3000	366	612	95	120°				<b>LT17L03</b>	<b>01 12 20 60 99</b>	   
	6,5	3000	731	1224	95	120°				<b>LT17LB3</b>	<b>01 12 20 60 99</b>	
TC-L 2G11 230V <b>A→B</b>	1x36									<b>LT1713</b>	<b>01 12 20 60 99</b>	  
	1x36									<b>LT1714</b>	<b>01 12 20 60 99</b>	
QTDE 12 R7S 230V 78 mm	2 x max 80									<b>LT1715.1</b>	<b>01 12 20 60 99</b>	  
	2 x max 80									<b>LT1715.2</b>	<b>01 12 20 60 99</b>	

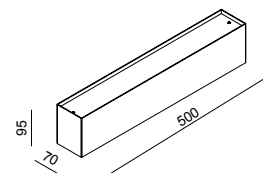

# RIGO 60

WALL/CEILING - PARED/TECHO



	W	K	lm product	lm/Led	CRI	∠		CODE	Col.	
LINEAR LED 24W/MT 2200LM/MT CRI>80 230V 50000h Ta 25° L70B10 <b>A+</b>	12,8	3000	736	1232	>80	120°		<b>LT17L04</b>	<b>01 12 20 60 99</b>	
	12,8	3000	736	1232	>80	120°		<b>LT17LB4</b>	<b>01 12 20 60 99</b>	
TC-L 2G11 230V <b>A-B</b>	1x55							<b>LT1716</b>	<b>01 12 20 60 99</b>	
	1x55							<b>LT1717</b>	<b>01 12 20 60 99</b>	

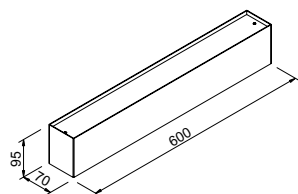



## SCENA

Apparecchi a sospensione, soffitto, parete, tavolo e terra per illuminazione diffusa, per lampade E14 ed E27 alogene, LED o fluorescenti compatte TC-TSE. Corpo cilindrico in metacrilato bianco opale delimitato alle estremità da diaframma in plexiglas trasparente. Completi di staffa per fissaggio a soffitto. Grado di protezione IP40.

Wall, suspension, table, floor and ceiling-mounted fixtures for diffused lighting. For 230V E14 or E27 LED, halogen or TC-TSE fluorescent lamps. Cylindrical body in opal white metacrylate and transparent metacrylate end caps. Complete with ceiling mounting bracket . IP40 degree of protection.

Aparato a plafón techo, pared, mesa o de pie para iluminación difuminada, para lámparas E14 y E27 halógenas, LED o fluorescentes compactos TC-TSE. Cuerpo cilíndrico en metacrilato blanco opal cerrado por los extremos con diafragma en metacrilato transparente. Con soporte de fijación en el techo. Grado de protección IP40.



















## SCENAMUTA

WALL/CEILING - PARED/TECHO



	W	Dim.	H	CODE	
QD45/QT26/TC-DSE E14 230V    A-D	1x max 40	ø110	220	<b>SCM20</b>	 
QA60/QT32/TC-TSE E27 230V    A-D	1x max 60 1x max 60 1x max 60	ø110 ø110 ø110	400 500 600	<b>SCM40</b> <b>SCM50</b> <b>SCM60</b>	 

Utilizzare lampade tubolari diametro max 40 mm. Possibilità di montare lampade fluorescenti compatte | Use tubular lamp diameter max 40mm. Chance to mount fluorescent lamp | Utilizar bombillas tubulares diametro maximo de 40 mm. Posibilidad de utilizar fluorescentes compactos.

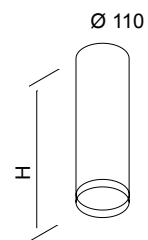

## SCENA S

SUSPENSION - SUSPENSION



	W	Dim.	H	CODE	
QD45/QT26/TC-DSE E14 230V    A-D	1x40	ø110	220	<b>SCS20</b>	 
QA60/QT32/TC-TSE E27 230V    A-D	1x max 60 1x max 60 1x max 60	ø110 ø110 ø110	400 500 600	<b>SCS40</b> <b>SCS50</b> <b>SCS60</b>	 

Utilizzare lampade tubolari diametro max 40 mm. Possibilità di montare lampade fluorescenti compatte | Use tubular lamp diameter max 40mm. Chance to mount fluorescent lamp | Utilizar bombillas tubulares diametro maximo de 40 mm. Posibilidad de utilizar fluorescentes compactos.

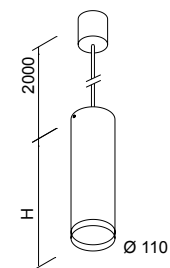

# SCENATA

SUSPENSION - SUSPENSION



T16 G5 230V	W	DaliT&D	Dim.	l	Lmm	CODE
	2x21-39 alim. elettronico/electronic ballast		ø110	400	954	<b>SC90</b>
	2x21-39	x	ø110	400	954	<b>SC90D</b>
	2x28-54 alim. elettronico/electronic ballast		ø110	400	1254	<b>SC120</b>
	2x28-54	x	ø110	400	1254	<b>SC120D</b>
	2x35-49		ø110	580	1554	<b>SC150</b>
	2x35-49	x	ø110	580	1554	<b>SC150D</b>

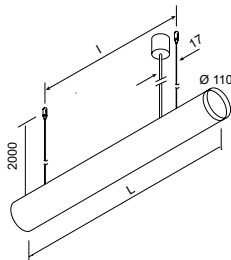

# SCENA TAVOLO

TABLE LAMP - LAMPARA DE PIE



OD45/OT26/TC-DSE E14 230V	W	Dim.	Lmm	CODE
	1x max 40	ø110	220	<b>SM20</b>
OA60/OT32/TC-TSE E27 230V	W	Dim.	Lmm	CODE
	1x max 60	ø110	400	<b>SM40</b>
	1x max 60	ø110	500	<b>SM50</b>
	1x max 60	ø110	600	<b>SM60</b>

Utilizzare lampade tubolari di diametro max. 40mm Possibilità di montare lampade fluorescenti compatte | Use tubular lamp diameter max 40mm. Chance to mount fluorescent lamp | Utilizar bombillas tubulares diametro maximo de 40 mm. Posibilidad de utilizar fluorescentes compactos.

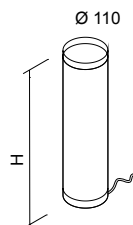

# TUTTASCENA

FLOOR LAMP - LAMPARA DE PIE



T16 G5 230V



A<sup>+</sup>-A

W

2x35-49

alimentatore elettronico/electronic ballast/balasto electronico

Dim.

ø110

Lmm

1800

CODE

TTS58

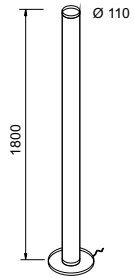





## STRUTTURA



Serie di apparecchi a sospensione, parete, plafone o terra per illuminazione d'accento, per lampade orientabili alogene o LED QR-LP 111 G53 12V/230V. Disponibili in versione con trasformatore elettronico 12V/230V incluso nel corpo lampada o alloggiato nella base accessorio. Gruppi ottici in metallo verniciato bianco o grigio. Gruppi ottici orientabili +/- 40° sugli assi orizzontali.

Serie of suspended, ceiling, wall-mounted or floor fixture for accent lighting. For 12V/230V G53 QR-LP 111 LED or halogen adjustable lamps. 12V/230V electronic transformer included within the fixture's body or within the metal base (accessory), included within the fixture's body. Body and optical groups in white or grey painted metal. Optical groups +/- 40° horizontally axis.

Aparato de suspensión, pared, techo o de pie para iluminación concentrada para lámpara s orientables halógenas o LED QR-LP111 G53 12V/230V. Disponible en versión con transformador electrónico 12V/230V alojado en el cuerpo de la lámpara o en la base accesoria. Cuerpo y grupos ópticos en metal barnizado blanco o gris. Grupos ópticos orientables de +/- 40° horizontal ejes.

## STRUTTURA 2 SOSPENSIONE

SUSPENSION - SUSPENSIÓN



QR-LP 111 G53 12V  
W  
2x Led/Halo max 60  
A→D

Kg  
1,8  
CODE  
SRS2  
Col.  
01 12



I trasformatori 230Vac/12Vac presentati in questo catalogo sono testati con i principali produttori di lampade LED. A causa della velocità dell'adeguamento tecnologico di queste ultime, Lucifero's non può garantire una compatibilità universale delle stesse con i propri trasformatori. | The 230Vac/12Vac transformers presented on this catalogue have been tested with the leading LED lamps manufacturers. Due to the pace of the technological update of them, Lucifero's cannot guarantee their universal compatibility with its transformers. | Los transformadores 230Vac/12Vac presentados en este catálogo han sido testados con los principales productores de lámparas LED. Debido a la rápida evolución tecnológica de estas, Lucifero's no puede garantizar una compatibilidad universal de las mismas con nuestros transformadores.

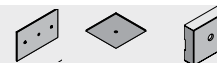
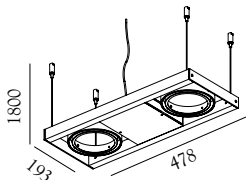

accessori - accessories - accesorios pag.729

## STRUTTURA 4 SOSPENSIONE

SUSPENSION - SUSPENSIÓN



QR-LP 111 G53 12V  
W  
4x Led/Halo max 50  
A→D

Kg  
2,6  
CODE  
SRS4  
Col.  
01 12



I trasformatori 230Vac/12Vac presentati in questo catalogo sono testati con i principali produttori di lampade LED. A causa della velocità dell'adeguamento tecnologico di queste ultime, Lucifero's non può garantire una compatibilità universale delle stesse con i propri trasformatori. | The 230Vac/12Vac transformers presented on this catalogue have been tested with the leading LED lamps manufacturers. Due to the pace of the technological update of them, Lucifero's cannot guarantee their universal compatibility with its transformers. | Los transformadores 230Vac/12Vac presentados en este catálogo han sido testados con los principales productores de lámparas LED. Debido a la rápida evolución tecnológica de estas, Lucifero's no puede garantizar una compatibilidad universal de las mismas con nuestros transformadores.

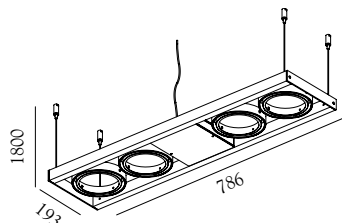

accessori - accessories - accesorios pag.729

01 - bianco - white - blanco 12 - grigio - grey - gris



pag.824

## STRUTTURA 2T SOFFITTO/PARETE

WALL/CEILING - PARED/TECHO

	W	Lmm	Kg	CODE	Col.	
 <p>QR-LP 111 G53 12V 2x Led/Halo max 50</p>	478	2,1	SRA2	01 12		



I trasformatori 230Vac/12Vac presentati in questo catalogo sono testati con i principali produttori di lampade LED. A causa della velocità dell'adeguamento tecnologico di queste ultime, Lucifero's non può garantire una compatibilità universale delle stesse con i propri trasformatori. | The 230Vac/12Vac transformers presented on this catalogue have been tested with the leading LED lamps manufacturers. Due to the pace of the technological update of them, Lucifero's cannot guarantee their universal compatibility with its transformers. | Los transformadores 230Vac/12Vac presentados en este catálogo han sido testados con los principales productores de lámparas LED. Debido a la rápida evolución tecnológica de estas, Lucifero's no puede garantizar una compatibilidad universal de las mismas con nuestros transformadores.



accessori - accessories - accesorios pag.729



## STRUTTURA 2 SOFFITTO/PARETE

WALL/CEILING - PARED/TECHO

	W	A	Lmm	Kg	CODE	Col.	
 <p>QR-LP 111 G53 12V 2x Led/Halo max 60</p>	328	T.2	1,2	SRA20	01 12		

Da completare con il trasformatore necessario | To complete with the necessary 230V/12v transformet | A completar con el transformador necesario

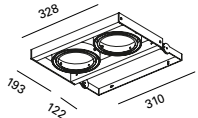

I trasformatori 230Vac/12Vac presentati in questo catalogo sono testati con i principali produttori di lampade LED. A causa della velocità dell'adeguamento tecnologico di queste ultime, Lucifero's non può garantire una compatibilità universale delle stesse con i propri trasformatori. | The 230Vac/12Vac transformers presented on this catalogue have been tested with the leading LED lamps manufacturers. Due to the pace of the technological update of them, Lucifero's cannot guarantee their universal compatibility with its transformers. | Los transformadores 230Vac/12Vac presentados en este catálogo han sido testados con los principales productores de lámparas LED. Debido a la rápida evolución tecnológica de estas, Lucifero's no puede garantizar una compatibilidad universal de las mismas con nuestros transformadores.

accessori - accessories - accesorios pag.729



## STRUTTURA 3 SOFFITTO/PARETE

WALL/CEILING - PARED/TECHO

	W	A	Lmm	Kg	CODE	Col.	
 <p>QR-LP 111 G53 12V 3x max 60</p>	482	T.2	1,6	SRA30	01 12		

Da completare con il trasformatore necessario | To complete with the necessary 230V/12v transformet | A completar con el transformador necesario

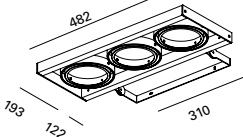
I trasformatori 230Vac/12Vac presentati in questo catalogo sono testati con i principali produttori di lampade LED. A causa della velocità dell'adeguamento tecnologico di queste ultime, Lucifero's non può garantire una compatibilità universale delle stesse con i propri trasformatori. | The 230Vac/12Vac transformers presented on this catalogue have been tested with the leading LED lamps manufacturers. Due to the pace of the technological update of them, Lucifero's cannot guarantee their universal compatibility with its transformers. | Los transformadores 230Vac/12Vac presentados en este catálogo han sido testados con los principales productores de lámparas LED. Debido a la rápida evolución tecnológica de estas, Lucifero's no puede garantizar una compatibilidad universal de las mismas con nuestros transformadores.

accessori - accessories - accesorios pag.729

01 - bianco - white - blanco 12 - grigio - grey - gris



 pag.824

**A** pag.820

## STRUTTURA 4T SOFFITTO/PARETE

WALL/CEILING - PARED/TECHO



QR-LP 111 G53 12V	W
 	4x Led/Halo max 50

Lmm	Kg	CODE	Col.
786	2,8	<b>SRA4</b>	<b>01 12</b>



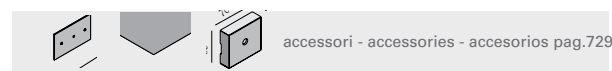
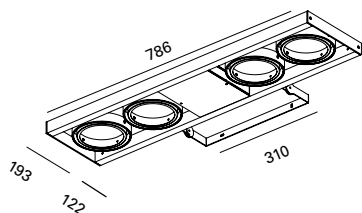

I trasformatori 230Vac/12Vac presentati in questo catalogo sono testati con i principali produttori di lampade LED. A causa della velocità dell'adeguamento tecnologico di queste ultime, Lucifero's non può garantire una compatibilità universale delle stesse con i propri trasformatori. | The 230Vac/12Vac transformers presented on this catalogue have been tested with the leading LED lamps manufacturers. Due to the pace of the technological update of them, Lucifero's cannot guarantee their universal compatibility with its transformers. | Los transformadores 230Vac/12Vac presentados en este catálogo han sido testados con los principales productores de lámparas LED. Debido a la rápida evolución tecnológica de estas, Lucifero's no puede garantizar una compatibilidad universal de las mismas con nuestros transformadores.



## STRUTTURA 5 SOFFITTO/PARETE

WALL/CEILING - PARED/TECHO



QR-LP 111 G53 12V	W
 	5x Led/Halo max 60

A	Lmm	Kg	CODE	Col.
<b>T.2</b>	790	2,2	<b>SRA50</b>	<b>01 12</b>



Da completare con il trasformatore necessario | To complete with the necessary 230V/12v transformet | A completar con el transformador necesario

I trasformatori 230Vac/12Vac presentati in questo catalogo sono testati con i principali produttori di lampade LED. A causa della velocità dell'adeguamento tecnologico di queste ultime, Lucifero's non può garantire una compatibilità universale delle stesse con i propri trasformatori. | The 230Vac/12Vac transformers presented on this catalogue have been tested with the leading LED lamps manufacturers. Due to the pace of the technological update of them, Lucifero's cannot guarantee their universal compatibility with its transformers. | Los transformadores 230Vac/12Vac presentados en este catálogo han sido testados con los principales productores de lámparas LED. Debido a la rápida evolución tecnológica de estas, Lucifero's no puede garantizar una compatibilidad universal de las mismas con nuestros transformadores.

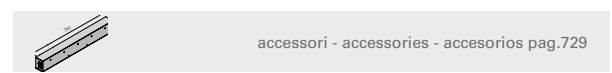
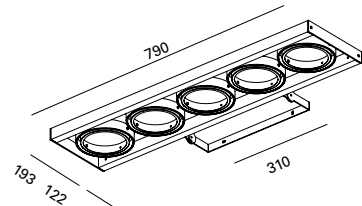

01 - bianco - white - blanco 12 - grigio - grey - gris

 pag.824

**A** pag.820

## STRUTTURA 4T TERRA

FLOOR - PIE



	W	H	Kg	CODE	Col.	
QR-LP 111 G53 12V	4x Led/halo max 50	2300	12,5	SRT4	01 12	

alimentatore elettronico incluso | electronic ballast included | balasto electrónico incluido

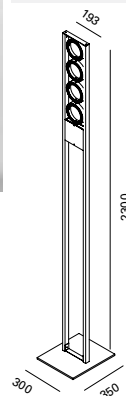

Compatibilità trasformatori 230V/12V con lampade LED. I trasformatori 230Vac/12Vac presentati in questo catalogo sono testati con i principali produttori di lampade LED. A causa della velocità dell'adeguamento tecnologico di queste ultime, Lucifero's non può garantire una compatibilità universale delle stesse con i propri trasformatori. Il peso massimo consentito delle lampade LED QR-LP 111 sui nostri proiettori è di 275 g. | 230V/12V transformer's compatibility with LED lamps : the 230Vac/12Vac transformers presented on this catalogue have been tested with the leading LED lamps manufacturers. Due to the pace of the technological update of them, Lucifero's cannot guarantee their universal compatibility with its transformers. The maximum allowed weight of 12V QR-LP 111 LED lamps is of 275 gr. | Compatibilidad transformadores 230V/12V con lamparas LED: los transformadores 230Vac/12Vac presentados en este catálogo han sido testados con los principales productores de lámparas LED. Debido a la rápida evolución tecnológica de estas, Lucifero's no puede garantizar una compatibilidad universal de las mismas con nuestros transformadores. El peso máximo admisible de las lámparas LED QR-LP 111 para nuestros proyectores es de 275gr.

## STRUTTURA TERRA 6T

FLOOR - PIE



	W	H	Kg	CODE	Col.	
QR-LP 111 G53 12V	6x Led/Halo max 50	2300	12,8	SRT6	01 12	

alimentatore elettronico incluso | electronic ballast included | balasto electrónico incluido

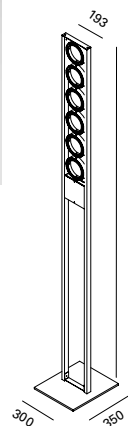

Compatibilità trasformatori 230V/12V con lampade LED. I trasformatori 230Vac/12Vac presentati in questo catalogo sono testati con i principali produttori di lampade LED. A causa della velocità dell'adeguamento tecnologico di queste ultime, Lucifero's non può garantire una compatibilità universale delle stesse con i propri trasformatori. Il peso massimo consentito delle lampade LED QR-LP 111 sui nostri proiettori è di 275 g. | 230V/12V transformer's compatibility with LED lamps : the 230Vac/12Vac transformers presented on this catalogue have been tested with the leading LED lamps manufacturers. Due to the pace of the technological update of them, Lucifero's cannot guarantee their universal compatibility with its transformers. The maximum allowed weight of 12V QR-LP 111 LED lamps is of 275 gr. | Compatibilidad transformadores 230V/12V con lamparas LED: los transformadores 230Vac/12Vac presentados en este catálogo han sido testados con los principales productores de lámparas LED. Debido a la rápida evolución tecnológica de estas, Lucifero's no puede garantizar una compatibilidad universal de las mismas con nuestros transformadores. El peso máximo admisible de las lámparas LED QR-LP 111 para nuestros proyectores es de 275gr.

01 - bianco - white - blanco 12 - grigio - grey - gris



pag.824

## PIASTRA DI CHIUSURA VANO ALLOGGIAMENTO TRASFORMATORI

BALLAST HOUSING'S COVER PLATE - PLACA PARA CAJA ALIMENTADORES.

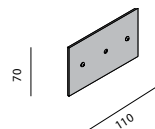

Per scatola 503 - For 503 wall box - Para caja 503

CODE	Col.
<b>C503</b>	<b>01 12</b>

## PIASTRA DI CHIUSURA SRA

PIASTRA DI CHIUSURA - COVER - PLATE PLACA FINAL CON MUELLE

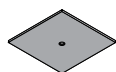

PER PARETI IN CARTONGESSO O PANNELLI IN CARTONGESSO. COMPLETA DI MOLLE. PER MODELLI PARETE/SOFFITTO | FOR PLASTERBOARD FALSE CEILING COMPLETE WITH SPRINGS. FOR WALL/ CEILING MODELS | PARA PAREDES O PANELES DE YESO COMPLETA DE MUELLES. PARA MODELOS PARED/TECHO.

Dim.
7X7
14X14

CODE	Col.
<b>DS2</b>	<b>01 12</b>
<b>DS3</b>	<b>01 12</b>

## SCATOLINA DI COPERTURA PER CODD.SRA2 SRA3

BOX TO COVER WIRING ON BRICKWORKS FOR REF. CODES SRA2 AND SRA4 - CAJA DE COBERTURA PARA EL CABLEADO PAR CODIGOS SRA2 Y SRA4

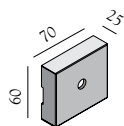

SCATOLINA DI COPERTURA PER CABLAGGI REALIZZATI PARETI IN MURATURA PER STRUTTURA PARETE/SOFFITTO COMPLETO DI TRASFORMATORI/ BOX TO COVER WIRING ON BRICKWORKS FOR WALL/CEILING MODELS WITH TRANSFORMER - CAJA DE COBERTURA PARA EL CABLEADO REALIZADOS EN PAREDES DE OBRA POR STRUTTURA PARED/TECHO CON TRASFORMADOR.

CODE	Col.
<b>SCA1</b>	<b>01 12</b>

## BOX PER ALLOGGIAMENTO TRASFORMATORI SRA20 SRA30

BOX PER ALLOGGIAMENTO TRASFORMATORI - HOUSING FOR HOSTING TRANSFORMERS. - CAJA POR BALASTO.

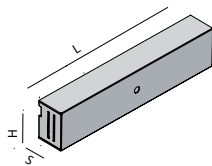

per - for - para code SRA20 e SRA30

per - for - para code SRA20 e SRA30

Lmm.	H	S	Kg	CODE	Col.
300	65	45	3,6	<b>CSA12V</b>	<b>01 12</b>
790	104	80	6,0	<b>CS.AST5</b>	<b>01 12</b>





ERNESTOMEDA LOFT MILANO - ITALY  
PROJECT ERNESTOMEDA







OUTDOOR

# RANGE

## OUTDOOR RANGE

iCEMENTI p.736



MANINE pag.748



FLIK FLOK p.754



iPIPEDI p.758



IN-OUT p.766



FILE 2 p.772



MICROFILE p.776



FORMAT p.782



STEP p.788



PIEDINI p.794





Famiglia di apparecchi da pavimento, soffitto, sospensione, soffitto e parete, per illuminazione diffusa o di orientamento e guida. Completi di sorgenti LED *chip on board* e alimentazione elettronica integrata 50/60Hz. Versioni da terra fornite di gruppo ottico in alluminio con emissione mono o bilaterale e piastra di montaggio in acciaio per il fissaggio a terra con blocco antifurto. Corpo in "CementoPiuma" VFRC (vinilic fiber reinforced concrete) cemento fibrato alleggerito. Schermo diffondente in PMMA opalino bianco (Zero51). Grado di protezione IP40 o IP65 a seconda dei modelli.

Family floor, suspended, ceiling and wall-mounted fittings for diffused or directional and guidance lighting. Complete with chip on board LED source and 50/60Hz built-in electronic driver. Floor versions supplied complete of aluminium optical unit with mono or bilateral light emission and steel mounting plate for fixing to the ground with anti-theft system. Body in VFRC (vinilic fiber reinforced concrete) "CementoPiuma" Diffusing screen in white opaline PMMA (Zero51). Degree of protection IP40 or IP65, according to the models.

Aparatos de suelo, suspensión, techo y pared iluminación difuminada o de señalización y guía. Completos de LED *chip on board* y alimentación electrónica integrada 50/60Hz. Modelos de suelo completos de grupo óptico en aluminio con emisión mono o bilateral y soporte de montaje en acero para la fijación en el suelo con bloque antirobo. Cuerpo en "CementoPiuma" VFRC (vinilic fiber reinforced concrete), cemento fibrato ligero. Pantalla en PMMA opal blanca (Zero51). Grado de protección IP40 o IP65, en función de los modelos.



ICEMENTI



OUTDOOR







Form follows function, that has been misunderstood.  
Form and function should be one, joined in a spiritual union.  
F. L. Wright



Una collezione di prodotti che parla il linguaggio dell'architettura, nati per offrire al progettista apparecchi di illuminazione e oggetti di arredo pensati per integrarsi in modo ideale con gli interni e con gli esterni di uno spazio progettato.

Lucifero's ha così scelto di investire in ricerca e sviluppo per trovare un materiale alternativo al metallo, il CementoPiuma, un materiale che ha l'aspetto del cemento ma che ne supera i limiti d'impiego legati al peso, perché composto solo in parte di cemento.

A collection of products that speaks the language of architecture, conceived to provide the designer with lighting appliances and furniture objects designed to be ideally integrated with the interior and exterior elements of a designed space.

Lucifero's has focused its research on the use of materials other than metal. CementoPiuma, a material that resembles concrete but that exceeds its limits of use in terms of weight because it is only partly made of cement.

Una colección de productos que habla el lenguaje de la arquitectura, creada para ofrecer al proyectista aparatos de iluminación y objetos de decoración pensados para integrarse de forma ideal con los espacios interiores y exteriores de un espacio proyectado.

Lucifero's eligió invertir en la investigación y el desarrollo para encontrar un material alternativo al metal, el CementoPiuma, que tiene semblanzas con el cemento, pero que supera sus limitaciones debidas al peso, ya que solo parcialmente está compuesto de cemento.

## i Cementi

## iCementi

Realizzati in un materiale innovativo, il CementoPioma, cemento fibrato alleggerito, che coniuga l'aspetto estetico, la sensazione tattile, la robustezza e la resistenza agli agenti atmosferici del cemento alla leggerezza e alla malleabilità produttiva, che rende possibile forme non realizzabili nel primo, iCementi si propongono come una gamma di apparecchi di illuminazione da interni e da esterni innovativi e funzionali.

## Leggerezza

iCementi pesano fino all'70% in meno di forme analoghe realizzate in cemento tradizionale. Il CementoPioma in cui sono realizzati ne determina un'eccezionale maneggevolezza, facilità di trasporto e di installazione che non hanno pari.

## Aspetto e sensazione tattile

Esteriormente iCementi si presentano pressoché identici ad oggetti realizzati in cemento pieno, sia nell'aspetto - anche per le irregolarità nella tonalità, che cambia con l'alternarsi delle stagioni per il diverso tasso di umidità presente nell'aria - sia al tatto, cui la superficie si presenta liscia ma materica.

## iCementi

Made from an innovative material, CementoPioma, lightweigh fiber concrete, which combines aesthetic appearance, tactile sensation, strength and resistance to weathering of the concrete with productive lightness and malleability, makes forms not initially feasible now possible, iCementi are offered as a range of innovative and functional indoor and outdoor lighting appliances.

## Lightness

iCementi weigh up to 70% less than similar forms made of traditional cement. CementoPioma from which they are made, confers them exceptional manoeuvrability together with ease of transportation and installation that is unparallel.

## Appearance and tactile sensation

Exteriorly iCementi are almost identical to objects made of solid concrete, both in terms of appearance - also due to the irregularities in the tonality, which changes with the seasons due to the different rate of humidity in the air - and to the touch, to which the surface is smooth yet material.

## iCementi

Realizados en un material novedoso CementoPioma, cemento fibrato ligero, que conjuga la estética, la sensación táctil, robustez y la resistencia a los agentes atmosféricos propio del cemento, a la ligereza y a la maleabilidad productiva, que permiten realiazar formas, irrealizables con el cemento tradicional, I CEMENTI se proponen como una gama de aparatos de iluminación para interior y exterior, novedosos y funcionales.

## Ligereza

iCementi pesan hasta un 70% menos que las mismas piezas realizadas en cemento tradicional. El CementoPioma confiere una excepcional manipulación, facilidad de transporte y de instalación sin precedentes.

## Aspecto y sensación táctil

Exteriormente iCementi presenta un aspecto prácticamente idéntico a un producto realizado en cemento macizo, tanto visualmente, como por las irregularidades en las tonalidades, que cambian con el paso de las estaciones debido a las diferentes tasas de humedad presentes en el aire, así como al tacto, cuya superficie se presenta lisa pero con la misma textura del cemento.



## Robustezza e resistenza agli agenti atmosferici

Il CementoPiuma conferisce a iCementi un grado di robustezza e di resistenza sia agli urti che agli agenti atmosferici pari a quella del cemento pieno. La superficie non è idrofuga ma la miscelazione dello strato di cemento esterno con sabbia ad alto tasso di silicio rende iCementi meno propensi all'assorbimento dell'acqua del calcestruzzo tradizionale.

## Facilità di installazione

I prodotti della collezione sono forniti già internamente cablati per l'installazione, come qualsiasi altro apparecchio di illuminazione, aspetto questo di particolare importanza nel caso di prodotti di una certa dimensione, perché ne semplifica l'installazione elettrica.

## Tecnologia LED

In linea con i tempi, l'intera collezione è studiata per alloggiare sorgenti LED di ultima generazione e, nel caso degli apparecchi di maggiori dimensioni, anche fluorescenti, per assicurare il massimo risparmio energetico, la minimizzazione della manutenzione e il rispetto dell'ambiente.

## Strength and resistance to weathering

CementoPiuma provides iCementi with a degree of strength and resistance both to knocks and weathering equal to that of solid cement. The surface is not hydrophobic but the external layer's blend of concrete with high silicon rate sand makes iCementi less prone than traditional concrete to the absorption of water.

## Ease of installation

The products of the collection are supplied already internally wired for installation, as any other lighting appliance, an aspect of particular importance in the case of products of a certain size, because it simplifies their electrical installation.

## LED technology

In line with the times, the entire collection is designed to accommodate latest generation LED sources and, in the case of larger size appliances, also fluorescent, to ensure maximum energy savings, a minimisation of maintenance and respect for the environment.

## Robustez y resistencia a los agentes atmosféricos

El CementoPiuma confiere a iCementi un grado de robustez y de resistencia tanto a los golpes como a los agentes atmosféricos parecidos a los del cemento macizo. Lo superficie no es hidrófuga, pero la mezcla de cemento con un alto porcentaje de arenas con un alto contenido de sílice hace que iCementi absorban menos el agua que el hormigón

## Facilidad de instalación

Los productos de la colección se suministran totalmente cableados listos para instalar, como cualquier otro aparato de iluminación, aspecto éste de particular importancia en aparatos de un cierto volumen, ya que simplifica su instalación eléctrica.

## Tecnología LED

La totalidad de la colección está estudiada para utilizar fuentes de luz LED de última generación, de acuerdo con los tiempos actuales y, en los casos de los aparatos de mayores dimensiones, también con fluorescentes, a fin de asegurar el máximo ahorro energético, el mínimo de manutención y el respeto al medio ambiente.



## MONOLYTE

TERRA - FLOOR - PIE



LED	W	K	lm product	lm/Led	CRI	Dim.	H	Kg	CODE	
A+	3	3000	85	270	80	150x250	600	22	IC0201.830 IC0201.840	
	3	4000	91	290	80	150x250	600	22		

## CENTO3CENTO

TERRA - FLOOR - PIE



LED	W	K	lm product	lm/Led	CRI	Dim.	H	Kg	CODE	
A+	3	3000	70	270	80	100x300	250	78	IC0101.830 IC0101.840	
	3	4000	75	290	80	100x300	250	78		

## PASTORALE

TERRA - FLOOR - PIE



LED	W	K	lm product	lm/Led	CRI	Dim.	H	Kg	CODE	
A+	3	3000	150	270	80	200x200	350	9	IC0301.830 IC0301.840 IC0302.830 IC0302.840	
	3	4000	161	290	80	200x200	350	9		
	6	3000	300	540	80	200x200	800	13		
	6	4000	322	580	80	200x200	800	13		

# PANCA

TERRA - FLOOR - PIE



LINEAR LED IP65 14,4W/ MT 60LED/MT 24V	W	K	lm product	lm/Led	CRI	Dim.	H	Kg	CODE	
A+	172	3000	650	1080	80	1500x450	450	39	IC0501.830 IC0501.840	
	172	4000	693	1152	80	1500x450	450	39		
						Dim.	H	Kg	CODE	
						1500x450	450	37	IC0502**	

Seduta conforme alla normativa UNI 11306 del 02.2009./ Degree of protection IP65. Seat conforms to standard UNI 11306 of 02.2009 / Asiento conforme a la normativa UNI 11306 del 02.2009.

\*\* versione non elettrificata / non-electrified version / versión no electrificada

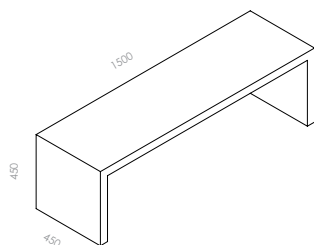

# PANCHETTO

TERRA - FLOOR - PIE



LED	W	K	lm product	lm/Led	CRI	Dim.	H	Kg	CODE	
A+	3	3000	150	270	80	450x450	450	22	IC0401.830 IC0401.840	
	3	4000	161	290	80	450x450	450	22		
						Dim.	H	Kg	CODE	
						450x450	450	20	IC0402**	

Seduta conforme alla normativa UNI 11306 del 02.2009./ Degree of protection IP65. Seat conforms to standard UNI 11306 of 02.2009 / Asiento conforme a la normativa UNI 11306 del 02.2009.

\*\* versione non elettrificata / non-electrified version / version non-électrifiée / version ohne Elektrik / versión no electrificada

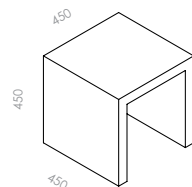

OUTDOOR

## BRIQUE V

PARETE - WALL - PARED



	W	K	lm product	lm/Led	CRI	Dim.	H	Kg	CODE	
LED	6	3000	300	540	80	120x100	200	2,2	<b>IC1101.830</b>	
	6	4000	322	580	80	120x100	200	2,2	<b>IC1101.840</b>	

	W	K	lm product	lm/Led	CRI	Dim.	H	Kg	CODE	
LED	6+6	3000	600	1080	80	120x100	200	2,5	<b>IC1102.830</b>	
	6+6	4000	644	1160	80	120x100	200	2,5	<b>IC1102.840</b>	

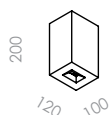

## BRIQUE O

PARETE - WALL - PARED



	W	K	lm product	lm/Led	CRI	Dim.	H	Kg	CODE	
LED	6	3000	300	540	80	120x250	80	2,6	<b>IC1001.830</b>	
	6	4000	322	580	80	120x250	80	2,6	<b>IC1001.840</b>	

	W	K	lm product	lm/Led	CRI	Dim.	H	Kg	CODE	
LED	6+6	3000	600	1080	80	120x250	80	2,8	<b>IC1002.830</b>	
	6+6	4000	644	1160	80	120x250	80	2,8	<b>IC1002.840</b>	

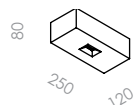



Apparecchi a parete mono o biemissione per illuminazione d'accento e di evidenziazione di pareti e angoli. Gruppo ottico completo di sorgenti LED professionali e alimentatore elettronico. Disponibili in versione ad angolo interno 90°, ad angolo esterno 270° e piatta. Corpo in metallo finitura verniciata. Grado di protezione IP54.

Single or double-emission wall-mounted fixtures for accent lighting of planes or angles. Optical group complete with professional LED and electronic power-supply. Available in 90° internal angle, 270° external angle or flat. Body in painted metal. Degree of protection IP54.

Aparatos de pared mono o biemisión para iluminación concentrada y para el resalte de paredes y ángulos. Grupo óptico con LED profesionales y alimentador electrónico. Disponible en versión con ángulo interno 90°, ángulo externo 270° y plano. Cuerpo en metal acabado barnizado. Grado de protección IP54.

---

MANINE



OUTDOOR

## MANINE 270-O BI EMISSIONE ORIZZONTALE

270-O HORIZONTAL DOUBLE EMISSION- 270-O BIDIRECCIONAL HORIZONTAL



LED  
50000h L70  
B10 ta 25°C

A+

W	K	lm product	lm/Led	CRI	△
4x1,5	3000	368	540	80	14°
4x1,5	4000	395	580	80	14°

Kg	CODE	Col.
0,92	LT7001	01 60 99
0,92	LT7011	01 60 99

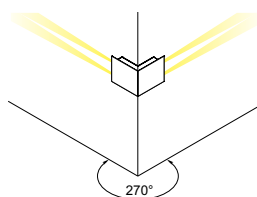
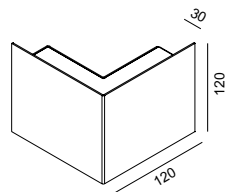

## MANINE 270-V BI EMISSIONE VERTICALE

270-V VERTICAL DOUBLE EMISSION - 270-V BIDIRECCIONAL VERTICALES

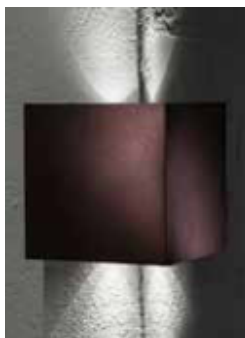

LED  
50000h L70  
B10 ta 25°C

A+

W	K	lm product	lm/Led	CRI	△
4x1,5	3000	368	540	80	14°
4x1,5	4000	395	580	80	14°

Kg	CODE	Col.
0,92	LT7005	01 60 99
0,92	LT7015	01 60 99

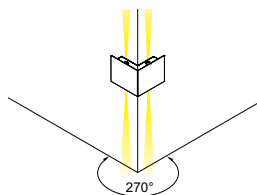
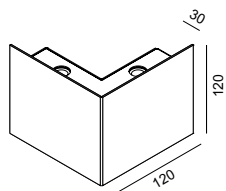

## MANINE 270-V MONO EMISSIONE VERTICALE

VERTICAL SINGLE EMISSION- 270-V VERTICAL MONOEMISSION



LED  
50000h L70  
B10 ta 25°C

A+

W	K	lm product	lm/Led	CRI	△
2x1,5	3000	184	270	80	14°
2x1,5	4000	198	290	80	14°

Kg	CODE	Col.
0,86	LT7003	01 60 99
0,86	LT7013	01 60 99

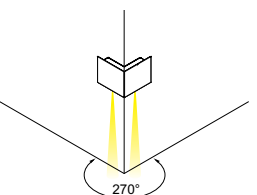
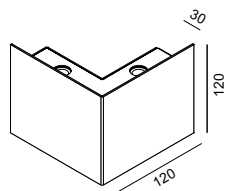

01 - bianco - white - blanco

60 - verniciato corten - painted corten - barnizado corten

99 - Grafite - Graphite - Grafito



pag.824



## MANINE 90-O BI EMISSIONE ORIZZONTALE

90-O HORIZONTAL DOUBLE EMISSION- 90-O BIEMISIÓN HORIZONTAL



LED  
50000h L70  
B10 ta 25°C

A+

W	K	Im product	Im/Led	CRI	∠
4x1,5	3000	368	540	80	14°
4x1,5	4000	395	580	80	14°

Kg	CODE	Col.
0,92	LT7101	01 60 99
0,92	LT7111	01 60 99

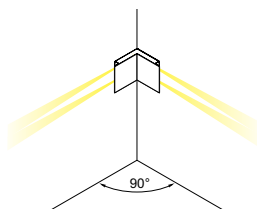
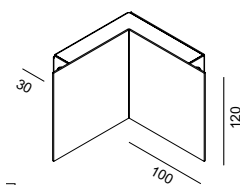

## MANINE 90-V BI EMISSIONE VERTICALE

90-V VERTICAL DOUBLE EMISSION- 90-V BIEMISIÓN VERTICAL



LED  
50000h L70  
B10 ta 25°C

A+

W	K	Im product	Im/Led	CRI	∠
4x1,5	3000	368	540	80	14°
4x1,5	4000	395	580	80	14°

Kg	CODE	Col.
0,92	LT7105	01 60 99
0,92	LT7115	01 60 99

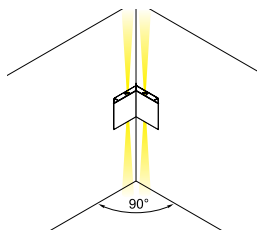
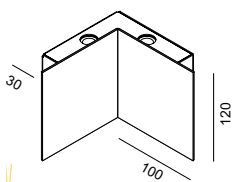

## MANINE 90-V MONO EMISSIONE VERTICALE

90-V VERTICAL SINGLE EMISSION- 90-V VERTICAL MONOEMISIÓN



LED  
50000h L70  
B10 ta 25°C

A+

W	K	Im product	Im/Led	CRI	∠
2x1,5	3000	184	270	80	14°
2x1,5	4000	198	290	80	14°

Kg	CODE	Col.
0,86	LT7103	01 60 99
0,86	LT7113	01 60 99

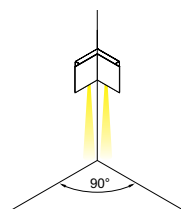
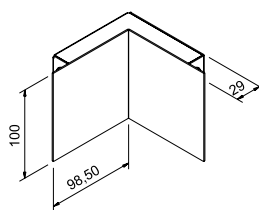

01 - bianco - white - blanco ■ 60 - verniciato corten - painted corten - barnizado corten ■ 99 - Grafite - Graphite - Grafito

## MANINE OUTDOOR PARETE MONO EMISSIONE

SINGLE EMISSION- PARED MONOEMISSION



	W	K	lm product	lm/Led	CRI	∠	Kg	CODE	Col.	
LED	2x1,5	3000	184	270	80	14°	0,58	<b>LT7201</b>	<b>01 60 99</b>	 
50000h L70 B10 ta 25°C	2x1,5	4000	198	290	80	14°	0,58	<b>LT7211</b>	<b>01 60 99</b>	

posizionabile anche in verticale. | possible to be installed vertically | Puede ser instalado verticalmente

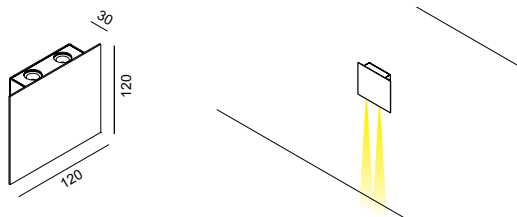

## MANINE OUTDOOR PARETE BI EMISSIONE

DOUBLE EMISSION- PARED BIEMISSION



	W	K	lm product	lm/Led	CRI	∠	Kg	CODE	Col.	
LED	4x1,5	3000	368	540	80	14°	0,65	<b>LT7301</b>	<b>01 60 99</b>	 
50000h L70 B10 ta 25°C	4x1,5	4000	395	580	80	14°	0,65	<b>LT7311</b>	<b>01 60 99</b>	

posizionabile anche in verticale. | possible to be installed vertically | puede ser nstalado verticalmente

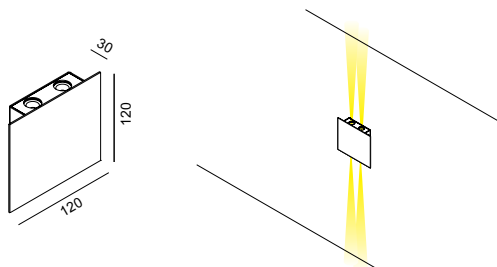



Apparecchi a parete per illuminazione diretta o indiretta, completi di sorgenti lineari LED. Da completare con alimentatore elettronico da installare remoto. Corpo in estruso di alluminio. Doppia possibilità di installazione: se fissati per il lato corto l'illuminazione è diffusa, se fissati per quello largo l'illuminazione è più radente. Completi di testate di chiusura laterali con sistema Light Proof, schermi diffondenti in PC opalino bianco e staffe di fissaggio. Grado di protezione IP54.

Series of wall-mounted fixtures for direct or indirect lighting, complete with integrated linear LED sources. To be completed with driver, to be installed remote. Body in extruded aluminium. Double installation possibility: if fixed by the narrow side, the lighting effect is diffused, if fixed instead by the wide side, the lighting is grazing. Complete with Light Proof system side end caps, opal white PC diffuser and mounting brackets. IP54 degree of protection.

Aparatos de pared para iluminación directa o indirecta, completo de fuentes de luz lineales LED. Se debe completar con alimentador electrónico a instalar remoto. Cuerpo en estruso de aluminio, acabado barnizado. Doble posibilidad de instalación: si se fija por el lado estrecho (Flok) la iluminación es difuminada, si se fija por el lado ancho (flik) la iluminación es más directa. Tapas laterales con sistema "Light Proof", difusores en policarbonato opal blanco y soportes de fijación. Grado de protección IP54

---



**FLIK - FLOK**

OUTDOOR

755

# FLIK - FLOK PARETE OUTDOOR

PARETE - WALL - PARED



	W	K	lm product	lm/Led	CRI	A	Lmm	CODE	Col.	
LINEAR LED <b>A+</b>	1x6	3000	312	522	>80	V.1	110	FF06	01 60	



	W	K	lm product	lm/Led	CRI	A	Lmm	CODE	Col.	
LINEAR LED 24W/MT 2200LM/MT CRI>80 <b>A+</b>	1x6,4	3000	478	800	>80	7.1	290	FF07	01 60	

Alimentazione remota non inclusa. Da completare con il relativo alimentatore. | Remote ballast not included. To be completed with the relative ballast.

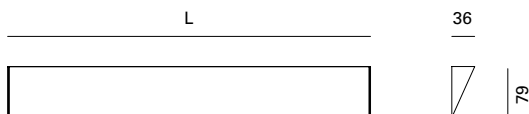







Apparecchi a plafone e parete per illuminazione diretta, completi di sorgenti LED professionali. Completi di gruppo di alimentazione 230V/240V elettronici. Corpo cilindrico in estruso di alluminio finitura verniciata. Completi di staffa per fissaggio a soffitto. Grado di protezione IP54.

Ceiling and wall-mounted fixtures for direct lighting. Complete with professional LED source. Complete with 230V/240V control-gear box. Cylindrical body in painted extruded aluminium. Complete with ceiling mounting bracket. IP54 degree of protection.

Aparatos a plafón y pared para iluminación directa o directa/indirecta, con LED profesionales. Con transformador 12V/230V o grupo de alimentación 230V/240V electrónicos. Cuerpo cilíndrico en estruso de aluminio, acabado barnizado. Con base de fijación al techo. Grado de protección IP54.

---

---

**I-PIEDI OUTDOOR**



OUTDOOR











SCUOLA DELL'INFANZIA ZOLINO - ITALY  
PROJECT ARCH. A. DAL FIUME  
LIGHTING CONCEPT FORMAT DESIGN STUDIO  
PHOTO D.DOMENICALI

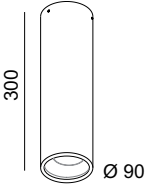

## I-PIPEDI R90 OUTDOOR









SOFFITTO - CEILING - TECHO

	W	K	lm product	lm/Led	CRI	DaliTF	∠	Dim.	H	CODE	Col.			
	LED	17	2700	1438	1790	95	15°	ø90	300	PP421.927S	01 02 12 60 99	   		
		17	2700	1438	1790	95	x 15°	ø90	300	PP421.927SD	01 02 12 60 99			
		17	2700	1530	1790	95		ø90	300	PP421.927F	01 02 12 60 99			
		17	2700	1530	1790	95	x 24°	ø90	300	PP421.927FD	01 02 12 60 99			
		17	2700	1609	1790	95		ø90	300	PP421.927W	01 02 12 60 99			
		17	2700	1609	1790	95	x 38°	ø90	300	PP421.927WD	01 02 12 60 99			
		17	3000	1546	1925	95		ø90	300	PP421.930S	01 02 12 60 99			
		17	3000	1546	1925	95	x 15°	ø90	300	PP421.930SD	01 02 12 60 99			
		17	3000	1645	1925	95		ø90	300	PP421.930F	01 02 12 60 99			
		17	3000	1645	1925	95	x 24°	ø90	300	PP421.930FD	01 02 12 60 99			
		17	3000	1730	1925	95		ø90	300	PP421.930W	01 02 12 60 99			
		17	3000	1730	1925	95	x 38°	ø90	300	PP421.930WD	01 02 12 60 99			
		OPAR16 GU10 230V	1x50						ø90	300	PP422		01 02 12 60 99	   

DimTF: Versione dimmerabile Taglio di fase / Trailing/leading edge dimmable version / Versione dimmable corte de fase.

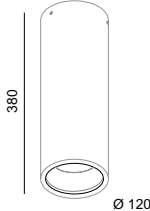
## I-PIPEDI R120 OUTDOOR

SOFFITTO - CEILING - TECHO

	W	K	lm product	lm/Led	CRI	DaliTF	∠	Dim.	H	CODE	Col.			
	LED	24,3	2700	1904	2370	95	15°	ø120	380	PP432.927S	01 02 12 60 99	   		
		24,3	2700	1904	2370	95	x 15°	ø120	380	PP432.927SD	01 02 12 60 99			
		24,3	2700	2011	2370	95		ø120	380	PP432.927F	01 02 12 60 99			
		24,3	2700	2011	2370	95	x 24°	ø120	380	PP432.927FD	01 02 12 60 99			
		24,3	2700	2095	2370	95		ø120	380	PP432.927W	01 02 12 60 99			
		24,3	2700	2095	2370	95	x 38°	ø120	380	PP432.927WD	01 02 12 60 99			
		24,3	3000	2045	2545	95		ø120	380	PP432.930S	01 02 12 60 99			
		24,3	3000	2045	2545	95	x 15°	ø120	380	PP432.930SD	01 02 12 60 99			
		24,3	3000	2160	2545	95		ø120	380	PP432.930F	01 02 12 60 99			
		24,3	3000	2160	2545	95	x 24°	ø120	380	PP432.930FD	01 02 12 60 99			
		24,3	3000	2250	2545	95		ø120	380	PP432.930W	01 02 12 60 99			
		24,3	3000	2250	2545	95	x 38°	ø120	380	PP432.930WD	01 02 12 60 99			
		OPAR16 GU10 230V	1x50						ø120	380	PP432		01 02 12 60 99	   

DimTF: Versione dimmerabile Taglio di fase / Trailing/leading edge dimmable version / Versione dimmable corte de fase.

01 - bianco - white - blanco
  02 - nero - black - negro
  12 - grigio - grey - gris
  60 - verniciato corten/painted cor-ten barnizado cor-ten
  99 - Grafite - Graphite - Grafito

## I-PIPEDI R90A MONO EMISSIONE OUTDOOR

PARETE MONO EMISSIONE - SINGLE EMISSION WALL-MOUNTED - PARED MONO EMISIÓN

LED	W	K	lm		CRI	DaliTF	∠	Dim.	H	CODE	Col.
			product	lm/Led							
	17	2700	1438	1790	95		15°	ø90	160	PP521.927S	01 02 12 60 99
	17	2700	1438	1790	95	x	15°	ø90	160	PP521.927SD	01 02 12 60 99
	17	2700	1530	1790	95		24°	ø90	160	PP521.927F	01 02 12 60 99
	17	2700	1530	1790	95	x	24°	ø90	160	PP521.927FD	01 02 12 60 99
	17	2700	1609	1790	95		38°	ø90	160	PP521.927W	01 02 12 60 99
	17	2700	1609	1790	95	x	38°	ø90	160	PP521.927WD	01 02 12 60 99
	17	3000	1546	1925	95		15°	ø90	160	PP521.930S	01 02 12 60 99
	17	3000	1546	1925	95	x	15°	ø90	160	PP521.930SD	01 02 12 60 99
	17	3000	1645	1925	95		24°	ø90	160	PP521.930F	01 02 12 60 99
	17	3000	1645	1925	95	x	24°	ø90	160	PP521.930FD	01 02 12 60 99
	17	3000	1730	1925	95		38°	ø90	160	PP521.930W	01 02 12 60 99
	17	3000	1730	1925	95	x	38°	ø90	160	PP521.930WD	01 02 12 60 99

3SDCM  
50000h L90  
B10 ta 25°C

**A+**

DimTF: Versione dimmerabile Taglio di fase / Trailing/leading edge dimmable version / Versione dimmable corte de fase.

## I-PIPEDI R90A2 BI EMISSIONE OUTDOOR

PARETE BIEMISSIONE - DOUBLE EMISSION WALL-MOUNTED - PARED BIEMISSION

LED	W	K	lm		CRI	DaliTF	∠	Dim.	H	CODE	Col.
			product	lm/Led							
	2x17	2700	2875	3580	95		15°	ø90	260	PP621.927S	01 02 12 60 99
	2x17	2700	2875	3580	95	x	15°	ø90	260	PP621.927SD	01 02 12 60 99
	2x17	2700	3059	3580	95		24°	ø90	260	PP621.927F	01 02 12 60 99
	2x17	2700	3059	3580	95	x	24°	ø90	260	PP621.927FD	01 02 12 60 99
	2x17	2700	3217	3580	95		38°	ø90	260	PP621.927W	01 02 12 60 99
	2x17	2700	3217	3580	95	x	38°	ø90	260	PP621.927WD	01 02 12 60 99
	2x17	3000	3092	3850	95		15°	ø90	260	PP621.930S	01 02 12 60 99
	2x17	3000	3092	3850	95	x	15°	ø90	260	PP621.930SD	01 02 12 60 99
	2x17	3000	3290	3850	95		24°	ø90	260	PP621.930F	01 02 12 60 99
	2x17	3000	3290	3850	95	x	24°	ø90	260	PP621.930FD	01 02 12 60 99
	2x17	3000	3460	3850	95		38°	ø90	260	PP621.930W	01 02 12 60 99
	2x17	3000	3460	3850	95	x	38°	ø90	260	PP621.930WD	01 02 12 60 99

3SDCM  
50000h L90  
B10 ta 25°C

**A+**

DimTF: Versione dimmerabile Taglio di fase / Trailing/leading edge dimmable version / Versione dimmable corte de fase.

01 - bianco - white - blanco 02 - nero - black - negro 12 - grigio - grey - gris 60 - verniciato cor-ten/painted cor-ten barnizado cor-ten 99 - Grafite - Graphite - Grafito



pag.824

OUTDOOR



## PARETE ESTERNO R120A MONO EMISSIONE OUTDOOR

PARETE MONO EMISSIONE - SINGLE EMISSION WALL-MOUNTED - PARED MONO EMISIÓN

LED	W	K	lm		CRI	∠	Dim.	H	CODE	Col.	A+
			product	lm/Led							
	24,3	2700	1904	2370	95	15°	ø120	380	PP532.927S	01 12 02 60 99	3SDCM 50000h L90 B10 ta 25°C
	24,3	2700	2011	2370	95	24°	ø120	380	PP532.927F	01 12 02 60 99	
	24,3	2700	2095	2370	95	38°	ø120	380	PP532.927W	01 12 02 60 99	
	24,3	2700	2011	2370	95	24°	ø120	380	PP532.927FDF	01 12 02 60 99	
	24,3	2700	2011	2370	95	24°	ø120	380	PP532.927FD	01 12 02 60 99	
	24,3	2700	1904	2370	95	15°	ø120	380	PP532.927SD	01 12 02 60 99	
	24,3	2700	1904	2370	95	15°	ø120	380	PP532.927SDF	01 12 02 60 99	
	24,3	2700	2095	2370	95	38°	ø120	380	PP532.927WDF	01 12 02 60 99	
	24,3	2700	2095	2370	95	38°	ø120	380	PP532.927WD	01 12 02 60 99	
	24,3	3000	2045	2545	95	15°	ø120	380	PP532.930S	01 12 02 60 99	
	24,3	3000	2160	2545	95	24°	ø120	380	PP532.930F	01 12 02 60 99	
	24,3	3000	2250	2545	95	38°	ø120	380	PP532.930W	01 12 02 60 99	
	24,3	3000	2160	2545	95	24°	ø120	380	PP532.930FD	01 12 02 60 99	
	24,3	3000	2160	2545	95	24°	ø120	380	PP532.930FDF	01 12 02 60 99	
	24,3	3000	2045	2545	95	15°	ø120	380	PP532.930SDF	01 12 02 60 99	
	24,3	3000	2045	2545	95	15°	ø120	380	PP532.930SD	01 12 02 60 99	
	24,3	3000	2250	2545	95	38°	ø120	380	PP532.930WDF	01 12 02 60 99	
	24,3	3000	2250	2545	95	38°	ø120	380	PP532.930WD	01 12 02 60 99	

DimTF: Versione dimmerabile Taglio di fase / Trailing/leading edge dimmable version / Versione dimmable corte de fase.

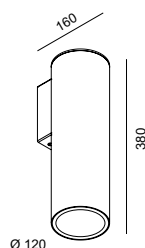

## PARETE ESTERNO R120A2 BI EMISSIONE OUTDOOR

PARETE BIEMISSIONE- DOUBLE EMISSION WALL-MOUNTED - PARED BIEMISSION

LED	W	K	lm		CRI	∠	Dim.	H	CODE	Col.	A+
			product	lm/Led							
	2x24,3	2700	3809	4740	95	15°	ø120	380	PP632.927S	01 02 12 60 99	3SDCM 50000h L90 B10 ta 25°C
	2x24,3	2700	4023	4740	95	24°	ø120	380	PP632.927F	01 02 12 60 99	
	2x24,3	2700	4190	4740	95	38°	ø120	380	PP632.927W	01 02 12 60 99	
	2x24,3	2700	4023	4740	95	24°	ø120	380	PP632.927FDF	01 02 12 60 99	
	2x24,3	2700	4023	4740	95	24°	ø120	380	PP632.927FD	01 02 12 60 99	
	2x24,3	2700	3809	4740	95	15°	ø120	380	PP632.927SD	01 02 12 60 99	
	2x24,3	2700	3809	4740	95	15°	ø120	380	PP632.927SDF	01 02 12 60 99	
	2x24,3	2700	4190	4740	95	38°	ø120	380	PP632.927WDF	01 02 12 60 99	
	2x24,3	2700	4190	4740	95	38°	ø120	380	PP632.927WD	01 02 12 60 99	
	2x24,3	3000	4090	5090	95	15°	ø120	380	PP632.930S	01 02 12 60 99	
	2x24,3	3000	4320	5090	95	24°	ø120	380	PP632.930F	01 02 12 60 99	
	2x24,3	3000	4500	5090	95	38°	ø120	380	PP632.930W	01 02 12 60 99	
	2x24,3	3000	4320	5090	95	24°	ø120	380	PP632.930FD	01 02 12 60 99	
	2x24,3	3000	4320	5090	95	24°	ø120	380	PP632.930FDF	01 02 12 60 99	
	2x24,3	3000	4090	5090	95	15°	ø120	380	PP632.930SDF	01 02 12 60 99	
	2x24,3	3000	4090	5090	95	15°	ø120	380	PP632.930SD	01 02 12 60 99	
	2x24,3	3000	4500	5090	95	38°	ø120	380	PP632.930WDF	01 02 12 60 99	
	2x24,3	3000	4500	5090	95	38°	ø120	380	PP632.930WD	01 02 12 60 99	

DimTF: Versione dimmerabile Taglio di fase / Trailing/leading edge dimmable version / Versione dimmable corte de fase.

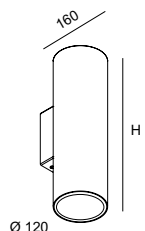

01 - bianco - white - blanco 02 - nero - black - negro 12 - grigio - grey - gris 60 - verniciato cor-ten/painted cor-ten barnizado cor-ten 99 - Grafite - Graphite - Grafito







RUOTE DA SOGNO REGGIO EMILIA - ITALY  
PROJECT ARCH. ANDREA OLIVA  
PHOTO KAI UWE SCHULTE BUNERC



---

Proiettori professionali orientabili da parete o soffitto completi di sorgenti LED professionali o per lampade LED/alogene 230V QPAR16 GU10. Completati di gruppo di alimentazione 230V/240V elettronico separato dal gruppo ottico per ottimizzazione della dissipazione del calore. Corpo e gruppo ottico in estruso di alluminio e acciaio verniciato. Snodi e braccio metallico in pressofusione di zama. Gruppo Ottico orientabile 350° sull'asse orizzontale e da 0° a -90° su quello verticale. Grado di protezione IP54.

Professional projectors for ceiling or wall installation. Complete with professional LED source or for 230V QPAR16 GU10 LED/halogen lamps. Complete with electronic 12V/230V transformer or 230V/240V control-gear box in separate housing for optimal heat dissipation. Body and optical group in painted extruded aluminium and steel. Zama die cast mechanical joints and directional metal arm. Optical group 350° horizontally and +/- 90° vertically adjustable. IP54 protection degree.

Proyectores profesionales orientables de pared o techo con LED profesionales incluidos o para lamparas LED/hàlogenas QPAR16 230V. Con grupo de alimentación 230V/240V electrónico separado del grupo óptico para optimizar la dispersión del calor. Cuerpo y grupo óptico en estruso aluminio y acero barnizado. Codo y brazo metálico en "zamak". Grupo óptico orientable 350° sobre el eje horizontal y de 0° a 90° sobre el vertical. Grado de protección IP54.

---

IN-OUT



OUTDOOR



RISTORANTE FUSION CREMA - ITALY  
PROJECT ARCH. N. BOTTONI  
PHOTO R. MONTILLO



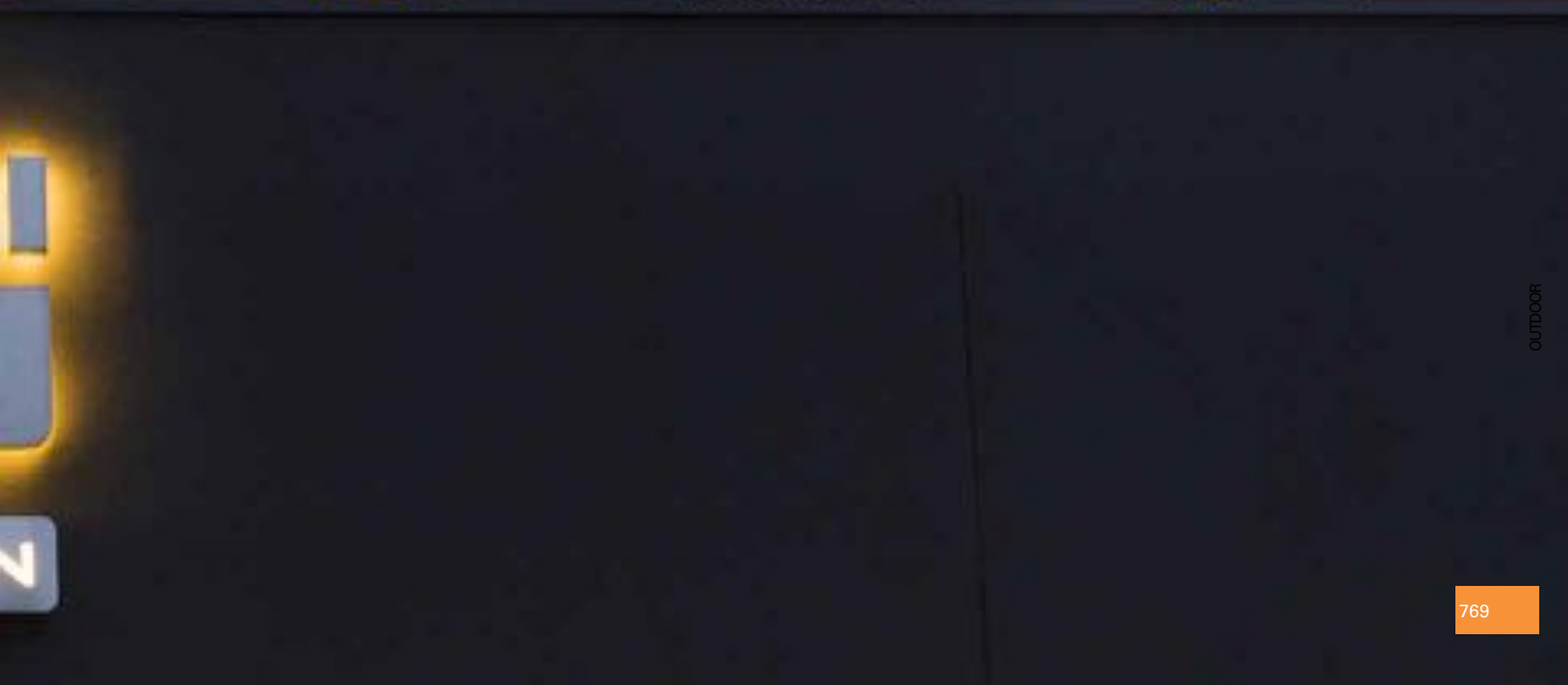

## IN-OUT 1

PROIETTORE - PROJECTOR - PROYECTOR



	W	K	lm product	lm/Led	CRI	△	CODE	Col.	
LED	11	2700	931	1100	>90	29°	LT1800.927S	01 02 60 99	
	11	2700	703	1100	>90	42°	LT1800.927F	01 02 60 99	
	11	3000	1003	1185	>90	29°	LT1800.930S	01 02 60 99	
	11	3000	757	1185	>90	42°	LT1800.930F	01 02 60 99	
3SDCM 50000h L90 B10 ta 25°C	11	4000	1088	1285	>90	29°	LT1800.940S	01 02 60 99	
<b>A+</b>	11	4000	821	1285	>90	42°	LT1800.940F	01 02 60 99	

in caso di utilizzo di lampade LED utilizzare lampade di potenza 10W o superiore, adatte all'utilizzo con trasformatori elettronici in corrente alternata 230Vac/12Vac. Per alcuni modelli è necessari verificare anche la compatibilità dimensionale tra lampade e apparecchio. | in case of using LED lamps MR16 GU5,3, use 10W power lamps or more, suitable for use with electronic transformers in AC 230Vac/12Vac. Some models also need to verify the dimensional compatibility between equipment and lamps. | en el caso de lámparas LED MR16 GU5,3 utilizar lámparas de 10W o más, que pueda funcionar con transformadores electrónicos en AC 230Vac/12Vac. Algunos modelos también tienen que verificar la compatibilidad dimensional entre los equipos y lámparas.

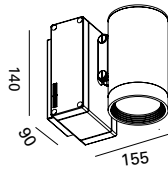

## IN-OUT 230

PROIETTORE - PROJECTOR - PROYECTOR



	W	CODE	Col.	
QPAR16 GU10 230V	1x max 50	LT1809	01 02 60 99	
<b>A++-D</b>				

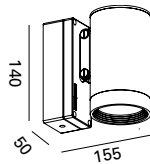







## FILE 2 OUTDOOR

Apparecchio da soffitto ed incasso per illuminazione diretta diffusa, per sorgenti lineari LED. Alimentazione elettronica integrata alimentata a 350mA. Corpo in estruso di alluminio 75x78 mm. Finitura verniciata o anodizzata. Cornice di battuta super-slim larghezza 5 mm. Completi di staffe di fissaggio al controsoffitto con sistema di regolazione a vite e testate di chiusura laterali e schermo diffondente in policarbonato opalino bianco. Grado di protezione IP54.

Wall fan recessed fixtures for direct diffused lighting. For integrated linear LED sources. Integrated electronic supply fed at 350mA. Body in 75x78 mm. extruded aluminium. Painted or anodized finish. Super-slim 5 mm. width edge trim. Complete with false-ceiling/wall fixing brackets, provided with micro-regulation screw system, side end caps and opal white. Protection degree IP54.

Aparato techo y empotrable para iluminación directa difuminada, para LED. Alimentación electrónica integrada a 350mA. Cuerpo en estruso de aluminio 75x78mm. Acabado barnizado o anodizado. Marco "super-slim" de sólo 5mm. Con soporte de fijación al falso techo con sistema de regulación mediante tornillo y tapas de cierre laterales y difusor en policarbonato opal blanco. Grado de protección IP54.

# FILE 2 INCASSO LED IP54 CON DIFFUSORE OPALINO

IP54 RECESSED WITH OPAL DIFFUSER- EMPOTRADO CON DIFUSOR OPAL

80xL+2



	W	K	lm product	lm/Led	CRI	DalIT&D	Lmm	Kg	CODE	Col.
LINEAR LED 24W/MT 2200LM/MT CRI=80	19,2	3000	1104	1848	>80		860	2.50	LTC730IP	01 02 27
	19,2	3000	1104	1848	>80	x	860	2.80	LTC730IPD	01 02 27
	25,6	3000	1472	2464	>80		1140	3.30	LTC731IP	01 02 27
	25,6	3000	1472	2464	>80	x	1140	3.80	LTC731IPD	01 02 27
	32	3000	1840	3080	>80		1420	4.00	LTC732IP	01 02 27
	32	3000	1840	3080	>80	x	1420	4.50	LTC732IPD	01 02 27
	38,4	3000	2208	3696	>80		1700	4.70	LTC733IP	01 02 27
	38,4	3000	2208	3696	>80	x	1700	5.25	LTC733IPD	01 02 27
	44,8	3000	2576	4312	>80		1985	5.50	LTC734IP	01 02 27
	44,8	3000	2576	4312	>80	x	1985	5.90	LTC734IPD	01 02 27
	51,2	3000	2944	4928	>80		2265	6.00	LTC735IP	01 02 27
	51,2	3000	2944	4928	>80	x	2265	6.40	LTC735IPD	01 02 27
	57,6	3000	3313	5544	>80		2545	6.40	LTC736IP	01 02 27
	57,6	3000	3313	5544	>80	x	2545	6.80	LTC736IPD	01 02 27
	64	3000	3681	6160	>80		2825	6.90	LTC737IP	01 02 27
	64	3000	3681	6160	>80	x	2825	7.40	LTC737IPD	01 02 27

50000h Ta 25°  
L70B10

A+



	W	K	lm product	lm/Led	CRI	DalIT&D	Lmm	Kg	CODE	Col.
LINEAR LED 41W/MT 4640LM/MT CRI90	34,2	3000	1910	3900	90		860	2.50	LTC730AIP	01 02 27
	34,2	3000	1910	3900	90	x	860	2.80	LTC730AIPD	01 02 27
	45,6	3000	2547	5200	90		1140	3.30	LTC731AIP	01 02 27
	45,6	3000	2547	5200	90	x	1140	3.80	LTC731AIPD	01 02 27
	57	3000	3184	6500	90		1420	4.00	LTC732AIP	01 02 27
	57	3000	3184	6500	90	x	1420	4.50	LTC732AIPD	01 02 27
	68,4	3000	3820	7800	90		1700	4.70	LTC733AIP	01 02 27
	68,4	3000	3820	7800	90	x	1700	5.25	LTC733AIPD	01 02 27
	79,8	3000	4457	9100	90		1985	5.50	LTC734AIP	01 02 27
	79,8	3000	4457	9100	90	x	1985	5.90	LTC734AIPD	01 02 27
	91,2	3000	5094	10400	90		2265	6.00	LTC735AIP	01 02 27
	91,2	3000	5094	10400	90	x	2265	6.40	LTC735AIPD	01 02 27
	102,6	3000	5731	11700	90		2545	6.40	LTC736AIP	01 02 27
	102,6	3000	5731	11700	90	x	2545	6.80	LTC736AIPD	01 02 27
	114	3000	6367	13000	90		2825	6.90	LTC737AIP	01 02 27
	114	3000	6367	13000	90	x	2825	7.40	LTC737AIPD	01 02 27

A+



Su richiesta disponibile la versione 4000K | On request available 4000K version | Versión con 4000K a demanda.

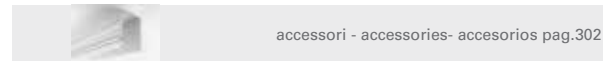
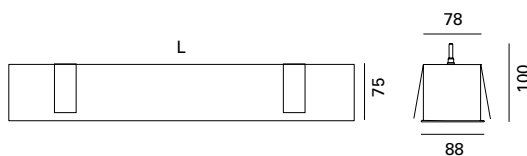

accessori - accessories- accesorios pag.302

01 - bianco - white - bianco    02 - nero - black - negro    27 - ossidato alluminio - oxidised aluminium - oxidado aluminio

pag.824

OUTDOOR

# FILE 2 SOFFITTO IP54 CON DIFFUSORE OPALINO

CEILING WITH OPALINE DIFFUSER- TECHO CON DIFUSOR OPALINO

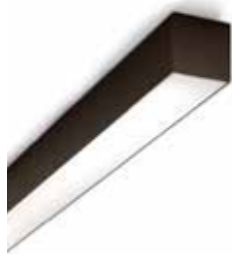

	W	K	lm product	lm/Led	CRI	DalIT&D	Lmm	CODE	Col.
LINEAR LED 24W/MT 2200LM/MT CRI>80	19,2	3000	1104	1848	>80		860	LTC530IP	01 02 27 49
	19,2	3000	1104	1848	>80	x	860	LTC530IPD	01 02 27 49
	25,6	3000	1472	2464	>80		1140	LTC531IP	01 02 27 49
	25,6	3000	1472	2464	>80	x	1140	LTC531IPD	01 02 27 49
	32	3000	1840	3080	>80		1420	LTC532IP	01 02 27 49
	32	3000	1840	3080	>80	x	1420	LTC532IPD	01 02 27 49
	38,4	3000	2208	3696	>80		1700	LTC533IP	01 02 27 49
	38,4	3000	2208	3696	>80	x	1700	LTC533IPD	01 02 27 49
	44,8	3000	2576	4312	>80		1985	LTC534IP	01 02 27 49
	44,8	3000	2576	4312	>80	x	1985	LTC534IPD	01 02 27 49
	51,2	3000	2944	4928	>80		2265	LTC535IP	01 02 27 49
	51,2	3000	2944	4928	>80	x	2265	LTC535IPD	01 02 27 49
	57,6	3000	3313	5544	>80		2545	LTC536IP	01 02 27 49
	57,6	3000	3313	5544	>80	x	2545	LTC536IPD	01 02 27 49
	64	3000	3681	6160	>80		2825	LTC537IP	01 02 27 49
	64	3000	3681	6160	>80	x	2825	LTC537IPD	01 02 27 49
50000h Ta 25° L70B10									



	W	K	lm product	lm/Led	CRI	DalIT&D	Lmm	CODE	Col.
LINEAR LED 41W/MT 4640LM/MT CRI90	34,2	3000	1910	3900	90		860	LTC530AIP	01 02 27 49
	34,2	3000	1910	3900	90	x	860	LTC530AIPD	01 02 27 49
	45,6	3000	2547	5200	90		1140	LTC531AIP	01 02 27 49
	45,6	3000	2547	5200	90	x	1140	LTC531AIPD	01 02 27 49
	57	3000	3184	6500	90		1420	LTC532AIP	01 02 27 49
	57	3000	3184	6500	90	x	1420	LTC532AIPD	01 02 27 49
	68,4	3000	3820	7800	90		1700	LTC533AIP	01 02 27 49
	68,4	3000	3820	7800	90	x	1700	LTC533AIPD	01 02 27 49
	79,8	3000	4457	9100	90		1985	LTC534AIP	01 02 27 49
	79,8	3000	4457	9100	90	x	1985	LTC534AIPD	01 02 27 49
	91,2	3000	5094	10400	90		2265	LTC535AIP	01 02 27 49
	91,2	3000	5094	10400	90	x	2265	LTC535AIPD	01 02 27 49
	102,6	3000	5731	11700	90		2545	LTC536AIP	01 02 27 49
	102,6	3000	5731	11700	90	x	2545	LTC536AIPD	01 02 27 49
	114	3000	6367	13000	90		2825	LTC537AIP	01 02 27 49
	114	3000	6367	13000	90	x	2825	LTC537AIPD	01 02 27 49



Su richiesta disponibile la versione 4000K | On request available 4000K version | Versión con 4000K a demanda.



accessori - accessories - accesorios pag.302

01 - bianco - white - bianco    02 - nero - black - negro    27 - ossidato alluminio - oxidised aluminium - oxidado aluminio

49 - moka

pag.824



CASCIOLI - BMW SAN BENEDETTO DEL TRONTO - ITALY  
PHOTO ER STUDIO

Apparecchi da incasso calpestabili a scomparsa totale trimless, per illuminazione diretta diffusa. Sorgenti lineari LED resinate da completare con alimentatore remoto 24Vdc. Disponibili come moduli finiti o come moduli da assemblare a sistema. Corpo in estruso di alluminio, finitura anodizzata. Testate di chiusura laterali con sistema Light Proof. Grado di protezione IP67.

Walk-over trimless-recessed fittings for direct diffused lighting emission. Resined linear LED sources, to be completed with remote 24Vdc driver. Available both as default modules and as modules to be assembled in a system. Body in extruded aluminium, anodized finish. Light Proof system side-end caps. Degree of protection IP67.

Serie de aparatos a empotrar walk-over sin marco (totalmente empotrado "trimless" para iluminación difuminada. Fuente de luz lineal LED resinada a completar con alimentador remoto 24Vdc. Disponibles como aparatos completos o como módulos para ensamblar (sistema). Cuerpo en estruso de aluminio, acabado anodizado. Tapas de cierre laterales con sistema "Light Proof". Grado de protección IP67.

---



**MICROFILE OUTDOOR**

OUTDOOR

# MICROFILE LED INCASSO RASATO CALPESTABILE IP65 19W/MT

WALK-OVER TRIMLESS RECESSED - TOTAL EMPOTRADO WALK-OVER



	W	K	lm product	lm/Led	CRI
linear LED	9,6	3000	485	840	>80
	19	3000	970	1680	>80

19W/mt  
240 LED/mt  
1680lm/mt

A+

Da completare con cassaforma - To be completed with wallbox - A completar con caja

A	L.mm	Kg	CODE	Col.
V.1	510	0.40	MF06.1	27
V.1	1010	0.56	MF06.2	27

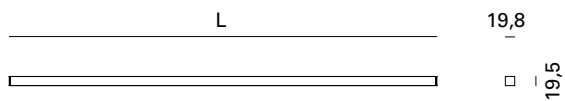
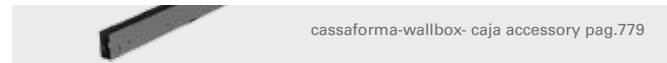



## CASSAFORMA IN ACCIAIO INOSSIDABILE AISI 304

AISI 304 STAINLESS STEEL WALLBOX - CAJA EN ACERO AISI 304 TOTAL EMPOTRADO



Lmm	Kg	CODE
510	0,28	<b>MF06.C1</b>
1010	0,60	<b>MF06.C2</b>

## GIUNTI D'UNIONE PER CASSAFORMA

LINEAR JOINT FOR WALLBOX - LINEAL JUNTO POR LA CAJA



CODE
<b>MF06.CG</b>



iperco

CENTRO COMMERCIALE CONE CONEGLIANO VENETO - ITALY  
PROJECT ARCH. K.MAGGI - DIFFUSIONE LUCE  
PHOTO M. FLORES





Proiettori da incasso a terra calpestabile o carrabile, fisso od orientabile, per illuminazione di superfici verticali o per illuminazione radente di orientamento e guida . Completo di sorgente LED 1,5W alimentabile a 500mA o predisposto per lampade QR-CB35 12V/230V alogene max. 20W o LED. Alimentazione inclusa nel corpo dell'apparecchio o remota disponibile come accessorio. Corpo in pressofusione di alluminio e particolari in acciaio inox. Versioni orientabili: gruppo ottico orientabile di 25° sull'asse orizzontale e 355° su quello verticale. Da cablare con cavo in neoprene. Cassaforma in lamiera di alluminio per incasso in laterizio o calcestruzzo disponibile come accessorio. Grado di protezione IP67.

Series of inground or wall recessed professional, adjustable or fix, projectors for lighting vertical surfaces or for directional and guidance lighting. Integrated with professional 1,5W LED (depending on whether fed at 500mA) or for 12V/230V QR-CB 35 LED or max. 20W halogen lamps. Power supply included in the fixture's body or remote available as an accessory. Fixture's body in die cast aluminium, mechanical details in stainless steel. Adjustable versions: optical group 25° horizontally and 355° vertically adjustable. To be wired with neoprene cables. Anodized aluminium wallbox for recessed installation in concrete or brick walls, available as an accessory. IP67 protection degree.

Proyectores para empotrar en el suelo transitable, fijo u orientable, para iluminación de superficies verticales o para iluminación de orientación y guía. Con LED 1,5W alimentable a 500mA, o preparado para lámparas QR-CB35 12V/230V halógenas max. 20W o LED. Alimentación situada en el cuerpo del aparato o remota disponible como accesorio. Cuerpo en presofusión de aluminio y detalles en acero inox. Versiones orientables: grpo óptico orientable 25° sobre el eje horizontal y 355° sobre el vertical. A cablear con cable en neopreno. Caja en lamina de aluminio para empotrar en ladrillo u hormigón, disponible como accesorio. Grado de protección IP67.

**FORMAT**



OUTDOOR

## FORMAT LED 34F CALPESTABILE

WALK-OVER RECESSED - EMPOTRADO WALK-OVER

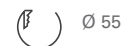

LED	W	mA	K	lm product	lm/Led	CRI	△	A	Dim.	H	CODE	Col.	
50000h L70 B10 ta 25°C <b>A+</b>	1,5	500	3000	252	350	>80	16°	5.1	∅70	48	LT3460A	12 20	
	1,5	500	3000	136	189	>80	30°	5.1	∅70	48	LT3460B	12 20	

ATTENZIONE: cablare con cavo in neoprene | WARNING: wiring with neoprene cable | ATENCIÓN: instalaci3n electrica con cable en neoprene.  
Da completare con cassaforma - To be completed with wallbox - A completar con caja



accessori - accessories - accesorios pag.786

## FORMAT LED 35F CALPESTABILE

WALK-OVER RECESSED - EMPOTRADO WALK-OVER

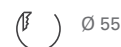

LED	W	mA	K	lm product	lm/Led	CRI	△	A	Dim.	H	CODE	Col.	
50000h L70 B10 ta 25°C <b>A+</b>	1,5	500	3000	252	350	>80	16°	5.1	70x70	48	LT3461A	12 20	
	1,5	500	3000	136	189	>80	30°	5.1	70x70	48	LT3461B	12 20	

ATTENZIONE: cablare con cavo in neoprene | WARNING: wiring with neoprene cable | ATENCIÓN: instalaci3n electrica con cable en neoprene.  
Da completare con cassaforma - To be completed with wallbox - A completar con caja

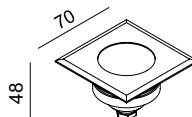

accessori - accessories - accesorios pag.786

## FORMAT LED 4 ORIENTABILE

DIRECTIONAL RECESSED - EMPOTRABLE AJUSTABLE

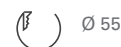

LED	W	mA	K	lm product	lm/Led	CRI	△	A	Dim.	H	CODE	Col.	
50000h L70 B10 ta 25°C <b>A+</b>	1,5	500	3000	252	350	>80	16°	5.1	∅70	63	LT3410A	12 20	
	1,5	500	3000	136	189	>80	30°	5.1	∅70	63	LT3410B	12 20	

ATTENZIONE: cablare con cavo in neoprene | WARNING: wiring with neoprene cable | ATENCIÓN: instalaci3n electrica con cable en neoprene.  
Da completare con cassaforma - To be completed with wallbox - A completar con caja

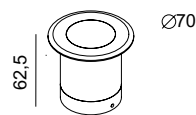

accessori - accessories - accesorios pag.786

12 - grigio - grey - gris

20 - acciaio satinato - brushed steel - acero satinado



pag.824



pag.820



## FORMAT LED 10 ORIENTABILE E CALPESTABILE

DIRECTIONAL AND WALK-OVER RECESSED - EMPOTRADO AJUSTABLE Y WALK-OVER

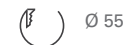

LED	W	mA	K	lm product	lm/Led	CRI	△	A	Dim.	H	CODE	Col.	
50000h L70 B10 ta 25°C	1,5	500	3000	252	350	>80	16°	5.1	70x70	63	LT3412A	12 20	CE IP67
A+	1,5	500	3000	136	189	>80	30°	5.1	70x70	63	LT3412B	12 20	IP67 LED

ATTENZIONE: cablare con cavo in neoprene | WARNING: wiring with neoprene cable | ATENCIÓN: instalación eléctrica con cable en neoprene  
Da completare con cassaforma - To be completed with wallbox - A completar con caja

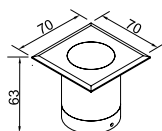

accessori - accessories - accesorios pag.786

## FORMAT LED 12FT

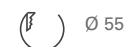

QR-CB35 GU4 12V	W	A	Dim.	H	CODE	Col.	
A+-D	1x max 35 L max 40mm	T.1	ø70	96	LT3470	03 12 20	IP67 LED

ATTENZIONE: la superficie raggiunge alte temperature | WARNING: the surface reach high temperature | ATENCIÓN: la temperatura superficial alcanza alta.  
Da completare con cassaforma - To be completed with wallbox - A completar con caja

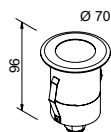

accessori - accessories - accesorios pag.786

## FORMAT LED 12FQ



QR-CB35 GU4 12V	W	A	Dim.	H	CODE	Col.	
A+-D	1x max 35 L max 40mm	T.1	70x70	96	LT3471	03 12 20	IP67 LED

ATTENZIONE: la superficie raggiunge alte temperature | WARNING: the surface reach high temperature | ATENCIÓN: la temperatura superficial alcanza alta.  
Da completare con cassaforma - To be completed with wallbox - A completar con caja

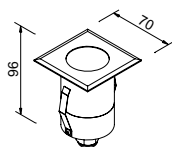

accessori - accessories - accesorios pag.786

03 - cromo - chrome - cromo

12 - grigio - grey - gris

20 - acciaio satinato - brushed steel - acero satinado

pag.824

A pag.820

OUTDOOR



## CASSAFORMA PER FORMAT 34-35

WALLBOX FOR FORMAT 34-35 - CAJA PARA FORMAT 34-35

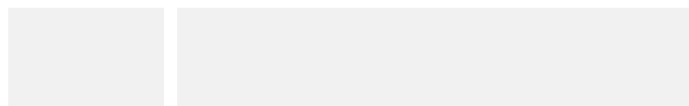
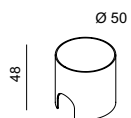

Dim.	H
$\varnothing 63$	100

CODE
LT3460.CC



## CASSAFORMA PER FORMAT 4-10-12FT--12FQ

WALLBOX FOR FORMAT 4-10-12F - 12FQ CAJA PARA FORMAT 4-10-12F - 12FQ

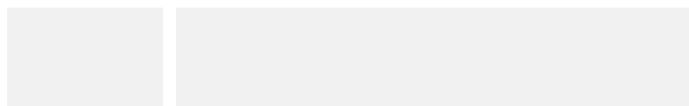
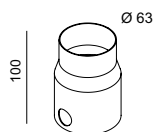

Dim.	H
$\varnothing 63$	100

CODE
LT3410.CC





---

Apparecchio da incasso a parete per illuminazione segnapasso direzionata con angolo di 20°, per sorgente LED integrata con alimentazione remota disponibile come accessorio. Corpo e cornice di battuta super-slim larghezza 5 mm. in metallo verniciato. Installabile anche in pareti e soffitti in calcestruzzo mediante apposita cassaforma in lamiera zincata disponibile come accessorio. Grado di protezione IP65.

Recessed downlight for wall installation, for guidance lighting with 20° angle direction, for integrated LED source with remote power-supply available as an accessory. Body and super-slim 5 mm width frame in painted metal. It can also be installed in concrete or brick walls through specific galvanized steel wall-box, available as an accessory. Degree of protection IP65.

Lampara emportable por la pared y con angulo marcador direccional de 20°, LED integrado con reactancia remota disponible como accesorio. Cuerpo y marco super-slim 5mm de ancho. In metal pintado. Tambien puede ser instalado en paredes y techos de hormigon usando una caja en lamina de zinc, disponible como accesorio. Grado de proteccion IP65.

---

**STEP**



OUTDOOR





OUTDOOR

**STEP 75 OUTDOOR**

27X69

INCASSO - RECESSED - EMPOTRADO



LED

50000h L70  
B10 ta 25°C

A+

Da completare con cassaforma - To be completed with wallbox - A completar con caja



W	mA	K	lm product	lm/Led	CRI	△
1,5	500	3000	252	350	>80	16

A

5.1

Kg

0,2

CODE

LT1983BCIP 01 02

Col.

IP65

CE



accessori - accessories- accesorios pag.793

**STEP 150 OUTDOOR**

27X144

INCASSO - RECESSED - EMPOTRADO



LED

50000h L70  
B10 ta 25°C

A+

Da completare con cassaforma - To be completed with wallbox - A completar con caja

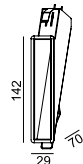

W	mA	K	lm product	lm/Led	CRI	△
1,5	500	3000	252	350	>80	16

A

5.1

Kg

0,4

CODE

LT1983BCIP 01 02

Col.

IP65

CE



accessori - accessories- accesorios pag.793

**STEP 300 OUTDOOR**

27X372

INCASSO - RECESSED - EMPOTRADO



LED

50000h L70  
B10 ta 25°C

A+

Da completare con cassaforma - To be completed with wallbox - A completar con caja

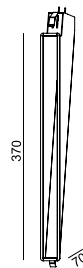

W	mA	K	lm product	lm/Led	CRI	△
1,5	500	3000	252	350	>80	16°

A

5.1

Kg

0,7

CODE

LT1981BCIP 01 02

Col.

IP65

CE



accessori - accessories- accesorios pag.793

01 - bianco - white - blanco    02 - nero - black - negro

pag.824

A pag.820



## CASSAFORMA PER STEP 75

WALLBOX FOR STEP 75- CAJA PARA STEP 75

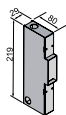

Dim. H  
30x80 220

CODE  
LT1992



## CASSAFORMA PER STEP 150

WALLBOX FOR STEP 150- CAJA PARA STEP 150

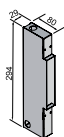

Dim. H  
30x80 265

CODE  
LT1991



## CASSAFORMA PER STEP 300

WALLBOX FOR STEP 300- CAJA PARA STEP 300

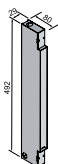

Dim. H  
30x80 495

CODE  
LT1990



Apparecchi da pavimento per illuminazione di orientamento e guida, ad emissione monolaterale, completi di sorgenti LED alimentati a 700mA. Corpo in metallo finitura verniciata. Gruppo ottico in alluminio completo di lente ad emissione asimmetrica e vetro di protezione temperato. Alimentazione elettronica 50/60 Hz 230/240V inclusa nel corpo dell'apparecchio. Piastra di montaggio in acciaio per il fissaggio a terra. Disponibile in tre altezze da 20 cm., 40 cm. e da 80 cm. Grado di protezione IP65.

Floor fixture for directional and guidance lighting. Complete with professional LED source fed at 700mA. Fixture's body in painted metal. Optical group complete with asymmetrical mission lens and tempered protection glass. Provided with steel mounting plate for the fixture's installation onto ground. Available in 200mm., 400mm. and 800mm. heights. Degree of protection IP65.

Aparatos de pavimento para iluminación de orientación y guía, de emisión monolateral, con LED alimentados a 700mA. Cuerpo en metal acabado barnizado. Grupo óptico en aluminio con lente de emisión asimétrica y cristal de protección templado. Alimentación electrónica 50/60 Hz 230/240V situada en el cuerpo del aparato. Soporte de montaje en acero para la fijación en el suelo. Disponible en tres medidas de altura de 20 cm., 40 cm. y 80 cm. Grado de protección IP65.

**PIEDINI**



OUTDOOR



VILLA PRIVATA







## PIEDINI 200



LED  
50000h L70  
B10 ta 25°C

A+

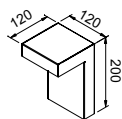

W	K	lm product	lm/Led	CRI
3	3000	177	270	80
3	4000	190	290	80

H  
200  
200

CODE  
LT7500  
LT7501

Col.  
01 60 99  
01 60 99



## PIEDINI 400



LED  
50000h L70  
B10 ta 25°C

A+

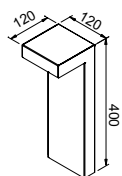

W	K	lm product	lm/Led	CRI
3	3000	177	270	80
3	4000	190	290	80

H  
400  
400

CODE  
LT7502  
LT7503

Col.  
01 60 99  
01 60 99



## PIEDINI 800



LED  
50000h L70  
B10 ta 25°C

A+

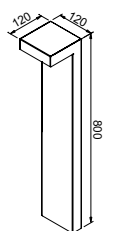

W	K	lm product	lm/Led	CRI
3	3000	177	270	80
3	4000	190	290	80
6	3000	354	540	80
6	4000	380	580	80

H  
800  
800  
800  
800

CODE  
LT7504  
LT7505  
LT7506  
LT7507

Col.  
01 60 99  
01 60 99  
01 60 99  
01 60 99



01 - bianco - white - blanco

60 - verniciato corten - painted corten - barnizado corten

99 - Grafite - Graphite - Grafito

pag.824

OUTDOOR



## VINTAGE RANGE

ATLAS p.802



ORION p.804



FLOW p.808



MIMOS p.812



PLANET p.814



HARIO p.816





---

ATLAS



Collezione di lampade da parete o soffitto ad un arco, disponibile in tre dimensioni. Struttura in metallo verniciata bianca e diffusore in tessuto elasticizzato bianco lavabile.

Wall or ceiling lamp with one arch, diffused light, available in three dimensions. Body in white painted metal. Diffuser washable in white elasticized fabric.

Colección de lámparas de pared o techo de uno arco, disponible en tres medidas. Estructura en metal barnizado blanco y difusor en tela elástica blanca lavable.

---

# ATLAS PARETE/SOFFITTO

CEILING/WALL- TECHO/PARED



	W	Dim.	CODE	
QA60/QT32/TC-TSE E27 230V	2x max 60	500x500	AT132/50	
E27 230V	2x max 75 2x max 100	600x600 800x800	AT132/60 AT132/80	

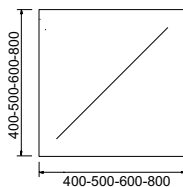

# TESSUTO DI RICAMBIO



	Dim.	CODE
	400x400 500x500 600x600 800x800	TES40 TES50 TES60 TES80

Collezione di lampade da parete/soffitto per interni a luce di proiezione orientabile. Corpi, bracci, snodo pluridirezionale in ottone. Finiture con trattamento galvanico o ottone naturale non verniciato. Cablaggi per lampade alogene 230V tensione di rete 12V o bassissima tensione.

Collection of wall/ceiling indoor adjustable lamp. Body, arms, adjustable joint are made of brass. Natural or galvanized finishing. Halogen 12V low voltage wiring or 230V main voltage.

Colección de lámparas de pared/techo de interior con luz de proyección orientable. Cuerpos, brazos y codos pluri direccionales en latón. Acabado galvanizado o latón no barnizado. Cableados para lámparas halógenas 230V tensión de red o 12V a bajísima tensión.

---

ORION



## ORION 1



QPAR16 GU10 230V W  
1x Led/Halo max 50

CODE Col.  
**OR11** **03 06 08 17**



Attenzione non utilizzare lampadine di altezza superiore a 60 mm | warning do not use lamps over 60 mm lenght | Atención no utilice lámparas de altura superior a 60 mm.

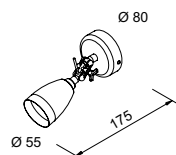

## ORION 2



QPAR16 GU10 230V W  
2x Led/Halo max 50

CODE Col.  
**OR12** **03 06 08 17**



Attenzione non utilizzare lampadine di altezza superiore a 60 mm | warning do not use lamps over 60 mm lenght | Atención no utilice lámparas de altura superior a 60 mm.

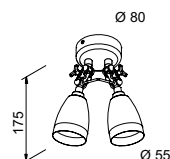

## ORION F1



QPAR16 GU10 230V W  
1x Led/Halo max 50  
1x Led/Halo max 50

Lmm  
510  
610

CODE Col.  
**OR141** **03 06 08 17**  
**OR151** **03 06 08 17**



Attenzione non utilizzare lampadine di altezza superiore a 60 mm | warning do not use lamps over 60 mm lenght | Atención no utilice lámparas de altura superior a 60 mm.

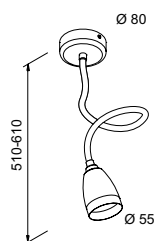

03 - cromo - chrome - cromo    06 - nichel satinato - brushed nichel - nichel satinado    08 - ottone brunito - burnished brass - laton pulido    17 - ottone naturale - natural brass - laton natural



## ORION F2



 	W	Lmm	CODE	Col.	
	QPAR16 GU10 230V 2x Led/Halo max 50 2x Led/Halo max 50	510 610	OR142 OR152	03 06 08 17 03 06 08 17	

Attenzione non utilizzare lampadine di altezza superiore a 60 mm | warning do not use lamps over 60 mm length | Atención no utilice lámparas de altura superior a 60 mm.

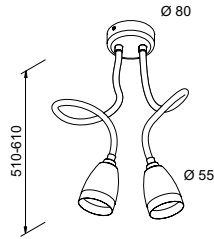

## ORION ARC



 	W	Lmm	CODE	Col.	
	QPAR16 GU10 230V 1x Led/Halo max 50		OR16	03 06 08 17	

Attenzione non utilizzare lampadine di altezza superiore a 60 mm | warning do not use lamps over 60 mm length | Atención no utilice lámparas de altura superior a 60 mm.

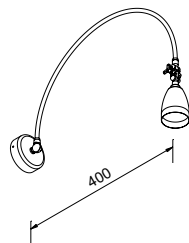

## FLOW

Apparecchi da parete orientabili per lampade prefocalizzate LED o alogene QR-LP 111 e QR-CB 51 12V/230V. Completi di trasformatore 12V/230V elettronici inclusi nella base di fissaggio. Base, asta e gruppo ottico in metallo finitura cromata o nickel satinato. Snodi di rotazione e particolari meccanici in acciaio finitura cromata. Orientabilità 350° sull'asse orizzontale e +/- 170° su quello verticale.



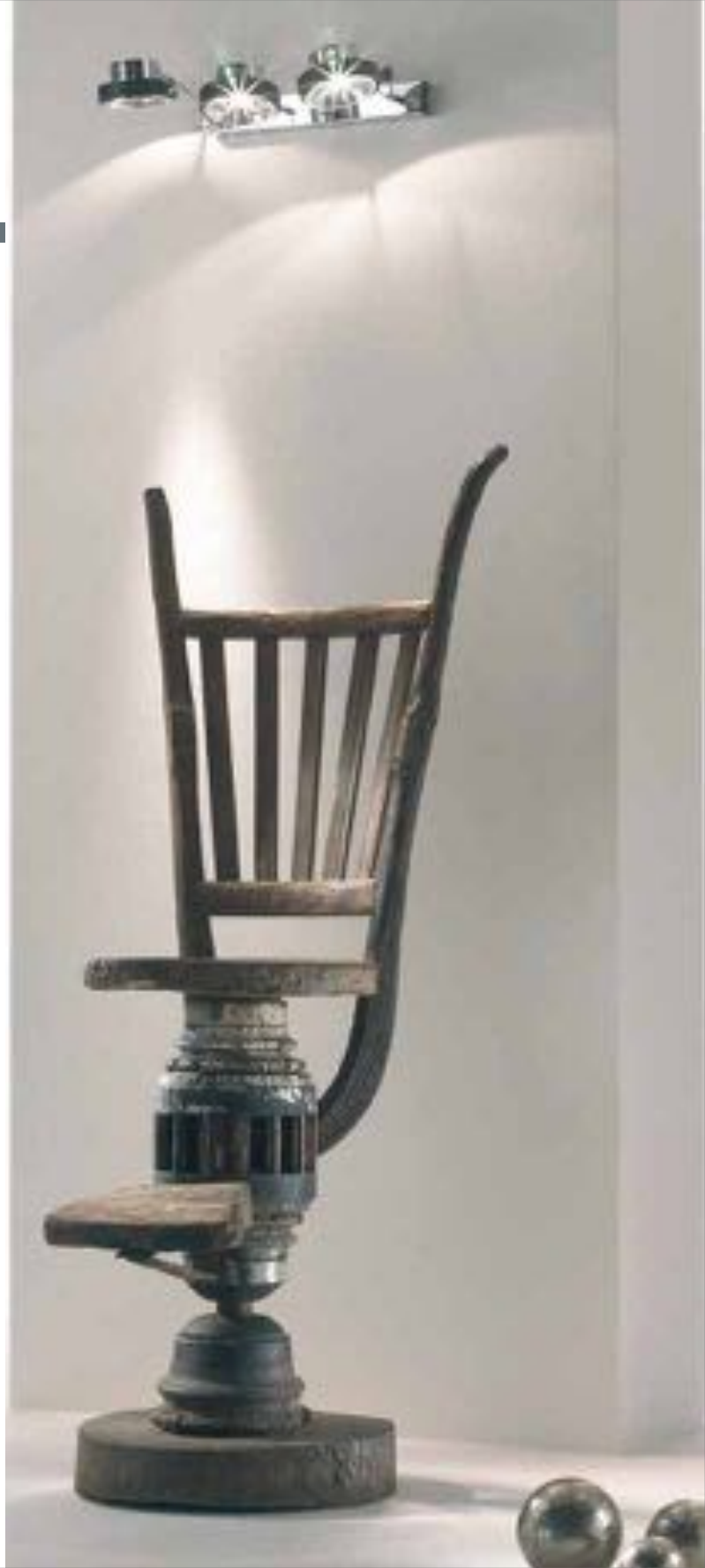

Wall-mounted fixtures for prefocused LED or halogen QR-LP 111 and QR-CB 51 12V/230V lamps. Complete with electronic transformer 12V/230V included in the fixing base. Base, rod and optic unit in metal with chrome or brushed nickel finish. Rotational joints and mechanical elements in steel with chrome finish. Adjustable 350 ° on the horizontal axis and + / - 170 ° on the vertical one.

Aparatos de iluminación de pared para lamparas prefocalizzate LED o halógena QR-LP 111 y QR-CB 12V/230V 51. Completo con transformador electrónico 12V/230V incluidos en la base de montaje. Base, caña y metal cromado o níquel cepillado óptico. Articulaciones rotacionales y acabado mecánico de acero cromado. Ajustable de 350 ° horizontal y + / - 170 ° en vertical.



## FLOW



	W	Dim.TF	A	CODE	Col.	
QR-LP 111 G53 12V  	1x Led/Halo max 60	x	<b>T.2</b>	<b>FW02</b>	<b>03 06</b>	  



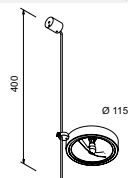

Il peso massimo consentito delle lampade LED QR-LP 111 sui nostri proiettori è di 275 g | The maximum allowed weight of 12V QR-LP 111 LED lamps is of 275 gr | El peso máximo admisible de las lámparas LED QR-LP 111 para nuestros proyectores es de 275gr



DimTF: Versione dimmerabile Taglio di fase / Trailing/leading edge dimmable version / Versione dimmable corte de fase.

## FLOW 01



	W	Dim.TF		CODE	Col.	
QR-LP 111 G53 12V  	1x Led/Halo max 60	x		<b>FW04</b>	<b>03 06</b>	  



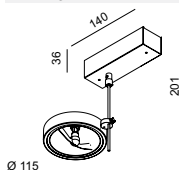

I trasformatori 230Vac/12Vac presentati in questo catalogo sono testati con i principali produttori di lampade LED. A causa della velocità dell'adeguamento tecnologico di queste ultime, Lucifero's non può garantire una compatibilità universale delle stesse con i propri trasformatori. Il peso massimo consentito delle lampade LED QR-LP 111 sui nostri proiettori è di 275 g. | The 230Vac/12Vac transformers presented on this catalogue have been tested with the leading LED lamps manufacturers. Due to the pace of the technological update of them, Lucifero's cannot guarantee their universal compatibility with its transformers. The maximum allowed weight of 12V QR-LP 111 LED lamps is of 275 gr | Los transformadores 230Vac/12Vac presentados en este catálogo han sido testados con los principales productores de lámparas LED. Debido a la rápida evolución tecnológica de estas, Lucifero's no puede garantizar una compatibilidad universal de las mismas con nuestros transformadores. El peso máximo admisible de las lámparas LED QR-LP 111 para nuestros proyectores es de 275gr.



DimTF: Versione dimmerabile Taglio di fase / Trailing/leading edge dimmable version / Versione dimmable corte de fase.

## FLOW 02



	W	Dim.TF		CODE	Col.	
QR-LP 111 G53 12V  	2x Led/Halo max 50	x		<b>FW06</b>	<b>03 06</b>	  

I trasformatori 230Vac/12Vac presentati in questo catalogo sono testati con i principali produttori di lampade LED. A causa della velocità dell'adeguamento tecnologico di queste ultime, Lucifero's non può garantire una compatibilità universale delle stesse con i propri trasformatori. Il peso massimo consentito delle lampade LED QR-LP 111 sui nostri proiettori è di 275 g. | The 230Vac/12Vac transformers presented on this catalogue have been tested with the leading LED lamps manufacturers. Due to the pace of the technological update of them, Lucifero's cannot guarantee their universal compatibility with its transformers. The maximum allowed weight of 12V QR-LP 111 LED lamps is of 275 gr | Los transformadores 230Vac/12Vac presentados en este catálogo han sido testados con los principales productores de lámparas LED. Debido a la rápida evolución tecnológica de estas, Lucifero's no puede garantizar una compatibilidad universal de las mismas con nuestros transformadores. El peso máximo admisible de las lámparas LED QR-LP 111 para nuestros proyectores es de 275gr.

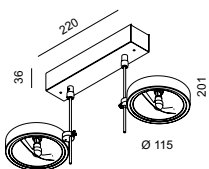

DimTF: Versione dimmerabile Taglio di fase / Trailing/leading edge dimmable version / Versione dimmable corte de fase.

## FLOW 03



QR-LP 111 G53 12V	W	Dim.TF	CODE	Col.	
	3 x Led/Halo max 50	x	<b>FW09</b>	<b>03 06</b>	

I trasformatori 230Vac/12Vac presentati in questo catalogo sono testati con i principali produttori di lampade LED. A causa della velocità dell'adeguamento tecnologico di queste ultime, Lucifero's non può garantire una compatibilità universale delle stesse con i propri trasformatori. Il peso massimo consentito delle lampade LED QR-LP 111 sui nostri proiettori è di 275 g. | The 230Vac/12Vac transformers presented on this catalogue have been tested with the leading LED lamps manufacturers. Due to the pace of the technological update of them, Lucifero's cannot guarantee their universal compatibility with its transformers. The maximum allowed weight of 12V QR-LP 111 LED lamps is of 275 gr | Los transformadores 230Vac/12Vac presentados en este catálogo han sido testados con los principales productores de lámparas LED. Debido a la rápida evolución tecnológica de estas, Lucifero's no puede garantizar una compatibilidad universal de las mismas con nuestros transformadores. El peso máximo admisible de las lámparas LED QR-LP 111 para nuestros proyectores es de 275gr.

DimTF: Versione dimmerabile Taglio di fase / Trailing/leading edge dimmable version / Versione dimmable corte de fase.

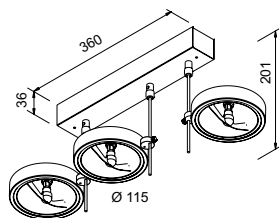

## FLOW D



QR-CB51 GU5,3 12V	W	Dim.TF	A	CODE	Col.	
	1x Led/Halo max 50	x	<b>T.1</b>	<b>FW01</b>	<b>03 06</b>	

DimTF: Versione dimmerabile Taglio di fase / Trailing/leading edge dimmable version / Versione dimmable corte de fase.

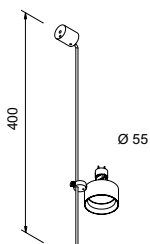

03 - cromo - chrome - cromo

06 - nichel satinato - brushed nichel - nichel satinado

## FLOW 01D



QR-CB51 GU5,3 12V  
 W 1x Led/Halo max 50  
 Dim.TF x  
 A+-D

CODE Col.  
**FW03** **03 06**



I trasformatori 230Vac/12Vac presentati in questo catalogo sono testati con i principali produttori di lampade LED. A causa della velocità dell'adeguamento tecnologico di queste ultime, Lucifero's non può garantire una compatibilità universale delle stesse con i propri trasformatori. | The 230Vac/12Vac transformers presented on this catalogue have been tested with the leading LED lamps manufacturers. Due to the pace of the technological update of them, Lucifero's cannot guarantee their universal compatibility with its transformers. | Los transformadores 230Vac/12Vac presentados en este catálogo han sido testados con los principales productores de lámparas LED. Debido a la rápida evolución tecnológica de estas, Lucifero's no puede garantizar una compatibilidad universal de las mismas con nuestros transformadores.

DimTF: Versione dimmerabile Taglio di fase / Trailing/leading edge dimmable version / Versione dimmable corte de fase.

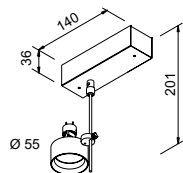

## FLOW 02D



QR-CB51 GU5,3 12V  
 W 2x Led/Halo max 50  
 Dim.TF x  
 A+-D

CODE Col.  
**FW05** **03 06**



I trasformatori 230Vac/12Vac presentati in questo catalogo sono testati con i principali produttori di lampade LED. A causa della velocità dell'adeguamento tecnologico di queste ultime, Lucifero's non può garantire una compatibilità universale delle stesse con i propri trasformatori. | The 230Vac/12Vac transformers presented on this catalogue have been tested with the leading LED lamps manufacturers. Due to the pace of the technological update of them, Lucifero's cannot guarantee their universal compatibility with its transformers. | Los transformadores 230Vac/12Vac presentados en este catálogo han sido testados con los principales productores de lámparas LED. Debido a la rápida evolución tecnológica de estas, Lucifero's no puede garantizar una compatibilidad universal de las mismas con nuestros transformadores.

DimTF: Versione dimmerabile Taglio di fase / Trailing/leading edge dimmable version / Versione dimmable corte de fase.

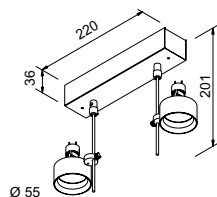

---

**MIMOS**



Apparecchi a parete per illuminazione diretta/indiretta diffusa o per lampade alogene QT-DE 12 78mm R7s. Corpo in metallo finitura verniciata. Completi di vetri temperati diffondenti bianco satinato.

Wall-mounted fixtures for diffused direct/indirect lighting for Halogen Lamps QT-DE 12 78mm R7s. Body in painted metal. Complete of tempered white frosted glasses.

Aparatos de iluminación de pared con luz directa y difusa , para lámparas halógenas QT-DE 12 78mm R7s. Cuerpo en metal pintado. Completo con cristal templado difusión blanco satinado.

---

# MIMOS



QFDE 12 R7s 230V  
78mm

A+C

W  
1x max 120

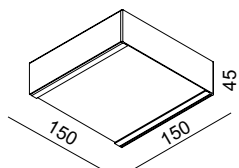

Dim. H  
150X150 45

CODE Col.  
**MI01 01 03**



01 - bianco - white - blanco

03 - cromo - chrome - cromo



## PLANET



Apparecchi da parete e soffitto orientabili per illuminazione diretta/indiretta, per lampade per lampade alogene QT-DE 12 78mm o QT14 c G9 230V. Corpo in metallo. Gruppo ottico in alluminio, orientabile di 360°. Finitura galvanica. Completi di vetri temperati diffondenti sabbiati.

Adjustable wall and ceiling-mounted fixtures for direct/indirect lighting, for halogen QT-DE 12 78mm c QT14 c G9 230V lamps. Metal body. 360° adjustable optic unit, aluminium-made. Plated finish. Complete with diffusing white sanded tempered glasses.

Aparatos de iluminación de pared o techo para iluminación directa / indirecta, para lámparas halógenas QT-DE 12 o 78 mm c QT14 G9 230V. Estructura de metal. Aluminio unidad óptica, que tiene una capacidad de rotación de 360°. Acabado plateado. Completo de vidrio de difusión templado arenado.

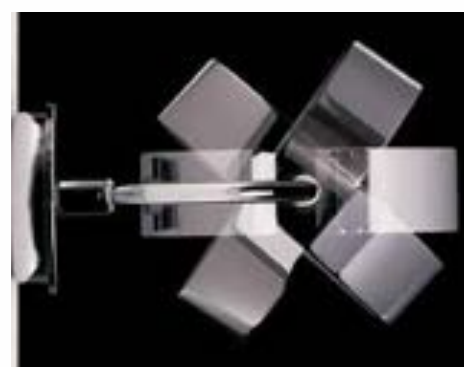

## PLANET



QFDE 12 R7s 230V  
78 mm



A<sup>t</sup>-C

W  
1x max 120

CODE  
PLT00

Col.  
03 06

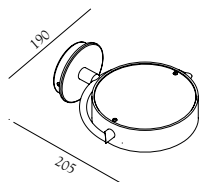

## PLANET R



QFDE 12 R7s 230V  
78 mm



A<sup>t</sup>-C

W  
1x max 120

CODE  
PLR

Col.  
03 06

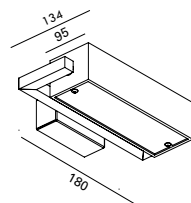

## MINIPLANET Q



QF14 c G9 230V



A<sup>t</sup>-D

W  
1x max 60

CODE  
MPQ01

Col.  
03 06

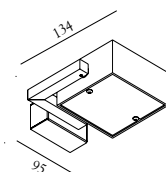

03 - cromo - chrome - cromo

06 - nichel satinato - brushed nichel - nichel satinado

---

## HARIO



Rosone per permettere il decentramento degli apparecchi a sospensione senza necessità di opere murarie. Corpo in metallo dotato di foro per il passaggio del cavo elettrico. Finitura verniciata o galvanica.

Canopy for decentralizing the installation point of hanging fixtures masonry works-free. Metal body with a hole for the passage of the electrical cable. Finish painted or galvanic.

Rosone para la descentralización de las luminarias de techo sin necesidad de trabajos de albañilería. Estructura de metal con un orificio para el paso del cable eléctrico. Con recubrimiento en polvo o galvanizado.

---

# HARIO

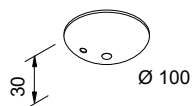

Dim. H  
ø100 30

CODE Col.  
DC 01 02 03 06 12



01 BIANCO-WHITE - BLANCO



02 NERO-BLACK - NEGRO



03 CROMO-CHROME - CROMO



06 NICHEL SATINATO  
BRUSHED NICHEL - NICHEL SATINADO



12 GRIGIO - GREY - GRIS

FLIK FLOK MODULI FINITI - DEFAULT MODULE - MÓDULOS PREDEFINIDOS

## FLIK - FLOK PARETE INDOOR

WALL - PARED

LINEAR LED	W	K	In product	lm/Led	CRI	A	Lmm	CODE	Col.
LINEAR LED 24W/MT 2200lm/MT CRI>80	6,4	3000	478	800	>80	V.1	110	FF01	01 60
	12,8	3000	736	1232	>80	7.1	290	FF02	01 60
	19,2	3000	1104	1848	>80	7.1	850	FF03	01 60
	25,6	3000	1472	2464	>80	7.1	1130	FF04	01 60

Da completare con il relativo alimentatore. To be completed with the relative ballast. A completar con alimentación.



## FLIK - FLOK PARETE OUTDOOR

WALL - PARED

LINEAR LED	W	K	In product	lm/Led	CRI
LINEAR LED 24W/MT 2200lm/MT CRI>80	6,4	3000	312	522	>80

Alimentazione remota non inclusa

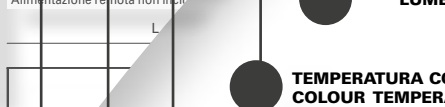

01 - bianco - white - blanco

- SEZIONE SECTION
- NOME NAME
- CODICE FINITURA COLOUR CODE
- SIMBOLOGIA SYMBOL

CODICE PADRE BASE CODE

DIMENSIONE DIMENSION

GRUPPO ALIMENTATORI BALLASTS GROUP

CRI

LUMEN LED

LUMEN PRODUCT

TEMPERATURA COLORE COLOUR TEMPERATURE

POTENZA LAMPADA POWER BULB

CLASSE ENERGETICA ENERGY CLASS

SORGENTE LIGHT SOURCE

GUIDA ALLA LETTURA  
READING GUIDE  
GUÍA DE LECTURA

# APPENDIX

## SPECIFICHE TECNICHE • TECHNICAL SPECIFICATIONS • ESPECIFICACIONES TÉCNICAS

ALIMENTATORI - POWER SUPPLIERS - ALIMENTADORES p.820

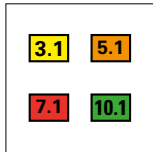

LIVELLO DI ILLUMINAMENTO - LIGHTING LEVEL - NIVEL DE ILUMINACION p.823



CURVE FOTOMETRICHE - PHOTOMETRIC DATA - DATOS FOTOMETRICOS p.824

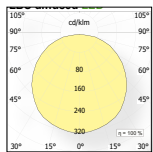

LAMPADINE - BULBS - BOMBILLAS p.833

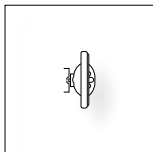

TAGLI A MISURA - CUSTOM CUTS - CORTADO A LA MEDIDA p.834

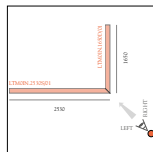

SIMBOLOGIA - SYMBOLS - PICTOGRAFIA p.836

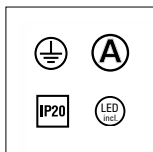

COLORI - COLOURS - ACABADOS p.837

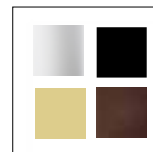

A		ON/ OFF	TAGLIO DI FASE TRAILING EDGE - LEADING EDGE	DALI	PUSH & DIMM	1-10 V	mA	V IN	V OUT RANGE	W	LXPXH (MM)	Ø (MM)	IP
3.1	AE350.8C	●					350	100÷240V	0÷24	0÷8	35x60x21,5	42	20
	AE350.10C	●					350	220÷240V	9÷31	3÷10	37x80x21	45	20
	AE350.10CD	●	●				350	220÷240V	9÷31	3÷10	37x80x21	45	20
	AE700.20CD.MP to be set at 350mA	●		●			350	100÷264V	0÷43	0÷15	52x111x22	55	20
	AE700.20C.10V.MP to be set at 350mA	●			●	●	350	100÷264V	0÷57	0÷15	52x111x22	55	20
3.2	AE350.12C	●					350	220÷240V	8÷36	3÷12	45x123x19	49	20
	AE350.16CD	●	●				350	220÷240V	29÷46	10÷16	38x131x29	46	20
	AE700.20CD.MP to be set at 350mA	●		●			350	100÷264V	0÷43	0÷15	52x111x22	55	20
	AE700.20C.10V.MP to be set at 350mA	●			●	●	350	100÷264V	0÷57	0÷15	52x111x22	55	20
3.3	AE350.16C	●					350	220÷240V	12÷46	4,2÷16	131x38x29	46	20
	AE350.16CD	●	●				350	220÷240V	29÷46	10÷16	38x131x29	46	20
3.4	AE350.16C	●					350	220÷240V	12÷46	4,2÷16	131x38x29	46	20
	AE350.16CD	●	●				350	220÷240V	29÷46	10÷16	38x131x29	46	20
	AE350.25C	●					350	198-264VacV	10÷72	5÷25	131x38x29	46	20
	AE350.25CD	●	●				350	198-264VacV	45÷72	16÷25	131x38x29	46	20
	AE350.50C	●					350	198-264V	66÷143	23÷50	170,5x70,2x32	73	20
	AE700.20CD.MP to be set at 350mA	●		●			350	100÷264V	0÷43	0÷15	52x111x22	55	20
	AE700.20C.10V.MP to be set at 350mA	●			●	●	350	100÷264V	0÷57	0÷15	52x111x22	55	20
	AE700.50CD.MP to be set at 350mA	●		●	●	●	350	99÷264V	0÷112	0÷40	124X79X22	84	20
AE1050.50CD.MP to be set at 350mA	●		●	●	●	350	220÷240V	0÷74	0÷25	79x124x22	84	20	
5.1	AE500.6C	●					500	90÷264V	0÷12	0÷6	68x35x21.5	38	20
	AE700.20C.MP to be set at 500mA	●					500	198-264V	0÷40	0÷20	111x52x22	55	20
	AE700.20CD.MP to be set at 500mA	●		●			500	100÷264V	0÷43	0÷20	52x111x22	55	20
	AE700.20C.10V.MP to be set at 500mA	●			●	●	500	100÷264V	0÷43	0÷20	52x111x22	55	20
	AE700.32CD.MP to be set at 500mA	●		●			500	100÷264V	0÷46	0÷32	67x103x21	72	20
	AE1050.50C.MP to be set at 500mA	●		●	●	●	500	220÷240V	0÷74	0÷25	79x124x22	84	20















A		ON/ OFF	TAGLIO DI FASE TRAILING EDGE - LEADING EDGE	DALI	PUSH & DIMM	1-10 V	mA	V IN	V OUT RANGE	W	LXPXH (MM)	Ø (MM)	IP
5.2	AE500.20C1	●					500	100÷264V	0÷45	0÷20	38x122x28	48	20
	AE700.32CD.MP to be set at 500mA	●		●			500	100÷264V	0÷47	0÷24	67x103x21	72	20
	AE700.32C.10V.MP to be set at 500mA	●			●	●	500	100÷264V	0÷47	0÷24	67x103x21	72	20
	AE1050.50C.MP to be set at 500mA	●					500	220÷240V	0÷72	0÷35	79x124x22	84	20
	AE1050.50CD.MP to be set at 500mA	●		●	●	●	500	220÷240V	0÷72	0÷35	79x124x22	84	20
5.3	AE500.25C	●					500	100÷264V	10÷50	5÷25	38x131x29	46	20
	AE500.25CD	●	●				500	220÷240V	32÷5	16÷25	38x131x29	46	20
5.4	AE500.25C	●					500	100÷264V	10÷50	5÷25	38x131x29	46	20
	AE500.25CD	●	●				500	220÷240V	32÷5	16÷25	38x131x29	46	20
	AE700.32CD.MP to be set at 500mA	●		●			500	100÷264V	0÷47	0÷24	67x103x21	72	20
	AE700.32C.10V.MP to be set at 500mA	●			●	●	500	100÷264V	0÷47	0÷24	67x103x21	72	20
7.1	AE700.11C	●					700	220÷240V	0÷16	0÷11	22x158x19	32	20
	AE700.10CD	●	●				700	220÷240V	6÷16	4÷10	37x80x21	45	20
	AE700.20CD.MP to be set at 700mA	●		●			700	100÷264V	0÷28	0÷20	52x111x22	55	20
	AE700.20C.10V.MP to be set at 700mA	●			●	●	700	100÷264V	0÷28	0÷20	52x111x22	55	20
7.2	AE700.10C	●					700	220÷240V	6÷16	4÷10	37x80x21	45	20
	AE700.10CD	●	●				700	220÷240V	6÷16	4÷10	37x80x21	45	20
	AE700.20CD.MP to be set at 700mA	●		●			700	100÷264V	0÷28	0÷20	52x111x22	55	20
	AE700.20C.10V.MP to be set at 700mA	●			●	●	700	100÷264V	0÷28	0÷20	52x111x22	55	20
7.3	AE700.16C	●					700	198÷264V	6÷23	4,2÷16	38x131x29	46	20
	AE700.16CD	●	●				700	198÷264V	14÷23	10÷16	38x131x29	46	20
	AE700.25C	●					700	220÷240V	21÷36	15÷25	38x131x29	46	20
	AE700.25CD	●	●				700	220÷240V	23÷37	16÷25	52x111x22	46	20
	AE700.32CD.MP to be set at 700mA	●		●			700	100÷264V	0÷46	0÷32	67x103x21	72	20
	AE700.32C.10V.MP to be set at 700mA	●			●	●	700	100÷264V	0÷46	0÷32	67x103x21	72	20
	AE700.40C	●					700	220÷264V	20÷57	0÷40	83x170,5x32	85	20

A		ON/ OFF	TAGLIO DI FASE TRAILING EDGE - LEADING EDGE	DALI	PUSH & DIMM	1-10 V	mA	V IN	V OUT RANGE	W	LXPXH (MM)	Ø (MM)	IP
7.4	AE700.25C	●					700	220÷240V	21÷36	15÷25	38x131x29	46	20
	AE700.25CD	●	●				700	220÷240V	23÷37	16÷25	52x111x22	46	20
10.1	AE1050.48C	●					1050	220÷240V	22÷46	23÷48	71x171x32	76	20
	AE1050.50CD.MP to be set at 1050mA	●		●	●	●	1050	220÷240V	0÷35	0÷50	79x124x22	84	20
V.1	AE30.24VL	●						220-240 VacV	24Vdc	30	251x30x16	34	20
	AE60.24VIP	●						220-240VacV	24Vdc	60	198x44x40	60	65
V.2	AE20.24V	●						220-240 VacV	24Vdc	20	131x38x29	48	20
	AE25.24VIP	●						220-240VacV	24Vdc	25	150x40x30	50	65
	AE30.24VL	●						220-240 VacV	24Vdc	30	251x30x16	34	20
	AE50.24V	●						220-240VacV	24Vdc	50	225x60x36	70	20
	AE60.24VIP	●						220-240VacV	24Vdc	60	198x44x40	60	65
	AE75.24V	●						220-230VacV	24Vdc	75	194x63x30	65	20
	AE75D.24V	●		●				220-240VacV	24Vdc	75	220x47x44	65	20
	AE100.1.24V	●						220-240VacV	24 Vdc	100	201x70x35	79	20
	AE100D.24V	●		●				100-250VacV	24Vdc	100	210x75x35	83	20
	AE100.24VIP	●						220-240VacV	24Vdc	100	270x63 H40,5	76	67
	AE150.24VIP	●						120-240VacV	24Vdc	150	210x69x37	78	67
	AE150D.24VIP	●		●				220-240VacV	24Vdc	150	220x63x35	73	67
T.1	TRAS/70D	●	●					220÷240V	12	2,5÷50Led 2,5÷70Hal	107x32x20	40	20
T.2	TRAS/70D	●	●					220÷240V	12	2,5÷50Led 2,5÷70Hal	107x32x20	40	20
	TRAS/105D	●	●					220÷240V	12	2,5÷55Led 2,5÷105Hal	117x35x22	42	20

# LIVELLO DI ILLUMINAMENTO

## LIGHTING LEVEL - NIVEL DE ILUMINACION (LUX) UNI 10380/A1

	Ambienti medici: 500 750 1000 camere di degenza, sale operatorie, ambulatori, pronto soccorso, corsie, camere aseptiche	Medical space: 500 750 1000 medical rooms, operating rooms, outpatient wards, emergency treatment rooms, wards, aseptic rooms	Entornos medicos: 500 750 1000 habitaciones de los pacientes, salas operatoria, sala operatoria, la cirugía, Primeros auxilios, paillos, salas blancas
	Scuole: 300 500 750 aule, locali didattici, laboratori, sale riunioni	School: 300 500 750 Classrooms, lab and artistic activity-zones, meeting rooms.	Establecimientos educativos: 300 500 750 Aulas, laboratorios and aula de tutoria, aulas comunes de estudio.
	Uffici con videotermini: 200 300 500 con attività a video superiore alle 6 ore continuative	Offices with videoterminals: 200 300 500 with video work more than 6 hours	Oficinas: 200 300 500 con video de actividad de mas de 6 horas consecutivas
	Open space: 200 300 500 uffici, grandi aree, ambienti pubblici, sale d'attesa	Open spaces: 200 300 500 offices, big areas, public spaces, waiting rooms	Open spaces: 200 300 500 oficinas, grandes areas, los espacios publicos, salas de espera
	Arte e cultura: 150 200 300 cinema, teatri, musei, gallerie, chiese, biblioteche, auditori, monumenti	Art and culture: 150 200 300 cinemas, theatres, museums, galleries, churches, libraries, auditoriums, monuments	Art and culture: 150 200 300 cine, teatros, museos, galerias, iglesias, bibliotecas, auditorium, monumentos.
	Ambienti comuni: 150 200 300 corridoi, giro scale, ascensori	Share spaces: 150 200 300 corridors, stairs, lifts	Areas comunes: 150 200 300 pasillos, escala, ascensor.
	Centri commerciali: 500 750 1000 negozi in genere, sale esposizioni, vetrine, supermercati, aeroporti, facciate di negozi	Shopping centres: 500 750 1000 shops in general, showrooms, shop windows, supermarkets, airports, shop fronts	Centro comercial: 500 750 1000 tiendas en general, showrooms, destacados, supermercado, aeropuerto.
	Locali secondari: 150 200 300 sale macchine, cantine, guardaroba, depositi, box, spogliatoi, cucine, bagni	Secondary spaces: 150 200 300 Cellars, workshops, cloakrooms, deposits, boxes, bathrooms, kitchens, dressingrooms.	Espacio de secundaria: 150 200 300 salas de maquinas, bodega, armario, deposito, box, vestuario, cocina, toilette.
	Locali generali: 150 200 300 abitazioni, alberghi, camere	General spaces: 150 200 300 residential areas, hotels, rooms	Local general: 150 200 300 casa, hotels, dormitorio
	Industrie alimentari: 200 300 500	Alimentary industries: 200 300 500	Industrias de productos alimentacios: 200 300 500
	Ristoranti, bar, mense: 150 200 300	Resturants, bars, refectories: 150 200 300	Restaurantes, bar, cantina: 150 200 300
	Uffici tecnici: 500 750 1000	Technical officies: 500 750 1000	Oficina tecnica: 500 750 1000

# CURVE FOTOMETRICHE

## PHOTOMETRIC DATA - DATOS FOTOMETRICOS

LBS

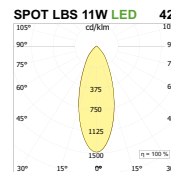
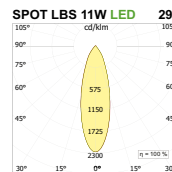
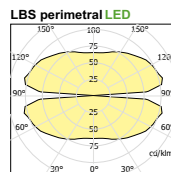
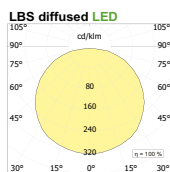

LEVA

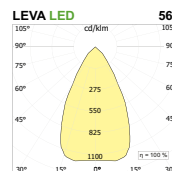
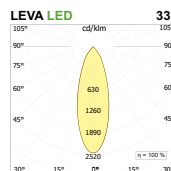
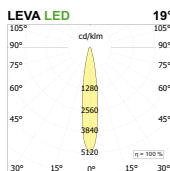

FARETEN

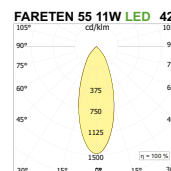
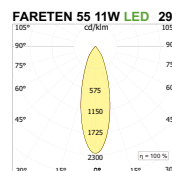
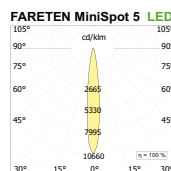
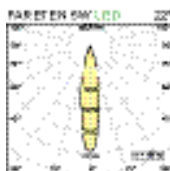

MICROFILE

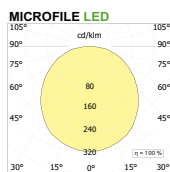

MINIFILE

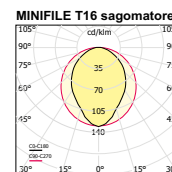
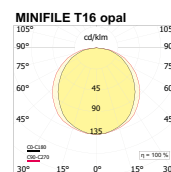
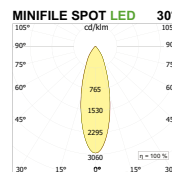
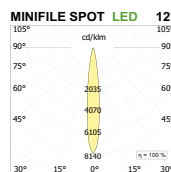
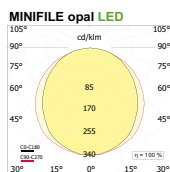

MINIFILE  
OPENLIGHT  
OPENLIGHT  
TRACK

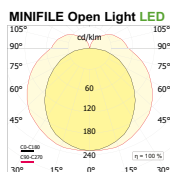

FILE

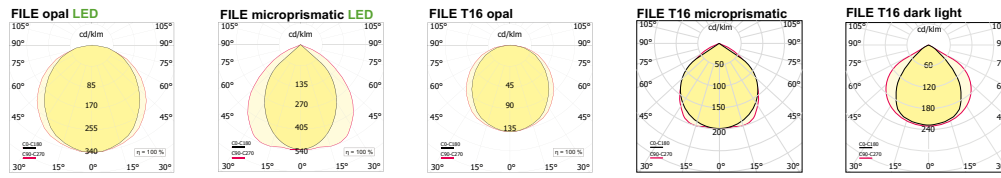

FILE 2  
FILE 2 TRACK

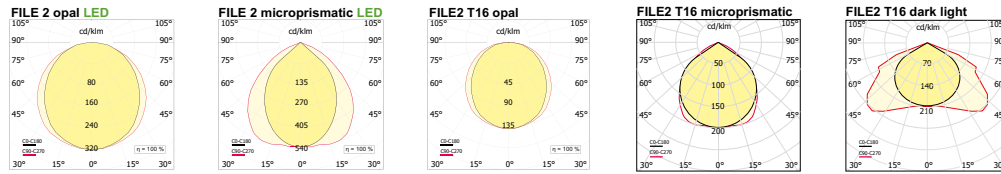

FILE 2  
TRIMLESS

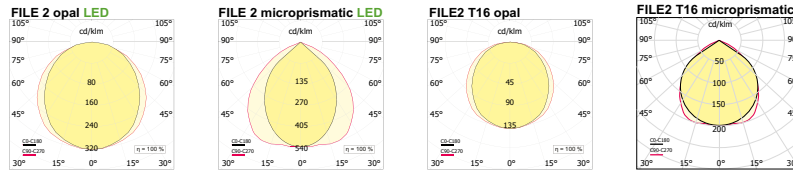

FILE H

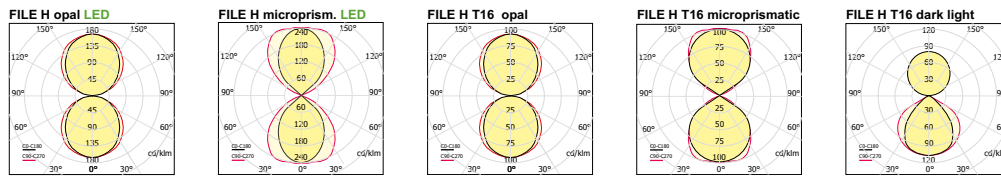

FILE 2H

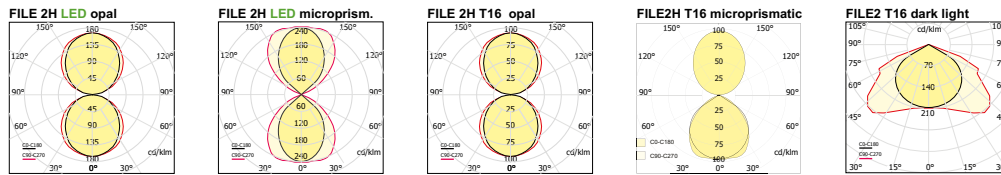

FLIK FLOK

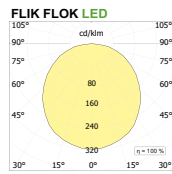

SEGMENT

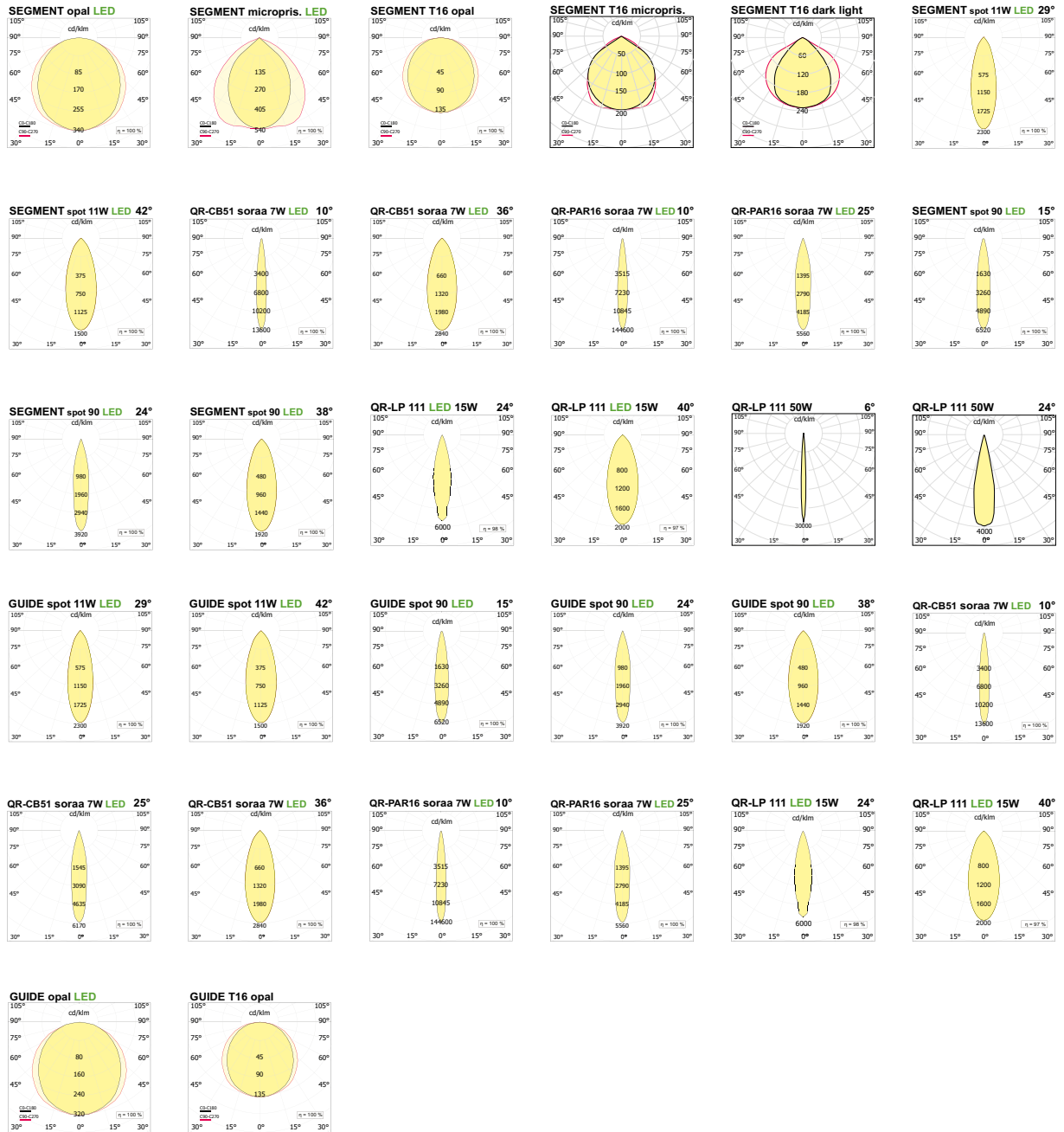

GUIDE

CI

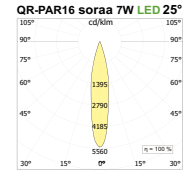
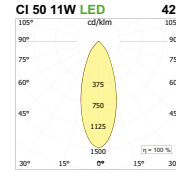
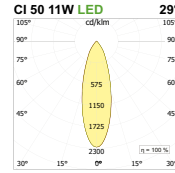
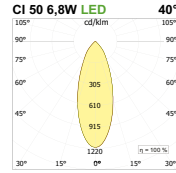
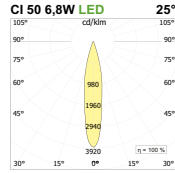
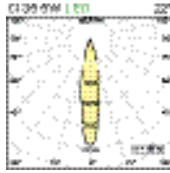

NYX

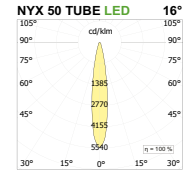
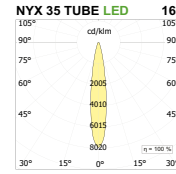
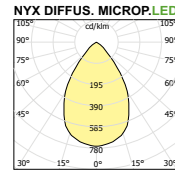
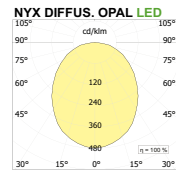
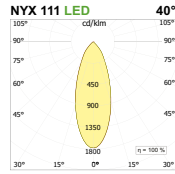
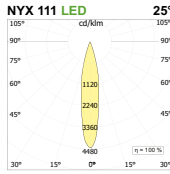
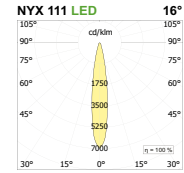
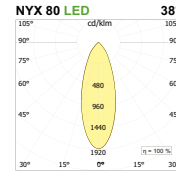
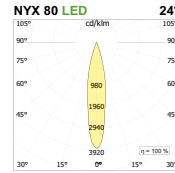
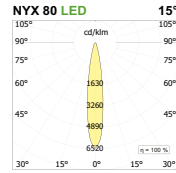
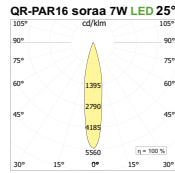
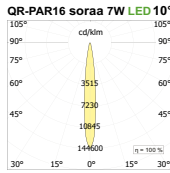
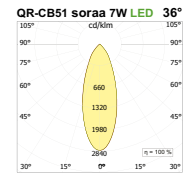
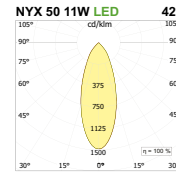
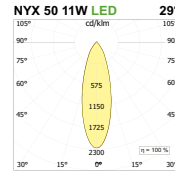
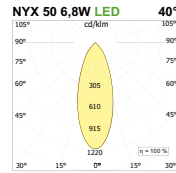
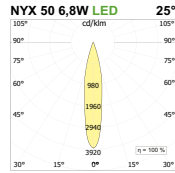
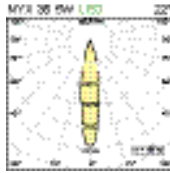

TWENTY 7

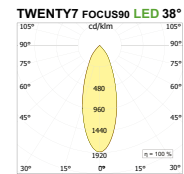
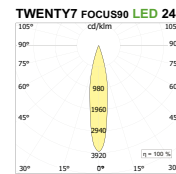
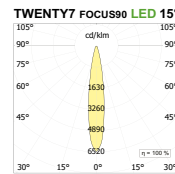
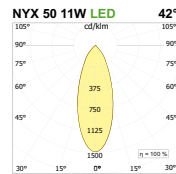
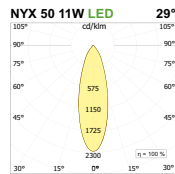
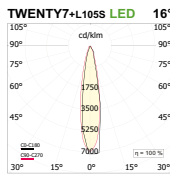
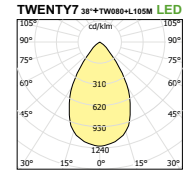
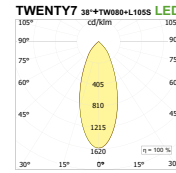
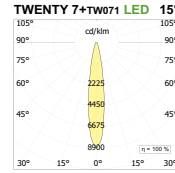
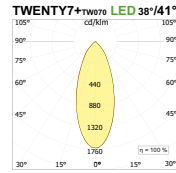
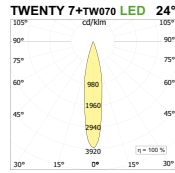
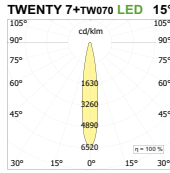



LIGHT DRUM

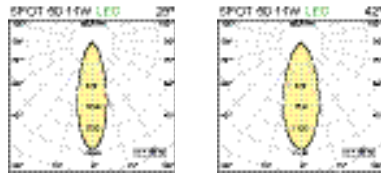

MOVE

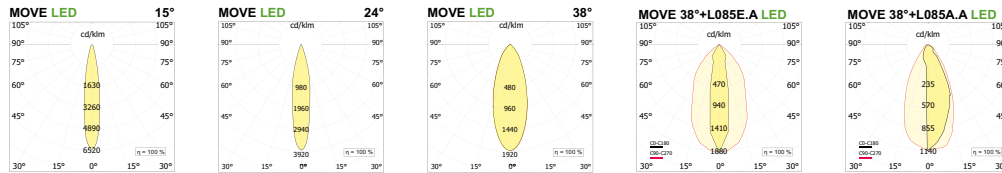

INCAS

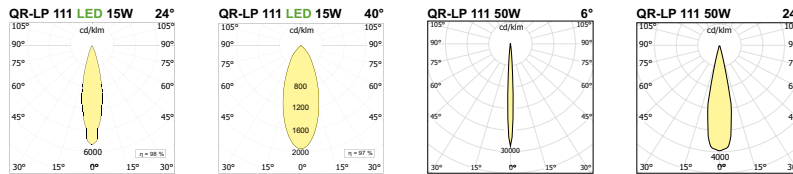

INCAS DIFFUSED

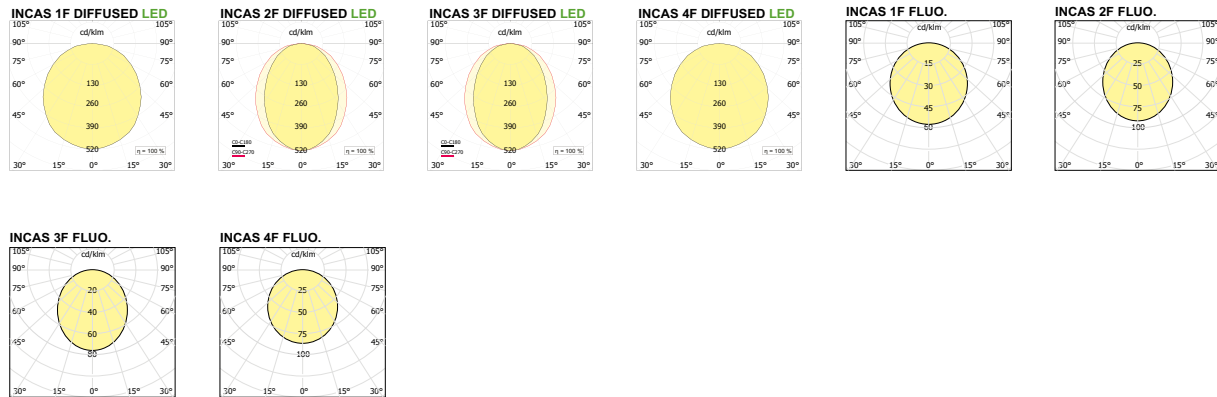

MINI INCAS

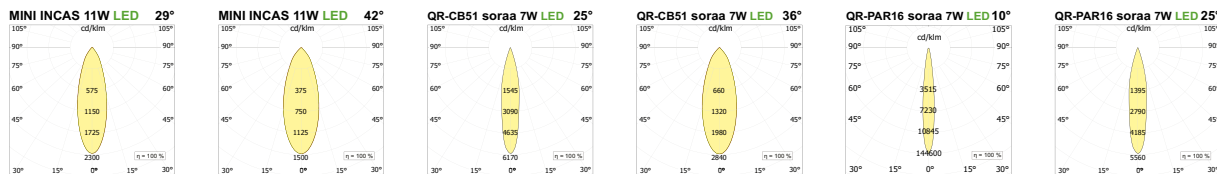



SEMPLICE  
PHAR  
PRO-IN

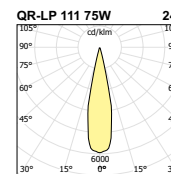
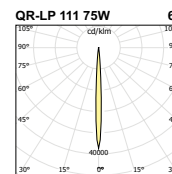
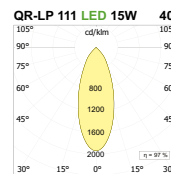
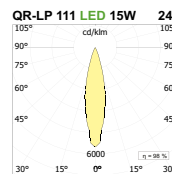
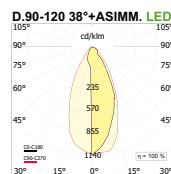
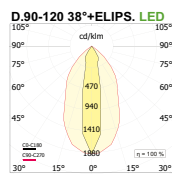
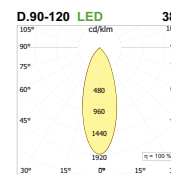
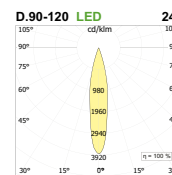
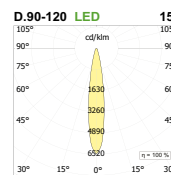
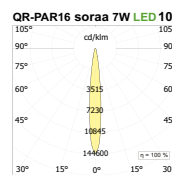
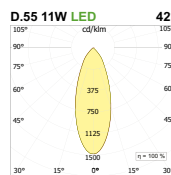
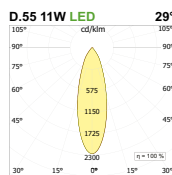

BICUBO

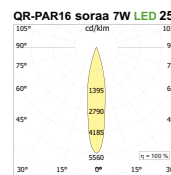
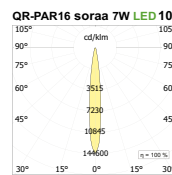
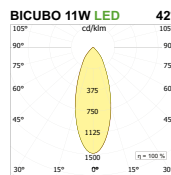
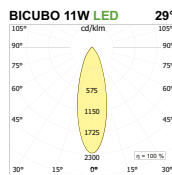

EXTENSOR

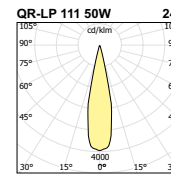
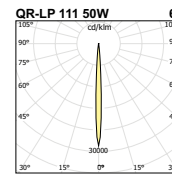
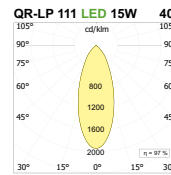
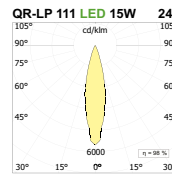
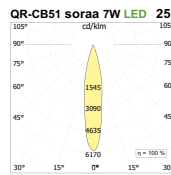
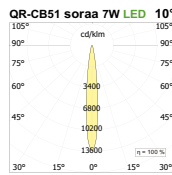

ICEMENTI

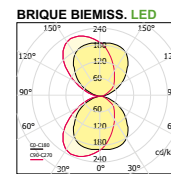
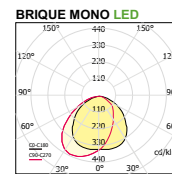
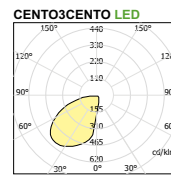
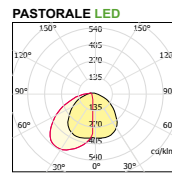
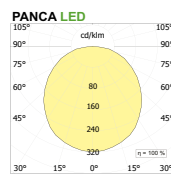
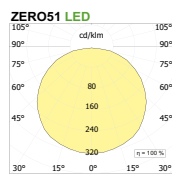

APP-LIQUES

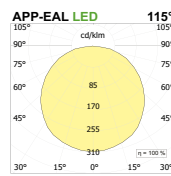
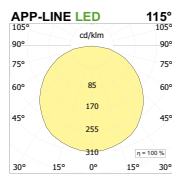

## I-PIPEDI

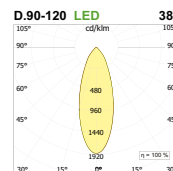
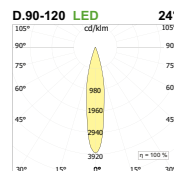
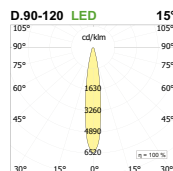
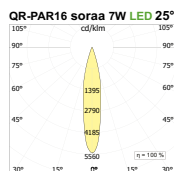
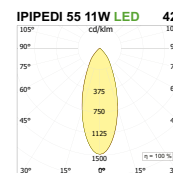
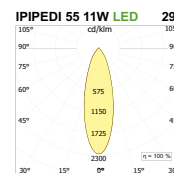
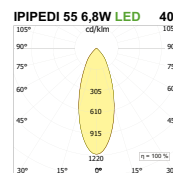
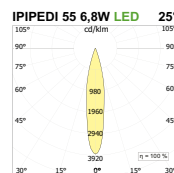
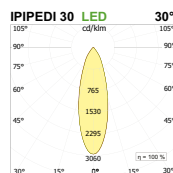
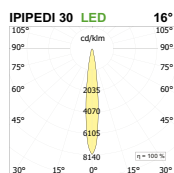

## MANINE

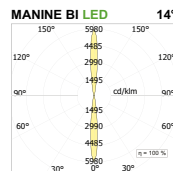
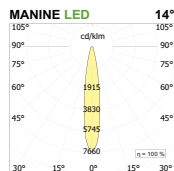

## RIGO

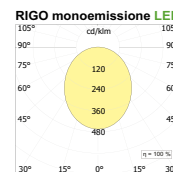
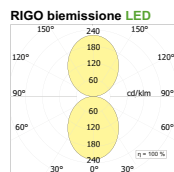

## SCENA

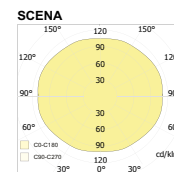

## STRUTTURA

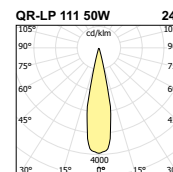
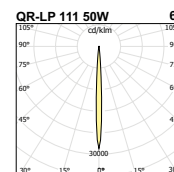
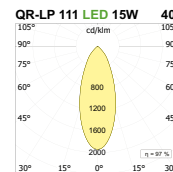
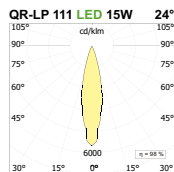

## FLOW ORION

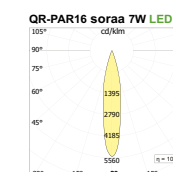
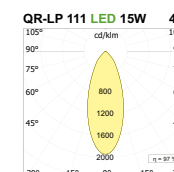
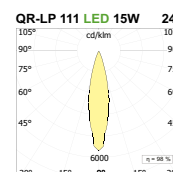
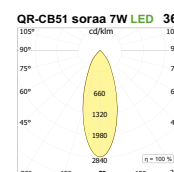
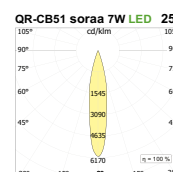
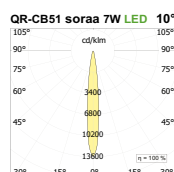

FORMAT

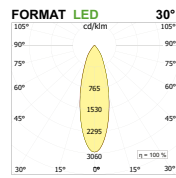
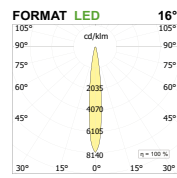



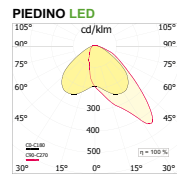



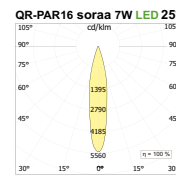
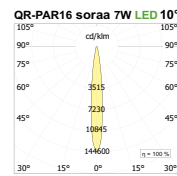
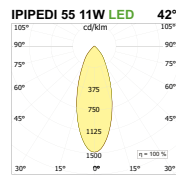
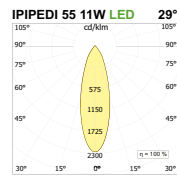







PIEDINI



IN-OUT

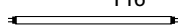

## LAMPADINE - BULBS - BOMBILLAS

HALOGEN LAMPS					FLUORESCENT LAMPS					
	ZVEI CODE	POWER (W)	LUMINOUS FLUX (LM)	LAMP HOLDER		ZVEI CODE	POWER (W)	LUMINOUS FLUX (LM)	LAMP HOLDER	
	QT9-LP	20	320	G4		TC-DEL	10/840	600	G24 <sub>0</sub> -1	
	QT12-LP	35	600	GY6,35	13/840		900	G24 <sub>0</sub> -1		
		50	930	GY6,35	13/827		900	G24 <sub>0</sub> -1		
	QT14 c	25	210	G9	18/840		1200	G24 <sub>0</sub> -2		
		40	410	G9	18/830		1200	G24 <sub>0</sub> -2		
		60	700	G9	18/827		1200	G24 <sub>0</sub> -2		
		75	890	G9	26/840		1680	G24 <sub>0</sub> -3		
		20	200	G9	26/830		1680	G24 <sub>0</sub> -3		
		33	460	G9	26/827		1620	G24 <sub>0</sub> -3		
		48	740	G9						
	60	980	G9							
	QT-DE12	80/74,9 MM	1380	R7S		TC-L	18/840	1200	2G11	
		120/74,9 MM	2220	R7S	18/830		1200	2G11		
		120/114,2 MM	2220	R7S	18/827		1200	2G11		
		160/114,2 MM	3100	R7S	24/840		1800	2G11		
	QT32 c	75	1000	E27	24/830		1800	2G11		
		100	1800	E27	36/840		2900	2G11		
		150	2870	E27	36/830		2900	2G11		
		205	4200	E27	36/827		2900	2G11		
	QR-LP 111	50 (4°)	40000 CD	G53			TC-TEL	13/840	900	GX24 <sub>0</sub> -1
		50 (8°)	20000 CD	G53	18/840			1200	GX24 <sub>0</sub> -2	
		50 (24°)	4000 CD	G53	18/830	1200		GX24 <sub>0</sub> -2		
		50 (45°)	1700 CD	G53	26/840	1800		GX24 <sub>0</sub> -1		
		75 (8°)	30000 CD	G53	26/830	1800		GX24 <sub>0</sub> -3		
		75 (24°)	5300 CD	G53	26/827	1800		GX24 <sub>0</sub> -3		
		75 (45°)	2000 CD	G53	32/840	2400		GX24 <sub>0</sub> -3		
		100 (8°)	48000 CD	G53	32/830	2400		GX24 <sub>0</sub> -3		
		100 (24°)	8500 CD	G53	32/827	2400		GX24 <sub>0</sub> -3		
		100 (45°)	2800CD	G53	42/840	3200		GX24 <sub>0</sub> -4		
					42/830	3200		GX24 <sub>0</sub> -4		
					42/827	3200		GX24 <sub>0</sub> -4		
	QR-CB35	20 (30°)	600 CD	GU4		T16	24/840	1700	G5	
		35 (30°)	1200 CD	GU4	24/830		1700	G5		
	QR-CB51	20 (36°)	500 CD	GU5,3	39/840		3220	G5		
		35 (38°)	1000 CD	GU5,3	39/830		3220	G5		
		50 (38°)	1600 CD	GU5,3	49/840		4165	G5		
		20 (38°)	780 CD	GU5,3	49/830		4165	G5		
		35 (38°)	1500 CD	GU5,3	54/840		4450	G5		
		50 (38°)	2200 CD	GU5,3	54/830		4450	G5		
	QPAR16	35 (50°)	300 CD	GU10	80/840		6150	G5		
		50(25°)	950 CD	GU10	80/830		6150	G5		
		50(50°)	400 CD	GU10	14/830		1230	G5		
	QPAR20	50 (30°)	1100 CD	E27	21/830		1910	G5		
					28/830	2640	G5			
	QPAR30	75 (30°)	2000 CD	E27	35/830	3320	G5			
		100 (30°)	3300 CD	E27						

## TAGLI A MISURA - CUSTOM CUTS - CORTADO A LA MEDIDA

Come ordinare profili, diffusori, sagomatori, dissipatori di lunghezza lineare non standard o con l'estremità tagliata a 45° - How to order profiles, diffusers, shapers or heatsinks in a non-standard linear length or with ends 45°-angle cut. - Como pedir perfiles, difusores, moldeadores, disipadores de largo lineal no estándar o con corte a 45°.

A) PROFILO, DIFFUSORE, SAGOMATORI, DISSIPATORE DI LUNGHEZZA LINEARE NON STANDARD – PROFILE, DIFFUSER, SHAPERS, HEATSINK OF A NON-STANDARD LINEAR LENGTH - PERFIL, DIFUSOR, MOLDEADORES, DISIPADOR DE LARGO LINEAL NO ESTANDAR

- Scegliere il codice "misura/XX" del prodotto desiderato – choose the "misura /XX" ref. code of the desired product - Elegir el código "medida (misura)/XX" del producto deseado (Minifile, File, FileH, File2, File2H, Containers, Segment)
- Sostituire alla parola "misura" la lunghezza desiderata in mm. – replace the word "misura" with the desired length in mm. - Sustituir la palabra "medida (misura)" por la medida deseada en mm.
- Calcolare il prezzo seguendo le istruzioni riportate sul listino prezzi – to calculate the price follow the instructions reported on the pricelist. - Calcular el precio siguiendo las instrucciones detalladas en el listado de precios.
- Esempio – example - ejemplo:

Profilo MINIFILE Soffitto bianco di lunghezza 2.530 mm. – MINIFILE Ceiling profile white of 2.530 mm. - Perfil MINIFILE plafón blanco de 2.530 mm de largo LTM00.misura diventa - becomes - se convierte en LTM00.2530/01

B) PROFILO, DIFFUSORE, SAGOMATORI, DISSIPATORE CON UNA O DUE ESTREMITA' TAGLIATE A 45° – PROFILE, DIFFUSER, SHAPERS, HEATSINK WITH ONE OR BOTH ENDS 45°-ANGLE CUT - B) PERFIL, DIFUSOR, MOLDEADOR, DISIPADOR CON UNO DOS CORTES A 45°

- Scegliere il codice "misura/XX" del prodotto desiderato – choose the "misura /XX" ref. code of the desired product - Elegir el código "medida (misura)/XX" del producto deseado (Minifile, File, FileH, File2, File2H, Containers, Segment)
- Sostituire alla parola "misura" la lunghezza desiderata in mm. – replace the word "misura" with the desired length in mm. - Sustituir la palabra "medida (misura)" por la medida deseada en mm.
- Aggiungere alla misura le lettere D (destra), S (sinistra), L (sinistra/destra), Z (sinistra/sinistra), R (destra/destra) o G (parete/soffitto) a seconda del taglio desiderato, seguendo gli esempi sotto riportati – Add to the dimension the letters D (right), S (left), L (right/left), Z (left/left), R (right/right) or G (wall/ceiling) according to the desired cut, following the examples hereunder - Añadir a la medida la letra D (derecha), S (izquierda), L (izquierda/derecha), Z (izquierda/izquierda), R (Derecha/derecha) o G (pared/techo) según el corte deseado, siguiendo los ejemplos abajo señalados.
- Calcolare il prezzo seguendo le istruzioni riportate sul listino prezzi – to calculate the price follow the instructions reported on the pricelist. - Calcular el precio siguiendo las instrucciones detalladas en el listado de precios.
- Esempi – examples – ejemplos:

Composizione a "L" di due profili MINIFILE Incasso bianco, 2.530 x 1.650 mm. e relativi tagli a 45° Sinistro e Destro. - "L" shaped composition of MINIFILE Recessed profiles white, 2.530 x 1.650 mm. and relative 45°-angle Left and Right cuts. - Composición a "L" de dos perfiles MINIFILE empotrados blanco, 2.530 x 1.650 mm. y los correspondientes cortes a 45° izquierda y derecha.

Composizione a "U" di tre profili MINIFILE Incasso bianco, 2.530 x 1.650 x 2.530 mm. e relativi tagli a 45° Sinistro e Destro - "U" shaped composition of MINIFILE Recessed profiles white, 2.530 x 1.650 x 2.530 mm. and relative 45°-angle Left and Right cuts. - Composición a "U" de tres perfiles MINIFILE empotrados blanco, 2.530 x 1.650 x 2.530 mm. y los correspondientes cortes a 45° izquierda y derecha.

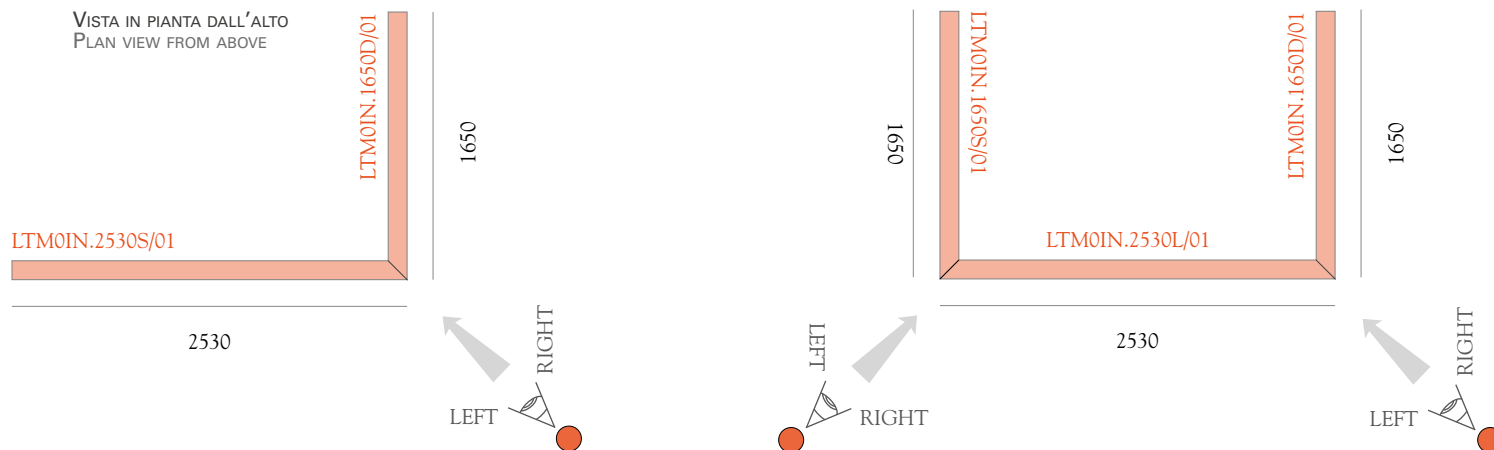

POSIZIONE DELL'OSSERVATORE PER DETERMINARE IL TAGLIO SINISTRO E DESTRO  
OBSERVER'S POSITION TO DETERMINE THE RIGHT AND LEFT CUT



Composizione a "Z" di tre profili MINIFILE Incasso bianco, 2.530 x 1.650 x 2.530 mm. e relativi tagli a 45° Sinistro e Destro. - "Z" shaped composition of MINIFILE Recessed profiles white, 2.530 x 1.650 x 2.530 mm. and relative 45°-angle Left and Right cuts. - Composición a "Z" de tres perfiles MINIFILE empotrados blanco, 2.530 x 1.650 x 2.530 mm. y los correspondientes cortes a 45° izquierda y derecha.

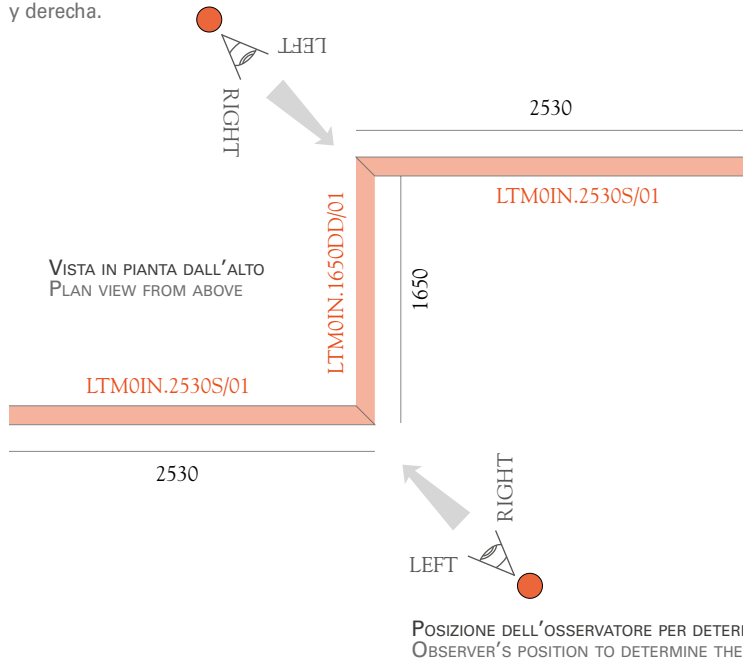

Composizione a "parete-soffitto" di due profili MINIFILE Incasso bianco, 2.530 x 1.650 mm. e relativi tagli a 45° - "Wall-ceiling" shaped composition of MINIFILE Recessed profiles white, 2.530 x 1.650 mm. and relative 45° angle cuts. - Composición a "pared-techo" de dos perfiles MINIFILE empotrados blanco, 2.530 x 1.650 mm, y los correspondientes cortes a 45°.

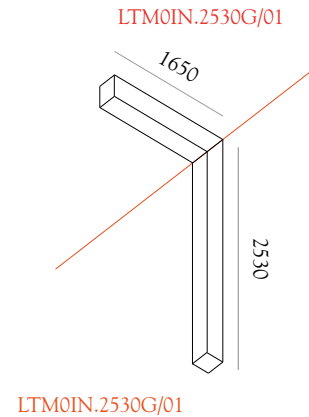

## NOTE IMPORTANTI – IMPORTANT NOTES – NOTA IMPORTANTE

Attenzione: leggere variazioni di colore dei LED sono da considerarsi normali (soprattutto in integrazioni di ordini, per il naturale calare dei lumen di quelli usati) |Note: slight colour temperature variations of the LED's sources are to be considered normal (particularly, due to the technical development and to the change of the luminous flux caused by their use, the LED modules delivered subsequently to the first delivery may differ in the luminous flux and light colour). | Nota: ligeras variaciones en LEDs colore son considerarsi normales (en particular, los módulos LED entregados posteriormente a la primera entrega pueden diferir en el flujo luminoso y color de la luz por la declinación natural de los lúmenes de los utilizados)

Determinazione della lunghezza delle cassaforme a misura LTMF:misura / LTF1:misura / LTF2:misura: aggiungere 3 mm. alla lunghezza totale del prodotto che si intende inserire al suo interno. |To define the length of the wallboxes with custom length LTMF:misura / LTF1:misura / LTF2:misura: add 3 mm. to the total length of the product going inside the wallbox itself. |Cálculo de la longitud de la caja a medida LTMF:misura/LTF1:misura/LTF2:misura: Añadir 3 mm. a la longitud total del producto que se debe de colocar en su interior.

Determinazione della lunghezza prodotto Container a misura LTMF:misura / LTF1:misura / LTF2:misura: aggiungere 8 mm. alla lunghezza totale del prodotto che si intende inserire al suo interno. |To define the length of the Container with custom length LTMF:misura / LTF1:misura / LTF2:misura: add 8 mm. to the total length of the product going inside the Container itself. |Cálculo de la longitud deL contenedor a medida LTMF:misura/LTF1:misura/LTF2:misura: Añadir 8 mm. a la longitud total del producto que se debe de colocar en su interior.

Compatibilità trasformatori 230V/12V con lampade LED – 230V/12V transformer's compatibility with LED lamps. - Compatibilidad transformadores 230V/12V con lámparas LED. I trasformatori 230Vac/12Vac presentati in questo catalogo sono testati con i principali produttori di lampade LED. A causa della velocità dell'adeguamento tecnologico di queste ultime, Lucifero's non può garantire una compatibilità universale delle stesse con i propri trasformatori. Per maggiori informazioni consultare il sito [www.luciferos.it](http://www.luciferos.it) |The 230Vac/12Vac transformers presented on this catalogue have been tested with the leading LED lamps manufacturers. Due to the pace of the technological update of them, Lucifero's cannot guarantee their universal compatibility with its transformers. For more info visit our website [www.luciferos.it](http://www.luciferos.it) | Los transformadores 230Vac/12Vac presentados en este catálogo han sido testados con los principales productores de lámparas LED. Debido a la rápida evolución tecnológica de estas, Lucifero's no puede garantizar una compatibilidad universal de las mismas con nuestros transformadores. Para mayor información consultar el sitio [www.luciferos.it](http://www.luciferos.it).

Peso max. lampade QR-LP 111 LED 12V– max weight of 12V QR-LP 111 LED lamps. - Peso máximo lámparas QR-LP 111 LED 12V.

Il peso massimo consentito delle lampade LED QR-LP 111 sui nostri proiettori è di 275 g -The maximum allowed weight of 12V QR-LP 111 LED lamps is of 275 gr - El peso máximo admisible de las lámparas LED QR-LP 111 para nuestros proyectores es de 275gr.

	SIMBOLOGIA	SIMBOLOGY	PICTOGRAFIA				
	Apparecchio in classe III Apparecchio in cui la protezione contro la scossa elettrica si basa sull'alimentazione a bassissima tensione di sicurezza e in cui non si generano tensioni superiori alla stessa. Nota: un apparecchio in classe III non deve essere provvisto di messa a terra di protezione.	Class III appliance Appliance where protection against electric shock is based on a very low safety voltage. No earth attachment is required.	Class III Luminaria en que la protección contra los choques eléctricos recae en la alimentación a muy baja tensión de seguridad.		Indica che l'apparecchio va installato a soffitto.	Ceiling appliance.	Luminaria da techo.
					Indica la misura di taglio per l'installazione ad incasso dell'apparecchio.	Hole for recessed fixture.	Medida de recorte de techo o pared.
					Emissione luminosa verso il basso e l'alto.	Direction of the light upwards and downwards.	Dirección de la luz hacia arriba y hacia abajo.
					Emissione luminosa verso l'alto.	Direction of the light upwards.	Dirección de la luz hacia lialto.
					Emissione luminosa verso il basso.	Direction of the light downwards.	Dirección de la luz hacia abajo.
					Emissione luminosa asimmetrica.	Asymmetrical light	Dirección de la luz asimétrica.
					Emissione luminosa larga verso l'alto e fascio stretto verso il basso.	Direction of the light towards the high and narrow beam toward bottom.	Dirección de la luz hacia arriba y haz estrecho hacia abajo.
					Emissione luminosa diretta.	Direct light.	Luz directa.
					Emissione luminosa indiretta.	Indirect light.	Luz indirecta.
					Led incluso	Led included	Led incluido
					Lampadina esclusa	Lamp excluded	Lampara no incluido
				DALI	Lampada compatibile con sistemi di controllo digitali DALI (Digital Addressable Lighting Interface)	Compatible lamp with digital control systems DALI (Digital Addressable Lighting Interface)	Lámpara compatible con los sistemas digitales de control DALI (Digital Addressable Lighting Interface)
				1-10V	Lampada compatibile con sistemi analogici di controllo 1-10V	Compatible lamp with analogical systems control 1-10V	Lámpara compatible con los sistemas analógicos para controlar 1-10V
				T&D	Lampada comandabile tramite un pulsante normalmente aperto privo di potenziale	Lamp controlled by a normally open button without potential.	Lámpara controlado por un botón normalmente abierto y sin potencial.
				DF	Lampada comandabile tramite un dimmer a taglio di fase discendente (Trailing edge)	Lamp controlled by a descending phase cut dimmer (Trailing edge).	Lámpara controlada por una fase descendente corta dimmer (Trailing edge)
					Sorgente Led inclusa.	Led source included.	Led incluido.
					Indica la misura necessaria per l'inserimento del trasformatore.	Necessary space to insert the power supply	Indica la medida necesaria para la inserción del transformador.
				A	Vedi tabella alimentatori.	See power suppliers table.	Ver alimentadores de mesa.
					Vedi curve fotometriche.	See photometric data.	Ver datos fotométricos.
					Indica che l'apparecchio va installato a parete.	Wall appliance.	Luminaria da pared.
					Grado di protezione Stabilisce un sistema per la classificazione degli apparecchi elettrici in base al grado di protezione fornito dagli involucri degli stessi. I simboli utilizzati per indicare questo grado di protezione sono costituiti dalle lettere "IP" seguite da due cifre caratteristiche: -la prima cifra indica la protezione contro la penetrazione dei corpi solidi e polvere; -la seconda cifra indica la protezione contro la penetrazione dei liquidi.	Protection degree Establishes a system for the classification of electrical appliances based on the degree of protection consist of the letter "P" followed by two distinguishing numbers: -the first number indicates the protection against solid objects and dust; -the second number indicates the protection against penetration of liquid.	Grado deproteccion IP De acuerdo con la norma, las luminarias se clasifican en funcion de la proteccion derivada da sus elementos constructivos. La nomenclatura
					Alimentatore incluso.	Ballast included.	Balasto incluido.
					Alimentatore escluso.	Ballast excluded.	Balasto no incluido.
					Lampada protetta per un massimo di 100° in superficie.	Lamp protected of maximum temperatures of 100°C in surface.	Luminaria protegida de Temperaturas maximas de 100°C en superficie.
					Apparecchio idoneo per essere installato direttamente su legno.	Adequate equipment for direct mounting in wood.	Equipo adecuado para el montaje directo en madera.
					ENEC (European Norms Electrical Certification) contrassegno di test riconosciuto a livello Europeo che conferma che il dispositivo ha superato i test ENEC.	NEC (European Norms Electrical Certification) is the high quality Euro Mark for electrical products that demonstrates compliance with European standards.	ENEC (European Norms Electrical Certification) es la marca europea de calidad para los productos eléctricos que demuestra el cumplimiento de las normas europeas.
					Trasformatore di sicurezza protetto contro i corto circuiti.	Safety transformer protected against short-circuits.	Transformador de seguridad protegida contra los cortocircuitos
					Possibilità di posizionare il trasformatore elettronico remoto.	Electronic transformer for possible independent installation.	Equipo electrónico de posible instalación independiente.
					Carrabile.	Carriageable.	Transitable.
				SELV	Indica che il prodotto in bassissima tensione è protetto contro i contatti diretti e indiretti con tensione nominale < 60V.	Indicates that the product in very low voltage is protected against direct and indirect contacts with rated voltage <60V.	Indica que el producto de muy baja tensión está protegida contra los contactos directos e indirectos con tensión nominal <60V.

# LEGENDA COLORI - FINISHINGS - ACABADOS

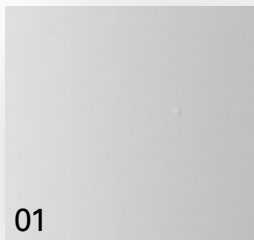

01

BIANCO - WHITE - BLANCO



02

NERO - BLACK - NEGRO



03

CROMO - CHROME - CROMO

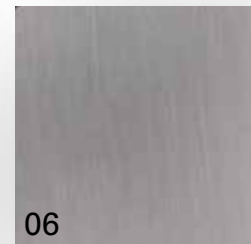

06

NICHEL SATINATO - BRUSHED NICHEL -  
NICHEL SATINADO



08

OTTONE BRUNITO -  
BURNISHED BRASS - LATON PULIDO



12

GRIGIO - GREY - GRIS

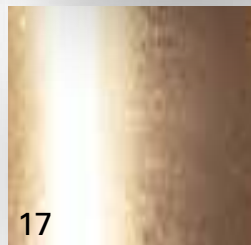

17

OTTONE NATURALE - NATURAL BRASS -  
LATON NATURAL

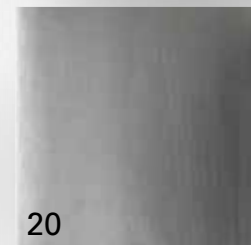

20

ACCIAIO SATINATO -  
BRUSHED STEEL - ACERO SATINADO



27

OSSIDATO ALLUMINIO - OXIDISED ALUMI-  
NIUM - OXIDADO ALUMINIO

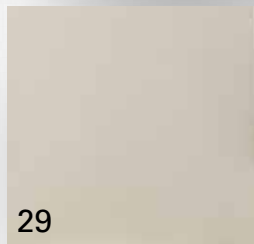

29

CAPPUCCINO

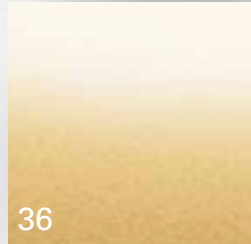

36

ORO - GOLD - ORO

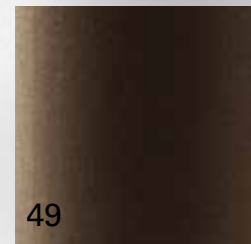

49

MOKA



60

VERNICIATO COR-TEN - COR/TEN PAINTED -  
PINTADO COR-TEN

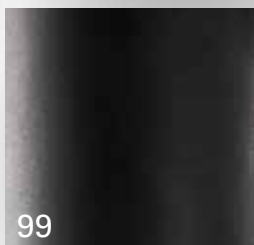

99

GRAFITE - GRAPHITE - GRAFITO

COMPOSIZIONE CODICE D'ORDINE - COMPOSITION ORDER CODE - CÓDIGO DE PEDIDO COMPOSICIÓN

L. mm	W	CODE	COL.
587	1x14-24W G5 230V	LTM083	01 02 27

LTM083/01

## Index

- A
- APE01 PAG.707  
APE02 PAG.707  
APEB1 PAG.707  
APEB2 PAG.707  
APS01 PAG.706  
APS02 PAG.706  
APSB1 PAG.706  
APSB2 PAG.706  
AT132/50 PAG.803  
AT132/60 PAG.803  
AT132/80 PAG.803
- B
- BC01.927F PAG.623  
BC01.927S PAG.623  
BC01.930F PAG.623  
BC01.930S PAG.623  
BC01.940F PAG.623  
BC01.940S PAG.623  
BC05 PAG.623  
BC07 PAG.623  
BC30.927F PAG.623  
BC30.927S PAG.623  
BC30.930F PAG.623  
BC30.930S PAG.623  
BC30.940F PAG.623  
BC30.940S PAG.623  
BC34 PAG.623  
BC36 PAG.623
- C
- C503 PAG.729  
CC1AM PAG.521  
CC2AM PAG.521  
CS.A12V PAG.729  
CS.AST5 PAG.729  
CST.001.830 PAG.52  
CST.001.840 PAG.52  
CST.002.830 PAG.52  
CST.002.840 PAG.52  
CST.003.830 PAG.52  
CST.003.840 PAG.52  
CST.011.830 PAG.52  
CST.011.840 PAG.52  
CST.012.830 PAG.52  
CST.012.840 PAG.52  
CST.013.830 PAG.52  
CST.013.840 PAG.52  
CST.021.830 PAG.52  
CST.021.840 PAG.52  
CST.022.830 PAG.52  
CST.022.840 PAG.52  
CST.023.830 PAG.52  
CST.023.840 PAG.52
- D
- DC PAG.817  
DR51.927F PAG.487  
DR51.927S PAG.487  
DR51.930F PAG.487
- DR51.930S PAG.487  
DR51.940F PAG.487  
DR51.940S PAG.487  
DR51G PAG.487  
DR51Q PAG.487  
DRUM PAG.487  
DS2 PAG.729  
DS3 PAG.729
- F
- FF0D.1000 PAG.370  
FF0D.2000 PAG.370  
FF0D.3000 PAG.370  
FF0D.misura PAG.370  
FF01 PAG.366  
FF02 PAG.366  
FF03 PAG.366  
FF04 PAG.366  
FF05 PAG.366  
FF06 PAG.366.756  
FF07 PAG.366.756  
FF11 PAG.371  
FF12 PAG.371  
FF13 PAG.371  
FF14 PAG.371  
FFGA PAG.370  
FFTP PAG.370  
FR001.927F PAG.98  
FR001.927FD PAG.98  
FR001.930F PAG.98  
FR001.930FD PAG.98  
FR002.927F PAG.98  
FR002.927FD PAG.98  
FR002.930F PAG.98  
FR002.930FD PAG.98  
FR003.927S PAG.98  
FR003.927SD PAG.98  
FR003.930S PAG.98  
FR003.930SD PAG.98  
FR004.927F PAG.99  
FR004.927FD PAG.99  
FR004.927S PAG.99  
FR004.927SD PAG.99  
FR004.930F PAG.99  
FR004.930FD PAG.99  
FR004.930S PAG.99  
FR004.930SD PAG.99  
FR005.927F PAG.99  
FR005.927FD PAG.99  
FR005.930F PAG.99  
FR005.930FD PAG.99  
FR021.927F PAG.103, 210, 232  
FR021.927FD AG.103, 210, 232  
FR021.930F PAG.103, 210, 232  
FR021.930FD PAG.103, 210, 232  
FR022.927F PAG.103, 210, 232  
FR022.927FD PAG.103, 210, 232  
FR022.930F PAG.103, 210, 232  
FR022.930FD PAG.103, 210, 232  
FR023.927S PAG.103, 210, 232  
FR023.927SD PAG.103, 210, 232  
FR023.930S PAG.103, 210, 232  
FR023.930SD PAG.103, 210, 232
- FR024.927F PAG.104, 304  
FR024.927FD PAG.104, 304  
FR024.927S PAG.104, 304  
FR024.927SD P.AG.104, 304
- FR024.930F PAG.104, 304  
FR024.930FD PAG.104, 304  
FR024.930S PAG.104, 304  
FR024.930SD PAG.104, 304  
FR025.927F PAG.104, 304  
FR025.927FD PAG.104, 304  
FR025.930F PAG.104, 304  
FR025.930FD PAG.104, 304  
FR103.927S PAG.100  
FR103.930S PAG.100  
FR203.927S PAG.100  
FR203.930S PAG.100  
FW01 PAG.810  
FW02 PAG.809  
FW03 PAG.811  
FW04 PAG.809  
FW05 PAG.811  
FW06 PAG.809  
FW09 PAG.810
- G
- GU001 PAG.408  
GU002 PAG.408  
GU004.927F PAG.408  
GU004.927S PAG.408  
GU004.930F PAG.408  
GU004.930S PAG.408  
GU004.940F PAG.408  
GU004.940S PAG.408  
GU005.927F PAG.409  
GU005.927S PAG.409  
GU005.927W PAG.409  
GU005.930F PAG.409  
GU005.930S PAG.409  
GU005.930W PAG.409  
GU005.940F PAG.409  
GU005.940S PAG.409  
GU005.940W PAG.409  
GU006.927F PAG.409  
GU006.927S PAG.409  
GU006.927W PAG.409  
GU006.930F PAG.409  
GU006.930S PAG.409  
GU006.940F PAG.409  
GU006.940S PAG.409  
GU007 PAG.410
- H
- HS001 PAG.546  
HS001.930 PAG.546  
HS001.940 PAG.546  
HS002 PAG.546  
HS002.930 PAG.546  
HS002.940 PAG.546  
HS003 PAG.547  
HS003.930 PAG.547  
HS003.940 PAG.547  
HS004 PAG.547  
HS004.930 PAG.547  
HS004.940 PAG.547
- I
- IC0101.830 PAG.665, 744  
IC0101.840 PAG.665, 744  
IC0201.830 PAG.665, 744  
IC0201.840 PAG.665, 744  
IC0301.830 PAG.665, 744  
IC0301.840 PAG.665, 744  
IC0302.830 PAG.665, 744  
IC0302.840 PAG.665, 744  
IC0401.830 PAG.663, 745  
IC0401.840 PAG.663, 745  
IC0402\*\* PAG.663, 745  
IC0501.830 PAG.663, 745  
IC0501.840 PAG.663, 745  
IC0502\*\* PAG.663, 745  
IC0601.830D PAG.661  
IC0601.840D PAG.661  
IC0602.830 PAG.661  
IC0602.830D PAG.661  
IC0602.840 PAG.661  
IC0602.840D PAG.661  
IC0603.830 PAG.661  
IC0603.830D PAG.661  
IC0603.840 PAG.661  
IC0603.840D PAG.661  
IC0701.830D PAG.661  
IC0701.840D PAG.661  
IC0702.830 PAG.661  
IC0702.830D PAG.661  
IC0702.840 PAG.661  
IC0702.840D PAG.661  
IC0703.830 PAG.661  
IC0703.830D PAG.661  
IC0703.840 PAG.661  
IC0703.840D PAG.661  
IC1001.830 PAG.669, 746  
IC1001.840 PAG.669, 746  
IC1002.830 PAG.669, 746  
IC1002.840 PAG.669, 746  
IC1101.830 PAG.669, 746  
IC1101.840 PAG.669, 746  
IC1102.830 PAG.669, 746  
IC1102.840 PAG.669, 746  
IC1201 PAG.667  
IC1301 PAG.667  
IC1401 PAG.667  
IC1501 PAG.659  
IN001.930 PAG.518  
IN001.940 PAG.518  
IN01A PAG.512  
IN01AM PAG.514  
IN002.930 PAG.518  
IN002.940 PAG.518  
IN02A PAG.512  
IN02AM PAG.514  
IN003.930 PAG.519  
IN003.940 PAG.519  
IN03A PAG.513  
IN03AM PAG.515  
IN004.830 PAG.519  
IN004.840 PAG.519  
IN04A PAG.513  
IN04AM PAG.515  
IN11F PAG.518  
IN11FD PAG.518  
IN12F PAG.518  
IN12FD PAG.518  
IN13F PAG.519  
IN13FD PAG.519  
IN14F PAG.519  
IN14FD PAG.519  
IN45 PAG.554  
IN45.930S PAG.554
- IN45G9 PAG.554  
IN90 PAG.554  
IN90.930S PAG.554  
IN90GU PAG.554  
IN92 PAG.555  
IN92L1 PAG.555  
IN92L2 PAG.555  
IN93 PAG.555  
IN93L1 PAG.555  
IN93L2 PAG.555
- L
- L050A PAG.414, 454  
L050E PAG.414, 454  
L050F PAG.414, 454  
L050R PAG.414, 454  
L050S PAG.414, 454  
L074A PAG.454  
L074E PAG.454  
L074F PAG.454  
L074R PAG.454  
L074S PAG.454  
L085A.A PAG.396, 414, 484, 504, 590, 603, 615, 690  
L085E.A PAG.396, 414, 484, 504, 590, 603, 615, 690  
L085FA PAG.396, 414, 484, 504, 590, 603, 615, 690  
L085R.A PAG.396, 414, 484, 504, 590, 603, 615, 690  
L085S.A PAG.396, 414, 484, 504, 590, 603, 615, 690  
L105A PAG.484, 504  
L105E PAG.484, 504  
L105F PAG.484, 504  
L105R PAG.484, 504  
L105S PAG.484, 504  
L111A PAG.454  
L111E PAG.454  
L111F PAG.454  
L111R PAG.454  
L111S PAG.454  
LB001.830 PAG.43  
LB001.840 PAG.43  
LB002.830 PAG.43  
LB002.840 PAG.43  
LB003.830 PAG.43  
LB003.840 PAG.43  
LB011.830 PAG.45  
LB011.840 PAG.45  
LB012.830 PAG.45  
LB012.840 PAG.45  
LB013.830 PAG.45  
LB013.840 PAG.45  
LB021.830D PAG.43  
LB021.840D PAG.43  
LB022.830 PAG.43  
LB022.830D PAG.43  
LB022.840 PAG.43  
LB022.840D PAG.43  
LB023.830 PAG.43  
LB023.830D PAG.43  
LB023.840 PAG.43  
LB023.840D PAG.43  
LB031.830D PAG.45  
LB031.840D PAG.45  
LB032.830 PAG.45  
LB032.830D PAG.45
- LB032.840 PAG.45  
LB032.840D PAG.45  
LB033.830 PAG.45  
LB033.830D PAG.45  
LB033.840 PAG.45  
LB033.840D PAG.45  
LB041.830D PAG.42  
LB041.840D PAG.42  
LB042.830 PAG.42  
LB042.830D PAG.42  
LB042.840 PAG.42  
LB042.840D PAG.42  
LB043.830 PAG.42  
LB043.830D PAG.42  
LB043.840 PAG.42  
LB043.840D PAG.42  
LB101.927F PAG.47  
LB101.927W PAG.47  
LB101.930F PAG.47  
LB101.930W PAG.47  
LB101.940F PAG.47  
LB101.940W PAG.47  
LB201.830 PAG.46  
LB201.840 PAG.46  
LB202.830 PAG.46  
LB202.840 PAG.46  
LB203.830 PAG.46  
LB203.840 PAG.46  
LB210.830 PAG.44  
LB210.840 PAG.44  
LB301 PAG.48  
LB302 PAG.48  
LB303 PAG.48  
LB320 PAG.48  
LB321 PAG.48  
LB322 PAG.48  
LB323 PAG.48  
LB340 PAG.48  
LB341 PAG.48  
LB342 PAG.48  
LB403.2 PAG.51  
LB403.4 PAG.51  
LB405.2 PAG.51  
LB405.4 PAG.51  
LB407.2 PAG.51  
LB407.4 PAG.51  
LB409.2 PAG.51  
LB409.4 PAG.51  
LB420 PAG.51  
LB421 PAG.51  
LB422 PAG.49  
LB423.2 PAG.51  
LB423.4 PAG.51  
LB424 PAG.50  
LB425 PAG.50  
LB426 PAG.50  
LB427 PAG.50  
LB428 PAG.51  
LB431 PAG.49  
LB432 PAG.49  
LB433 PAG.49  
LB441 PAG.49  
LB442 PAG.49  
LB443 PAG.49  
LB444 PAG.49  
LB445 PAG.49  
LB446 PAG.49  
LB447 PAG.49
- LT14.14-24D PAG.294, 327  
LT14.28-54D PAG.294, 327  
LT14.35-49-80D PAG.294, 327  
LT15.14-24D PAG.294, 327  
LT15.21-39D PAG.294, 327  
LT15.28-54D PAG.294, 327  
LT15.35-80D PAG.294, 327  
LT16.14-24D PAG.294, 327  
LT16.21-39D PAG.294, 327  
LT16.28-54D PAG.294, 327  
LT16.35-49 PAG.294, 327  
LT16.35-49D PAG.294, 327  
LT16.80 PAG.294, 327  
LT20HS.misura\* PAG.550  
LT20.misura\* PAG.404  
LT20PL.500 PAG.405  
LT20PL.1000 PAG.405  
LT20PL.1500 PAG.405  
LT20PL.2000 PAG.405  
LT20PL.3000 PAG.405  
LT20PL.misura\* PAG.405  
LT21.14-24D PAG.328  
LT21.21-39D PAG.328  
LT21.28-54D PAG.328  
LT21.35-49-80D PAG.328  
LT25A1 PAG.275  
LT25A2 PAG.275  
LT25A3 PAG.275  
LT25A4 PAG.275  
LT25A10 PAG.275  
LT25A10D PAG.275  
LT25A11 PAG.275  
LT25A11D PAG.275  
LT25A13 PAG.275  
LT25A13D PAG.275  
LT25T.1000 PAG.207, 230, 296, 332  
LT25T.2000 PAG.207, 230, 296, 332  
LT25T.3000 PAG.207, 230, 296, 332  
LT26H1 PAG.321  
LT26H2 PAG.321  
LT26H3 PAG.321  
LT26H4 PAG.321  
LT26H6 PAG.321  
LT26H7 PAG.321  
LT26H9 PAG.321  
LT40.14-24D PAG.206, 229  
LT42.21-39D PAG.206, 229  
LT44.28-54D PAG.206, 229  
LT46.35-80D PAG.206, 229  
LT239P.100 PAG.208, 231, 354  
LT239P.2000 PAG.208, 231, 354  
LT239P.3000PAG.208, 231, 354  
LT239P.misura\*PAG.208, 231  
LT239X.1000 PAG.208, 231  
LT239X.2000 PAG.208, 231  
LT239X.3000 PAG.208, 231  
LT239X.misura\* PAG.208, 231  
LT243.90 PAG.202  
LT243.1000 PAG.202  
LT243.2000 PAG.202  
LT243.3000 PAG.202  
LT243.misura\* PAG.202  
LT243.PS PAG.202  
LT243.T PAG.202  
LT243.X PAG.202  
LT247.90 PAG.200

LT247.1000 PAG.200	LT1231 PAG.	LT1711 PAG.714	LT2073D PAG.411	LT2412.4000 PAG.291	LT2520.2000 PAG.324	LT2561XD PAG.271
LT247.2000 PAG.200	LT1232 PAG.	LT1712 PAG.714	LT2075 PAG.411	LT2426 PAG.200	LT2520.3000 PAG.324	LT2566 PAG.269
LT247.3000 PAG.200	LT1233 PAG.537	LT1713 PAG.714	LT2075D PAG.411	LT2440.14-24 PAG.206 229	LT2520.misura* PAG.324	LT2566K PAG.272
LT247.misura* PAG.200	LT1234 PAG.537	LT1715.1 PAG.714	LT2077 PAG.411	LT2442.21-39 PAG.206 229	LT2520.T PAG.324	LT2566X PAG.271
LT247.PS PAG.200	LT1250.927F PAG.530	LT1715.2 PAG.714	LT2077D PAG.411	LT2444.28-54 PAG.206 229	LT2520.X PAG.324	LT2568 PAG.269
LT247.T PAG.200	LT1250.927S PAG.530	LT1716 PAG.715	LT2078 PAG.411	LT2446.35-49.80 PAG.206 229	LT2521.14-24 PAG.328	LT2568K PAG.272
LT247.X PAG.200	LT1250.930F PAG.530	LT1717 PAG.715	LT2078D PAG.411	LT2470 PAG.200	LT2521.21-39 PAG.328	LT2568X PAG.271
LT248 PAG.201	LT1250.930S PAG.530	LT1800.927F PAG.770	LT2080 PAG.413	LT2480 PAG.212	LT2521.28-54 PAG.328	LT2573 PAG.269
LT248.90 PAG.201	LT1250.940F PAG.530	LT1800.927S PAG.770	LT2080.68 PAG.413	LT2480.1 PAG.191, 352	LT2521.35-49.80 PAG.328	LT2573D PAG.269
LT248.1000 PAG.201	LT1250.940S PAG.530	LT1800.930F PAG.770	LT2080.68L PAG.413	LT2481 PAG.105, 353	LT2522 PAG.324	LT2573K PAG.272
LT248.2000 PAG.201	LT1254.927F PAG.530	LT1800.930S PAG.770	LT2080L PAG.413	LT2482 PAG.213, 353	LT2523 PAG.331	LT2573KD PAG.272
LT248.3000 PAG.201	LT1254.927S PAG.530	LT1800.940F PAG.770	LT2081 PAG.413	LT2484 PAG.299, 330	LT2523.90 PAG.331	LT2573X PAG.271
LT248.misura* PAG.201	LT1254.930F PAG.530	LT1800.940S PAG.770	LT2081.68 PAG.413	LT2485 PAG.299, 330	LT2524.90 PAG.287	LT2573XD PAG.271
LT248.PS PAG.201	LT1254.930S PAG.530	LT1809 PAG.770	LT2081.68L PAG.413	LT2486 PAG.299, 330	LT2524.1000 PAG.287	LT2591 PAG.258
LT248S PAG.201	LT1254.940F PAG.530	LT1981 PAG.562	LT2081L PAG.413	LT2506 PAG.295, 329	LT2524.2000 PAG.287	LT2591X PAG.260
LT248.T PAG.201	LT1254.940S PAG.530	LT1981BC PAG.562	LT2082 PAG.413	LT2506.927F PAG.295, 329	LT2524.3000 PAG.287	LT2592 PAG.258
LT248.X PAG.201	LT1258.927F PAG.531	LT1981BCIP PAG.792	LT2082.68 PAG.413	LT2506.927W PAG.295, 329	LT2524.misura* PAG.287	LT2592X PAG.260
LT1160 PAG.423	LT1258.927S PAG.531	LT1982 PAG.562	LT2082.68L PAG.413	LT2506.930F PAG.295, 329	LT2524.PS PAG.287	LT2593 PAG.258
LT1160.927F PAG.423	LT1258.930F PAG.531	LT1982BC PAG.562	LT2082L PAG.413	LT2506.930W PAG.295, 329	LT2524.T PAG.287	LT2593X PAG.260
LT1160.927S PAG.423	LT1258.930S PAG.531	LT1982BCIP PAG.792	LT2083 PAG.413	LT2506P1000 PAG.299,330, 358	LT2524.X PAG.287	LT2630K PAG.318
LT1160.930F PAG.423	LT1258.940F PAG.531	LT1983 PAG.562	LT2083.68 PAG.413	LT2506P2000 PAG.299, 330, 358	LT2525 PAG.287	LT2630KD PAG.318
LT1160.930S PAG.423	LT1258.940S PAG.531	LT1983BC PAG.562	LT2083.68L PAG.413	LT2506P3000 PAG.299, 330, 358	LT2526 PAG.287	LT2632K PAG.318
LT1160.940F PAG.423	LT1262.927F PAG.531	LT1983BCIP PAG.792	LT2083L PAG.413	LT2506P3000 PAG.299, 330, 358	LT2530 PAG.258	LT2632KD PAG.318
LT1160.940S PAG.423	LT1262.927S PAG.531	LT1990 PAG.563, 793	LT2190 PAG.407	LT2506P3000 PAG.299, 330, 358	LT2530B PAG.280, 642	LT2634K PAG.318
LT1161 PAG.423	LT1262.930F PAG.531	LT1991 PAG.563, 793	LT2190.68 PAG.407	LT2506P3000 PAG.299, 330, 358	LT2530BK PAG.281, 643	LT2634KD PAG.318
LT1161.930F PAG.423	LT1262.930S PAG.531	LT1992 PAG.563, 793	LT2310.90 PAG.226	LT2506P3000 PAG.299, 330, 358	LT2530BX PAG.281, 643	LT2637K PAG.318
LT1161.930W PAG.423	LT1262.940F PAG.531	LT2010 PAG.406	LT2310.1000 PAG.226	LT2506P3000 PAG.299, 330, 358	LT2530X PAG.261	LT2637KD PAG.318
LT1161.940F PAG.423	LT1262.940S PAG.531	LT2010.68 PAG.406	LT2310.2000 PAG.226	LT2506X.1000 PAG.299,330	LT2530X PAG.260	LT2642 PAG.316
LT1161.940W PAG.423	LT1266.927F PAG.534	LT2010.68PL PAG.406	LT2310.3000 PAG.226	LT2506X.2000 PAG.299,330	LT2532 PAG.258	LT2642D PAG.316
LT1163 PAG.423	LT1266.927S PAG.534	LT2010HS PAG.550	LT2310.misura* PAG.226	LT2506X.3000 PAG.299,330	LT2532B PAG.280, 642	LT2642X PAG.317
LT1163.930S PAG.423	LT1266.930F PAG.534	LT2010HS.68 PAG.550	LT2310.T PAG.226	LT2506X.misura* PAG.299,330	LT2532BK PAG.281, 643	LT2642XD PAG.317
LT1164 PAG.422	LT1266.930S PAG.534	LT2010PL PAG.406	LT2310.X PAG.226	LT2507 PAG.295, 329	LT2532BX PAG.281, 643	LT2644 PAG.316
LT1164.927F PAG.422	LT1266.940F PAG.534	LT2011 PAG.404	LT2311.1000 PAG.227	LT2507 PAG.295, 329	LT2532K PAG.261	LT2644D PAG.316
LT1164.927S PAG.422	LT1266.940S PAG.534	LT2011HS PAG.551	LT2311.2000 PAG.227	LT2507927F PAG.295, 329	LT2532X PAG.260	LT2644X PAG.317
LT1164.930F PAG.422	LT1270.927F PAG.534	LT2011PL PAG.405	LT2311.3000 PAG.227	LT2507927W PAG.295,329	LT2534 PAG.258	LT2644XD PAG.317
LT1164.930S PAG.422	LT1270.927S PAG.534	LT2012 PAG.404	LT2311.misura* PAG.227	LT2507930F PAG.295, 329	LT2534B PAG.280, 642	LT2649 PAG.316
LT1164.940F PAG.422	LT1270.930F PAG.534	LT2012.68PL PAG.405	LT2397 PAG.208, 231	LT2507930W PAG.295,329	LT2534BK PAG.281, 643	LT2649D PAG.316
LT1164.940S PAG.422	LT1270.930S PAG.534	LT2012HS.68 PAG.404,551	LT2398 PAG.208, 231	LT2508 PAG.295, 329	LT2534BX PAG.281, 643	LT2649X PAG.317
LT1165 PAG.422	LT1270.940F PAG.534	LT2012PL PAG.405	LT2399 PAG.208, 231	LT2508.927F PAG.295,329	LT2534K PAG.261	LT2649XD PAG.317
LT1165.930F PAG.422	LT1270.940S PAG.534	LT2013 PAG.370, 406, 551	LT2400 PAG.208, 231	LT2508.927W PAG.295,329	LT2534X PAG.260	LT2660 PAG.306, 693, 697
LT1165.930W PAG.422	LT1274.927F PAG.535	LT2014 PAG.406, 551	LT2403 PAG.202	LT2508.930F PAG.295, 329	LT2537 PAG.258	LT2660.930FPAG.306, 693, 697
LT1165.940F PAG.422	LT1274.927S PAG.535	LT2016 PAG.404	LT2404 PAG.226	PAG.295, 329	LT2537K PAG.261	LT2660.930W PAG.306, 693, 697
LT1165.940W PAG.422	LT1274.930F PAG.535	LT2016HS PAG.550	LT2406 PAG.209	LT2511 PAG.290	LT2537X PAG.260	LT2660.940F PAG.306, 693, 697
LT1167 PAG.422	LT1274.930S PAG.535	LT2017 PAG.404	LT2406.H PAG.231	LT2512 PAG.298	LT2542 PAG.258	LT2660.940W PAG.306, 693, 697
LT1167.930S PAG.422	LT1274.940F PAG.535	LT2017HS PAG.550	LT2406.H90 PAG.231	LT2512.90 PAG.298	LT2542B PAG.280, 642	LT2660.940W PAG.306, 693, 697
LT1191 PAG.536	LT1274.940S PAG.535	LT2018 PAG.404	LT2410 PAG.203	LT2512.90P PAG.298	LT2542BK PAG.281, 643	LT2660.940W PAG.306, 693, 697
LT1192 PAG.536	LT1279.927F PAG.535	LT2018HS PAG.550	LT2410.4000 PAG.203	LT2513.90 PAG.290	LT2542BX PAG.281, 643	LT2661.930F PAG.306, 693, 697
LT1193 PAG.536	LT1279.927S PAG.535	LT2019 PAG.404	LT2410H PAG.227	LT2513.1000 PAG.290	LT2542K PAG.261	LT2661.930F PAG.306, 693, 697
LT1194 PAG.536	LT1279.930F PAG.535	LT2019HS PAG.550	LT2410H.4000 PAG.227	LT2513.2000 PAG.290	LT2542X PAG.260	LT2661.930F PAG.306, 693, 697
LT1195 PAG.	LT1279.930S PAG.535	LT2020 PAG.404	LT2411 PAG.203, 227, 291, 325	LT2513.3000 PAG.290	LT2544 PAG.258	LT2661.930F PAG.306, 693, 697
LT1196 PAG.	LT1279.940F PAG.535	LT2020HS PAG.550	LT2411.4000 PAG.203, 227, 291, 325	LT2513.misura* PAG.290	LT2544B PAG.280, 642	LT2661.930W PAG.306, 693, 697
LT1197 PAG.537	LT1279.940S PAG.535	LT2031 PAG.407	LT2412.5 PAG.203, 227, 291, 325	LT2513.PS PAG.290	LT2544BK PAG.281, 643	LT2661.930W PAG.306, 693, 697
LT1198 PAG.537	LT1401 PAG.630	LT2031.68 PAG.407	LT2412.5 PAG.203, 227, 291, 325	LT2513.T PAG.290	LT2544BX PAG.281, 643	LT2661.940F PAG.306, 693, 697
LT1201 PAG.534	LT1405 PAG.630	LT2032 PAG.407	LT2412.7 PAG.203, 227, 291, 325	LT2513.X PAG.290	LT2544K PAG.261	LT2661.940W PAG.306, 693, 697
LT1202 PAG.534	LT1411 PAG.630	LT2032.68 PAG.407	LT2412.7 PAG.203, 227, 291, 325	LT2514.14-24 PAG.294, 327	LT2544X PAG.260	LT2662 PAG.306, 693, 697
LT1204 PAG.530	LT1456 PAG.631	LT2033 PAG.407	LT2412.5 PAG.203, 227, 291, 325	LT2514.21-39 PAG.294, 327	LT2549 PAG.258	LT2662.930F PAG.306, 693, 697
LT1205 PAG.530	LT1457 PAG.631	LT2033.68 PAG.407	LT2412.5.4000 PAG.203, 227, 291, 325	LT2514.28-54 PAG.294, 327	LT2549K PAG.261	LT2662.930F PAG.306, 693, 697
LT1207 PAG.534	LT1692 PAG.570	LT2034 PAG.407	LT2412.5.4000 PAG.203, 227, 291, 325	LT2514.35-49.80 PAG.294, 327	LT2549X PAG.260	LT2662.930W PAG.306, 693, 697
LT1208 PAG.534	LT1693 PAG.570	LT2034.68 PAG.407	LT2412.7.4000 PAG.203, 227, 291, 325	LT2515.14-24 PAG.294, 327	LT2556 PAG.269	LT2662.940F PAG.306, 693, 697
LT1211 PAG.530	LT1700 PAG.712	LT2035 PAG.407	LT2412.7 PAG.203, 227, 291, 325	LT2515.21-39 PAG.294, 327	LT2556K PAG.272	LT2662.940W PAG.306, 693, 697
LT1212 PAG.530	LT1701 PAG.712	LT2035.68 PAG.407	LT2412.9 PAG.203, 227, 291, 325	LT2515.2854 PAG.294, 327	LT2556X PAG.271	LT2700.90 PAG.288
LT1215 PAG.535	LT1702 PAG.713	LT2036 PAG.407	LT2412.9.4000 PAG.203, 227, 291, 325	LT2515.35-49.80 PAG.294, 327	LT2558 PAG.269	LT2700.1000 PAG.288
LT1216 PAG.535	LT1703 PAG.713	LT2036.68 PAG.407	LT2412.9.4000 PAG.203, 227, 291, 325	LT2516.14-24 PAG.294, 327	LT2558K PAG.272	LT2700.2000 PAG.288
LT1219 PAG.531	LT1704 PAG.713	LT2038 PAG.407	LT2412.9.4000 PAG.203, 227, 291, 325	LT2516.21-39 PAG.294, 327	LT2558X PAG.271	LT2700.3000 PAG.288
LT1220 PAG.531	LT1705 PAG.713	LT2038.68 PAG.407	LT2412.9.4000 PAG.203, 227, 291, 325	LT2516.28-54 PAG.294, 327	LT2561 PAG.269	LT2700.misura* PAG.288
LT1223 PAG.535	LT1706 PAG.713	LT2071 PAG.410	LT2412.9.4000 PAG.203, 227, 291, 325	LT2519 PAG.325	LT2561D PAG.269	LT2700.PS PAG.288
LT1224 PAG.535	LT1707 PAG.713	LT2071 PAG.411	LT2412.9.4000 PAG.203, 227, 291, 325	LT2519.4 PAG.325	LT2561K PAG.272	LT2700.T PAG.288
LT1227 PAG.531	LT1709 PAG.714	LT2071D PAG.411	LT2412.9.4000 PAG.203, 227, 291, 325	LT2520.90 PAG.324	LT2561KD PAG.272	LT2700.X PAG.288
LT1228 PAG.531	LT1710 PAG.714	LT2073 PAG.411		LT2520.1000 PAG.324	LT2561X PAG.271	LT2730 PAG.242



LT2730K PAG.245	LT2846K PAG.195	LT9062C PAG.	LTA546BK PAG.281, 643	LTA648D PAG.316	LTA935D PAG.220	LTC6H5D PAG.321
LT2730X PAG.244	LT2846X PAG.194	LT9883.14.830 PAG.151	LTA546BX PAG.281, 643	LTA648X PAG.317	LTA935K PAG.221	LTC6H7 PAG.321
LT2732 PAG.242	LT2848 PAG.193	LT9883.14.840 PAG.151	LTA546K PAG.261	LTA648XD PAG.317	LTA935KD PAG.221	LTC6H7D PAG.321
LT2732K PAG.245	LT2848K PAG.195	LT9883.21.830 PAG.151	LTA546X PAG.260	LTA650 PAG.316	LTA935X PAG.221	LTC6H8 PAG.321
LT2732X PAG.244	LT2848X PAG.194	LT9883.24.830 PAG.151	LTA548 PAG.258	LTA650D PAG.316	LTA935XD PAG.221	LTC6H8D PAG.321
LT2734 PAG.242	LT2850 PAG.193	LT9883.24.840 PAG.151	LTA548K PAG.261	LTA650X PAG.317	LTA938 PAG.220	LTC6H9 PAG.321
LT2734K PAG.245	LT2850D PAG.193	LT9883.28.830 PAG.151	LTA548X PAG.260	LTA650XD PAG.317	LTA938D PAG.220	LTC6H9D PAG.321
LT2734X PAG.244	LT2850K PAG.195	LT9883.28.840 PAG.151	LTA550 PAG.258	LTA651 PAG.316	LTA938K PAG.221	LTC030 PAG.178
LT2737 PAG.242	LT2850KD PAG.195	LT9883.35.830 PAG.151	LTA550K PAG.261	LTA651X PAG.317	LTA938KD PAG.221	LTC030D PAG.178
LT2737K PAG.245	LT2850X PAG.194	LT9883.35.840 PAG.151	LTA550X PAG.260	LTA736 PAG.242	LTA938X PAG.221	LTC030X PAG.179
LT2737X PAG.244	LT2850XD PAG.194	LT9883.39.830 PAG.151	LTA551 PAG.258	LTA736K PAG.245	LTA938XD PAG.221	LTC030XD PAG.179
LT2742 PAG.242	LT2853 PAG.193	LT9883.39.840 PAG.151	LTA551K PAG.261	LTA736X PAG.244	LTA939 PAG.220	LTC031 PAG.178
LT2742K PAG.245	LT2853D PAG.193	LT9883.49.830 PAG.151	LTA551X PAG.260	LTA738 PAG.242	LTA939K PAG.221	LTC031D PAG.178
LT2742X PAG.244	LT2853K PAG.195	LT9883.49.840 PAG.151	LTA560 PAG.269	LTA738K PAG.245	LTA939X PAG.221	LTC031X PAG.179
LT2744 PAG.242	LT2853KD PAG.195	LT9883.54.830 PAG.151	LTA560D PAG.269	LTA738X PAG.244	LTB5A12 PAG.275	LTC031XD PAG.179
LT2744K PAG.245	LT2853X PAG.194	LT9883.54.840 PAG.151	LTA560K PAG.272	LTA739 PAG.242	LTB6H5 PAG.321	LTC032 PAG.178
LT2744X PAG.244	LT2853XD PAG.194	LT9883.80.830 PAG.151	LTA560KD PAG.272	LTA739K PAG.245	LTB6H8 PAG.321	LTC032D PAG.178
LT2749 PAG.242	LT2881 PAG.288	LT9883.80.840 PAG.151	LTA560X PAG.271	LTA739X PAG.244	LTB43.1000 PAG.203	LTC032X PAG.179
LT2749K PAG.245	LT2882 PAG.289	LT9883.80.840 PAG.151	LTA560XD PAG.271	LTA745 PAG.242	LTB43.2000 PAG.203	LTC032XD PAG.179
LT2749X PAG.244	LT2882.90 PAG.289	LT9883.85.840 PAG.151	LTA562 PAG.269	LTA745K PAG.245	LTB43.3000 PAG.203	LTC033 PAG.178
LT2760 PAG.249	LT2884.1000 PAG.289	LT9883.89.830 PAG.151	LTA562D PAG.269	LTA745X PAG.244	LTB43.misura* PAG.203	LTC033D PAG.178
LT2760X PAG.251	LT2884.2000 PAG.289	LT9883.89.840 PAG.151	LTA562X PAG.272	LTA746 PAG.242	LTB513.1000 PAG.291	LTC033X PAG.179
LT2761 PAG.249	LT2884.3000 PAG.289	LT9883.89.840 PAG.151	LTA562KD PAG.272	LTA746K PAG.245	LTB513.2000 PAG.291	LTC033XD PAG.179
LT2761X PAG.251	LT2884.misura PAG.289	LT9883.99.830 PAG.151	LTA562X PAG.271	LTA746X PAG.244	LTB513.3000 PAG.291	LTC034 PAG.178
LT2762 PAG.249	LT2885.1000 PAG.289	LT9883.99.840 PAG.151	LTA562XD PAG.271	LTA748 PAG.242	LTB513.misura* PAG.291	LTC034D PAG.178
LT2762X PAG.251	LT2885.2000 PAG.289	LT9883.99.840 PAG.151	LTA563 PAG.269	LTA748K PAG.245	LTB546B PAG.280, 642	LTC034X PAG.179
LT2763 PAG.249	LT2885.3000 PAG.289	LT9883.99.840 PAG.151	LTA563D PAG.269	LTA748X PAG.244	LTB546BK PAG.281, 643	LTC034XD PAG.179
LT2763D PAG.249	LT2885.misura PAG.289	LT9883.99.840 PAG.151	LTA563X PAG.272	LTA750 PAG.242	LTB546BX PAG.281, 643	LTC035 PAG.178
LT2763X PAG.251	LT2886 PAG.288	LT9883.99.840 PAG.151	LTA563KD PAG.272	LTA750K PAG.245	LTB765 PAG.249	LTC035D PAG.178
LT2763XD PAG.251	LT2890 PAG.302, 356	LT9883.99.840 PAG.151	LTA563X PAG.271	LTA750X PAG.244	LTB765D PAG.249	LTC035X PAG.179
LT2764 PAG.249	LT2891 PAG.303, 357	LT9883.99.840 PAG.151	LTA563XD PAG.271	LTA751 PAG.242	LTB765X PAG.251	LTC035XD PAG.179
LT2764D PAG.249	LT2892 PAG.302, 357	LT9883.99.840 PAG.151	LTA569 PAG.269	LTA751K PAG.245	LTB765XD PAG.251	LTC036 PAG.178
LT2764X PAG.251	LT2930 PAG.220	LT9883.99.840 PAG.151	LTA569D PAG.269	LTA751X PAG.244	LTB770 PAG.249	LTC036D PAG.178
LT2764XD PAG.251	LT2930D PAG.220	LT9883.99.840 PAG.151	LTA569K PAG.272	LTA765 PAG.249	LTB770X PAG.251	LTC036X PAG.179
LT2768 PAG.249	LT2930K PAG.221	LT9883.99.840 PAG.151	LTA569KD PAG.272	LTA765D PAG.249	LTB825 PAG.195	LTC036XD PAG.179
LT2768X PAG.251	LT2930KD PAG.221	LT9883.99.840 PAG.151	LTA569X PAG.271	LTA765X PAG.251	LTC1.1000 PAG.206, 229, 329	LTC037 PAG.178
LT2769 PAG.249	LT2930X PAG.221	LT9883.99.840 PAG.151	LTA569XD PAG.271	LTA765XD PAG.251	LTC1.2000 PAG.206, 229, 329	LTC037D PAG.178
LT2769X PAG.251	LT2930XD PAG.221	LT9883.99.840 PAG.151	LTA570 PAG.269	LTA770 PAG.249	LTC1.3000 PAG.206, 229, 329	LTC037X PAG.179
LT2810 PAG.223	LT2932 PAG.220	LT9883.99.840 PAG.151	LTA570K PAG.272	LTA770X PAG.251	LTC1.misura PAG.229	LTC037XD PAG.179
LT2811 PAG.223	LT2932D PAG.220	LT9883.99.840 PAG.151	LTA570X PAG.271	LTA821 PAG.195	LTC1.misura* PAG.206, 329	LTC038 PAG.178
LT2812 PAG.223	LT2932K PAG.221	LT9883.99.840 PAG.151	LTA572 PAG.269	LTA825 PAG.195	LTC2.1000 PAG.295, 329	LTC038D PAG.178
LT2813 PAG.223	LT2932KD PAG.221	LT9883.99.840 PAG.151	LTA572D PAG.269	LTA837 PAG.189	LTC2.2000 PAG.295, 329	LTC038X PAG.179
LT2814 PAG.223	LT2932X PAG.221	LT9883.99.840 PAG.151	LTA572K PAG.272	LTA837K PAG.191	LTC2.3000 PAG.295, 329	LTC038XD PAG.179
LT2816 PAG.223	LT2932XD PAG.221	LT9883.99.840 PAG.151	LTA572KD PAG.272	LTA837X PAG.190	LTC2.misura* PAG.295, 329	LTC044 PAG.184
LT2817 PAG.223	LT2934 PAG.220	LT9883.99.840 PAG.151	LTA572X PAG.271	LTA840 PAG.189	LTC5A1 PAG.275	LTC044D PAG.184
LT2820 PAG.195	LT2934D PAG.220	LT9883.99.840 PAG.151	LTA572XD PAG.271	LTA840K PAG.191	LTC5A1D PAG.275	LTC044X PAG.185
LT2821 PAG.195	LT2934K PAG.221	LT9883.99.840 PAG.151	LTA574 PAG.269	LTA840X PAG.190	LTC5A2 PAG.275	LTC044XD PAG.185
LT2822 PAG.195	LT2934KD PAG.221	LT9883.99.840 PAG.151	LTA574D PAG.269	LTA841 PAG.189	LTC5A2D PAG.275	LTC045 PAG.184
LT2823 PAG.195	LT2934X PAG.221	LT9883.99.840 PAG.151	LTA574K PAG.272	LTA841K PAG.191	LTC5A3 PAG.275	LTC045D PAG.184
LT2824 PAG.195	LT2934XD PAG.221	LT9883.99.840 PAG.151	LTA574KD PAG.272	LTA841X PAG.190	LTC5A3D PAG.275	LTC045X PAG.185
LT2830 PAG.189	LT2937 PAG.220	LT9883.99.840 PAG.151	LTA574X PAG.271	LTA852 PAG.193	LTC5A4 PAG.275	LTC045XD PAG.185
LT2830K PAG.191	LT2937D PAG.220	LT9883.99.840 PAG.151	LTA574XD PAG.271	LTA852D PAG.193	LTC5A4D PAG.275	LTC046 PAG.184
LT2830X PAG.190	LT2937K PAG.221	LT9883.99.840 PAG.151	LTA575 PAG.269	LTA852K PAG.195	LTC5A5 PAG.275	LTC046D PAG.184
LT2832 PAG.189	LT2937KD PAG.221	LT9883.99.840 PAG.151	LTA575K PAG.272	LTA852KD PAG.195	LTC5A5D PAG.275	LTC046X PAG.185
LT2832K PAG.191	LT2937X PAG.221	LT9883.99.840 PAG.151	LTA575X PAG.271	LTA852X PAG.194	LTC5A6 PAG.275	LTC046XD PAG.185
LT2832X PAG.190	LT2937XD PAG.221	LT9883.99.840 PAG.151	LTA594 PAG.258	LTA852XD PAG.194	LTC5A6D PAG.275	LTC047 PAG.184
LT2834 PAG.189	LT3030 PAG.178	LT9883.99.840 PAG.151	LTA594X PAG.260	LTA854 PAG.193	LTC5A7 PAG.275	LTC047D PAG.184
LT2834K PAG.191	LT3030K PAG.180	LT9883.99.840 PAG.151	LTA636K PAG.318	LTA854D PAG.193	LTC5A7D PAG.275	LTC047X PAG.185
LT2834X PAG.190	LT3030X PAG.179	LT9883.99.840 PAG.151	LTA636KD PAG.318	LTA854K PAG.195	LTC5A8 PAG.275	LTC047XD PAG.185
LT2836 PAG.189	LT3032 PAG.178	LT9883.99.840 PAG.151	LTA638K PAG.318	LTA854KD PAG.195	LTC5A8D PAG.275	LTC048 PAG.184
LT2836K PAG.191	LT3032K PAG.180	LT9883.99.840 PAG.151	LTA638KD PAG.318	LTA854X PAG.194	LTC6H1 PAG.321	LTC048D PAG.184
LT2836X PAG.190	LT3032X PAG.179	LT9883.99.840 PAG.151	LTA639K PAG.318	LTA854XD PAG.194	LTC6H1D PAG.321	LTC048X PAG.185
LT2839 PAG.189	LT3034 PAG.178	LT9883.99.840 PAG.151	LTA645 PAG.316	LTA855 PAG.193	LTC6H2 PAG.321	LTC048XD PAG.185
LT2839K PAG.191	LT3034K PAG.180	LT9883.99.840 PAG.151	LTA645D PAG.316	LTA855D PAG.193	LTC6H2D PAG.321	LTC049 PAG.184
LT2839X PAG.190	LT3034X PAG.179	LT9883.99.840 PAG.151	LTA645X PAG.317	LTA855K PAG.195	LTC6H3 PAG.321	LTC049D PAG.184
LT2844 PAG.193	LT3036 PAG.178	LT9883.99.840 PAG.151	LTA645XD PAG.317	LTA855KD PAG.195	LTC6H3D PAG.321	LTC049X PAG.185
LT2844K PAG.195	LT9061 PAG.	LT9883.99.840 PAG.151	LTA646 PAG.316	LTA855X PAG.194	LTC6H4 PAG.321	LTC049XD PAG.185
LT2844X PAG.194	LT9061C PAG.	LT9883.99.840 PAG.151	LTA646X PAG.317	LTA855XD PAG.194	LTC6H4D PAG.321	LTC050 PAG.184
LT2846 PAG.193	LT9062 PAG.	LT9883.99.840 PAG.151	LTA648 PAG.316	LTA935 PAG.220	LTC6H5 PAG.321	LTC050D PAG.184

LTC050X PAG.185	LTC533AD PAG.256	LTC556AX PAG.270	LTC636X PAG.317	LTC735AX PAG.243	LTC764XD PAG.250	LTC834D PAG.189
LTC050XD PAG.185	LTC533AIP PAG.257, 774	LTC556AXD PAG.270	LTC636XD PAG.317	LTC735AXD PAG.243	LTC765 PAG.248	LTC834X PAG.190
LTC051 PAG.184	LTC533AIPD PAG.257, 774	LTC556D PAG.268	LTC637 PAG.316	LTC735D PAG.240	LTC765A PAG.248	LTC834XD PAG.190
LTC051D PAG.184	LTC533AX PAG.259	LTC556X PAG.270	LTC637D PAG.316	LTC735IP PAG.241, 773	LTC765AD PAG.248	LTC835 PAG.189
LTC051X PAG.185	LTC533AXD PAG.259	LTC556XD PAG.270	LTC637X PAG.317	LTC735IPD PAG.241, 773	LTC765AX PAG.250	LTC835D PAG.189
LTC051XD PAG.185	LTC533D PAG.256	LTC557 PAG.268	LTC637XD PAG.317	LTC735X PAG.243	LTC765AXD PAG.250	LTC835X PAG.190
LTC052 PAG.184	LTC533IP PAG.257, 774	LTC557A PAG.268	LTC730 PAG.240	LTC735XD PAG.243	LTC765D PAG.248	LTC835XD PAG.190
LTC052D PAG.184	LTC533IPD PAG.257, 774	LTC557AD PAG.268	LTC730A PAG.240	LTC736 PAG.240	LTC765X PAG.250	LTC836 PAG.189
LTC052X PAG.185	LTC533X PAG.259	LTC557AX PAG.270	LTC730AD PAG.240	LTC736A PAG.240	LTC765XD PAG.250	LTC836D PAG.189
LTC052XD PAG.185	LTC533XD PAG.259	LTC557AXD PAG.270	LTC730AIP PAG.241, 773	LTC736AD PAG.240	LTC766 PAG.248	LTC836X PAG.190
LTC53 PAG.259	LTC534 PAG.256	LTC557D PAG.268	LTC730AIPD PAG.241, 773	LTC736AIP PAG.241, 773	LTC766A PAG.248	LTC836XD PAG.190
LTC53D PAG.259	LTC534A PAG.256	LTC557X PAG.270	LTC730AX PAG.243	LTC736AIPD PAG.241, 773	LTC766AD PAG.248	LTC837 PAG.189
LTC56 PAG.270	LTC534AD PAG.256	LTC557XD PAG.270	LTC730AXD PAG.243	LTC736AX PAG.243	LTC766AX PAG.250	LTC837D PAG.189
LTC56 D PAG.270	LTC534AIP PAG.257, 774	LTC558 PAG.268	LTC730D PAG.240	LTC736AXD PAG.243	LTC766AXD PAG.250	LTC837X PAG.190
LTC73 PAG.243	LTC534AIPD PAG.257, 774	LTC558A PAG.268	LTC730IP PAG.241, 773	LTC736D PAG.240	LTC766D PAG.248	LTC837XD PAG.190
LTC73D PAG.243	LTC534AX PAG.259	LTC558AD PAG.268	LTC730IPD PAG.241, 773	LTC736E PAG.241, 773	LTC766X PAG.250	LTC838 PAG.189
LTC76 PAG.250	LTC534AXD PAG.259	LTC558AX PAG.270	LTC730X PAG.243	LTC736IPD PAG.241, 773	LTC766XD PAG.250	LTC838D PAG.189
LTC76D PAG.250	LTC534D PAG.256	LTC558AXD PAG.270	LTC730XD PAG.243	LTC736X PAG.243	LTC767 PAG.248	LTC838X PAG.190
LTC530 PAG.256	LTC534IP PAG.257, 774	LTC558D PAG.268	LTC731 PAG.240	LTC736XD PAG.243	LTC767A PAG.248	LTC838XD PAG.190
LTC530A PAG.256	LTC534IPD PAG.257, 774	LTC558X PAG.270	LTC731A PAG.240	LTC737 PAG.240	LTC767AD PAG.248	LTC844 PAG.193
LTC530AB PAG.280, 642	LTC534X PAG.259	LTC558XD PAG.270	LTC731AD PAG.240	LTC737A PAG.240	LTC767AX PAG.250	LTC844D PAG.193
LTC530ABX PAG.281, 643	LTC535 PAG.259	LTC559 PAG.268	LTC731AIP PAG.241, 773	LTC737AD PAG.240	LTC767AXD PAG.250	LTC844X PAG.194
LTC530AD PAG.256	LTC535A PAG.256	LTC559A PAG.268	LTC731AIPD PAG.241, 773	LTC737AIP PAG.241, 773	LTC767D PAG.248	LTC844XD PAG.194
LTC530AIP PAG.257, 774	LTC535AIP PAG.257, 774	LTC559AD PAG.268	LTC731AX PAG.243	LTC737AIPD PAG.241, 773	LTC767X PAG.250	LTC845 PAG.193
LTC530AIPD PAG.257, 774	LTC535AIPD PAG.257, 774	LTC559AX PAG.270	LTC731AXD PAG.243	773	LTC767XD PAG.250	LTC845D PAG.193
LTC530AX PAG.259	LTC535AIP PAG.257, 774	LTC559AXD PAG.270	LTC731D PAG.240	LTC737AX PAG.243	LTC809 PAG.223	LTC845X PAG.194
LTC530AXD PAG.259	LTC535AIPD PAG.257, 774	LTC559D PAG.268	LTC731IP PAG.241, 773	LTC737AXD PAG.243	LTC809D PAG.223	LTC845XD PAG.194
LTC530B PAG.280, 642	LTC535AX PAG.259	LTC559X PAG.270	LTC731IPD PAG.241, 773	LTC737D PAG.240	LTC810 PAG.223	LTC846 PAG.193
LTC530BX PAG.281, 643	LTC535AXD PAG.259	LTC559XD PAG.270	LTC732 PAG.240	LTC737IP PAG.241, 773	LTC810D PAG.223	LTC846D PAG.193
LTC530BXD PAG.281, 643	LTC535D PAG.256	LTC560 PAG.268	LTC732A PAG.240	LTC737IPD PAG.241, 773	LTC811 PAG.223	LTC846X PAG.194
LTC530XD PAG.256	LTC535IP PAG.257, 774	LTC560A PAG.268	LTC732AD PAG.240	LTC737X PAG.243	LTC811D PAG.223	LTC846XD PAG.194
LTC530IP PAG.257, 774	LTC535IPD PAG.257, 774	LTC560AD PAG.268	LTC732AIP PAG.241, 773	LTC737XD PAG.243	LTC812 PAG.223	LTC847 PAG.193
LTC530IPD PAG.257, 774	LTC535X PAG.259	LTC560AX PAG.270	LTC732AIPD PAG.241, 773	LTC760 PAG.248	LTC812D PAG.223	LTC847D PAG.193
LTC530X PAG.259	LTC535XD PAG.259	LTC560AXD PAG.270	LTC732AX PAG.243	LTC760A PAG.248	LTC813 PAG.223	LTC847X PAG.194
LTC530XD PAG.259	LTC536 PAG.256	LTC560D PAG.268	LTC732AXD PAG.243	LTC760AD PAG.248	LTC813D PAG.223	LTC847XD PAG.194
LTC531 PAG.256	LTC536A PAG.256	LTC560X PAG.270	LTC732D PAG.240	LTC760AX PAG.250	LTC814 PAG.223	LTC848 PAG.193
LTC531A PAG.256	LTC536AD PAG.256	LTC560XD PAG.270	LTC732IP PAG.241, 773	LTC760AXD PAG.250	LTC814D PAG.223	LTC848D PAG.193
LTC531AB PAG.280, 642	LTC536AIP PAG.257, 774	LTC561 PAG.268	LTC732IPD PAG.241, 773	LTC760D PAG.248	LTC815 PAG.223	LTC848X PAG.194
LTC531ABX PAG.281, 643	LTC536AIPD PAG.257, 774	LTC561A PAG.268	LTC732X PAG.243	LTC760X PAG.250	LTC815D PAG.223	LTC848XD PAG.194
LTC531AD PAG.256	LTC536AX PAG.259	LTC561AD PAG.268	LTC732XD PAG.243	LTC760XD PAG.250	LTC816 PAG.223	LTC849 PAG.193
LTC531AIP PAG.257, 774	LTC536AXD PAG.259	LTC561AX PAG.270	LTC733 PAG.240	LTC761 PAG.248	LTC816D PAG.223	LTC849D PAG.193
LTC531AIPD PAG.257, 774	LTC536D PAG.256	LTC561AXD PAG.270	LTC733A PAG.240	LTC761A PAG.248	LTC817 PAG.223	LTC849X PAG.194
LTC531AX PAG.259	LTC536IP PAG.257, 774	LTC561D PAG.268	LTC733AD PAG.240	LTC761AD PAG.248	LTC817D PAG.223	LTC849XD PAG.194
LTC531AXD PAG.259	LTC536IPD PAG.257, 774	LTC630 PAG.316	LTC733AIP PAG.241, 773	LTC761AX PAG.250	LTC820 PAG.195	LTC850 PAG.193
LTC531B PAG.280, 642	LTC536IPD PAG.257, 774	LTC630D PAG.316	LTC733AIPD PAG.241, 773	LTC761AXD PAG.250	LTC821 PAG.195	LTC850D PAG.193
LTC531BX PAG.281, 643	LTC536XD PAG.259	LTC630X PAG.317	LTC733AX PAG.243	LTC761D PAG.248	LTC822 PAG.195	LTC850X PAG.194
LTC531BXD PAG.281, 643	LTC537 PAG.256	LTC630XD PAG.317	LTC733AXD PAG.243	LTC762 PAG.248	LTC823 PAG.195	LTC850XD PAG.194
LTC531D PAG.256	LTC537A PAG.256	LTC631 PAG.316	LTC733D PAG.240	LTC762A PAG.248	LTC824 PAG.195	LTC851 PAG.193
LTC531IP PAG.257, 774	LTC537AD PAG.256	LTC631D PAG.316	LTC733IP PAG.241, 773	LTC762AD PAG.248	LTC825 PAG.195	LTC851D PAG.193
LTC531IPD PAG.257, 774	LTC537AIP PAG.257, 774	LTC631DX PAG.317	LTC733IPD PAG.241, 773	LTC762AX PAG.250	LTC826 PAG.195	LTC851X PAG.194
LTC532 PAG.256	LTC537AIPD PAG.257, 774	LTC631X PAG.317	LTC733X PAG.243	LTC762AXD PAG.250	LTC827 PAG.195	LTC851XD PAG.194
LTC532A PAG.256	LTC537AX PAG.259	LTC632 PAG.316	LTC733XD PAG.243	LTC762D PAG.248	LTC828 PAG.195	LTC852 PAG.193
LTC532AB PAG.280, 642	LTC537AXD PAG.259	LTC632D PAG.316	LTC734 PAG.240	LTC762X PAG.250	LTC830 PAG.189	LTC852D PAG.193
LTC532ABX PAG.281, 643	LTC537D PAG.256	LTC632X PAG.317	LTC734A PAG.240	LTC762XD PAG.250	LTC830D PAG.189	LTC852X PAG.194
LTC532AD PAG.256	LTC537IP PAG.257, 774	LTC632XD PAG.317	LTC734AD PAG.240	LTC763 PAG.248	LTC830X PAG.190	LTC852XD PAG.194
LTC532AIP PAG.257, 774	LTC537IPD PAG.257, 774	LTC633 PAG.316	LTC734AIP PAG.241, 773	LTC763A PAG.248	LTC830XD PAG.190	LTC930 PAG.220
LTC532AIPD PAG.257, 774	LTC537X PAG.259	LTC633D PAG.316	LTC734AIPD PAG.241, 773	LTC763AD PAG.248	LTC831 PAG.189	LTC930D PAG.220
LTC532AX PAG.259	LTC537XD PAG.259	LTC633X PAG.317	LTC734AX PAG.243	LTC763AX PAG.250	LTC831D PAG.189	LTC931 PAG.220
LTC532AXD PAG.259	LTC555 PAG.268	LTC633XD PAG.317	LTC734AXD PAG.243	LTC763AXD PAG.250	LTC831X PAG.190	LTC931D PAG.220
LTC532B PAG.280, 642	LTC634 PAG.316	LTC634 PAG.316	LTC734D PAG.240	LTC763D PAG.248	LTC831XD PAG.190	LTC932 PAG.220
LTC532BX PAG.281, 643	LTC634AD PAG.317	LTC634AD PAG.316	LTC734IP PAG.241, 773	LTC763X PAG.250	LTC832 PAG.189	LTC932D PAG.220
LTC532BXD PAG.281, 643	LTC634AXD PAG.317	LTC634AXD PAG.317	LTC734IPD PAG.241, 773	LTC763XD PAG.250	LTC832D PAG.189	LTC933 PAG.220
LTC532D PAG.256	LTC555AXD PAG.270	LTC635 PAG.316	LTC734X PAG.243	LTC764 PAG.248	LTC832X PAG.190	LTC933D PAG.220
LTC532IP PAG.257, 774	LTC555D PAG.268	LTC635X PAG.316	LTC734XD PAG.243	LTC764A PAG.248	LTC832XD PAG.190	LTC934 PAG.220
LTC532IPD PAG.257, 774	LTC555X PAG.270	LTC635XD PAG.316	LTC735 PAG.240	LTC764AD PAG.248	LTC833 PAG.189	LTC934D PAG.220
LTC532X PAG.259	LTC555XD PAG.270	LTC635X PAG.317	LTC735A PAG.240	LTC764AX PAG.250	LTC833D PAG.189	LTC935 PAG.220
LTC532XD PAG.259	LTC556 PAG.268	LTC635XD PAG.317	LTC735AD PAG.240	LTC764AXD PAG.250	LTC833X PAG.190	LTC935D PAG.220
LTC533 PAG.256	LTC556A PAG.268	LTC636 PAG.316	LTC735AIP PAG.241, 773	LTC764AD PAG.248	LTC833XD PAG.190	LTC936 PAG.220
LTC533A PAG.256	LTC556AD PAG.268	LTC636D PAG.316	LTC735AIPD PAG.241, 773	LTC764X PAG.250	LTC834 PAG.189	LTC936D PAG.220





LTSC33D PAG.384	LV003.940W PAG.65	LV021.930W PAG.72	LV033.930WD PAG.76	LV044.940WD PAG.69	LV081.940S PAG.74	LV104.930WD PAG.83 153
LTSC34 PAG.385	LV004.927F PAG.65	LV021.940F PAG.72	LV033.940F PAG.76	LV051.927F PAG.70	LV081.940SD PAG.74	LV104.940F PAG.83 153
LTSC34D PAG.385	LV004.927S PAG.65	LV021.940S PAG.72	LV033.940FD PAG.76	LV051.927S PAG.70	LV081.940W PAG.74	LV104.940FD PAG.83 153
LTSC35 PAG.385	LV004.927W PAG.65	LV021.940W PAG.72	LV033.940S PAG.76	LV051.927W PAG.70	LV081.940WD PAG.74	LV104.940S PAG.83 153
LTSC35D PAG.385	LV004.930F PAG.65	LV022.927F PAG.72	LV033.940SD PAG.76	LV051.930F PAG.70	LV082.927F PAG.75	LV104.940SD PAG.83 153
LTSC36 PAG.385	LV004.930S PAG.65	LV022.927S PAG.72	LV033.940W PAG.76	LV051.930S PAG.70	LV082.927FD PAG.75	LV104.940W PAG.83 153
LTSC36D PAG.385	LV004.930W PAG.65	LV022.927W PAG.72	LV033.940WD PAG.76	LV051.930W PAG.70	LV082.927S PAG.75	LV104.940WD PAG.83 153
LTSC37 PAG.383	LV004.940F PAG.65	LV022.930F PAG.72	LV041.927F PAG.68	LV051.940F PAG.70	LV082.927SD PAG.75	LV105.927F PAG.83 154
LTSC37D PAG.383	LV004.940S PAG.65	LV022.930S PAG.72	LV041.927S PAG.68	LV051.940S PAG.70	LV082.927W PAG.75	LV105.927FD PAG.83 154
LTSC38 PAG.383	LV004.940W PAG.65	LV022.930W PAG.72	LV041.927W PAG.68	LV051.940W PAG.70	LV082.927WD PAG.75	LV105.927S PAG.83 154
LTSC38D PAG.383	LV005.927F PAG.66	LV022.940F PAG.72	LV041.930F PAG.68	LV052.927F PAG.70	LV082.930F PAG.75	LV105.927SD PAG.83 154
LTSC66 PAG.382	LV005.927S PAG.66	LV022.940S PAG.72	LV041.930S PAG.68	LV052.927S PAG.70	LV082.930FD PAG.75	LV105.927W PAG.83 154
LTSC66D PAG.382	LV005.927W PAG.66	LV022.940W PAG.72	LV041.930W PAG.68	LV052.927W PAG.70	LV082.930S PAG.75	LV105.927WD PAG.83 154
LTSC67 PAG.382	LV005.930F PAG.66	LV023.927F PAG.73	LV041.940F PAG.68	LV052.930F PAG.70	LV082.930SD PAG.75	LV105.930F PAG.83 154
LTSC67D PAG.382	LV005.930S PAG.66	LV023.927S PAG.73	LV041.940S PAG.68	LV052.930S PAG.70	LV082.930W PAG.75	LV105.930FD PAG.83 154
LTSC68 PAG.382	LV005.930W PAG.66	LV023.927W PAG.73	LV041.940W PAG.68	LV052.930W PAG.70	LV082.930WD PAG.75	LV105.930S PAG.83 154
LTSC68D PAG.382	LV005.940F PAG.66	LV023.930F PAG.73	LV042.927F PAG.68	LV052.940F PAG.70	LV082.940F PAG.75	LV105.930SD PAG.83 154
LTSCC37 PAG.383	LV005.940S PAG.66	LV023.930S PAG.73	LV042.927FD PAG.68	LV052.940S PAG.70	LV082.940FD PAG.75	LV105.930W PAG.83 154
LTSCC37D PAG.383	LV005.940W PAG.66	LV023.930W PAG.73	LV042.927S PAG.68	LV052.940W PAG.70	LV082.940S PAG.75	LV105.930WD PAG.83 154
LTSCC38 PAG.383	LV011.927F PAG.60	LV023.940F PAG.73	LV042.927SD PAG.68	LV061.927F PAG.66	LV082.940SD PAG.75	LV105.940F PAG.83 154
LTSCC38D PAG.383	LV011.927S PAG.60	LV023.940S PAG.73	LV042.927W PAG.68	LV061.927S PAG.66	LV082.940W PAG.75	LV105.940FD PAG.83 154
LTSCC66 PAG.382	LV011.927W PAG.60	LV023.940W PAG.73	LV042.927WD PAG.68	LV061.927W PAG.66	LV082.940WD PAG.75	LV105.940S PAG.83 154
LTSCC66D PAG.382	LV011.930F PAG.60	LV024.927F PAG.73	LV042.930F PAG.68	LV061.930F PAG.66	LV102.927F PAG.82 152	LV105.940SD PAG.83 154
LTSCC67 PAG.382	LV011.930S PAG.60	LV024.927S PAG.73	LV042.930FD PAG.68	LV061.930S PAG.66	LV102.927FD PAG.82 152	LV105.940W PAG.83 154
LTSCC67D PAG.382	LV011.930W PAG.60	LV024.927W PAG.73	LV042.930S PAG.68	LV061.930W PAG.66	LV102.927S PAG.82 152	LV105.940WD PAG.83 154
LTSCC68 PAG.382	LV011.940F PAG.60	LV024.930F PAG.73	LV042.930SD PAG.68	LV061.940F PAG.66	LV102.927SD PAG.82 152	LV111.927F PAG.85
LTSCC68D PAG.382	LV011.940S PAG.60	LV024.930S PAG.73	LV042.930W PAG.68	LV061.940S PAG.66	LV102.927W PAG.82 152	LV111.927S PAG.85
LTSF13 PAG.384	LV011.940W PAG.60	LV024.930W PAG.73	LV042.930WD PAG.68	LV061.940W PAG.66	LV102.927WD PAG.82 152	LV111.927W PAG.85
LTSF13D PAG.384	LV012.927F PAG.60	LV024.940F PAG.73	LV042.940F PAG.68	LV062.927F PAG.67	LV102.930F PAG.82 152	LV111.930F PAG.85
LTSF14 PAG.384	LV012.927S PAG.60	LV024.940S PAG.73	LV042.940FD PAG.68	LV062.927S PAG.67	LV102.930FD PAG.82 152	LV111.930S PAG.85
LTSF14D PAG.384	LV012.927W PAG.60	LV024.940W PAG.73	LV042.940S PAG.68	LV062.927W PAG.67	LV102.930S PAG.82 152	LV111.930W PAG.85
LTSF15 PAG.384	LV012.930F PAG.60	LV025.927F PAG.74	LV042.940SD PAG.68	LV062.930F PAG.67	LV102.930SD PAG.82 152	LV111.940F PAG.85
LTSF15D PAG.384	LV012.930S PAG.60	LV025.927S PAG.74	LV042.940W PAG.68	LV062.930S PAG.67	LV102.930W PAG.82 152	LV111.940S PAG.85
LTT1.1000 PAG.208, 231	LV012.930W PAG.60	LV025.927W PAG.74	LV042.940WD PAG.68	LV062.930W PAG.67	LV102.930WD PAG.82 152	LV111.940W PAG.85
LTT1.2000 PAG.208, 231	LV012.940F PAG.60	LV025.930F PAG.74	LV043.927F PAG.69	LV062.940F PAG.67	LV102.940F PAG.82 152	LV112.927F PAG.85
LTT1.3000 PAG.208, 231	LV012.940S PAG.60	LV025.930S PAG.74	LV043.927FD PAG.69	LV062.940S PAG.67	LV102.940FD PAG.82 152	LV112.927FD PAG.85
LTT1.misura <sup>®</sup> PAG.208, 231	LV012.940W PAG.60	LV025.930W PAG.74	LV043.927S PAG.69	LV062.940W PAG.67	LV102.940S PAG.82 152	LV112.927S PAG.85
LTT2.1000 PAG.299, 330	LV013.927F PAG.61	LV025.940F PAG.74	LV043.927SD PAG.69	LV071.927F PAG.62	LV102.940SD PAG.82 152	LV112.927SD PAG.85
LTT2.2000 PAG.299, 330	LV013.927S PAG.61	LV025.940S PAG.74	LV043.927W PAG.69	LV071.927S PAG.62	LV102.940W PAG.82 152	LV112.927W PAG.85
LTT2.3000 PAG.299, 330	LV013.927W PAG.61	LV025.940W PAG.74	LV043.927WD PAG.69	LV071.927W PAG.62	LV102.940WD PAG.82 152	LV112.927WD PAG.85
LTT2.misura <sup>®</sup> PAG.299, 330	LV013.930F PAG.61	LV032.927F PAG.76	LV043.930F PAG.69	LV071.930F PAG.62	LV103.927F PAG.82 153	LV112.930F PAG.85
LTX001 PAG.204, 227, 292, 325	LV013.930S PAG.61	LV032.927FD PAG.76	LV043.930FD PAG.69	LV071.930S PAG.62	LV103.927FD PAG.82 153	LV112.930FD PAG.85
	LV013.930W PAG.61	LV032.927S PAG.76	LV043.930S PAG.69	LV071.930W PAG.62	LV103.927S PAG.82 153	LV112.930S PAG.85
LV001.927F PAG.64	LV013.940F PAG.61	LV032.927SD PAG.76	LV043.930SD PAG.69	LV071.940F PAG.62	LV103.927SD PAG.82 153	LV112.930SD PAG.85
LV001.927S PAG.64	LV013.940S PAG.61	LV032.927W PAG.76	LV043.930W PAG.69	LV071.940S PAG.62	LV103.927W PAG.82 153	LV112.930W PAG.85
LV001.927W PAG.64	LV013.940W PAG.61	LV032.927WD PAG.76	LV043.930WD PAG.69	LV071.940W PAG.62	LV103.927WD PAG.82 153	LV112.930WD PAG.85
LV001.930F PAG.64	LV014.927F PAG.61	LV032.930F PAG.76	LV043.940F PAG.69	LV072.927F PAG.63	LV103.930F PAG.82 153	LV112.940F PAG.85
LV001.930S PAG.64	LV014.927S PAG.61	LV032.930FD PAG.76	LV043.940FD PAG.69	LV072.927S PAG.63	LV103.930FD PAG.82 153	LV112.940FD PAG.85
LV001.930W PAG.64	LV014.927W PAG.61	LV032.930S PAG.76	LV043.940S PAG.69	LV072.927W PAG.63	LV103.930S PAG.82 153	LV112.940S PAG.85
LV001.940F PAG.64	LV014.930F PAG.61	LV032.930SD PAG.76	LV043.940SD PAG.69	LV072.930F PAG.63	LV103.930SD PAG.82 153	LV112.940SD PAG.85
LV001.940S PAG.64	LV014.930S PAG.61	LV032.930W PAG.76	LV043.940W PAG.69	LV072.930S PAG.63	LV103.930W PAG.82 153	LV112.940W PAG.85
LV001.940W PAG.64	LV014.930W PAG.61	LV032.930WD PAG.76	LV043.940WD PAG.69	LV072.930W PAG.63	LV103.930WD PAG.82 153	LV112.940WD PAG.85
LV002.927F PAG.64	LV014.940F PAG.61	LV032.940F PAG.76	LV044.927F PAG.69	LV072.940F PAG.63	LV103.940F PAG.82 153	LV113.927F PAG.86
LV002.927S PAG.64	LV014.940S PAG.61	LV032.940FD PAG.76	LV044.927FD PAG.69	LV072.940S PAG.63	LV103.940FD PAG.82 153	LV113.927FD PAG.86
LV002.927W PAG.64	LV014.940W PAG.61	LV032.940S PAG.76	LV044.927S PAG.69	LV072.940W PAG.63	LV103.940S PAG.82 153	LV113.927S PAG.86
LV002.930F PAG.64	LV015.927F PAG.62	LV032.940SD PAG.76	LV044.927SD PAG.69	LV081.927F PAG.74	LV103.940SD PAG.82 153	LV113.927SD PAG.86
LV002.930S PAG.64	LV015.927S PAG.62	LV032.940W PAG.76	LV044.927W PAG.69	LV081.927FD PAG.74	LV103.940W PAG.82 153	LV113.927W PAG.86
LV002.930W PAG.64	LV015.927W PAG.62	LV032.940WD PAG.76	LV044.927WD PAG.69	LV081.927S PAG.74	LV103.940WD PAG.82 153	LV113.927WD PAG.86
LV002.940F PAG.64	LV015.930F PAG.62	LV033.927F PAG.76	LV044.930F PAG.69	LV081.927SD PAG.74	LV104.927F PAG.83 153	LV113.930F PAG.86
LV002.940S PAG.64	LV015.930S PAG.62	LV033.927FD PAG.76	LV044.930FD PAG.69	LV081.927W PAG.74	LV104.927FD PAG.83 153	LV113.930FD PAG.86
LV002.940W PAG.64	LV015.930W PAG.62	LV033.927S PAG.76	LV044.930S PAG.69	LV081.927WD PAG.74	LV104.927S PAG.83 153	LV113.930S PAG.86
LV003.927F PAG.65	LV015.940F PAG.62	LV033.927SD PAG.76	LV044.930SD PAG.69	LV081.930F PAG.74	LV104.927SD PAG.83 153	LV113.930SD PAG.86
LV003.927S PAG.65	LV015.940S PAG.62	LV033.927W PAG.76	LV044.930W PAG.69	LV081.930FD PAG.74	LV104.927W PAG.83 153	LV113.930W PAG.86
LV003.927W PAG.65	LV015.940W PAG.62	LV033.927WD PAG.76	LV044.930WD PAG.69	LV081.930S PAG.74	LV104.927WD PAG.83 153	LV113.930WD PAG.86
LV003.930F PAG.65	LV021.927F PAG.72	LV033.930F PAG.76	LV044.940F PAG.69	LV081.930SD PAG.74	LV104.930F PAG.83 153	LV113.940F PAG.86
LV003.930S PAG.65	LV021.927S PAG.72	LV033.930FD PAG.76	LV044.940FD PAG.69	LV081.930W PAG.74	LV104.930FD PAG.83 153	LV113.940FD PAG.86
LV003.930W PAG.65	LV021.927W PAG.72	LV033.930S PAG.76	LV044.940S PAG.69	LV081.930WD PAG.74	LV104.930S PAG.83 153	LV113.940S PAG.86
LV003.940F PAG.65	LV021.930F PAG.72	LV033.930SD PAG.76	LV044.940SD PAG.69	LV081.940F PAG.74	LV104.930SD PAG.83 153	LV113.940SD PAG.86
LV003.940S PAG.65	LV021.930S PAG.72	LV033.930W PAG.76	LV044.940W PAG.69	LV081.940FD PAG.74	LV104.930W PAG.83 153	LV113.940W PAG.86

LV113.940WD PAG.86	LV202.930W PAG.78	MF06.2 PAG.114, 778	MO039D PAG.164	NF015.930F PAG.443	PH001.930S PAG.596	PH104.927F PAG.597
LV114.927F PAG.86	LV202.940F PAG.78	MF06.C1 PAG.115, 779	MO040 PAG.165	NF019 PAG.443	PH001.930SD PAG.596	PH104.927FD PAG.597
LV114.927FD PAG.86	LV202.940S PAG.78	MF06.C2 PAG.115, 779	MO040D PAG.165	NF020.930F PAG.442	PH001.930SDF PAG.596	PH104.927FDF PAG.597
LV114.927S PAG.86	LV202.940W PAG.78	M101 PAG.813	MO041 PAG.165	NF020.930W PAG.442	PH001.930W PAG.596	PH104.927S PAG.597
LV114.927SD PAG.86	LV203.927F PAG.79	MO000.566 PAG.166	MO041D PAG.165	NF020.940F PAG.442	PH001.930WD PAG.596	PH104.927SD PAG.597
LV114.927W PAG.86	LV203.927FD PAG.79	MO000.589 PAG.166	MO042 PAG.165	NF020.940W PAG.442	PH001.930WDF PAG.596	PH104.927SDF PAG.597
LV114.927WD PAG.86	LV203.927S PAG.79	MO000.846 PAG.166	MO042D PAG.165	NF022.927F PAG.442	PH001.940F PAG.596	PH104.927W PAG.597
LV114.930F PAG.86	LV203.927SD PAG.79	MO000.889 PAG.166	MO043 PAG.165	NF022.927S PAG.442	PH001.940FD PAG.596	PH104.927WD PAG.597
LV114.930FD PAG.86	LV203.927W PAG.79	MO000.1126 PAG.166	MO043D PAG.165	NF022.930F PAG.442	PH001.940FDF PAG.596	PH104.927WDF PAG.597
LV114.930S PAG.86	LV203.927WD PAG.79	MO000.1189 PAG.166	MO044 PAG.165	NF022.930S PAG.442	PH001.940S PAG.596	PH104.930F PAG.597
LV114.930SD PAG.86	LV203.930F PAG.79	MO000.1406 PAG.166	MO044D PAG.165	NF022.940F PAG.442	PH001.940SD PAG.596	PH104.930FD PAG.597
LV114.930W PAG.86	LV203.930FD PAG.79	MO000.1686 PAG.166	MO045 PAG.165	NF022.940S PAG.442	PH001.940SDF PAG.596	PH104.930FDF PAG.597
LV114.930WD PAG.86	LV203.930S PAG.79	MO000.1774 PAG.166	MO045D PAG.165	NF027 PAG.442	PH001.940W PAG.596	PH104.930S PAG.597
LV114.940F PAG.86	LV203.930SD PAG.79	MO000.2374 PAG.166	MO046 PAG.165	NF028 PAG.442	PH001.940WD PAG.596	PH104.930SD PAG.597
LV114.940FD PAG.86	LV203.930W PAG.79	MO000.3000 PAG.166	MO046D PAG.165	NF032.927F PAG.443	PH001.940WDF PAG.596	PH104.930SDF PAG.597
LV114.940S PAG.86	LV203.930WD PAG.79	MO000.misura* PAG.166	MO047 PAG.165	NF032.927S PAG.443	PH004.927F PAG.596	PH104.930W PAG.597
LV114.940SD PAG.86	LV203.940F PAG.79	MO004.573 PAG.166	MO047D PAG.165	NF040.930F PAG.444	PH004.927FD PAG.596	PH104.930WD PAG.597
LV114.940W PAG.86	LV203.940FD PAG.79	MO004.586 PAG.166	MO048 PAG.165	NF040.930S PAG.444	PH004.927FDF PAG.596	PH104.930WDF PAG.597
LV114.940WD PAG.86	LV203.940S PAG.79	MO004.853 PAG.166	MO048D PAG.165	NF040.930W PAG.444	PH004.927S PAG.596	PH104.940F PAG.597
LV121.927F PAG.84, 305	LV203.940SD PAG.79	MO004.886 PAG.166	MO049 PAG.165	NF040.940F PAG.444	PH004.927SD PAG.596	PH104.940FD PAG.597
LV121.927FD PAG.84, 305	LV203.940W PAG.79	MO004.1133 PAG.166	MO049D PAG.165	NF040.940S PAG.444	PH004.927SDF PAG.596	PH104.940FDF PAG.597
LV121.927S PAG.84, 305	LV203.940WD PAG.79	MO004.1186 PAG.166	MO120 PAG.165, 637	NF040.940W PAG.444	PH004.927W PAG.596	PH104.940S PAG.597
LV121.927SD PAG.84, 305	LVKIT5 PAG.71	MO004.1413 PAG.166	MO121 PAG.165, 637	NF050.930F PAG.445	PH004.927WD PAG.596	PH104.940SD PAG.597
LV121.927W PAG.84, 305	LVKIT10 PAG.71	MO004.1693 PAG.166	MO121D PAG.165, 637	NF050.930S PAG.445	PH004.927WDF PAG.596	PH104.940SDF PAG.597
LV121.927WD PAG.84, 305	LVKL01 PAG.349	MO004.1771 PAG.166	MO122 PAG.165, 637	NF050.930W PAG.445	PH004.930F PAG.596	PH104.940W PAG.597
LV121.930F PAG.84, 305	LY9003.1 PAG.648	MO004.2371 PAG.166	MO122D PAG.165, 637	NF050.940F PAG.445	PH004.930FD PAG.596	PH104.940WD PAG.597
LV121.930FD PAG.84, 305		MO004.3000 PAG.166	MO123 PAG.165, 637	NF050.940S PAG.445	PH004.930FDF PAG.596	PH104.940WDF PAG.597
LV121.930S PAG.84, 305	M	MO004.misura PAG.166	MO124 PAG.165, 637	NF050.940W PAG.445	PH004.930S PAG.596	PH107.927F PAG.597
LV121.930SD PAG.84, 305	MF00DP.1000 PAG.120	MO005 PAG.166	MO124D PAG.165, 637	NF060.930F PAG.444	PH004.930SD PAG.596	PH107.927FD PAG.597
LV121.930W PAG.84, 305	MF00DP.2000 PAG.120	MO007 PAG.167	MP001 PAG.815	NF060.930S PAG.444	PH004.930SDF PAG.596	PH107.927S PAG.597
LV121.930WD PAG.84, 305	MF00DP.3000 PAG.120	MO020 PAG.164	MP001 PAG.815	NF060.930W PAG.444	PH004.930W PAG.596	PH107.927SD PAG.597
LV121.940F PAG.84, 305	MF0.T PAG.118	MO020D PAG.164	MV001 PAG.501	NF060.940F PAG.444	PH004.930WD PAG.596	PH107.927W PAG.597
LV121.940FD PAG.84, 305	MF0.TA PAG.121	MO021 PAG.164	MV002 PAG.501	NF060.940S PAG.444	PH004.930WDF PAG.596	PH107.927WD PAG.597
LV121.940S PAG.84, 305	MF00TI PAG.118	MO021D PAG.164	MV011 PAG.501	NF060.940W PAG.444	PH004.940F PAG.596	PH107.930F PAG.597
LV121.940SD PAG.84, 305	MF00TP PAG.119	MO022 PAG.164	MV011 PAG.501	NF070.930F PAG.445	PH004.940FD PAG.596	PH107.930FD PAG.597
LV121.940W PAG.84, 305	MF01.1 PAG.115	MO022D PAG.164	MV012 PAG.501	NF070.930S PAG.445	PH004.940FDF PAG.596	PH107.930S PAG.597
LV121.940WD PAG.84, 305	MF01.2 PAG.115	MO023 PAG.164	MV021 PAG.501	NF070.930W PAG.445	PH004.940S PAG.596	PH107.930SD PAG.597
LV122.927F PAG.84, 305	MF01.3 PAG.115	MO023D PAG.164	MV050.927 PAG.501	NF070.940F PAG.445	PH004.940SD PAG.596	PH107.930W PAG.597
LV122.927FD PAG.84, 305	MF01.90 PAG.119	MO024 PAG.164	MV050.930 PAG.501	NF070.940S PAG.445	PH004.940SDF PAG.596	PH107.930WD PAG.597
LV122.927S PAG.84, 305	MF01.1000 PAG.119	MO025 PAG.164	MV050.940 PAG.501	NFD00.930W PAG.447	PH004.940W PAG.596	PH107.940F PAG.597
LV122.927SD PAG.84, 305	MF01.2000 PAG.119	MO025D PAG.164	MV055.927 PAG.503	NFD00.930W PAG.447	PH004.940WDF PAG.596	PH107.940FD PAG.597
LV122.927W PAG.84, 305	MF01.3000 PAG.119	MO026 PAG.164	MV055.940 PAG.503	NFD00X.930W PAG.447	PH101.927F PAG.597	PH107.940SD PAG.597
LV122.927WD PAG.84, 305	MF01.misura* PAG.119	MO026D PAG.164	MV056.927 PAG.503		PH101.927FD PAG.597	PH107.940WD PAG.597
LV122.930F PAG.84, 305	MF01.PS PAG.120	MO027 PAG.164	MV056.930 PAG.503	O	PH101.927FDF PAG.597	PH107.940WD PAG.597
LV122.930FD PAG.84, 305	MF01.T PAG.120	MO027D PAG.164	MV056.940 PAG.503	OR11 PAG.806	PH101.927S PAG.597	PH151.927F PAG.601
LV122.930S PAG.84, 305	MF01.X PAG.119	MO028 PAG.164	MV100.927F PAG.496	OR12 PAG.806	PH101.927SD PAG.597	PH151.927FD PAG.601
LV122.930SD PAG.84, 305	MF02.X PAG.114	MO028D PAG.164	MV100.927S PAG.496	OR16 PAG.807	PH101.927SDF PAG.597	PH151.927FDF PAG.601
LV122.930W PAG.84, 305	MF02.2 PAG.114	MO029 PAG.164	MV100.927W PAG.496	OR141 PAG.806	PH101.927W PAG.597	PH151.927S PAG.601
LV122.930WD PAG.84, 305	MF02.3 PAG.114	MO029D PAG.164	MV100.930F PAG.496	OR142 PAG.807	PH101.927WD PAG.597	PH151.927SD PAG.601
LV122.940F PAG.84, 305	MF02.90 PAG.118	MO030 PAG.164	MV100.930S PAG.496	OR151 PAG.806	PH101.927WDF PAG.597	PH151.927SDF PAG.601
LV122.940FD PAG.84, 305	MF02.1000 PAG.118	MO030D PAG.164	MV100.930W PAG.496	OR152 PAG.807	PH101.930F PAG.597	PH151.927W PAG.601
LV122.940S PAG.84, 305	MF02.2000 PAG.118	MO031 PAG.164	MV100.940F PAG.496		PH101.930FD PAG.597	PH151.927WD PAG.601
LV122.940SD PAG.84, 305	MF02.3000 PAG.118	MO031D PAG.164	MV100.940S PAG.496	P	PH101.930FDF PAG.597	PH151.927WDF PAG.601
LV122.940W PAG.84, 305	MF02.misura* PAG.118	MO032 PAG.164	MV100.940W PAG.496	PH001.927F PAG.596	PH101.930S PAG.597	PH151.930F PAG.601
LV122.940WD PAG.84, 305	MF02.SF PAG.118	MO032D PAG.164	MV200.927F PAG.497	PH001.927FD PAG.596	PH101.930SD PAG.597	PH151.930FD PAG.601
LV201.927F PAG.78	MF02.X PAG.118	MO033 PAG.164	MV200.927S PAG.497	PH001.927FDF PAG.596	PH101.930SDF PAG.597	PH151.930FDF PAG.601
LV201.927S PAG.78	MF03.1 PAG.115	MO033D PAG.164	MV200.927W PAG.497	PH001.927S PAG.596	PH101.930W PAG.597	PH151.930S PAG.601
LV201.927W PAG.78	MF03.2 PAG.115	MO034 PAG.164	MV200.930F PAG.497	PH001.927SD PAG.596	PH101.930WD PAG.597	PH151.930SD PAG.601
LV201.930F PAG.78	MF03.3 PAG.115	MO034D PAG.164	MV200.930S PAG.497	PH001.927SDF PAG.596	PH101.930WDF PAG.597	PH151.930SDF PAG.601
LV201.930S PAG.78	MF04.1000 PAG.121	MO035 PAG.164	MV200.930W PAG.497	PH001.927SDF PAG.596	PH101.940F PAG.597	PH151.930W PAG.601
LV201.930W PAG.78	MF04.2000 PAG.121	MO035D PAG.164	MV200.940F PAG.497	PH001.927SDF PAG.596	PH101.940FD PAG.597	PH151.930WDF PAG.601
LV201.940F PAG.78	MF04.3000 PAG.121	MO036 PAG.164	MV200.940S PAG.497	PH001.927SDF PAG.596	PH101.940FDF PAG.597	PH151.930WDF PAG.601
LV201.940S PAG.78	MF04.misura* PAG.121	MO036D PAG.164	MV200.940W PAG.497	PH001.927W PAG.596	PH101.940FD PAG.597	PH151.940F PAG.601
LV201.940W PAG.78	MF05.1 PAG.114	MO037 PAG.164		PH001.927WD PAG.596	PH101.940SD PAG.597	PH151.940FD PAG.601
LV202.927F PAG.78	MF05.2 PAG.114	MO037D PAG.164	N	PH001.927WDF PAG.596	PH101.940SDF PAG.597	PH151.940FDF PAG.601
LV202.927S PAG.78	MF05.3 PAG.114	MO038 PAG.164	NF010.930F PAG.442	PH001.930F PAG.596	PH101.940W PAG.597	PH151.940S PAG.601
LV202.927W PAG.78	MF05.SF PAG.119	MO038D PAG.164	NF014 PAG.442	PH001.930FD PAG.596	PH101.940WD PAG.597	PH151.940SD PAG.601
LV202.930F PAG.78	MF06.1 PAG.114, 778	MO039 PAG.164		PH001.930FDF PAG.596	PH101.940WDF PAG.597	PH151.940SDF PAG.601
LV202.930S PAG.78						







SE402.940S PAG.583	SE423.930SD PAG.584	SE521.927W PAG.589	SG001.930S PAG.394	TES40 PAG.803
SE402.940SD PAG.583	SE423.930W PAG.584	SE521.927WD PAG.589	SG001.940F PAG.394	TES50 PAG.803
SE402.940SDF PAG.583	SE423.930WD PAG.584	SE521.927WDF PAG.589	SG001.940S PAG.394	TES60 PAG.803
SE402.940W PAG.583	SE423.940F PAG.584	SE521.930F PAG.589	SG011 PAG.395	TES80 PAG.803
SE402.940WD PAG.583	SE423.940FD PAG.584	SE521.930FD PAG.589	SG012 PAG.395	TTS58 PAG.722
SE402.940WDF PAG.583	SE423.940S PAG.584	SE521.930FDF PAG.589	SG021.927F PAG.394	TW001 PAG.465
SE421.927F PAG.584	SE423.940SD PAG.584	SE521.930S PAG.589	SG021.927S PAG.394	TW002 PAG.475
SE421.927FD PAG.584	SE423.940W PAG.584	SE521.930SD PAG.589	SG021.927W PAG.394	TW003 PAG.475
SE421.927FDF PAG.584	SE423.940WD PAG.584	SE521.930SDF PAG.589	SG021.930F PAG.394	TW020.927 PAG.465
SE421.927S PAG.584	SE501.927F PAG.588	SE521.930WDF PAG.589	SG021.930S PAG.394	TW020.930 PAG.465
SE421.927SD PAG.584	SE501.927FD PAG.588	SE521.930WD PAG.589	SG021.930W PAG.394	TW020.940 PAG.465
SE421.927SDF PAG.584	SE501.927FDF PAG.588	SE521.930WDF PAG.589	SG021.940F PAG.394	TW021.927 PAG.465
SE421.927W PAG.584	SE501.927S PAG.588	SE521.930WDF PAG.589	SG021.940S PAG.394	TW021.930 PAG.465
SE421.927WD PAG.584	SE501.927SD PAG.588	SE521.940F PAG.589	SG021.940W PAG.394	TW021.940 PAG.465
SE421.927WDF PAG.584	SE501.927SDF PAG.588	SE521.940FDF PAG.589	SG031 PAG.395	TW025.927 PAG.467
SE421.930F PAG.584	SE501.927W PAG.588	SE521.940S PAG.589	SM20 PAG.721	TW025.930 PAG.467
SE421.930FD PAG.584	SE501.927WD PAG.588	SE521.940SD PAG.589	SM40 PAG.721	TW025.940 PAG.467
SE421.930FDF PAG.584	SE501.927WDF PAG.588	SE521.940SDF PAG.589	SM50 PAG.721	TW026.927 PAG.467
SE421.930S PAG.584	SE501.930F PAG.588	SE521.940W PAG.589	SM60 PAG.721	TW026.930 PAG.467
SE421.930SD PAG.584	SE501.930FD PAG.588	SE521.940WD PAG.589	SRA2 PAG.726	TW026.940 PAG.467
SE421.930SDF PAG.584	SE501.930FDF PAG.588	SE521.940WDF PAG.589	SRA4 PAG.727	TW030.927F PAG.471
SE421.930W PAG.584	SE501.930S PAG.588	SE522.927F PAG.589	SRA20 PAG.726	TW030.927S PAG.471
SE421.930WD PAG.584	SE501.930SD PAG.588	SE522.927FD PAG.589	SRA30 PAG.726	TW030.930F PAG.471
SE421.930WDF PAG.584	SE501.930SDF PAG.588	SE522.927FDF PAG.589	SRA50 PAG.727	TW030.930S PAG.471
SE421.940F PAG.584	SE501.930W PAG.588	SE522.927S PAG.589	SRS2 PAG.725	TW030.940F PAG.471
SE421.940FD PAG.584	SE501.930WD PAG.588	SE522.927SD PAG.589	SRS4 PAG.725	TW030.940S PAG.471
SE421.940FDF PAG.584	SE501.930WDF PAG.588	SE522.927SDF PAG.589	SRT4 PAG.728	TW035.927 PAG.473
SE421.940S PAG.584	SE501.940F PAG.588	SE522.927SDF PAG.589	SRT6 PAG.728	TW035.930 PAG.473
SE421.940SD PAG.584	SE501.940FD PAG.588	SE522.927WD PAG.589	ST1 PAG.521	TW035.940 PAG.473
SE421.940SDF PAG.584	SE501.940FDF PAG.588	SE522.927WDF PAG.589	ST05.30.5 PAG.121, 152,	TW036.927 PAG.473
SE421.940W PAG.584	SE501.940S PAG.588	SE522.930F PAG.589	169, 206, 229,	TW036.930 PAG.473
SE421.940WD PAG.584	SE501.940SD PAG.588	SE522.930FD PAG.589	295, 329, 350,	TW036.940 PAG.473
SE421.940WDF PAG.584	SE501.940SDF PAG.588	SE522.930FDF PAG.589	371, 393, 551	TW070 PAG.471
SE422.927F PAG.584	SE501.940W PAG.588	SE522.930S PAG.589	ST10.30.5 PAG.121, 152,	TW071 PAG.465
SE422.927FD PAG.584	SE501.940WD PAG.588	SE522.930SD PAG.589	169, 206, 229,	TW080 PAG.467
SE422.927FDF PAG.584	SE501.940WDF PAG.588	SE522.930SDF PAG.589	295, 329, 350,	TW081 PAG.469
SE422.927S PAG.584	SE502.927F PAG.588	SE522.930W PAG.589	371, 393, 551	TW082 PAG.469
SE422.927SD PAG.584	SE502.927FD PAG.588	SE522.930WD PAG.589	ST10.30.5IP PAG.121,	TW083 PAG.469
SE422.927SDF PAG.584	SE502.927FDF PAG.588	SE522.930WDF PAG.589	152, 169, 206,	
SE422.927W PAG.584	SE502.927S PAG.588	SE522.940F PAG.589	229, 295, 329,	V
SE422.927WD PAG.584	SE502.927SD PAG.588	SE522.940FD PAG.589	350, 371, 393,	VT/IN92 PAG.556
SE422.927WDF PAG.584	SE502.927SDF PAG.588	SE522.940FDF PAG.589	551	
SE422.930F PAG.584	SE502.927W PAG.588	SE522.940S PAG.589	ST11.30.5 PAG.52, 121,	W
SE422.930FD PAG.584	SE502.927WD PAG.588	SE522.940SD PAG.589	152, 169, 206,	
SE422.930FDF PAG.584	SE502.927WDF PAG.588	SE522.940SDF PAG.589	229, 295, 329,	WI001.930 PAG.568
SE422.930S PAG.584	SE502.930F PAG.588	SE522.940W PAG.589	350, 371, 393,	WI001.940 PAG.568
SE422.930SD PAG.584	SE502.930FD PAG.588	SE522.940WD PAG.589	551	WI002 PAG.568
SE422.930SDF PAG.584	SE502.930FDF PAG.588	SE522.940WDF PAG.589	ST15.30.5IP PAG.121,	WI003 PAG.568
SE422.930W PAG.584	SE502.930S PAG.588	SE523.927F PAG.589	152, 169, 206,	WI003D PAG.568
SE422.930WD PAG.584	SE502.930SD PAG.588	SE523.927FD PAG.589	229, 295, 329,	WI011.930 PAG.568
SE422.930WDF PAG.584	SE502.930SDF PAG.588	SE523.927S PAG.589	350, 371, 393,	WI011.940 PAG.568
SE422.940F PAG.584	SE502.930W PAG.588	SE523.927SD PAG.589	551	WI012 PAG.568
SE422.940FD PAG.584	SE502.930WD PAG.588	SE523.927W PAG.589	ST20.30.5IP PAG.121,	WI013 PAG.568
SE422.940S PAG.584	SE502.930WDF PAG.588	SE523.927WD PAG.589	152, 169, 206,	WI013D PAG.568
SE422.940SD PAG.584	SE502.940F PAG.588	SE523.930F PAG.589	229, 295, 329,	WI101.930 PAG.569
SE422.940SDF PAG.584	SE502.940FD PAG.588	SE523.930FDF PAG.589	350, 371, 393,	WI101.940 PAG.569
SE422.940W PAG.584	SE502.940FDF PAG.588	SE523.930S PAG.589	551	WI012 PAG.569
SE422.940WD PAG.584	SE502.940S PAG.588	SE523.930SD PAG.589	ST21.30.5 PAG.52, 121,	WI103 PAG.569
SE422.940WDF PAG.584	SE502.940SD PAG.588	SE523.930W PAG.589	152, 169, 206,	WI103D PAG.569
SE423.927F PAG.584	SE502.940SDF PAG.588	SE523.930WD PAG.589	229, 295, 329,	WI111.930 PAG.569
SE423.927FD PAG.584	SE502.940W PAG.588	SE523.940F PAG.589	350, 371, 393,	WI111.940 PAG.569
SE423.927S PAG.584	SE502.940WD PAG.588	SE523.940FD PAG.589	551	WI112 PAG.569
SE423.927SD PAG.584	SE502.940WDF PAG.588	SE523.940S PAG.589	T	WI113 PAG.569
SE423.927W PAG.584	SE521.927F PAG.589	SE523.940SD PAG.589	TEIN01M PAG.	WI113D PAG.569
SE423.927WD PAG.584	SE521.927FD PAG.589	SE523.940W PAG.589	TEIN02M PAG.	
SE423.930F PAG.584	SE521.927S PAG.589	SG001.927F PAG.394	TEIN03M PAG.521	
SE423.930FD PAG.584	SE521.927SD PAG.589	SG001.927S PAG.394	TEIN04M PAG.521	
SE423.930S PAG.584	SE521.927SDF PAG.589	SG001.930F PAG.394		





**lucifero's**