

**:Fabbian**

**GENERAL CATALOGUE 2017**





# GENERAL CATALOGUE 2017

—

## NOTE SULLE FINITURE

### **Vetro soffiato**

Il vetro soffiato è la risultante di una lavorazione artigianale e non industriale e seriale.

Ogni oggetto, per quanta attenzione possa mettere il maestro vetraio, sarà diverso l'uno dall'altro, sia in termini di dimensione che di forma e finitura.

Questa diversità rende ogni oggetto creato dai mastri vetrai, unico ed esclusivo.

Ogni imperfezione, quindi, sia essa in termini di forma, dimensione o finitura, non costituisce certo difetto, ma una caratteristica tipica del lavoro manuale.

## NOTE SUL BTOB

Il BtoB di Fabbian ( <http://b2b.fabbian.com:8080/login.jsf> ), vi permette di connettervi alla rete aziendale per:

- creare quotazioni per i vostri progetti
  - inserire ordini in modo immediato, monitorandone lo stato
  - verificare le date di consegna
  - visualizzare e scaricare le comunicazioni ufficiali dell'azienda
  - consultare e scaricare tutti i propri dati commerciali e amministrativi, nei formati più utilizzati
- il tutto in tempo reale, e ovunque vi troviate.

## INFORMATION ON THE GOODS' FINISHING

### **Blown glass**

Blown glass is the result of an artisanal process. It is a hand-made product that does not involve any industrial or mass production process.

Despite the abilities of the artisan, every glass will be different from the other in terms of size, shape and finish.

Every glass blown by the "Mastro vetraio" (master of glass) is unique and special.

No imperfection, in terms of size, shape and finish, is a defect, but rather the distinguishing feature of a hand-made product.

## INFORMATION ON B2B

Fabbian's B2B platform ( <http://b2b.fabbian.com:8080/login.jsf> ) allows you to connect with the company and:

- make quotations for your projects
  - efficiently make orders and follow their status
  - view the delivery dates
  - view and download official communications from Fabbian
  - browse and download all administrative information and documents (in the most common formats)
- at any time, wherever you are.

# COLLECTIONS INDEX

---

## DECORATIVE

---

LED	Aérostaf	p. 12-23
LED	Beluga	p. 24-43
NEW!	LED	Beluga Royal p. 44-49
LED	Bijou	p. 50-57
LED	Boomy	p. 58-61
LED	Cloudy	p. 62-67
LED	Crio	p. 68-73
LED	Cubetto	p. 74-87
LED	Cyclone	p. 88-91
LED	Diamond & Swirl	p. 92-97
LED	Enck	p. 98-101
LED	Eyes	p. 102-107
LED	Faretti	p. 108-123
LED	Flow	p. 124-127
LED	Giro	p. 128-133
LED	Giunco	p. 134-141
LED	Glu	p. 142-145
LED	Hungry	p. 146-149
LED	Jazz	p. 150-153
LED	Lamas	p. 154-157
NEW!	LED	Lens p. 158-165
LED	Loop	p. 166-171
LED	Lumi	p. 172-217
LED	Mono & Easy	p. 218-221
LED	Multispot	p. 222-243
NEW!	LED	Olympic p. 244-249
LED	Oru	p. 250-255
LED	Polair	p. 256-259
LED	Roofer	p. 260-267
LED	Snake	p. 268-271
LED	Sospesa	p. 272-275
LED	Spirito di Venezia	p. 276-281
LED	Stick	p. 282-293
LED	Toroidale	p. 294-297
LED	Tripla	p. 298-305
LED	Vicky	p. 306-313

## TECHNICAL

---

















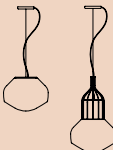











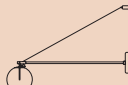
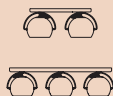





NEW!	LED	Claque	p. 316-321
LED	Cricket	p. 322-327	
LED	Pivot	p. 328-333	
LED	Puà	p. 334-337	
LED	Quadriled	p. 338-343	
LED	Quarter	p. 344-351	
LED	Slot	p. 352-357	
LED	Tools	p. 358-379	
LED	Venus	p. 380-385	
LED	Zen	p. 386-395	

## SYSTEMS

---

















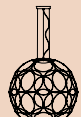

NEW!	LED	Freeline	p. 398-405
LED	Laminis	p. 406-429	
NEW!	LED	Metropole	p. 430-437
LED	Multispot	p. 438-457	
LED	Tile	p. 458-457	
LED	Tripla	p. 476-483	

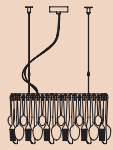
# INDEX





















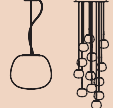









	Sospensione Hanging lamp	Tavolo Table lamp	Terra Floor lamp	Parete Wall lamp	Soffitto Ceiling lamp	Incasso Recessed lamp	Binario Light track system
<b>Aérost</b> <b>LED</b> p. 12-23 <i>Decorative</i>							
<b>Aérost</b> <b>LED</b> p. 12-23 <i>Decorative</i>							
<b>Beluga</b> <b>LED</b> <i>Decorative</i>							
<b>Colour</b> p. 24-31 <b>Steel</b> p. 32-37 <b>White</b> p. 38-43							
<b>Beluga Royal</b> <b>LED</b> p. 44-49 <i>Decorative</i>							
<b>Bijou</b> <b>LED</b> p. 50-57 <i>Decorative</i>							
<b>Bijou</b> <b>LED</b> p. 50-57 <i>Decorative</i>							
<b>Boomy</b> <b>LED</b> p. 58-61 <i>Decorative</i>							
<b>Claque</b> <b>LED</b> p. 316-321 <i>Technical</i>							
<b>Cloudy</b> <b>LED</b> p. 62-67 <i>Decorative</i>							
<b>Cricket</b> <b>LED</b> p. 322-327 <i>Technical</i>						  	

	Sospensione Hanging lamp	Tavolo Table lamp	Terra Floor lamp	Parete Wall lamp	Soffitto Ceiling lamp	Incasso Recessed lamp	Binario Light track system
<b>Crio</b> LED p. 68-73 <i>Decorative</i>							
<b>Cubetto</b> LED p. 74-87 <i>Decorative</i>							
<b>Cyclone</b> LED p. 88-91 <i>Decorative</i>							
<b>Diamond &amp; Swirl</b> p. 92-97 <i>Decorative</i>							
<b>Enck</b> LED p. 98-101 <i>Decorative</i>							
<b>Eyes</b> LED p. 102-107 <i>Decorative</i>							
<b>Faretti</b> LED p. 108-123 <i>Decorative</i>							
<b>Flow</b> p. 124-127 <i>Decorative</i>							

# INDEX



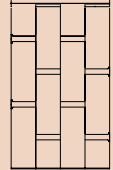



























	Sospensione Hanging lamp	Tavolo Table lamp	Terra Floor lamp	Parete Wall lamp	Soffitto Ceiling lamp	Incasso Recessed lamp	Binario Light track system
<b>Freeline</b> LED p. 398-405 <i>Systems</i>							
<b>Giro</b> LED p. 128-133 <i>Decorative</i>							
<b>Giunco</b> LED p. 134-141 <i>Decorative</i>							
<b>Glu</b> LED p. 142-145 <i>Decorative</i>							
<b>Hungry</b> p. 146-149 <i>Decorative</i>							
<b>Jazz</b> LED p. 150-153 <i>Decorative</i>							
<b>Lamas</b> LED p. 154-157 <i>Decorative</i>							
<b>Laminis</b> LED p. 406-429 <i>Systems</i>							
<b>Lens</b> LED p. 158-165 <i>Decorative</i>							
<b>Loop</b> LED p. 166-171 <i>Decorative</i>							

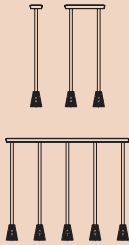
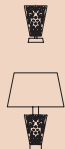

	Sospensione Hanging lamp	Tavolo Table lamp	Terra Floor lamp	Parete Wall lamp	Soffitto Ceiling lamp	Incasso Recessed lamp	Binario Light track system
<b>Lumi - Baka</b> LED p. 172-179 <i>Decorative</i>							
<b>Lumi - Mochi</b> LED p. 180-191 <i>Decorative</i>							
<b>Lumi - Mycena</b> LED p. 192-195 <i>Decorative</i>							
<b>Lumi - Poga</b> LED p. 196-199 <i>Decorative</i>							
<b>Lumi - Sfera</b> LED p. 200-213 <i>Decorative</i>							
<b>Lumi - White</b> LED p. 214-217 <i>Decorative</i>							
<b>Metropole</b> LED p. 430-437 <i>Decorative</i>							
<b>Mono &amp; Easy</b> LED p. 218-221 <i>Decorative</i>							

# INDEX

	Sospensione Hanging lamp	Tavolo Table lamp	Terra Floor lamp	Parete Wall lamp	Soffitto Ceiling lamp	Incasso Recessed lamp	Binario Light track system
<b>Multispot</b> LED p. 222-243, 438-457 <i>Decorative &amp; Systems</i>							
<b>Olympic</b> LED p. 244-249 <i>Decorative</i>							
<b>Oru</b> p. 250-255 <i>Decorative</i>							
<b>Pivot</b> LED p. 328-333 <i>Technical</i>							
<b>Polair</b> LED p. 256-259 <i>Decorative</i>							
<b>Puà</b> LED p. 334-337 <i>Technical</i>							
<b>Quadriled</b> LED p. 338-343 <i>Technical</i>							
<b>Quarter</b> LED p. 344-351 <i>Technical</i>							
<b>Roofer</b> p. 260-267 <i>Decorative</i>							
<b>Slot</b> LED p. 352-357 <i>Technical</i>							
<b>Snake</b> p. 268-271 <i>Decorative</i>							
<b>Sospesa</b> LED p. 272-275 <i>Decorative</i>							

	Sospensione Hanging lamp	Tavolo Table lamp	Terra Floor lamp	Parete Wall lamp	Soffitto Ceiling lamp	Incasso Recessed lamp	Binario Light track system
<b>Spirito di Venezia</b> p. 276-281 <i>Decorative</i>							
<b>Stick</b>  p. 282-293 <i>Decorative</i>							
<b>Tile</b>  p. 458-475 <i>Systems</i>							
<b>Tools</b>  p. 358-379 <i>Technical</i>							
<b>Toroidale</b> p. 294-297 <i>Decorative</i>							
<b>Tripla</b>  p. 298-305, 476-483 <i>Decorative &amp; Systems</i>							
<b>Venus</b>  p. 380-385 <i>Technical</i>							
<b>Vicky</b> p. 306-313 <i>Decorative</i>							
<b>Zen</b>  p. 386-395 <i>Technical</i>							



**DECORATIVE**

—

# AÉROSTAT

—

Guillaume Delvigne









## CONCEPT

---

Il giovane designer Guillaume Delvigne ha firmato questa serie di lampade decorative in vetro soffiato bianco lucido. Come per il principio dell'aerostato che è quello di rendere un oggetto più leggero dell'aria, anche Delvigne ha pensato ad una lampada come ad un oggetto luminoso, così lieve da potersi elevare rispetto al suolo. Ugualmente le lampade da tavolo e da terra, sebbene trattenute a terra da una base metallica che ricorda una gabbia, mostrano la stessa aspirazione a raggiungere lo spazio sovrastante, allo stesso modo le sospensioni con base metallica. L'eleganza e la semplicità di queste lampade le rende adatte ad ogni tipo di ambiente.

The young designer Guillaume Delvigne is the talented creator of this collection of decorative lamps made out of shiny white blown glass. For Delvigne the inspiration came from the principle of the Aerostat, to make an object that is lighter than air. With this in mind, he conceives a lamp as a luminous object that is so light it can lift itself off the ground. Although the table and floor lamps have a metallic base that resembles a cage, they still seem to reach out into the space above them, in the same way that the ceiling lamps, with a metallic base, reach out below. The sheer elegance and simplicity of these lamps make them suitable for any setting.

El joven diseñador Guillaume Delvigne ha firmado esta serie de lámparas decorativas de vidrio soplado blanco brillante. Al igual que sucede con el principio del aerostato, lograr que un objeto pese menos que el aire, Delvigne también ha pensado en una lámpara como en un objeto luminoso, tan ligero que consigue elevarse del suelo. Lo mismo les ocurre a las lámparas de sobremesa y de pie, que aunque retenidas en el suelo mediante una base metálica, que nos recuerda una jaula, muestran la misma aspiración de alcanzar el espacio superior como las lámparas colgantes con base metálica. Con su elegancia y sencillez, estas lámparas son idóneas para todos los ambientes.

Aus der Hand des jungen Designers Guillaume Delvigne stammt diese dekorative Lampenserie aus mundgeblasenem glänzendem weißem Glas. Gemäß dem Luftballonprinzip, welches ein Objekt leichter als Luft macht, hat auch Delvigne eine Lampe als einen leuchtenden Gegenstand konzipiert, der so leicht ist, dass er sich vom Erdboden abhebt. Dasselbe gilt auch für die Tisch- und Bodenlampen, auch wenn diese am Boden von einer Metallbasis gehalten werden, die an einen Käfig erinnert und das Bestreben verdeutlichen, den oberen Bereich zu erreichen, wie es auch die Hängelampen mit Metallbasis tun. Die Eleganz und Einfachheit dieser Lampen machen sie für jede Umgebung geeignet.

Le jeune designer Guillaume Delvigne a signé cette série de lampes décoratives en verre soufflé blanc poli. A l'instar du principe de l'aérostato qui est celui de rendre un objet plus léger que l'air, la lampe créée par Delvigne est devenue un objet lumineux, si léger qu'il semble s'élever du sol. De la même manière, les lampes de table et de sol, maintenues au sol par une base métallique évoquant une cage, montrent cette même tendance en se développant en hauteur dans l'espace. L'élégance et la simplicité de ces lampes s'adaptent à tout type de contexte.

Молодой дизайнер Гийом Делвинь создал эту серию декоративных ламп из выдувного стекла глянцево-белого цвета. Черпая вдохновение в воздушном шаре, который в полете легче, чем воздух, Делвинь создал эти лампы как яркие и такие легкие объекты, что кажется, они вот-вот поднимутся в небо. Как настольные, так и напольные лампы, хотя они и держатся на металлическом каркасе в форме клетки, все равно передают нам их стремление вознестись ввысь вместе с металлическим основанием. Утонченность и простота этих ламп позволяют использовать их в любом пространстве.

# AÉROSTAT

La collezione Aérostat si compone di due tipologie di sospensioni: una versione composta da solo vetro soffiato in tre dimensioni diverse e montatura bianca; e una versione disponibile in due misure di vetro soffiato e una gabbia metallica che funge da supporto. Le versioni da parete e soffitto sono di tre diverse misure; mentre le lampade da tavolo e a pavimento possono avere due dimensioni diverse di vetri e gabbie. Il vetro è soffiato bianco lucido, mentre le gabbie metalliche sono disponibili nei colori ottone, cromo nero e rame, tutti lucidi. L'elettrificazione è a tensione di rete per lampade alogene, fluorescenti e LED.

La colección Aérostat se compone de dos tipos de suspensiones: una versión consiste en sólo vidrio soplado en tres tamaños distintos y montura blanca; y una versión disponible en dos medidas de vidrio soplado y una jaula metálica que actúa como soporte. Las versiones de pared y de techo vienen en tres tamaños distintos; mientras que las lámparas de mesa y suelo pueden tener dos tamaños diferentes de cristal y jaula. El cristal es soplado y blanco brillante, mientras que la jaula metálica están disponibles en color latón, cromo negro y cobre, todos brillantes. La electrificación es el voltaje de red para lámparas halógenas, fluorescentes y LED.

Die Kollektion Aérostat besteht aus zwei unterschiedlichen Lampenformen: Eine besteht aus mundgeblasenem Glas in drei unterschiedlichen Größen und einem weißen Rahmen, die andere besteht ebenfalls aus mundgeblasenem Glas, ist jedoch sozusagen in einem Metallkäfig eingeschlossen. Die Wand- und Deckenleuchten gibt es in drei verschiedenen Größen, die Tisch- und Stehlampen sind in zwei Größen erhältlich. Das geblasene Glas ist glänzend weiß. Die Metallkäfige sind in Messing, schwarz, Chrom und kupferfarben erhältlich. Die Leuchten werden an das normale Stromnetz angeschlossen und funktionieren mit Halogenlampen, Leuchtstofflampen und LED-Lampen.

The Aérostat collection is composed of two different versions of pendant lamps: one is composed of only glass (available in three different sizes) and metal support; whereas the other one is composed of glass, metal support and a decorative metal cage. The wall and ceiling lamps are available in three different sizes; whereas the table and floor lamps are available in two different sizes of glass and metal cage. All diffusers are in shiny white blown glass whereas the metal cages are in brass, black chrome and copper finish, all shiny. The lamp runs on mains power and is suitable for use with halogen, fluorescent and LED bulbs.

La collection Aérostat se compose de deux types de suspensions: une version composée uniquement de verre soufflé en trois tailles différentes avec une monture blanche; et une version disponible dans deux dimensions en verre soufflé et avec une structure métallique qui fait office de support. Les versions murales et plafonniers sont disponibles en trois tailles différentes; tandis que les lampes de table et de sol sont disponibles en deux tailles différentes de verre et de structures. Le verre soufflé est blanc brillant, tandis que les structures en métal sont disponibles en laiton, chrome noir et cuivre, tous brillants. Ampoules halogènes, fluorescentes et LED alimentées par la tension du réseau.

Коллекция Aérostat состоит из подвесок двух типов: версия, состоящая только из выдувного стекла в трех различных размерах и с белой оправой; и версия, доступная с выдувным стеклом в двух размерах и с металлической клеткой, выступающей в качестве основы. Версии для стен и потолка бывают в трех различных размерах, в то время как для настольных и напольных ламп предлагаются два размера стекла и клетки. Стекло — выдувное, белое, блестящее, в то время как металлические клетки доступны в цвете латуни, хромированном черном и цвете меди — все блестящие. Электрификация от сети с использованием галогенных, люминесцентных и светодиодных ламп.



**AÉROSTAT**  
Guillaume Delvigne

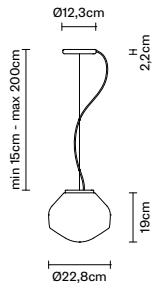

**code**

**electrification**

**technical info**

**accessories**

**F27 A01**  
01 White

LED 220-240V  
1x8.7W-120°  
WHITE 3000K  
800lm Cri >80



**EAC** IP20  
0,027 m<sup>3</sup>  
2,18 kg

INCLUDED:  
- LED / LED  
- Kit per decentramento / *Off-center cable fastener*

Dimmerabile TRIAC / *Dimmable TRIAC*

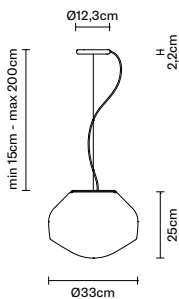

**F27 A07**  
01 White

E27 220-240V  
1x150W HSGST



**EAC** IP20  
0,071 m<sup>3</sup>  
3,89 kg

INCLUDED:  
- Kit per decentramento / *Off-center cable fastener*

E27 220-240V  
1x15W FBG



NOT INCLUDED:  
- Lampadina / *Bulb*

**F27 A03**  
01 White

LED 220-240V  
1x17W-120°  
WHITE 3000K  
1850lm Cri >80



**EAC** IP20  
0,071 m<sup>3</sup>  
5,36 kg

INCLUDED:  
- LED / LED  
- Kit per decentramento / *Off-center cable fastener*

Dimmerabile TRIAC / *Dimmable TRIAC*

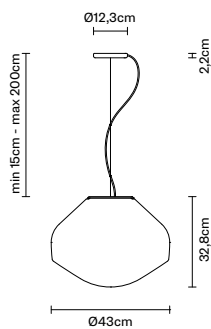

**F27 A09**  
01 White

E27 220-240V  
1x205W HSGST



**EAC** IP20  
0,122 m<sup>3</sup>  
4,74 kg

INCLUDED:  
- Kit per decentramento / *Off-center cable fastener*

E27 220-240V  
1x15W FBG



NOT INCLUDED:  
- Lampadina / *Bulb*

**F27 A05**  
01 White

LED 220-240V  
1x17W-120°  
WHITE 3000K  
1850lm Cri >80



**EAC** IP20  
0,122 m<sup>3</sup>  
5,27 kg

INCLUDED:  
- LED / LED  
- Kit per decentramento / *Off-center cable fastener*

Dimmerabile TRIAC / *Dimmable TRIAC*



**AÉROSTAT**  
Guillaume Delvigne

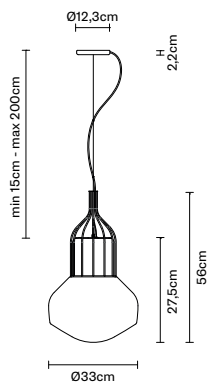

**code**

**electrification**

**technical info**

**accessories**

**F27 A11**

**19** Brass-plated  
**24** Black chrome  
**41** Copper

E27 220-240V  
1x150W HSGST



**EAC** IP20

NOT INCLUDED:  
- Lampadina / Bulb

E27 220-240V  
1x15W FBG

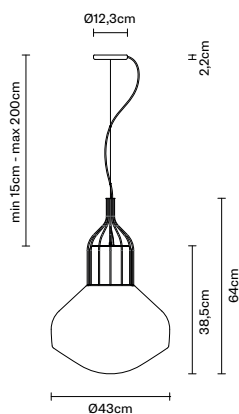

**F27 A13**

**19** Brass-plated  
**24** Black chrome  
**41** Copper

E27 220-240V  
1x150W HSGST



**EAC** IP20

NOT INCLUDED:  
- Lampadina / Bulb

E27 220-240V  
1x30W FBT

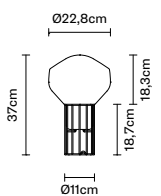

**F27 B01**

**19** Brass-plated  
**24** Black chrome  
**41** Copper

E14 220-240V  
1x46W HSGSB



**EAC** IP20  
0,027 m<sup>3</sup>  
2,27 kg

NOT INCLUDED:  
- Lampadina / Bulb

E14 220-240V  
1x11W FBT

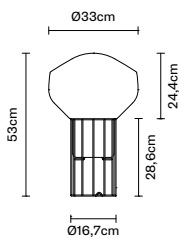

**F27 B03**

**19** Brass-plated  
**24** Black chrome  
**41** Copper

E27 220-240V  
1x150W HSGST



**EAC** IP20  
0,106 m<sup>3</sup>  
5,57 kg

NOT INCLUDED:  
- Lampadina / Bulb

E27 220-240V  
1x30W FBT





**AÉROSTAT**  
Guillaume Delvigne

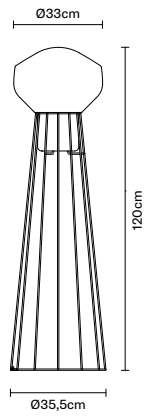

**code**

**electrification**

**technical info**

**accessories**

**F27 C01**

**19** Brass-plated  
**24** Black chrome  
**41** Copper

E27 220-240V  
1x150W HSGST



**EAC**  IP20

NOT INCLUDED:  
- Lampadina / Bulb

E27 220-240V  
1x15W FBG

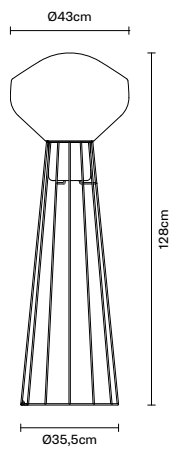

**F27 C03**

**19** Brass-plated  
**24** Black chrome  
**41** Copper

E27 220-240V  
1x150W HSGST



**EAC**  IP20

NOT INCLUDED:  
- Lampadina / Bulb

E27 220-240V  
1x30W FBT







**AÉROSTAT**  
Guillaume Delvigne

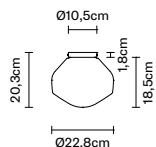

**code**

**electrification**

**technical info**

**accessories**

**F27 G01**  
01 White

LED 220-240V  
1x8.7W-120°  
WHITE 3000K  
800lm Cri >80



**EAC** IP40  
0,027 m<sup>3</sup>  
1,60 kg



INCLUDED:  
- LED / LED

Dimmerabile TRIAC / Dimmable TRIAC

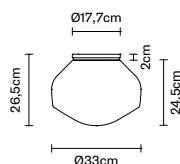

**F27 G07**  
01 White

E27 220-240V  
1x150W HSGST



**EAC** IP40  
0,071 m<sup>3</sup>  
2,51 kg

NOT INCLUDED:  
- Lampadina / Bulb

E27 220-240V  
1x15W FBG



**F27 G03**  
01 White

LED 220-240V  
1x17W-120°  
WHITE 3000K  
1850lm Cri >80



**EAC** IP40  
0,071 m<sup>3</sup>  
3,86 kg



INCLUDED:  
- LED / LED

Dimmerabile TRIAC / Dimmable TRIAC

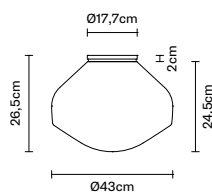

**F27 G09**  
01 White

E27 220-240V  
1x150W HSGST



**EAC** IP40  
0,122 m<sup>3</sup>  
6,04 kg

NOT INCLUDED:  
- Lampadina / Bulb

E27 220-240V  
1x30W FBT



**F27 G05**  
01 White

LED 220-240V  
1x17W-120°  
WHITE 3000K  
1850lm Cri >80



**EAC** IP40  
0,122 m<sup>3</sup>  
4,13 kg



INCLUDED:  
- LED / LED

Dimmerabile TRIAC / Dimmable TRIAC

# BELUGA



Marc Sadler







# CONCEPT

---

L'obiettivo presentato a Marc Sadler era quello di progettare una collezione di lampade orientabili, eclettiche semplici. Nasce così Beluga, famosa per l'inconfondibile design tecnico ed essenziale che si ispira al concetto atomico. Il designer studia l'essenza della materia, la dinamica al suo interno e soprattutto le particelle che la formano. Ne estrae quindi gli elementi, protoni neutroni ed elettroni per permettere di creare nella realtà delle interconnessioni e composizioni fantasiose, rese ancora più libere e versatili grazie all'uso di diversi colori e materiali. I diffusori di Beluga sono infatti disponibili in cristallo (trasparente, bianco, rosso, giallo, marrone, verde e blu) e in metallo.

The objective facing Marc Sadler was that of designing a collection of eclectic, simple adjustable lamps. He thus came up with the Beluga spotlight with its unique technical, essential design inspired by the atom. To create this lamp, the designer studied the atom itself, its nucleus and above all the particles which form it. He then took the elements, protons, neutrons and electrons to create patterns and layouts for real use, made even more free and versatile thanks to the use of different colours and materials. The diffusers of the Beluga lamps are in fact available in crystal (transparent, white, red, yellow, brown, green and blue) or metal.

Para Marc Sadler, el objetivo era diseñar una colección de lámparas orientables, eclécticas y sencillas. Así es como nace Beluga, famosa por el diseño técnico inconfundible y esencial, que se inspira en el concepto atómico. El diseñador estudia la esencia de la materia, la dinámica interna y, sobre todo, las partículas que la componen. Luego extrae de ellas los elementos, protones, neutrones y electrones para crear en la realidad interconexiones y composiciones fantasiosas, que resultan más libres y versátiles mediante el uso de distintos colores y materiales. Los difusores de Beluga existen en cristal (transparente, blanco, rojo, amarillo, marrón, verde y azul) y metal.

Das Marc Sadler präsentierte Ziel war, eine Kollektion aus ausrichtbaren, eklektischen und einfachen Lampen zu entwickeln. So entstand Beluga, für ihr unvergleichbares technisches und essentielles Design berühmt, das sich am atomischen Konzept inspiriert. Der Designer studierte die Essenz der Materie, die Dynamik in ihr und vor allem die Partikel, die sie bilden. Er entnahm somit ihre Elemente, Protonen, Neutronen und Elektronen, um in der Realität phantasiereiche Verbindungen und Zusammensetzungen zu bilden, die dank der Anwendung verschiedener Farben und Materialien noch freier und vielseitiger gestaltet wurden. Die Diffusoren von Beluga sind effektiv in Kristallglas (transparent, weiß, rot, gelb, braun, grün und blau) sowie aus Metall erhältlich.

L'objectif présenté à Marc Sadler était celui de concevoir une collection de lampes orientables, simples et universelles. C'est ainsi qu'est née la série Beluga, connue pour son design technique caractéristique et essentiel qui s'inspire du concept atomique. Le designer étudie l'essence de la matière, sa dynamique intérieure et, surtout, les particules qui la forment. Il extrait ensuite ses éléments, protons, neutrons et électrons, en vue de matérialiser librement des interconnexions et des compositions originales, encore plus universelles avec l'usage de couleurs et de matériaux différents. En effet, les diffuseurs de la série Beluga sont disponibles en cristal (transparent, blanc, rouge, jaune, marron, vert et bleu) et en métal.

Дизайнер Марк Садлер задался целью создать коллекцию регулируемых, эклектических и простых ламп. Творение дизайнера – Белуга – известно своим неповторимым дизайном в стиле техно-экзистенциализма и заимствует идею в концепции атома. Дизайнер изучает эссенцию материи, ее динамику и, в особенности, ее составляющие частицы. Он извлекает ее элементы, протоны, нейтроны и электроны, чтобы в реальности воссоздать взаимосвязи и причудливые композиции, еще более свободные и разносторонние, благодаря использованию различных материалов и цветов. Лампы Белуга выполнены из кристалла (прозрачного, белого, красного, желтого, коричневого, зеленого и синего цветов) и из металла.

# BELUGA

---

La collezione è composta da sospensioni, lampade da tavolo, terra, parete, soffitto e binario per interno ed esterno. I diffusori sferici, orientabili e ruotanti, sono di diverse dimensioni e materiali: cristallo trasparente o verniciati, cromo lucido o vetro soffiato bianco lucido. Le strutture metalliche sono tutte in cromo lucido. La versione da terra per esterno ha una struttura in fusione di alluminio con finitura lucida o verniciata nera. Elettrificazione a tensione di rete per lampade alogene e LED.

La colección está compuesta por lámparas colgantes, lámparas de sobremesa, de pie, apliques, plafones y regletas de interior y exterior. Los difusores esféricos, orientables y rotativos, son de distintas medidas y materiales: cristal transparente o pintado, cromo brillante o vidrio soplado blanco brillante. Todas las estructuras metálicas son de cromo brillante. La versión de pie para el exterior presenta una estructura de fusión de aluminio con un acabado brillante o pintado de color negro. Electrificación con tensión de red para bombillas halógenas y LED.

Die Kollektion besteht aus Hänge-, Tisch-, Boden-, Wand-, Decken- und Schienenlampen für innen und außen. Die kugelförmigen, ausrichtbaren und drehenden Diffusoren weisen verschiedene Abmessungen und Material auf: Transparentes oder lackiertes Kristallglas, glanzverchromt oder weißes, glänzendes geblasenes Glas. Die Metallstrukturen sind alle glanzverchromt. Die Bodenausführung für außen weist eine Alugussstruktur mit Glanz- oder Schwarzlackausführung auf. Die Elektrifizierung erfolgt über Netzspannung bei Halogen- und LED-Lampen.

The collection is made up of hanging, table, floor, wall and ceiling lamps, in addition to a series of lamps mounted on a track. They are suitable for both indoor and outdoor use. The spherical diffusers rotate to any position and are available in different sizes and materials: transparent or painted crystal, polished chrome or shiny white blown glass. All metallic structures are in polished chrome. The floor lamp variant for outdoor use has a structure in cast aluminium with a shiny or black painted finish. The lamp runs on mains power and is suitable for use with halogen and LED bulbs.

La collection est composée de suspensions, de lampes de table, de lampadaires, d'appliques murales, de plafonniers et de rails pour intérieur et extérieur. Les diffuseurs sphériques, orientables et rotatifs sont proposés en plusieurs matériaux et dimensions: cristal transparent ou peint, chrome poli ou verre soufflé poli. Les structures métalliques sont toutes réalisées en chrome poli. La version lampadaire pour extérieur possède une structure en alliage d'aluminium poli ou verni noir. Lampes halogènes et LED alimentées par la tension du réseau.

Коллекция состоит из подвесных, настольных, напольных, настенных, потолочных и трековых ламп для внутренних помещений и открытых пространств. Сферические лампы, регулируемые и вращающиеся, предоставлены в различных размерах и материалах: из прозрачного кристалла, с лаковым покрытием, с хромовым покрытием или из выдутого стекла глянцево-белого цвета. Все металлические структуры выполнены из хрома с глянцевым покрытием. Напольная лампа для наружного оформления имеет структуру из алюминиевого сплава с глянцевым покрытием или с черным лаковым покрытием. Электрическая часть рассчитана на галогеновую и светодиодную лампу от сетевого напряжения.



**BELUGA COLOUR**

Marc Sadler



**code**

**electrification**

**technical info**

**accessories**

**D57 A11**  
**00 Transparent**  
**03 Red**  
**04 Yellow**  
**31 Blue**  
**41 Copper**  
**43 Green**

GU10 220-240V  
 1x75W HAGS/UB



GU10 220-240V  
 1x5,5W



0,02 m<sup>3</sup>  
 3,05 kg



NOT INCLUDED:  
 - Lampadina / Bulb

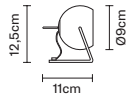

**D57 B03**  
**00 Transparent**  
**03 Red**  
**04 Yellow**  
**31 Blue**  
**41 Copper**  
**43 Green**

GU10 220-240V  
 1x50W HAGS/UB



GU10 220-240V  
 1x5,5W

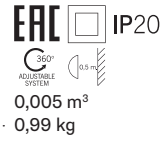

0,005 m<sup>3</sup>  
 0,99 kg



NOT INCLUDED:  
 - Lampadina / Bulb

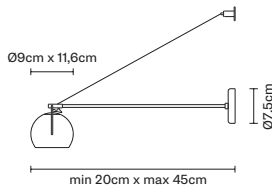

**D57 D03**  
**00 Transparent**  
**03 Red**  
**04 Yellow**  
**31 Blue**  
**41 Copper**  
**43 Green**

GU10 220-240V  
 1x75W HAGS/UB



GU10 220-240V  
 1x5,5W



0,01 m<sup>3</sup>  
 2,00 kg



NOT INCLUDED:  
 - Lampadina / Bulb

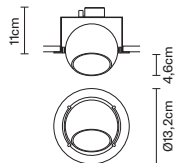

**D57 F01**  
**00 Transparent**  
**03 Red**  
**04 Yellow**  
**31 Blue**  
**41 Copper**  
**43 Green**

GU10 220-240V  
 1x75W HAGS/UB



GU10 220-240V  
 1x5,5W

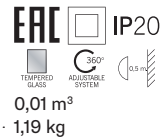

0,01 m<sup>3</sup>  
 1,19 kg



NOT INCLUDED:  
 - Lampadina / Bulb





**BELUGA COLOUR**

Marc Sadler

**code**      **electrification**      **technical info**      **accessories**

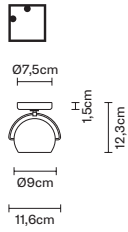

**D57 G13**  
**00** Transparent  
**03** Red  
**04** Yellow  
**31** Blue  
**41** Copper  
**43** Green

GU10 220-240V  
 1x75W HAGS/UB  
  
 GU10 220-240V  
 1x5,5W

**EAC** **IP20**  
  
 0,005 m<sup>3</sup>  
 0,95 kg

NOT INCLUDED:  
 - Lampadina / Bulb

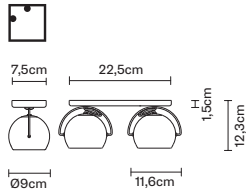

**D57 G23**  
**00** Transparent  
**03** Red  
**04** Yellow  
**31** Blue  
**41** Copper  
**43** Green

GU10 220-240V  
 2x75W HAGS/UB  
  
 GU10 220-240V  
 2x5,5W

**EAC** **IP20**  
  
 0,009 m<sup>3</sup>  
 1,94 kg

NOT INCLUDED:  
 - Lampadina / Bulb

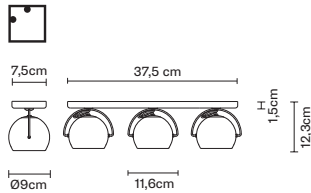

**D57 G25**  
**00** Transparent  
**03** Red  
**04** Yellow  
**31** Blue  
**41** Copper  
**43** Green

GU10 220-240V  
 3x75W HAGS/UB  
  
 GU10 220-240V  
 3x5,5W

**EAC** **IP20**  
  
 0,014 m<sup>3</sup>  
 2,95 kg

NOT INCLUDED:  
 - Lampadina / Bulb

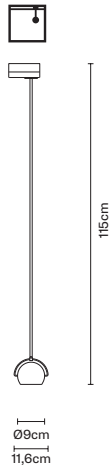

**D57 J05**  
**00** Transparent  
**03** Red  
**04** Yellow  
**31** Blue  
**41** Copper  
**43** Green

GU10 220-240V  
 1x75W HAGS/UB  
  
 GU10 220-240V  
 1x5,5W

**EAC** **IP20**  
  
 0,035 m<sup>3</sup>  
 2,01 kg

NOT INCLUDED:  
 - Lampadina / Bulb  
 - Binario / Track

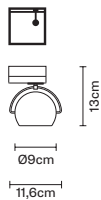

**D57 J07**  
**00** Transparent  
**03** Red  
**04** Yellow  
**31** Blue  
**41** Copper  
**43** Green

GU10 220-240V  
 1x75W HAGS/UB  
  
 GU10 220-240V  
 1x5,5W

**EAC** **IP20**  
  
 0,005 m<sup>3</sup>  
 0,93 kg

NOT INCLUDED:  
 - Lampadina / Bulb  
 - Binario / Track



**BELUGA STEEL**

Marc Sadler

*code*

*electrification*

*technical info*

*accessories*

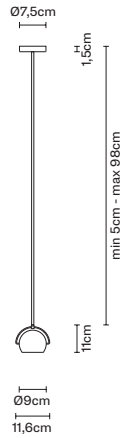

**D57 A05**  
15 Chrome

GU10 220-240V  
1x75W HAGS/UB



IP20

NOT INCLUDED:  
- Lampadina / Bulb

GU10 220-240V  
1x5,5W



LED



**D57 A07**  
15 Chrome

E27 220-240V  
1x100W HAGS/UB



IP20

NOT INCLUDED:  
- Lampadina / Bulb

E27 220-240V  
1x9,5W



LED



**D57 A09**  
15 Chrome

E27 220-240V  
1x205W HSGST



IP20

NOT INCLUDED:  
- Lampadina / Bulb

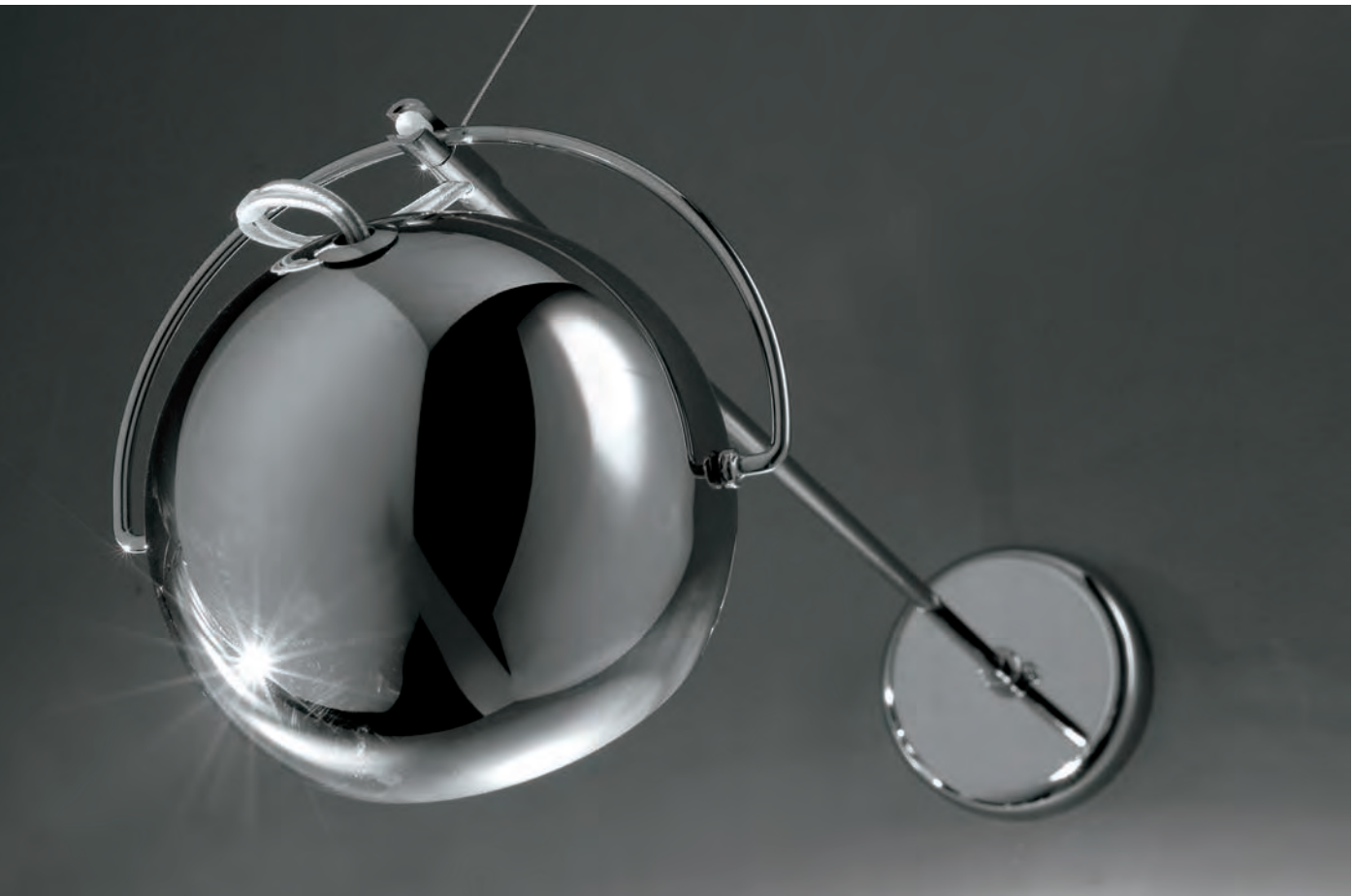
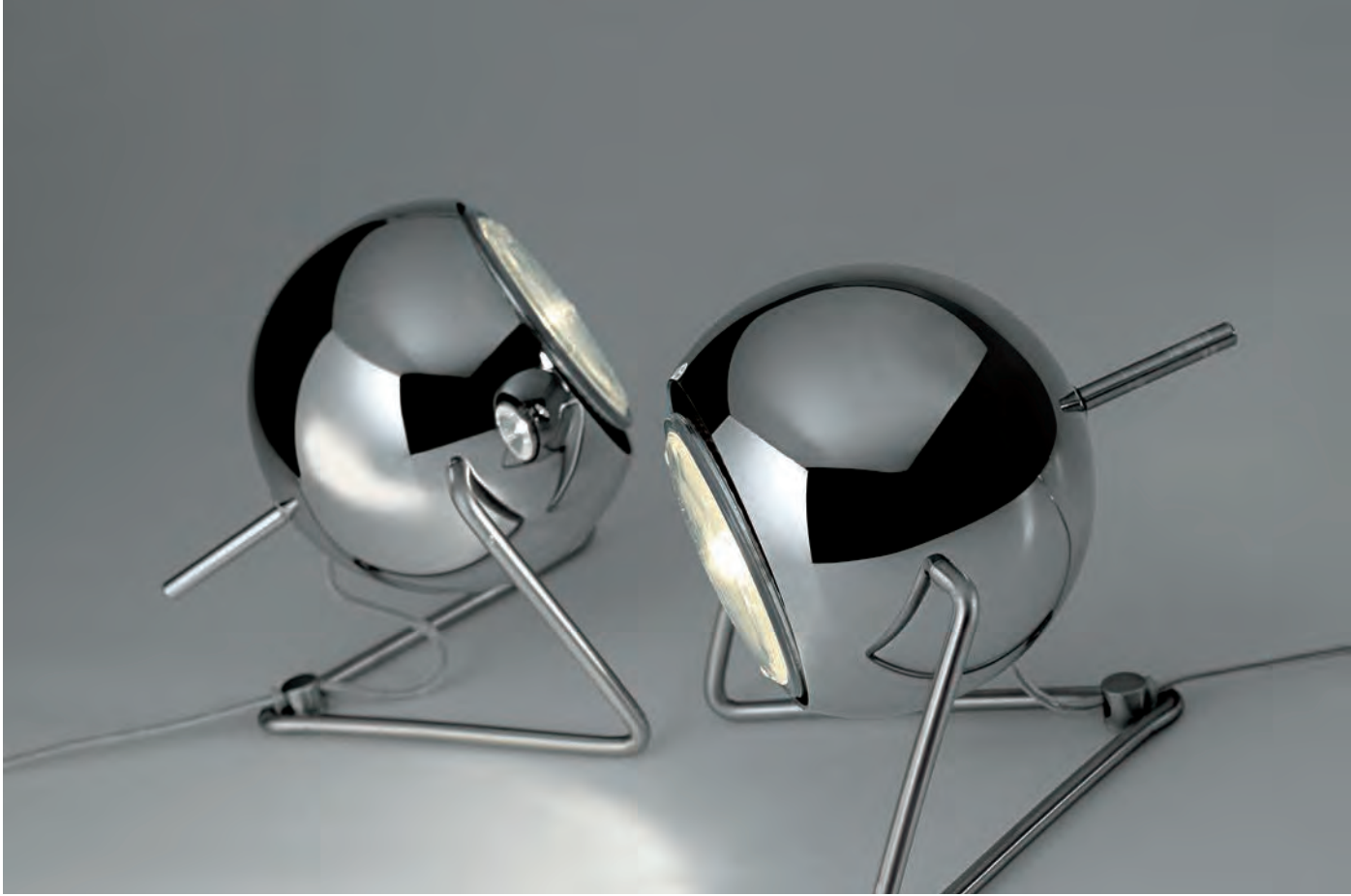

**BELUGA STEEL**

Marc Sadler

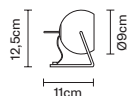

**code**

**electrification**

**technical info**

**accessories**

**D57 B05**  
15 Chrome

GU10 220-240V  
1x50W HAGS/UB



**EAC**  **IP20**



0,005 m<sup>3</sup>  
0,58 kg

NOT INCLUDED:  
- Lampadina / *Bulb*

GU10 220-240V  
1x5,5W

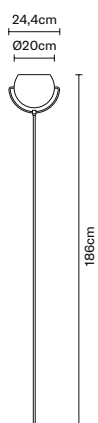

**D57 C01**  
15 Chrome

E27 220-240V  
1x205W HSGST



**EAC**  **IP20**



0,245 m<sup>3</sup>  
11,22 kg

NOT INCLUDED:  
- Lampadina / *Bulb*  
- Variatore di luce / *Light dimmer*

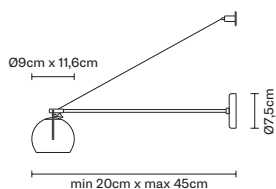

**D57 D05**  
15 Chrome

GU10 220-240V  
1x75W HAGS/UB



**EAC**  **IP20**



0,01 m<sup>3</sup>  
1,46 kg

NOT INCLUDED:  
- Lampadina / *Bulb*

GU10 220-240V  
1x5,5W





**BELUGA STEEL**

Marc Sadler

*code*

*electrification*

*technical info*

*accessories*

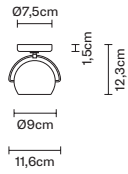

**D57 G11**  
15 Chrome

GU10 220-240V  
1x75W HAGS/UB



GU10 220-240V  
1x5,5W



0,005 m<sup>3</sup>  
0,42 kg



NOT INCLUDED:  
- Lampadina / Bulb

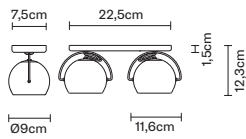

**D57 G19**  
15 Chrome

GU10 220-240V  
2x75W HAGS/UB



GU10 220-240V  
2x5,5W



0,014 m<sup>3</sup>  
0,89 kg



NOT INCLUDED:  
- Lampadina / Bulb

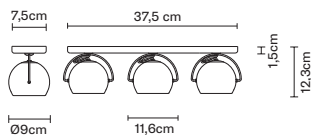

**D57 G21**  
15 Chrome

GU10 220-240V  
3x75W HAGS/UB



GU10 220-240V  
3x5,5W



0,014 m<sup>3</sup>  
1,39 kg



NOT INCLUDED:  
- Lampadina / Bulb

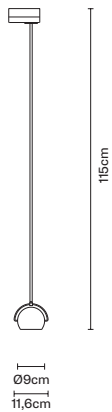

**D57 J01**  
15 Chrome

GU10 220-240V  
1x75W HAGS/UB



GU10 220-240V  
1x5,5W



0,035 m<sup>3</sup>  
1,48 kg



NOT INCLUDED:  
- Lampadina / Bulb  
- Binario / Track

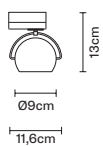

**D57 J03**  
15 Chrome

GU10 220-240V  
1x75W HAGS/UB



GU10 220-240V  
1x5,5W



0,005 m<sup>3</sup>  
0,39 kg



NOT INCLUDED:  
- Lampadina / Bulb  
- Binario / Track





**BELUGA WHITE**

Marc Sadler

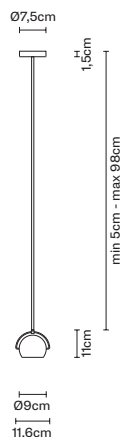

**code**

**electrification**

**technical info**

**accessories**

**D57 A17**  
01 White

G9 220-240V  
1x48W HSGS



**EAC**  **IP20**  
360°  
ADJUSTABLE SYSTEM  
0,02 m<sup>3</sup>  
3,05 kg

NOT INCLUDED:  
- Lampadina / Bulb

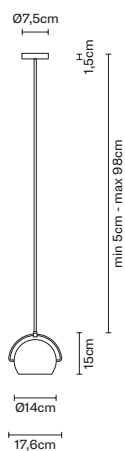

**D57 A19**  
01 White

G9 220-240V  
1x60W HSGS



**EAC**  **IP20**  
360°  
ADJUSTABLE SYSTEM  
0,098 m<sup>3</sup>  
1,92 kg

NOT INCLUDED:  
- Lampadina / Bulb



**D57 A21**  
01 White

E27 220-240V  
1x150W HSGST



**EAC**  **IP20**  
360°  
ADJUSTABLE SYSTEM  
0,098 m<sup>3</sup>  
2,36 kg

NOT INCLUDED:  
- Lampadina / Bulb

E27 220-240V  
1x15W FBG





**BELUGA WHITE**

Marc Sadler

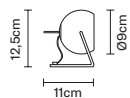

**code**

**electrification**

**technical info**

**accessories**

**D57 B07**  
01 White

G9 220-240V  
1x20W HSGS



NOT INCLUDED:  
- Lampadina / Bulb

0,005 m<sup>3</sup>  
0,99 kg

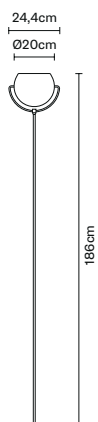

**D57 C11**  
01 White

E27 220-240V  
1x150W HSGST

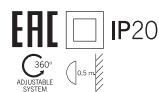

NOT INCLUDED:  
- Lampadina / Bulb  
- Variatore di luce / Light dimmer

0,245 m<sup>3</sup>  
11,45 kg

E27 220-240V  
1x15W FBG

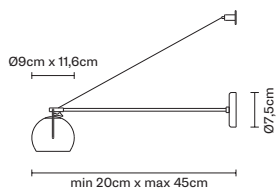

**D57 D07**  
01 White

G9 220-240V  
1x48W HSGS



NOT INCLUDED:  
- Lampadina / Bulb

0,01 m<sup>3</sup>  
1,97 kg



**BELUGA WHITE**

Marc Sadler

**code**

**electrification**

**technical info**

**accessories**

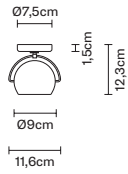

**D57 G27**  
01 White

G9 220-240V  
1x48W HSGS



**EAC**  **IP20**  
360°  
ADJUSTABLE SYSTEM  
0,005 m<sup>3</sup>  
1,00 kg

NOT INCLUDED:  
- Lampadina / Bulb

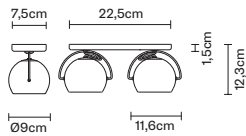

**D57 G29**  
01 White

G9 220-240V  
2x48W HSGS



**EAC**  **IP20**  
360°  
ADJUSTABLE SYSTEM  
0,009 m<sup>3</sup>  
0,99 kg

NOT INCLUDED:  
- Lampadina / Bulb

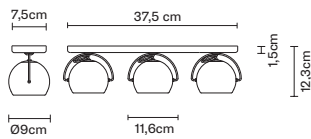

**D57 G31**  
01 White

G9 220-240V  
3x48W HSGS



**EAC**  **IP20**  
360°  
ADJUSTABLE SYSTEM  
0,014 m<sup>3</sup>  
0,93 kg

NOT INCLUDED:  
- Lampadina / Bulb

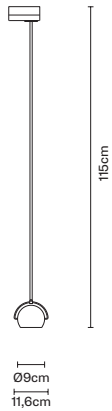

**D57 J13**  
01 White

G9 220-240V  
1x48W HSGS



**EAC**  **IP20**  
360°  
ADJUSTABLE SYSTEM  
0,035 m<sup>3</sup>  
2,08 kg

NOT INCLUDED:  
- Lampadina / Bulb  
- Binario / Track

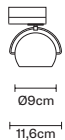

**D57 J15**  
01 White

G9 220-240V  
1x48W HSGS



**EAC**  **IP20**  
360°  
ADJUSTABLE SYSTEM  
0,005 m<sup>3</sup>  
0,83 kg

NOT INCLUDED:  
- Lampadina / Bulb  
- Binario / Track

# BELUGA ROYAL

Marc Sadler









# CONCEPT

---

Come perle iridescenti, le sospensioni della collezione Beluga Royal risaltano grazie alla propria luce e alla luce riflessa dell'ambiente circostante. Preziose, grazie alle ricche finiture metalliche, il loro aspetto viene esaltato da ciò che le circonda, mutandone i colori, i riflessi e plasmandone le forme. Una volta accese, invece, le sospensioni diventano indiscusse protagoniste dello spazio definendolo attraverso i giochi di luce creati dal corpo luminoso. Dallo stile un po' retrò, le sospensioni Beluga Royal arricchiscono gli ambienti dove sono collocate.

As iridescent pearls, Beluga Royal collection hanging lamps stand out thanks to their light and to the light reflected from the surrounding environment. With precious metal finishes, their look is accented by their surroundings, with changing colours and glares and mutating shapes. Once they are turned on, these hanging lamps become the stars of any room, defining through the light effects created by the luminous unit. Vintage-style Beluga Royal hanging lights enrich all the rooms with their presence.

Al igual que perlas iriscentes, las lámparas colgantes de la colección Beluga Royal resaltan por la luz propia y la luz reflejada del ambiente circundante. Son preciosas con sus ricos acabados metálicos; el aspecto de éstas se exalta por lo que las rodea, cambiando sus colores, los reflejos y plasmando sus formas. Sin embargo, las lámparas colgantes encendidas se convierten en las protagonistas indiscutibles del espacio y lo definen mediante juegos de luz creados por el cuerpo luminoso. Con un estilo algo retrò, las lámparas colgantes Beluga Royal enriquecen los ambientes donde se instalan.

Die Deckenlampen der Kollektion Beluga Royal gleichen schillernden Perlen, die von innen heraus leuchten und das Licht des Ambientes widerspiegeln. Die Leuchten zeigen ein aufwändiges Metallfinish, das ihnen eine kostbare Note verleiht und verschöner den umgebenden Bereich, indem sie dessen Farben, Reflexe und Formen verwandeln. Sobald sie jedoch angeschaltet werden, sind sie unumstrittener Blickfang des Raums, den sie mit den Lichtakzenten des Leuchtkörpers gestalten. Die Hängelampen Beluga Royal mit ihrem schlichten Retro-Stil bereichern jedes Interieur.

Comme des perles iriscentes, les suspensions de la collection Beluga Royal ressortent grâce à leur lumière et à la lumière reflétée par l'environnement. Précieuses, grâce aux finitions métalliques, leur aspect est exalté par tout ce qui les entoure, en transformant leurs couleurs, leurs reflets et en modelant leurs formes. Dès qu'elles sont allumées, les suspensions deviennent indiscutablement les protagonistes de l'espace en le définissant à travers des jeux de lumière créés par le corps d'éclairage. Avec leur style un peu retrò, les suspensions Beluga Royal enrichissent les espaces où elles sont placées.

Как радужный жемчуг, подвесные лампы коллекции Beluga Royal сияют собственным и отраженным от окружающего их помещения светом. Драгоценный вид богатого металлического покрытия еще больше превозносится в окружении, меняя цвета, отражения и формы ламп. Когда лампы горят, подвесная конструкция становится главным объектом в пространстве, которое она создает игрой собственного света. Стиль ретро, в котором выполнены лампы Beluga Royal, обогащают помещения, в которых они установлены.

# BELUGA ROYAL

La collezione Beluga Royal è composta da una serie di sospensioni sferiche, di diversi diametri, in vetro soffiato trasparente. Le particolari finiture dei vetri sono dovute a un processo di metallizzazione dorata, bronzo e titanio. Infatti, se spente, le sospensioni hanno un effetto specchiato; mentre, quando sono accese, si intravede la sorgente luminosa a LED mascherata da un diffusore interno in policarbonato e un supporto in alluminio che crea un gioco di riflessi luminosi. La diffusione della luce è quasi esclusivamente diretta.

Una serie de lámparas colgantes esféricas, con distintos diámetros, de vidrio soplado transparente, compone la colección Beluga Royal. Los acabados peculiares de los vidrios son el fruto de un proceso metalizado en dorado, bronce y titanio. De hecho, las lámparas colgantes apagadas presentan un efecto de espejo; mientras que, encendidas, se vislumbra la fuente luminosa de LED, oculta mediante un difusor interior de policarbonato y un soporte de aluminio, que crea juegos de reflejos luminosos. La difusión de la luz es casi exclusivamente directa.

Die Kollektion Beluga Royal umfasst kugelförmige Hängelampen mit unterschiedlichem Durchmesser aus geblasenem, transparentem Glas. Das besondere Finish des Glases entsteht dank einer Metallisierung mit Gold, Bronze und Titan. Deshalb haben die Hängeleuchten, wenn sie ausgeschaltet sind, eine Spiegelwirkung, und lassen eingeschaltet das Licht der LED-Leuchten erahnen, das von einem eingebauten Diffusor aus Polykarbonat und einem Halter aus Aluminium getarnt wird, der spielerische Lichtreflexe zaubert. Die Lichtstreuung ist fast ausschließlich direkt.

The Beluga Royal collection comprises round clear blown-glass hanging lamps in different sizes. The peculiar glass finishes are created through golder, bronze and titanium metallization processes. When they are turned off, the lights have a mirrored effect; and when lit, the LED light source can be seen masked by an inner polycarbonate diffuser and an aluminium support, which creates luminous reflective effects. Mainly direct light diffusion.

La collection Beluga Royal est composée par une série de suspensions sphériques, de différents diamètres, en verre soufflé transparent. Les finitions spéciales des verres sont dues à un procédé de métallisation dorée, bronze et sur titane. En effet, si elles sont éteintes, les suspensions ont un effet réfléchissant; alors que lorsqu'elles sont allumées, il est possible d'entrevoir la source lumineuse à LED masquée par un diffuseur interne en polycarbonate et un support en aluminium qui crée un jeu de reflets lumineux. La diffusion de la lumière est quasi exclusivement directe.

Коллекция Beluga Royal состоит из подвесных сфер разных диаметров, из выдувного прозрачного стекла. Особое металлическое покрытие выполнено из золота, бронзы и титана. Когда лампы выключены, они имеют зеркальный эффект. Когда они включены, в плафоне ламп виден светодиод, который как будто бы запрятан под рассеиватель из поликарбоната и алюминиевый кронштейн, создавая эффект игры света. Рассеивание света почти исключительно прямое.



**BELUGA ROYAL**

Marc Sadler

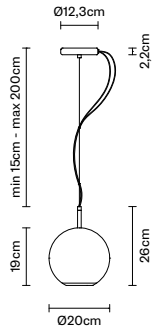

*code*

*electrification*

*technical info*

*accessories*

**D57 A51**

12 Gold  
34 Titanium  
41 Bronze

LED 220-240V  
1x8.7W-120°  
WHITE 3000K  
800lm Cri >80

**EAC** IP40

0,027 m<sup>3</sup>  
2,18 kg

INCLUDED:

- LED / LED  
- Kit per decentramento / *Off-center cable fastener*



Dimmerabile TRIAC / *Dimmable TRIAC*

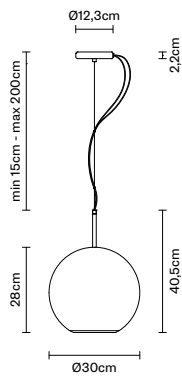

**D57 A53**

12 Gold  
34 Titanium  
41 Bronze

LED 220-240V  
1x17W-120°  
WHITE 3000K  
1850lm Cri >80

**EAC** IP40

0,071 m<sup>3</sup>  
5,36 kg

INCLUDED:

- LED / LED  
- Kit per decentramento / *Off-center cable fastener*



Dimmerabile TRIAC / *Dimmable TRIAC*

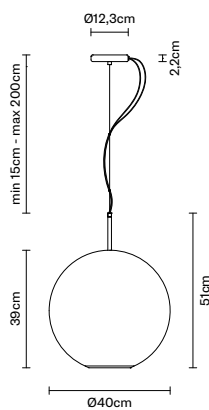

**D57 A55**

12 Gold  
34 Titanium  
41 Bronze

LED 220-240V  
1x17W-120°  
WHITE 3000K  
1850lm Cri >80

**EAC** IP40

0,122 m<sup>3</sup>  
5,27 kg

INCLUDED:

- LED / LED  
- Kit per decentramento / *Off-center cable fastener*



Dimmerabile TRIAC / *Dimmable TRIAC*

# BIJOU

—

Prospero Rasulo







# CONCEPT

---

Come molti designers, anche Prospero Rasulo si è lasciato ispirare delle morbide forme della natura per la progettazione della famiglia di lampade Bijou. Sospensioni che scivolano come gocce dal soffitto, piantane che sembrano sbocciare come fiori, applique sinuose e squadrate che si mostrano padrone della scena grazie ai giochi di luci che sottolineano il loro minimalismo chic. La collezione Bijou è disponibile in metallo verniciato bianco, nero e cromo ed è adatta sia nei contesti di case o strutture private, sia nei locali pubblici.

Like many designers, Prospero Rasulo also took inspiration from the gentle shapes of nature when creating the Bijou lamp range. Pendant lamps that seem to fall from the ceiling like drops of water, standard lamps that appear to blossom like flowers, windy and squared wall lamps that take control of the situation with patterns of light that underline their minimalist chic. The Bijou collection is available in metal painted white or with a chrome finish and is suitable for use in both the home and other private structures or public buildings.

Al igual que numerosos diseñadores, también Prospero Rasulo se ha dejado inspirar por las suaves formas de la naturaleza para diseñar la familia de lámparas Bijou. Son lámparas colgantes que resbalan como gotas del techo, pies que parecen florecer como flores y apliques sinuosos y cuadrados, que dominan la escena mediante los juegos de luces que destacan el carácter minimalista chic. La colección Bijou existe en metal pintado de color blanco, negro y cromo y encaja en los ambientes de casas o estructuras privadas y en establecimientos públicos.

Wie viele Designer hat sich auch Prospero Rasulo von den weichen Formen der Natur für die Konstruktion der Lampenkollektion Bijou inspirieren lassen. Hängelampen, die wie Tropfen von der Decke fließen, Bodenlampen, die wie erblühende Blumen erscheinen, eckige und kurvenreiche Wandlampen, die die Szene dank der Lichtspiele beherrschen, die ihren schicken Minimalismus unterstreichen. Die Kollektion Bijou ist in weiß-, schwarzlackiertem und verchromtem Metall erhältlich und für private Wohnungen und öffentliche Lokale geeignet.

A l'instar d'autres designers, Prospero Rasulo s'est laissé inspirer des lignes souples de la nature pour la réalisation des lampes de la série Bijou. Des suspensions qui tombent comme des gouttes du plafond, des lampadaires qui semblent éclore comme des fleurs, des appliques sinueuses et carrées qui se transforment en protagonistes grâce aux jeux de lumière qui soulignent leur minimalisme chic. La collection Bijou est disponible en métal verni blanc, noir et chromé et s'adapte parfaitement aussi bien aux maisons ou aux structures privées qu'aux lieux publics.

Как и многие дизайнеры, Просперо Разуло, для создания семьи ламп Bijou, почерпнул вдохновение в мягких формах природы. Подвесные лампы напоминают капли росы, падающие с потолка, торшеры напоминают распустившиеся цветы, извилистые и квадратные настенные светильники аппликации притягивают к себе внимание, благодаря игре света, которая подчеркивает их утонченный минималистический стиль. Коллекция Bijou выполнена из металла с белым, черным или хромовым лаковым покрытием, она прекрасно подходит как для оформления домашнего интерьера, так и для общественных мест.

# BIJOU

La collezione è costituita da sospensioni, lampade da terra e parete per interno ed esterno. I diffusori e le strutture sono in metallo cromato o verniciato bianco lucido o nero lucido. Le sospensioni sono disponibili in due dimensioni, le lampade da parete a braccetto in due forme: cilindrica e a goccia. Elettrificazione è a tensione di rete per lampade alogene e LED (700mA).

La colección está compuesta por lámparas colgantes, lámparas de pie y apliques de interior y exterior. Los difusores y las estructuras son de metal cromado o pintado de color blanco brillante o negro brillante. Las lámparas colgantes existen en dos tamaños y los apliques con brazos en dos formas, cilíndrica y en gota. Electrificación con tensión de red para bombillas halógenas y LED (700mA).

Die Kollektion besteht aus Hänge-, Wand- oder Stehleuchten für Innenbereich. Diffusoren und Strukturen aus verchromtem Metall oder in glänzendem Weiß oder glänzendem Schwarz lackiert. Die Hängeleuchten sind in zwei Größen und die Wandleuchten mit Arm in zwei Formen (zylindrisch und tropfförmig) erhältlich. Elektrifizierung mit Netzspannung für Halogenlampen oder für LED (700 mA).

The collection is made up of hanging, standard and wall lamps for both indoor and outdoor use. The diffusers and lamp structures are in metal, either chrome-plated or painted in shiny white or black. The hanging lamps are available in two sizes and the wall lamp is available in two shapes: cylindrical or tear drop. The lamp runs on mains power and is suitable for use with halogen and LED bulbs (700mA).

La collection est constituée de suspensions, de lampadaires et d'appliques pour intérieur et extérieur. Les diffuseurs et les structures sont en métal chromé ou verni blanc brillant ou noir brillant. Les suspensions sont disponibles en deux dimensions, les appliques murales à bras sont proposées, soit en forme de goutte, soit en forme cylindrique. Lampes halogènes et LED (700mA) alimentées par la tension du réseau.

Коллекция состоит из подвесных, напольных и настенных светильников для внутренних помещений и открытых пространств. Рассеиватели света и каркасы выполнены из металла с хромовым покрытием, с глянцево-белым или с глянцево-черным лаковым покрытием. Подвесные светильники в наличии в двух размерах, настенные в наличии в двух формах: цилиндрическая и каплевидная. Электрическая часть рассчитана на галогеновую и светодиодную лампу от сетевого напряжения (700mA).





**BIJOU**  
Prospero Rasulo

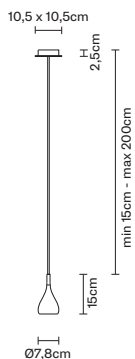

**code**

**electrification**

**technical info**

**accessories**

**D75 A01**  
01 White  
02 Black  
15 Chrome

GU10 220-240V  
1x75W HAGS/UB



**EAC** IP20   
0,007 m<sup>3</sup>  
0,72 kg

NOT INCLUDED:  
- Lampadina / Bulb

GU10 220-240V  
1x5,5W

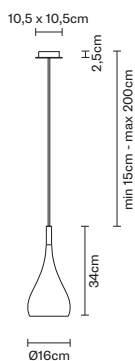

**D75 A05**  
01 White  
02 Black  
15 Chrome

E27 220-240V  
1x205W HSGST



**EAC** IP20   
0,026 m<sup>3</sup>  
1,98 kg

NOT INCLUDED:  
- Lampadina / Bulb

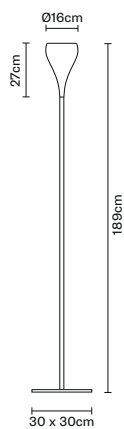

**D75 C01**  
01 White  
02 Black  
15 Chrome

E27 220-240V  
1x205W HSGST



**EAC**  IP20   
0,122 m<sup>3</sup>  
11,38 kg

NOT INCLUDED:  
- Lampadina / Bulb  
- Variatore di luce / Light dimmer



**BIJOU**

Prospero Rasolo

**code**

**electrification**

**technical info**

**accessories**

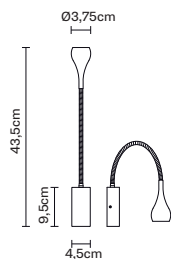

**D75 D01**  
01 White  
02 Black  
15 Chrome

LED 220-240V  
1x3W-30°  
WHITE 3000K  
180lm Cri >80

**EAC** IP20   
0,003 m³  
0,47 kg

**INCLUDED:**  
- LED / LED  
- Interruttore / Switch  
- Alimentatore elettronico / Electronic driver

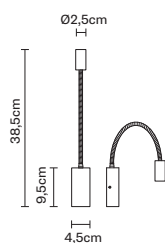

**D75 D03**  
01 White  
02 Black  
15 Chrome

LED 220-240V  
1x3W-30°  
WHITE 3000K  
180lm Cri >80

**EAC** IP20   
0,003 m³  
0,40 kg

**INCLUDED:**  
- LED / LED  
- Interruttore / Switch  
- Alimentatore elettronico / Electronic driver

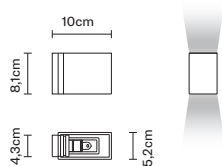

**D75 D07**  
01 White  
02 Black  
15 Chrome

G9 220-240V  
1x48W HSGS

**EAC** IP44  
0,003 m³  
0,48 kg

**NOT INCLUDED:**  
- Lampadina / Bulb

2 tagli di luce stretti / 2 narrow light beams

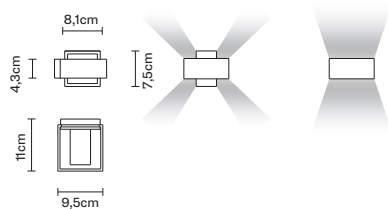

**D75 D09**  
01 White  
02 Black  
15 Chrome

G9 220-240V  
1x48W HSGS

**EAC** IP44   
0,003 m³  
0,55 kg

**NOT INCLUDED:**  
- Lampadina / Bulb

2 tagli di luce larghi o 4 tagli di luce stretti / 2 wide light beams or 4 narrow light beams

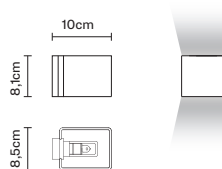

**D75 D15**  
01 White  
02 Black  
15 Chrome

G9 220-240V  
1x48W HSGS

**EAC** IP44  
0,003 m³  
0,55 kg

**NOT INCLUDED:**  
- Lampadina / Bulb

2 tagli di luce larghi / 2 wide light beams

# BOOMY

—

Vittorio Massimo



## CONCEPT

---

Boomy nasce dalla volontà del designer Vittorio Massimo di avere una lampada dal carattere deciso anche quando è spenta. La forma, dalla forte dinamicità plastica, porta con sé echi scultorei che le donano una presenza forte in qualunque ambiente. E' il risultato di una tensione laterale, l'esibizione di un aspetto materico di grande qualità, grazie al materiale impiegato. Le linee di luce con cui illumina per rifrazione la parete che la ospita risultano arretrate e nascoste, facendola apparire quasi sospesa, sottolineandole la forma. Una volta accesa, infatti, diviene una presenza che contrasta in negativo rispetto alla luce creata, esibendo il proprio profilo ricurvo. Boomy è stata insignita del prestigioso premio americano GOOD DESIGN Award 2014.

Boomy was conceived by designer Vittorio Massimo with the idea of creating a lamp with a strong character even when switched off. Its strongly dynamic yet defined shape brings with it sculptural echoes that give it a strong appeal in any environment. This lamp is made with high-quality materials and is powered at both ends. The light source illuminates the walls through refraction and defines the peculiar shape of the wall lamp, giving it a floating appearance. In fact, when the lamp is turned on, the brightness of the light reflected on the wall contrasts with the diffuser, which appears darker, emphasizing its curved shape. Boomy has been invested with the prestigious American GOOD DESIGN Award, 2014.

Boomy es fruto de la voluntad del diseñador Vittorio Massimo para crear una lámpara con un carácter marcado también apagada. La forma, con una gran dinamicidad plástica, presenta rasgos esculturales que le regalan una presencia fuerte en todos los ambientes. Es el resultado de una tensión lateral, la exhibición de un aspecto matérico de gran calidad gracias al material empleado. Las líneas de luz, con las que ilumina mediante refracción la pared donde se encuentra, retroceden y se ocultan por lo que aparece casi colgada y sus formas quedan destacadas. Cuando se enciende se convierte en una presencia que contrasta negativamente la luz creada para exhibir su perfil curvado. Boomy ha sido galardonada con el prestigioso premio estadounidense GOOD DESIGN Award 2014.

Boomy ist das Resultat des Wunsches des Designers Vittorio Massimo nach einer Lampe, deren starker Charakter auch im ausgeschalteten Zustand zum Ausdruck kommt. Ihre Form, die sich durch eine starke, dynamische Plastizität auszeichnet, erzeugt skulptorische Echos, welche jede Art von Raum dominieren. Konzipiert als das Ergebnis einer seitlichen Spannung, enthält Boomy einen materischen Aspekt mit hoher Qualität, auch dank des verwendeten Materials. Die Lichtlinien, mit denen sie mittels Lichtbrechung die Wand erhellt, auf der sie angebracht ist, erscheinen rückständig und versteckt, was die Lampe nahezu frei schwebend erscheinen lässt und ihre Form unterstreicht. Wenn sie eingeschaltet ist, wird sie zu einer Präsenz, die im negativen Kontrast zum gebildeten Licht steht und ihr eigenes gebogenes Profil darstellt. Boomy wurde mit dem amerikanischen Prestigepreis GOOD DESIGN Award 2014 ausgezeichnet.

Boomy a été conçue par le designer Vittorio Massimo, dans le but de créer une lampe de caractère ne passant pas inaperçue, même lorsqu'elle est éteinte. Sa forme, marquée par un dynamisme plastique remarquable, dénote un style sculptural en mesure de personnaliser n'importe quel espace. Ce concept de lampe est le fruit d'une tension latérale appliquée sur un matériau de premier choix. Tout en accentuant sa forme, les traits de lumières, avec lesquels elle illumine par réfraction la paroi sur laquelle elle est posée, semblent plus en retrait et dissimulés, en donnant l'impression qu'elle se trouve en suspension. De fait, lorsqu'elle est allumée, sa présence contraste en négatif par rapport à la lumière créée, en affichant son profil courbe. Boomy s'est vu décerner le prestigieux prix américain GOOD DESIGN Award 2014.

Дизайнер Витторио Массимо решил создать светильник с ярко выраженным характером, даже когда он выключен. Форма светильника Боому, с сильным пластичным динамизмом, несет в себе отклики скульптуры, его присутствие заявляет о себе в любой атмосфере. Светильник является результатом бокового напряжения, представлением аспекта материи высочайшего качества, из которого он выполнен. Линии света на стене кажутся преломленными, боковыми и спрятанными, придают ее поверхности почти подвешенный вид, подчеркивая форму. Когда светильник включен, его внешний вид создает негативный контраст с исходящим от него светом, подчеркивая его криволинейный профиль. Светильник Боому был удостоен престижной американской Премии GOOD DESIGN Award 2014.

# BOOMY

—

Boomy è un'applicque per interno, proposta in due diverse dimensioni con la medesima silhouette, ma proporzioni leggermente differenti. E' realizzata in Cristalplant®, un materiale formato da un'alta percentuale di cariche minerali naturali ed una bassa percentuale di polimeri poliesteri ed acrilici di elevata purezza. La lampada è inoltre pensata a fini compositivi, unendo due o più pezzi si ottengono combinazioni di ogni tipo. L'elettrificazione è a tensione di rete per LED con alimentatore integrato (24Vdc).

Boomy es un aplique de interior, propuesto en dos tamaños con la misma silueta pero con proporciones ligeramente diferentes. Es de Cristalplant®, un material formado por un porcentaje elevado de cargas minerales naturales y por un porcentaje bajo de polímeros poliésteres y acrílicos de elevada pureza. Asimismo la lámpara se ha concebido para crear composiciones y que al unir dos o más piezas se obtienen combinaciones de todos los tipos. La electrificación es con tensión de red para LED mediante alimentador integrado (24Vcc).

Boomy ist eine Wandlampe für Innenbereiche und in zwei Größen verfügbar, mit gleicher Silhouette, aber leicht unterschiedlichen Proportionen. Sie besteht aus Cristalplant®, ein Material mit einem hohen Anteil an natürlichen Mineralien und einem niedrigen Anteil an Polymeren, Polyestern und Akryl mit hoher Reinheit. Die Lampe ist außerdem für zusammensetzende Zwecke entworfen worden: Wenn zwei oder mehrere Teile verbunden werden, können Kombinationen jeder Art erhalten werden. Die Elektrifizierung erfolgt über Netzspannung für LED mit integriertem Netzteil (24 Vdc).

Boomy is a wall lamp for indoor use and is available in two sizes with the same silhouette but slightly different proportions. It is made in Cristalplant®, which has a high percentage of natural mineral fillers and a lower percentage of extremely pure polyester and acrylic polymers. The smart shape of the lamp also makes it suitable for modular compositions, allowing the designer to experiment. The lamp is suitable for use with LED bulbs; it runs on mains power and has a built-in ballast (24Vdc).

Boomy est une applique d'intérieur, proposée en deux dimensions distinctes avec la même silhouette, mais avec des proportions légèrement différentes. Elle est réalisée en Cristalplant®, un matériau composé par un pourcentage élevé d'éléments minéraux naturels et un faible pourcentage de polymères polyesters et acryliques d'une grande pureté. La lampe est également adaptée pour réaliser des compositions personnalisées, en unissant deux ou plusieurs pièces. Les LED sont alimentées par la tension de réseau, avec alimentateur intégré (24Vdc).

Настенный светильник Боомусоздан в двух размерах с одинаковым силуэтом, но немного разных пропорций. Изготавливается из материала Cristalplant® состоит преимущественно из природных материалов с небольшим процентом полиэфирных и акриловых полимеров высокой чистоты. Этот светильник разработан с учетом создания возможных композиций, соединяя два или несколько светильников вместе. Электрическая часть рассчитана на светодиодные лампы от сетевого напряжения, с встроенным блоком питания (24V постоянного тока).



**BOOMY**  
Vittorio Massimo

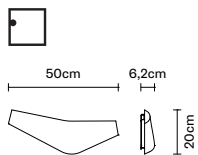

**code**

**electrification**

**technical info**

**accessories**

**F29 D01**  
01 White

LED 220-240V  
1x18W-120°  
WHITE 3000K  
1600lm Cri >80

**EAC** IP20  
0,026 m<sup>3</sup>  
1,76 kg

INCLUDED:  
- LED / LED  
- Alimentatore elettronico dimmerabile /  
Dimmable electronic driver

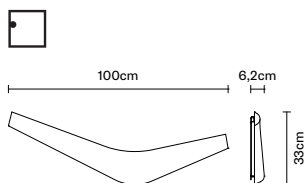

**F29 D03**  
01 White

LED 220-240V  
1x36W-120°  
WHITE 3000K  
3200lm Cri >80

**EAC** IP20  
0,048 m<sup>3</sup>  
3,25 kg

INCLUDED:  
- LED / LED  
- Alimentatore elettronico dimmerabile /  
Dimmable electronic driver



# CLOUDY

—  
Mathieu Lehanneur





## CONCEPT

---

Di solito quando si osservano le nuvole si cercano delle forme organiche, delle similitudini con oggetti o esseri viventi. In questo caso il processo creativo è inverso: si tratta di un oggetto speciale, che durante la sua creazione ha rivelato tutte le sue potenzialità.

“Cloudy è un paradosso! – spiega il giovane designer Mathieu Lehanneur - Questa lampada è stata creata usando degli stampi di acciaio estremamente complessi, che hanno dato ad essa una leggerezza quasi magica, una nuvola di vetro che fluttua nell’aria”. La “nuvola” Cloudy, quando è accesa, rivela tutta la luminosità e rievoca il bagliore di un sole raggianti dopo la pioggia. Cloudy è stata insignita del prestigioso premio IF Design Award 2014.

Normally, when we look at clouds, we seek organic shapes, similar to objects of living beings. In this case, the creative process has been reversed: this is a special object which, during its creation, revealed all its potential. “Cloudy is a paradox! – explains young designer, Mathieu Lehanneur - This lamp was created using extremely complex steel moulds, which have given it an almost magical lightness, a glass cloud floating in the air”. The Cloudy “cloud”, when switched on, thus reveals all its luminosity and evokes sunlight after the rain.

Cloudy has been invested with the prestigious IF Design Award, 2014.

Al observar las nubes se suelen buscar formas orgánicas, similitudes con objetos o seres vivientes. En este caso el proceso creativo se ha invertido: es un objeto especial que, durante su creación, ha dejado todas sus potencialidades al descubierto.

“¡Cloudy es una paradoja! – explica el joven diseñador Mathieu Lehanneur - Esta lámpara se ha creado con moldes de acero muy complejos que le han dado una ligereza casi mágica, una nube de vidrio fluctuante en el aire”. La “nube” Cloudy encendida descubre toda la luminosidad y reevoca el resplandor de un sol radiante después de la lluvia. Cloudy ha sido galardonada con el prestigioso premio IF Design Award 2014.

Normalerweise versucht man beim Betrachten von Wolken, organische Formen auszumachen, die bestimmten Lebewesen oder Gegenständen ähnlich sind. In diesem Fall wird der kreative Vorgang in das Gegenteil verkehrt: Es handelt sich um ein spezielles Objekt, welches im Laufe seiner Kreation sein vollständiges Potential enthüllt hat.

“Cloudy ist ein Paradoxon!”, begeistert sich der junge Designer Mathieu Lehanneur; “Diese Lampe wurde mit dem extrem vielseitigen Stahldruck realisiert, der ihr eine nahezu magische Leichtigkeit verleiht. Sie wirkt wie eine Wolke aus Glas, die in der Luft schwebt”. Die „Wolke“ Cloudy wirkt im eingeschalteten Zustand wie ein Sonnenstrahl nach dem Regen. Cloudy wurde mit dem Prestigepreis IF Design Award 2014 ausgezeichnet.

Habituellement, lorsqu'on observe des nuages, on cherche des formes organiques, des similitudes avec des objets ou des êtres vivants. Dans ce cas spécifique, le processus créatif est inversé : il s'agit d'un objet spécial qui, durant sa création, a révélé toutes ses potentialités.

“Cloudy est un paradoxe ! – nous explique le jeune designer Mathieu Lehanneur - Cette lampe a été conçue en utilisant des moules en acier extrêmement complexes qui lui ont conféré une légèreté quasi magique, un nuage de verre qui flotte dans les airs”. Lorsqu'il est allumé, le “nuage” Cloudy, révèle toute sa luminosité et évoque l'éclat d'un soleil rayonnant après la pluie.

Cloudy s'est vu décerner le prestigieux prix IF Design Award 2014.

Обычно, когда вы смотрите на облака, ищите органические формы, сходство с предметами или живыми существами. В этом случае творческий процесс обратный: речь идет о необычном предмете, который в процессе его создания показал весь свой потенциал. “Cloudy - это парадокс! - рассказывает молодой дизайнер Матьё Леаннэ, - Эта лампа была создана в чрезвычайно сложных стальных пресс-формах, которые наделили ее почти волшебной легкостью: облако из стекла, плывущее в воздухе “. Когда “Облако” Cloudy загорается, расцветает ярким светом, напоминая сияющее солнце после дождя.

Светильник Cloudy был удостоен престижной Премии IF Design Award 2014.

# CLOUDY

---

La collezione si compone di sospensioni e lampade da soffitto in due diverse dimensioni, da utilizzare per ambienti interni. I diffusori sono in vetro soffiato bianco sfumato, trasparente nella parte bassa con strutture metalliche in alluminio pressofuso. I vetri sono prodotti artigianali unici, quindi, tra loro, potrebbero presentare delle variazioni. L'elettrificazione è a tensione di rete per lampade alogene, fluorescenti e LED.

La colección está compuesta por lámparas colgantes y plafones en dos tamaños distintos, para interior. Los difusores son de vidrio soplado blanco difuminado, transparente en la parte inferior con estructuras metálicas de aluminio moldeado a presión. Los elementos de vidrio son productos artesanos únicos y, por consiguiente, podrían presentar variaciones entre sí. La electrificación es con tensión de red para bombillas halógenas, fluorescentes y LED.

Die Kollektion besteht aus Hänge- und Deckenlampen in zwei verschiedenen Abmessungen und ist für Innenbereiche bestimmt. Die Diffusoren sind aus geblasenem, weiß-abgetöntem Glas, im unteren Bereich transparent, mit Metallstrukturen aus druckgegossenem Alu. Die Gläser sind einzigartige handwerkliche Produkte und können somit feine Unterschiede aufweisen. Die Elektrifizierung erfolgt über Netzspannung bei Halogen-, Fluoreszenz- und LED-Lampen.

The collection is made up of hanging and ceiling lamps in two sizes, for indoor use. The diffusers are in white blown glass, transparent at the lower part and hazy towards the top, with structures in die-cast aluminium. Each glass diffuser is hand made and thus unique, which means they may vary slightly from one to another. The lamp runs on mains power and is suitable for use with halogen, fluorescent and LED bulbs.

La collection est composée de suspensions et de plafonniers d'intérieur en deux dimensions différentes. Les diffuseurs sont réalisés en verre soufflé blanc nuancé, transparent dans la partie basse avec des structures métalliques en aluminium moulé sous pression. Les verres sont des produits artisanaux uniques, par conséquent, ils pourraient présenter des variations. Les lampes halogènes, les ampoules fluorescentes et LED sont alimentées par la tension du réseau.

Коллекция состоит из подвесных и потолочных ламп в двух размерах, для использования во внутренних помещениях. Рассеиватели из белого затененного выдувного стекла, прозрачные в нижней части, со структурой из литого алюминия. Выдувные стекла сделаны вручную, поэтому могут немного отличаться друг от друга. Электрическая часть рассчитана на галогеновую, люминесцентную и светодиодную лампу от сетевого напряжения.

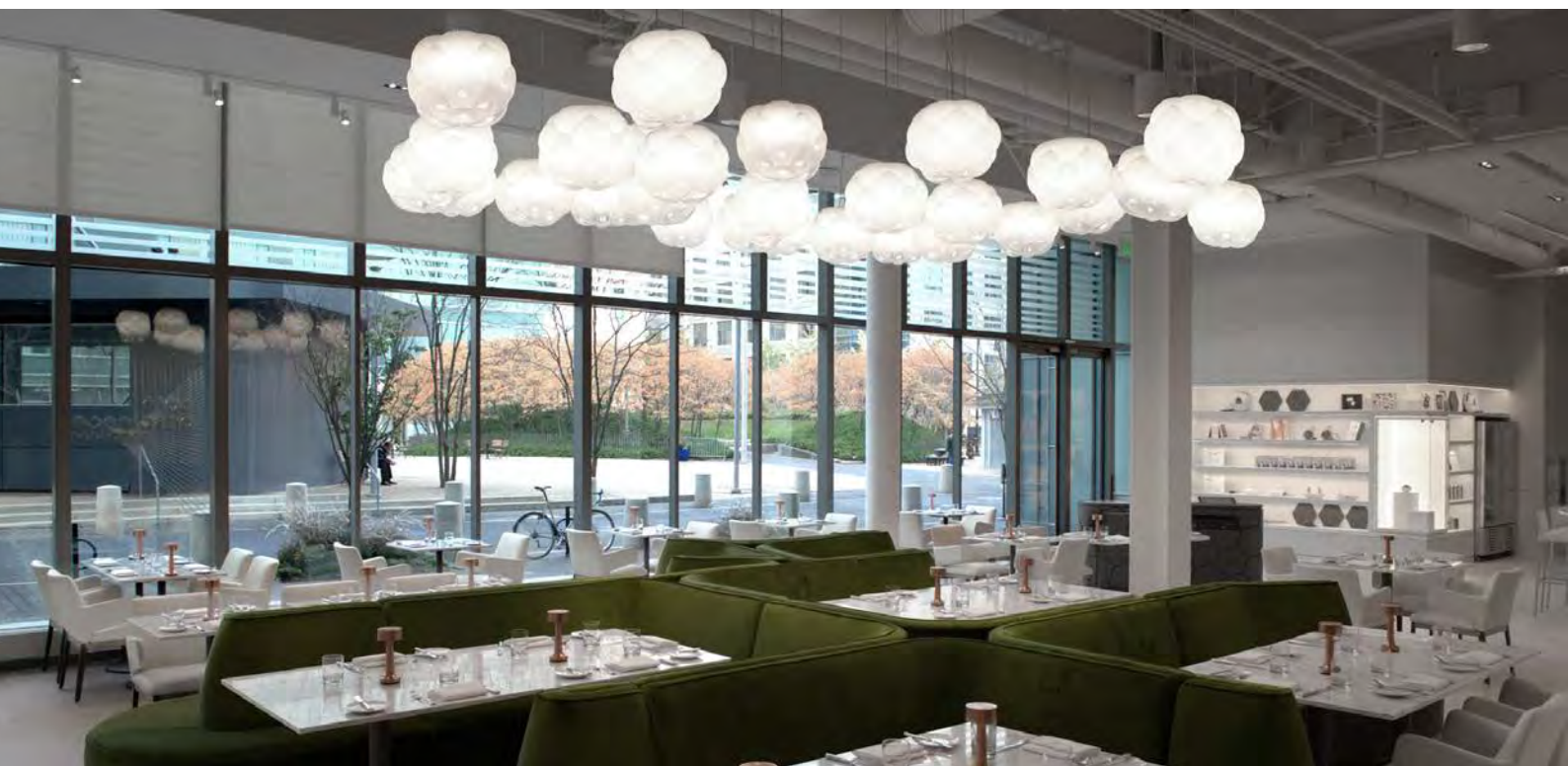

**CLOUDY**  
Mathieu Lehanneur

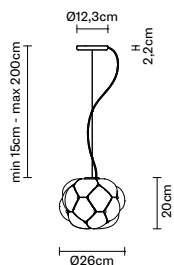

**code**

**electrification**

**technical info**

**accessories**

**F21 A03**  
**71 Translucent**  
*white*

E27 220-240V  
1x77W HSGSA



**EAC** IP20  
0,027 m<sup>3</sup>  
2,48 kg

INCLUDED:  
- Kit per decentramento / *Off-center*  
 *cable fastener*

NOT INCLUDED:  
- Lampadina / *Bulb*

E27 220-240V  
1x15W FBG



**F21 A01**  
**71 Translucent**  
*white*

LED 220-240V  
1x8.7W-120°  
WHITE 3000K  
800lm Cri >80



**EAC** IP20  
0,027 m<sup>3</sup>  
2,41 kg

INCLUDED:  
- LED / *LED*  
- Kit per decentramento / *Off-center*  
 *cable fastener*

Dimmerabile TRIAC / *Dimmable TRIAC*

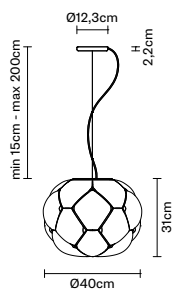

**F21 A05**  
**71 Translucent**  
*white*

E27 220-240V  
1x150W HSGST



**EAC** IP20  
0,106 m<sup>3</sup>  
5,20 kg

INCLUDED:  
- Kit per decentramento / *Off-center*  
 *cable fastener*

NOT INCLUDED:  
- Lampadina / *Bulb*

E27 220-240V  
1x15W FBG



**F21 A02**  
**71 Translucent**  
*white*

LED 220-240V  
1x17W-120°  
WHITE 3000K  
1850lm Cri >80



**EAC** IP20  
0,075 m<sup>3</sup>  
4,76 kg

INCLUDED:  
- LED / *LED*  
- Kit per decentramento / *Off-center*  
 *cable fastener*

Dimmerabile TRIAC / *Dimmable TRIAC*





**CLOUDY**  
Mathieu Lehanneur

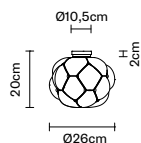

<i>code</i>	<i>electrification</i>	<i>technical info</i>	<i>accessories</i>
<b>F21 E03</b> 71 Translucent white	E27 220-240V 1x77W HSGSA 	<b>EAC</b> IP40 0,027 m <sup>3</sup> 2,03 kg	NOT INCLUDED: - Lampadina / Bulb

E27 220-240V  
1x15W FBG



<b>F21 E01</b> 71 Translucent white	LED 220-240V 1x8.7W-120° WHITE 3000K 800lm Cri >80 	<b>EAC</b> IP40 0,027 m <sup>3</sup> 2,13 kg 	INCLUDED: - LED / LED
-------------------------------------------	--------------------------------------------------------------------------------------------------------------------------------------------------	-----------------------------------------------------------------------------------------------------------------------------------------	--------------------------

Dimmerabile TRIAC / Dimmable TRIAC

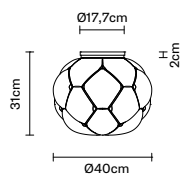

<b>F21 E05</b> 71 Translucent white	E27 220-240V 1x150W HSGST 	<b>EAC</b> IP40 0,075 m <sup>3</sup> 4,15 kg	NOT INCLUDED: - Lampadina / Bulb
-------------------------------------------	-------------------------------------------------------------------------------------------------------------------	----------------------------------------------------	-------------------------------------

E27 220-240V  
1x30W FBT



<b>F21 E02</b> 71 Translucent white	LED 220-240V 1x17W-120° WHITE 3000K 1850lm Cri >80 	<b>EAC</b> IP40 0,075 m <sup>3</sup> 5,13 kg 	INCLUDED: - LED / LED
-------------------------------------------	----------------------------------------------------------------------------------------------------------------------------------------------------	-------------------------------------------------------------------------------------------------------------------------------------------	--------------------------

Dimmerabile TRIAC / Dimmable TRIAC

# CRIO

—

Gio Minelli









# CONCEPT

---

La collezione nasce dallo studio del designer Giovanni Minelli sui poliedri di Archimede e sulle tecnologie di lavorazione del foglio d'alluminio. Un'attenta ricerca d'equilibrio formale e di pensiero, unita ad un chiaro ritorno al rigore geometrico che si propone di delineare un nuovo classicismo.

Il suo corpo è formato dalla compenetrazione di due solidi di diverso materiale, che al loro interno nascondono la fonte luminosa. Particolare attenzione è stata data anche alla ricerca dei materiali di rivestimento al fine di adattare le sospensioni ad ambienti raffinati e unici. Crio caratterizza perfettamente ogni spazio.

The collection is the result of the studies made by designer Giovanni Minelli on the polyhedrons of Archimedes and the techniques for producing aluminium sheeting, and his painstaking research to create a balance between shape and thought, combined with a clear return to geometric rigour which aims to create a new classicism.

Its outer structure is formed by the permeation of two different solids that conceal the light source. Particular attention was placed on the outer materials, to make this hanging lamp suitable for unique, elegant settings, which Crio enhances perfectly.

La colección es fruto del estudio del diseñador Giovanni Minelli sobre los poliedros de Arquímedes y las tecnologías de tratamiento de una lámina de aluminio. Una investigación meticulosa del equilibrio formal y de pensamiento junto a un claro regreso al rigor geométrico, que pretende delinear un nuevo clasicismo. La compenetración de dos sólidos de un material distinto, que esconden la fuente luminosa en el interior, forma el cuerpo. Se ha prestado también una atención especial a la investigación de los materiales de revestimiento para adaptar las lámparas colgantes a ambientes elegantes y únicos. Crio logra caracterizar perfectamente todos los espacios.

Die Kollektion entstand aus der Studie des Designers Giovanni Minelli über Archimedes Polyeder und die Bearbeitungstechnologien von Alufolien. Eine aufmerksame Forschung nach formalem und gedanklichem Ausgleich, vereint mit einer klaren Rückkehr auf die geometrische Strenge, die einen neuen Klassizismus auszeichnen will. Der Körper besteht aus der Verbindung zweier solider Teile aus unterschiedlichem Material, die in sich die Lichtquelle verbergen. Besondere Beachtung wurde auch den Beschichtungsmaterialien gewidmet, um die Hängelampen eleganten und einzigartigen Umgebungen anzupassen. Crio zeichnet jeden Raum perfekt aus.

La collection est le fruit de l'étude du designer Giovanni Minelli sur les polyèdres d'Archimède et sur les technologies de traitement de la feuille d'aluminium. Une recherche méticuleuse sur l'équilibre entre la forme et la pensée, unie à un retour évident à la rigueur géométrique, qui propose d'esquisser un nouveau classicisme. Son corps est formé par la compénétration de deux solides de différent matériaux qui recèlent la source lumineuse en leur sein. Une attention particulière a été dédiée à la recherche des matériaux de revêtement pour que les suspensions puissent s'intégrer dans des contextes raffinés et exclusifs. Crio personnalise parfaitement tous les espaces.

Данная коллекция была создана в студии дизайнера Джованни Минелли на основе полиэдров Архимеда и технологий обработки алюминиевого листа. В результате долгого поиска равновесия форм и мыслей, дизайнеры использовали формы строгой геометрии как символ обращения к новому классицизму. Форма лампы создается из двух твердых тел из разных материалов, пересекающихся друг друга, внутри которых рождается источник света. Большое внимание уделено поиску материалов для покрытия, благодаря чему эти подвесные лампы прекрасно смотрятся в изысканных и неповторимых помещениях. Лампа Crio придает завершенность любому пространству.

# CRIO

---

Crio è costituita da tre sospensioni per interno, di diversa misura, in alluminio verniciato bianco opaco o accoppiato con lamina in legno naturale chiaro ed ebano scuro. A chiudere la calotta c'è il diffusore in PMMA (Polimetilmetacrilato) opalino. L'elettrificazione è a tensione di rete per lampade fluorescenti e LED.

Crio está formada por tres lámparas colgantes de interior (con tamaños distintos), de aluminio pintado de color blanco mate o acoplado con una lámina de madera natural clara y ébano oscuro. El difusor de PMMA (Polimetilmetacrilato) opalino cierra el cuerpo. La electrificación es con tensión de red para bombillas fluorescentes y LED.

Crio besteht aus drei Hängelampen für Innenbereiche in verschiedenen Abmessungen, aus mattweiß lackiertem Alu oder mit hellem und dunklem Naturenholz beschichtet. Die Kappe wird durch den Diffusor aus milchigem PMMA (Polymethylmetacrylat) abgeschlossen. Die Elektrifizierung erfolgt über Netzspannung für Fluoreszenz-Lampen und LED.

The Crio range consists of three different sizes of hanging lamps for indoor use, in aluminium, either painted in a matt white finish or laminated in natural light-coloured wood or dark ebony. The diffuser is in opaline PMMA (polymethylmethacrylate). The lamp runs on mains power and is suitable for use with fluorescent bulbs and LED.

Crio est constituée de trois suspensions d'intérieur de dimensions différentes, en aluminium verni blanc mat ou couplé avec une feuille de bois naturel clair et d'ébène foncé. Le diffuseur en PMMA (polyméthacrylate de méthyle) opalin vient refermer la calotte. Les ampoules fluorescentes et LED sont alimentées par la tension du réseau.

Лампа Crio состоит из трех подвесок разных размеров, из алюминия с матово-белым лаковым покрытием или же с тонким слоем натурального дерева светлого цвета или же цвета темного эбонита. Лампа закрывается рассеивателем из PMMA (полиметилметакрилат) опалового цвета. Электрическая часть рассчитана на люминесцентные и светодиодные лампы от сетевого напряжения.



**CRIO**  
Gio Minelli

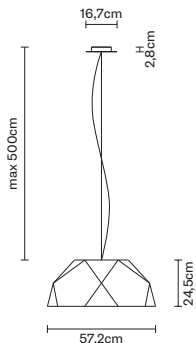

**code**

**electrification**

**technical info**

**accessories**

**D81 A01**

01 White  
48 Dark wood colour  
69 Light wood colour

E27 220-240V  
5x18W FBT



**EAC IP20**

0,176 m<sup>3</sup>  
9,37 kg

NOT INCLUDED:  
- Lampadina / Bulb

**D81 A09**

01 White  
48 Dark wood colour  
69 Light wood colour

LED 220-240V  
3x17,5W-120°  
WHITE 3000K  
6150lm Cri >80



**EAC IP20**

0,176 m<sup>3</sup>  
9,37 kg



INCLUDED:  
- LED / LED  
- Alimentatore elettronico dimmerabile / Dimmable electronic driver

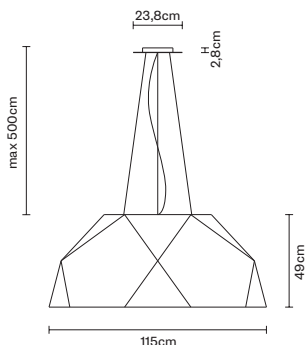

**D81 A03**

01 White  
48 Dark wood colour  
69 Light wood colour

E27 220-240V  
10x22W FBT



**EAC IP20**

1 m<sup>3</sup>  
28,67 kg

NOT INCLUDED:  
- Lampadina / Bulb

**D81 A13**

01 White  
48 Dark wood colour  
69 Light wood colour

LED 220-240V  
5x27,8W-120°  
WHITE 3000K  
16650lm Cri >80



**EAC IP20**

1 m<sup>3</sup>  
28,67 kg



INCLUDED:  
- LED / LED  
- Alimentatore elettronico dimmerabile / Dimmable electronic driver

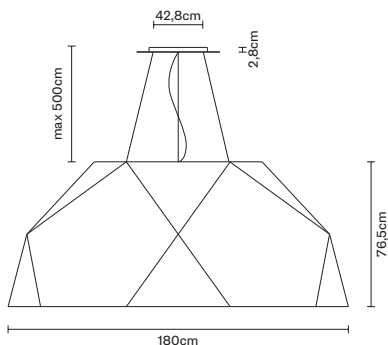

**D81 A17**

01 White  
48 Dark wood colour  
69 Light wood colour

LED 220-240V  
6x27,8W-120°  
WHITE 3000K  
19980lm Cri >80



**EAC IP20**

1 m<sup>3</sup>  
28,67 kg



INCLUDED:  
- LED / LED  
- Alimentatore elettronico dimmerabile / Dimmable electronic driver

# CUBETTO



Pamio Design







## CONCEPT

---

Lo studio Pamio Design “scava in profondo” per dare origine a questa importante collezione. Si va alla ricerca dell’elemento naturale principale, l’acqua, e lo si studia nella suo stato più affascinante, il ghiaccio. Per rappresentarlo al meglio è stato quindi scelto il cristallo, il materiale che più di tutti trasmette il senso di semplicità, eleganza e perfezione. Grande attenzione e maestria viene dedicata alla produzione del materiale, che consiste in tre fasi principali: la preparazione della pasta vitrea, lo stampaggio e successivamente la fase di pulizia del pezzo. Le sostanze della pasta vengono scelte per ottenere il massimo risultato qualitativo.

To create this impressive collection, the Pamio Design studio had to “dig deep down” to find the most important natural element of all, water, and then study it in its most fascinating form: ice. To recreate this substance at its best, the natural choice of material was crystal that conveys a sense of simplicity, elegance and perfection better than any other. A great amount of attention and skill was dedicated to the production of this material and involved three major phases: the preparation of the vitreous paste, the moulding and finally the cleaning phase. The substances used to make the paste were chosen to obtain the highest quality possible.

El estudio Pamio Design “excava en profundidad” para dar origen a esta colección importante. Se busca el elemento natural principal, el agua, para estudiarlo en su estado más fascinante, el hielo. Por consiguiente, para representarlo de la forma mejor se ha elegido el cristal, un material que transmite como ninguno el sentido de sencillez, elegancia y perfección. Se dedica una gran atención y maestría a la producción del material, que consiste en tres fases principales: la preparación de la masa vítrea, el moldeo y, posteriormente, la fase de limpieza de la pieza. Las sustancias de la masa se eligen para obtener el máximo resultado cualitativo.

Das Studio Pamio Design „gräbt tief“, um dieser bedeutenden Kollektion Leben zu geben. Auf der Suche nach dem wichtigsten Naturelement, Wasser, und der Studie seines faszinierendsten Zustands, das Eis. Um es bestens darzustellen, wurde Kristallglas gewählt, ein Material, das besser als alle den Sinn der Einfachheit, Eleganz und Perfektion vermittelt. Eine hohe Beachtung und Kunst wurde der Herstellung des Materials gewidmet, die aus drei Hauptphasen besteht: Die Herstellung der Glaspaste, das Formen und die folgende Reinigung des Teils. Die Substanzen der Paste werden gewählt, um höchste Qualität zu erhalten.

Le studio Pamio Design a “creusé en profondeur” pour créer cette importante collection. Il est parti à la recherche de l’élément naturel principal, en l’étudiant dans son état le plus fascinant: la glace. Le cristal a été choisi pour la représenter au mieux, un matériau sans pareil pour transmettre ce sens de la simplicité, de l’élégance et de la perfection qui lui est propre. Une attention et un savoir-faire particuliers ont été dédiés aux trois phases principales de la production du matériau: la préparation de la pâte de verre, le moulage, puis le nettoyage de la pièce. Les substances de la pâte ont été choisies en vue d’obtenir la meilleure qualité possible.

Дизайн-студия Pamio Design возвращается к истокам, чтобы создать эту важную коллекцию. Дизайнеры работают над основным элементом природы - водой, и изучают этот элемент в самом завораживающем его состоянии – состоянии льда. Чтобы лучше передать суть этого элемента дизайнеры использовали кристалл, как символ простоты, изысканности и перфекционизма. Много внимания и мастерства уделено производству материала, которое происходит в три этапа: подготовка стеклянной пасты, штамповка и чистка изделия. Все составляющие пасты тщательно отбираются для максимального качества изделия.

# CUBETTO

Questa collezione comprende lampade a sospensione, da tavolo, parete e soffitto, per interno. I diffusori sono disponibili in tre versioni: in cristallo sabbiati internamente, con vetri in pasta nera oppure bianca. Per tutte la struttura è in cromo lucido, in aggiunta è ramata e ottonata per il modello da parete e soffitto con diffusore snodato. Elettrificazione a tensione di rete per lampade alogene e led.

Esta colección comprende lámparas colgantes, de sobremesa, apliques y plafones de interior. Los difusores existen en tres versiones: en cristal arenado internamente, con vidrio de masa negra o blanca. Para todas la estructura es de cromo brillante y en los modelos apliques y plafones, con difusor articulado, la estructura es cobriza y latoneada. La electrificación es con tensión de red para bombillas halógenas y led.

Diese Kollektion schließt Hänge-, Tisch-, Wand- und Deckenlampen für Innenbereiche ein. Die Diffusoren sind in drei Ausführungen erhältlich: Aus innen sandgestrahltem Kristallglas, Glas mit schwarzer oder weißer Paste. Bei allen ist die Struktur glanzverchromt, zusätzlich kupfer- oder messingbeschichtet im Falle des Wand- und Deckenmodells mit Gelenkdifusor. Die Elektrifizierung erfolgt über Netzspannung bei Halogen- und LED-Lampen.

This collection includes a hanging, table, wall and ceiling lamp, all for indoor use. The diffusers are available in three versions: in crystal, sand-blasted on the inside, and in a black or white glass paste. For all variants the main structure is available in polished chrome, or with a copper / brass finish for the wall and ceiling lamps with an articulated diffuser. The lamp runs on mains power and is suitable for use with halogen and LED bulbs.

Cette collection comprend des suspensions, des lampes de table, des appliques et des plafonniers, pour intérieur. Les diffuseurs sont disponibles en trois versions: en cristal sablé à l'intérieur, en verre noir ou blanc. La structure de tous les modèles est réalisée en chrome poli et aussi en cuivre et laiton pour le modèle applique/plafonnier avec diffuseur articulé. Lampes halogènes et LED alimentées par la tension du réseau.

Данная коллекция состоит из подвесных, настольных, настенных и потолочных светильников, для внутренних помещений. Рассеиватели представлены в трех вариантах: из кристалла с внутренней пескоструйной обработкой, со стеклом из белой или черной пасты. Металлическая структура из блестящего хрома. Структура настенных и потолочных светильников с сочлененным рассеивателем также может иметь медную и латунированную обработку. Электрическая часть рассчитана на галогеновые и светодиодные лампы от сетевого напряжения.





**CUBETTO**

Pamio Design

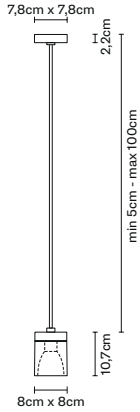

**code**

**electrification**

**technical info**

**accessories**

**D28 A01**  
**00** Transparent  
**01** White  
**02** Black

GU10 220-240V  
 1x50W HAGS/UB



**ERC**  **IP20**

NOT INCLUDED:  
 - Lampadina / Bulb

 0,035 m<sup>3</sup>  
 2,61 kg

GU10 220-240V  
 1x5,5W



Struttura cromata lucida / Polished chrome structure

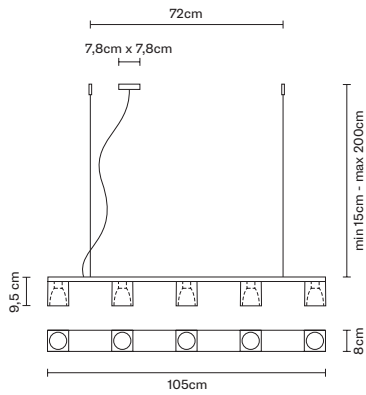

**D28 A05**  
**00** Transparent

G9 220-240V  
 5x48W HSGS



**ERC**  **IP20**

NOT INCLUDED:  
 - Lampadina / Bulb

0,055 m<sup>3</sup>  
 8,66 kg

Struttura cromata lucida / Polished chrome structure

**D28 A06**  
**00** Transparent  
**01** White  
**02** Black

GU10 220-240V  
 5x50W HAGS/UB



**ERC**  **IP20**

NOT INCLUDED:  
 - Lampadina / Bulb

 0,055 m<sup>3</sup>  
 8,65 kg

GU10 220-240V  
 5x5,5W



Struttura cromata lucida / Polished chrome structure

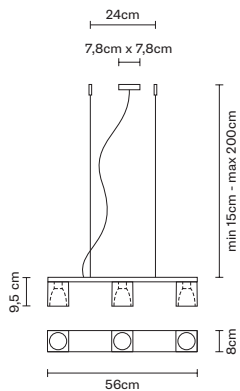

**D28 A13**  
**00** Transparent  
**01** White  
**02** Black

GU10 220-240V  
 3x50W HAGS/UB



**ERC**  **IP20**

NOT INCLUDED:  
 - Lampadina / Bulb

 0,036 m<sup>3</sup>  
 5,01 kg

GU10 220-240V  
 3x5,5W



Struttura cromata lucida / Polished chrome structure

**D28 A14**  
**00** Transparent

G9 220-240V  
 3x48W HSGS



**ERC**  **IP20**

NOT INCLUDED:  
 - Lampadina / Bulb

0,036 m<sup>3</sup>  
 5,14 kg

Struttura cromata lucida / Polished chrome structure



**CUBETTO**

Pamio Design

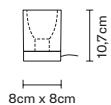

**code**      **electrification**      **technical info**      **accessories**

**D28 B01**      E14 220-240V      **EAC** **IP20**      NOT INCLUDED:  
**00 Transparent**      1x8W FBC      0,005 m<sup>3</sup>      - Lampadina / Bulb  
                                               1,35 kg

E14 220-240V  
1x3,5W



Struttura cromata lucida / Polished chrome structure

**D28 B03**      GU10 220-240V      **EAC** **IP20**      NOT INCLUDED:  
**00 Transparent**      1x75W HAGS/UB      0,005 m<sup>3</sup>      - Lampadina / Bulb  
**01 White**           1,46 kg  
**02 Black**

GU10 220-240V  
1x5,5W



Struttura cromata lucida / Polished chrome structure

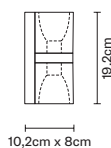

**D28 D01**      GU10 220-240V      **EAC** **IP20**      INCLUDED:  
**00 Transparent**      2x50W HAGS/UB      0,007 m<sup>3</sup>      - Doppia accensione / Double switch  
**01 White**           2,61 kg      NOT INCLUDED:  
**02 Black**      GU10 220-240V      2x5,5W      - Lampadina / Bulb

GU10 220-240V  
2x5,5W



Struttura cromata lucida / Polished chrome structure

**D28 D02**      G9 220-240V      **EAC** **IP20**      INCLUDED:  
**00 Transparent**      2x48W HSGS      0,007 m<sup>3</sup>      - Doppia accensione / Double switch  
                                               2,98 kg      NOT INCLUDED:  
                                                    - Lampadina / Bulb



Struttura cromata lucida / Polished chrome structure

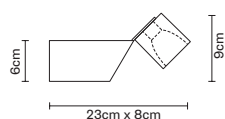

**D28 D03**      R7s (78 mm)      **EAC** **IP20**      INCLUDED:  
**00 Transparent**      220-240V      360° ADJUSTABLE SYSTEM      - Doppia accensione / Double switch  
**01 White**      1x120W HDG      0,012 m<sup>3</sup>      NOT INCLUDED:  
**02 Black**           2,30 kg      - Lampadina / Bulb

GU10 220-240V  
1x50W HAGS/UB



GU10 220-240V  
1x5,5W



Struttura cromata lucida / Polished chrome structure



**CUBETTO**

Pamio Design

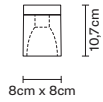

*code*

*electrification*

*technical info*

*accessories*

**D28 E01**  
**00** Transparent  
**01** White  
**02** Black

GU10 220-240V  
 1x50W HAGS/UB



**ERC**  **IP20**

NOT INCLUDED:  
 - Lampadina / Bulb

 0,005 m<sup>3</sup>  
 1,34 kg

GU10 220-240V  
 1x5,5W



Struttura cromata lucida / Polished chrome structure

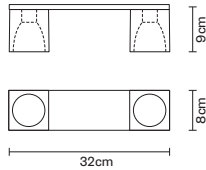

**D28 E02**  
**00** Transparent  
**01** White  
**02** Black

GU10 220-240V  
 2x50W HAGS/UB



**ERC**  **IP20**

NOT INCLUDED:  
 - Lampadina / Bulb

 0,014 m<sup>3</sup>  
 2,44 kg

GU10 220-240V  
 2x5,5W



Struttura cromata lucida / Polished chrome structure

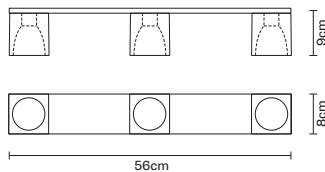

**D28 E03**  
**00** Transparent  
**01** White  
**02** Black

GU10 220-240V  
 3x50W HAGS/UB



**ERC**  **IP20**

NOT INCLUDED:  
 - Lampadina / Bulb

 0,036 m<sup>3</sup>  
 4,00 kg

GU10 220-240V  
 3x5,5W



Struttura cromata lucida / Polished chrome structure

**D28 E04**  
**00** Transparent

G9 220-240V  
 3x48W HSGS



**ERC**  **IP20**

NOT INCLUDED:  
 - Lampadina / Bulb

0,036 m<sup>3</sup>  
 4,46 kg

Struttura cromata lucida / Polished chrome structure



**CUBETTO**

Pamio Design

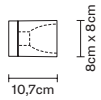

**code**      **electrification**      **technical info**      **accessories**

**D28 G01**  
00 *Transparent*

E14 220-240V  
1x46W HSGSB



**EAC**  **IP20**  
0,005 m<sup>3</sup>  
1,07 kg

NOT INCLUDED:  
- Lampadina / *Bulb*

E14 220-240V  
1x3,5W



E14 220-240V  
1x8W FBC



E14 220-240V  
1x8W FBC



Struttura cromata lucida / *Polished chrome structure*

**D28 G02**  
00 *Transparent*

G9 220-240V  
1x48W HSGS



**EAC**  **IP20**  
0,005 m<sup>3</sup>  
1,35 kg

NOT INCLUDED:  
- Lampadina / *Bulb*

Struttura cromata lucida / *Polished chrome structure*

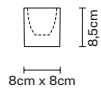

**D28 Z01**  
00 *Transparent*

0,005 m<sup>3</sup>  
1,28 kg

**D28 Z02**  
01 *White*  
02 *Black*

0,005 m<sup>3</sup>  
1,03 kg







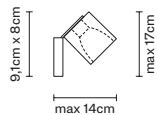





**CUBETTO**  
Pamio Design



<i>code</i>	<i>electrification</i>	<i>technical info</i>	<i>accessories</i>
-------------	------------------------	-----------------------	--------------------

<b>D28 G03</b> 00 Transparent 01 White 02 Black	GU10 220-240V 1x50W HAGS/UB	   0,005 m <sup>3</sup> 1,45 kg	NOT INCLUDED: - Lampadina / Bulb
	 GU10 220-240V 1x5,5W  		





Struttura cromata lucida / Polished chrome structure

<b>D28 G89</b> 00 Transparent	GU10 220-240V 1x50W HAGS/UB	   0,045 m <sup>3</sup> 2,09 kg	NOT INCLUDED: - Lampadina / Bulb
	 GU10 220-240V 1x5,5W  		

Struttura metallica ramata / Copper metal structure

<b>D28 G90</b> 00 Transparent	GU10 220-240V 1x50W HAGS/UB	   0,045 m <sup>3</sup> 2,09 kg	NOT INCLUDED: - Lampadina / Bulb
	 GU10 220-240V 1x5,5W  		

Struttura metallica ottonata / Brass-plated metal structure

<b>D28 G04</b> 00 Transparent	G9 220-240V 1x48W HSGS	   0,005 m <sup>3</sup> 1,38 kg	NOT INCLUDED: - Lampadina / Bulb
	 Struttura cromata lucida / Polished chrome structure		

# CYCLONE

—

Bartek Mejor



## CONCEPT

---

La forma curvilinea della lampada è ispirata all'idea di mostrare il movimento della ceramica liquida lanciata nello spazio.

Il vortice ottenuto, bloccato al momento giusto attorno ad una fonte luminosa, ha dato la forma al diffusore, il quale rimandando a fenomeni meteorologici naturali, conosciuti col nome di cicloni, ha dato il nome alla sospensione. Il lavoro su dei disegni manuali, l'ausilio di moderne tecnologie e programmi hanno aiutato il giovane designer Bartek Mejor a controllare e ad ottenere la forma del diffusore desiderata, anche se il tocco finale, umano, è stato raggiunto grazie ad un modello realizzato in gesso.

The curvy shape of this lamp is inspired by the idea to recreate the movement of liquid ceramic being hurled into the air. The whirling shape obtained, which is 'frozen' at just the right moment around a light source, became the shape for the diffuser, giving the name to this hanging lamp due to its similarity with natural weather forces known as cyclones. Hand sketches, along with advanced techniques and software solutions helped the younger designer Bartek Mejor to obtain the ideal shape for the diffuser, while the final details were perfected with the aid of a hand-made plaster model.

La forma curvilínea de esta lámpara se inspira en la idea de mostrar el movimiento de la cerámica líquida lanzada en el espacio. El vórtice obtenido, bloqueado en el momento justo alrededor de una fuente luminosa, ha desembocado en la forma del difusor, que remitiéndose a fenómenos meteorológicos naturales, conocidos con el nombre de ciclones, regala el nombre a esta lámpara colgante. El trabajo sobre diseños manuales, el uso de tecnologías modernas y programas han ayudado al joven diseñador Bartek Mejor a controlar y obtener la forma elegida del difusor aunque el toque final humano se ha realizado mediante un modelo de yeso.

Die kurvige Form der Lampe entsteht aus der Idee, die Bewegung von flüssigen, in die Luft geworfenen Keramik nachzuempfinden. Der auf diese Weise erzeugte Strudel, genau zum richtigen Zeitpunkt um eine Lichtquelle herum eingefroren, verleiht dem Diffusor seine Form. Dieser verweist auf ein meteorologisches Naturereignis, bekannt unter dem Namen Zyklon, das zum Namenspatron dieser Hängelampe wurde. Die Arbeit mit Zeichnungen von Hand, kombiniert mit dem Einsatz moderner Technologien und Programmen, haben dem jungen Designer geholfen, die beabsichtigte Form des Diffusor umzusetzen. Der letzte Schliff stammte dabei jedoch von Menschenhand, mit Hilfe eines Modells aus Gips.

La forme curviligne de la lampe s'inspire de l'idée de montrer le mouvement de la céramique liquide lancée dans l'espace. Le tourbillon obtenu, bloqué au moment opportun autour d'une source lumineuse, a créé la forme du diffuseur qui évoque les phénomènes météorologiques naturels, connus sous le nom de cyclones, d'où le nom de la suspension. Le travail sur des dessins manuels et l'utilisation de technologies et de programmes modernes ont aidé le jeune designer, Bartek Mejor, à contrôler et à obtenir la forme désirée du diffuseur, même si la touche finale humaine a été obtenue grâce à un modèle réalisé en plâtre.

Криволинейная форма лампы берет вдохновение из желания показать движение жидкой керамики, запущенной в пространство. Созданный вихрь, застывший вокруг источника света, дал форму рассеивателю света, погожего на явление природы, известное как циклон, которое и дало название этой подвесной лампе. Работа над чертежами, помощь современных технологий и программ дало возможность молодому дизайнеру контролировать и в результате получить желаемую форму рассеивателя света, хотя окончательная форма лампы была получена благодаря модели из гипса, сделанной вручную.

# CYCLONE

---

La collezione è costituita da una sospensione disponibile in una sola dimensione, a luce diretta da installare in ambienti interni. Il materiale utilizzato è ceramica bianca nella finitura opaca. L'elettrificazione è a tensione di rete per LED.

La colección está compuesta por una lámpara colgante disponible en un solo tamaño, con luz directa para instalar en ambientes internos. El material empleado es la cerámica blanca para el acabado mate. La electrificación es con tensión de red para LED.

Die Kollektion besteht aus einer Hängelampe in nur einer Abmessung, mit direktem Licht, für Innenräume. Das verwendete Material ist weiße Keramik in matter Ausführung. Die Elektrifizierung erfolgt über Netzspannung bei LED-Lampen.

The collection consists of a single hanging lamp available in one size only, that produces direct light and is suitable for indoor use. It is made in white ceramic with an opaque finish. The lamp runs on mains power and is suitable for use with LED bulbs.

La collection est constituée d'une suspension d'intérieur à lumière directe disponible en une seule dimension. Le matériau employé est de la céramique blanche finition mate. Lampes LED alimentées par la tension du réseau.

Подвесная лампа имеется в наличии в единственном размере, с прямым светом, для оформления внутренних помещений. Используемый материал – белая керамика с матовой поверхностью. Электрическая часть рассчитана на светодиодную лампу от сетевого напряжения.



**CYCLONE**  
Bartek Mejor

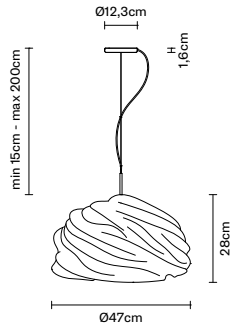

**code**

**electrification**

**technical info**

**accessories**

**F28 A03**  
01 White

E27 220-240V  
1x23W FBC



**EAC** IP20  
0,122 m³  
6,94 kg

INCLUDED:  
- Kit per decentramento / *Off-center cable fastener*

NOT INCLUDED:  
- Lampadina / *Bulb*

E27 220-240V  
1x150W HSGST



**F28 A01**  
01 White

LED 220-240V  
1x17W-120°  
WHITE 3000K  
1850lm CRI >80



**EAC** IP20  
0,122 m³  
6,94 kg

INCLUDED:  
- LED / LED  
- Kit per decentramento / *Off-center cable fastener*



Dimmerabile TRIAC / *Dimmable TRIAC*



# DIAMOND & SWIRL

Bridgewell Consulting LTD.

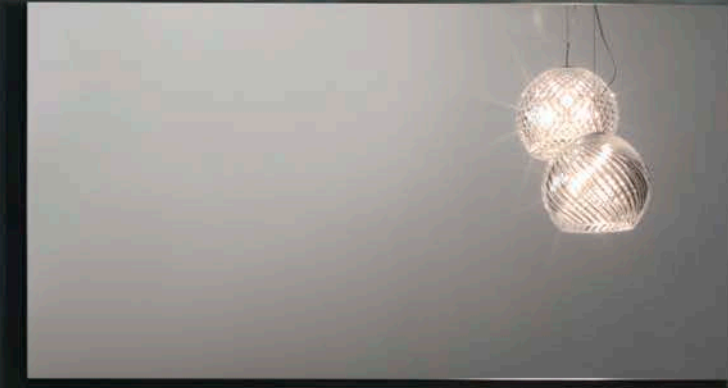

# CONCEPT

---

La collezione DiamondSwirl è stata ispirata dal movimento dell'acqua: le onde che s'infrangono sulla roccia, la schiuma che lascia ornamenti infrangendosi sugli scogli, l'oceano travolgente e impetuoso durante un temporale, i disegni che il mare solca nella sabbia. L'acqua è un diamante, il vento è il vortice che cerca insistentemente di scalfirlo. La materia ha dato forma alla struttura della collezione, il tempo l'ha impreziosita donandole un decoro unico. Bridgewell Consulting LTD ha ottenuto una serie di lampade e lampadari romantici, classici, eleganti e con una storia da raccontare.

The DiamondSwirl collection was inspired by the movement of water: waves breaking onto rocks creating foam sculptures, the overwhelming, impetuous ocean during a storm and the grooves drawn on the sand by the sea. Water is a diamond and the wind is the swirl that tries insistently to scratch its surface, a lengthy process in nature which inspired the unique decorations of this range, allowing Bridgewell Consulting LTD to create a series of lamps and chandeliers which are romantic, classic and elegant and have their very own story to tell.

La colección DiamondSwirl se inspira en el movimiento del agua: las olas que se rompen en la roca, la espuma que deja ornamentos al quebrarse en los escollos, el océano fuerte e impetuoso durante una tormenta y los dibujos surcados por el mar en la arena. El agua es un diamante y el viento es el vórtice que insiste insistentemente rayarlo. La materia da la forma a la estructura de la colección y el tiempo la embellece con una única decoración. Bridgewell Consulting LTD ha creado una serie de lámparas y arañas románticas, clásicas, elegantes y con una historia que contar.

Die Kollektion DiamondSwirl wurde durch die Bewegung des Wassers inspiriert: Die Wellen, die sich am Fels brechen, der Schaum, der Verzierungen an den Klippen hinterlässt, der tobende und ungestüme Ozean während eines Gewitters, die Zeichen, die das Meer im Sand hinterlässt. Das Wasser ist ein Diamant, der Wind ein Strudel, der versucht, ihn ständig zu schleifen. Die Materie hat der Struktur der Kollektion Form verliehen, die Zeit hat sie mit einem einzigartigen Dekor aufgewertet. Bridgewell Consulting LTD hat verschiedene romantische, klassische, elegante Lampen und Leuchten mit einer zu erzählenden Geschichte kreiert.

La collection DiamondSwirl s'est inspirée du mouvement de l'eau: les vagues qui se brisent contre les rochers, l'écume qui laisse des ornements en léchant les roches, l'océan irrésistible et impétueux pendant une tempête, les sillons laissés par la mer dans le sable. L'eau est un diamant, le vent est le tourbillon qui essaye de le rayer avec insistance. La matière a formé la structure de la collection, le temps l'a enrichie en lui conférant une noblesse unique. Bridgewell Consulting LTD a créé une série de lampes et de lampadaires romantiques, classiques, élégants avec une histoire à raconter.

Коллекция светильников DiamondSwirl создана, наблюдая за движением воды: волны, разбивающиеся об скалы, узоры на камнях, оставленные морской пеной, морская буря, подавляющая своей силой и мощностью, борозды на песке при отливе. Вода как алмаз, ветер как вихрь, который хочет его ограничить. Материя придает форму структуре ламп, время обогатило форму оригинальным декором. Bridgewell Consulting LTD создала серию светильников и ламп с романтическим, классическим, изысканным стилем, каждая лампа – это отдельная история.

# DIAMOND & SWIRL

La collezione è costituita da sospensioni e lampade da parete per interno. I diffusori sono in cristallo, molato a mano con due decori grafici, i particolari metallici sono in cromo lucido mentre i paralumi delle lampade a parete sono in canetè-organza. Elettrificazione a tensione di rete per lampade alogene.

La colección está compuesta por lámparas colgantes y apliques de interior. Los difusores son de cristal, tallado a mano con dos decoraciones gráficas, los elementos metálicos son de cromo brillante y las pantallas de los apliques son de canetè-organadí. Electrificación con tensión de red para bombillas halógenas.

Die Kollektion besteht aus Hänge und Wandlampen für innen und außen. Die Diffusoren sind aus handgeschliffenem Kristallglas mit zwei Graphikdekors, die Metallteile sind glanzverchromt, während die Schirme der Wandlampen aus geripptem Organza bestehen. Die Elektrifizierung erfolgt über Netzspannung bei Halogen-Lampen.

The collection is composed of pendant and wall lamps for indoor use. The diffusers are in hand-ground crystal in a choice of two different designs: the metallic fittings are in polished chrome while the lampshades of the wall lamps are in canetè-organza. The lamp runs on mains power and is suitable for use with halogen bulbs.

La collection est constituée de suspensions et d'appliques pour l'intérieur. Les diffuseurs sont en cristal, meulé à la main avec deux décorations graphiques, tandis que les abat-jours des appliques sont réalisés avec des rubans en organza. Lampes halogènes alimentées par la tension du réseau.

Коллекция состоит из подвесных и настенных светильников для внутренних помещений. Рассеиватели выполнены из кристалла с ручной полировкой, с двумя графическими украшениями, металлические отделки из блестящего хрома и настенных светильников из органзы с тесьмой. Электрическая часть рассчитана на галогеновую лампу от сетевого напряжения.





**DIAMOND & SWIRL**  
Bridgewell Consulting LTD.

*code*

*electrification*

*technical info*

*accessories*

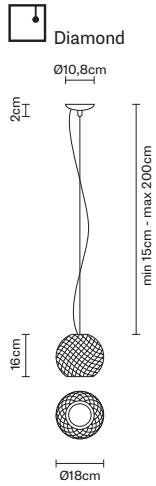

**D82 A01**  
**00 Transparent**

G9 220-240V  
1x60W HSGS  

**EAC** IP20  
0,027 m<sup>3</sup>  
3,31 kg

**INCLUDED:**  
- Kit per decentramento / *Off-center cable fastener*  
**NOT INCLUDED:**  
- Lampadina / *Bulb*



**D82 A03**  
**00 Transparent**

G9 220-240V  
1x60W HSGS  

**EAC** IP20  
0,027 m<sup>3</sup>  
5,40 kg

**INCLUDED:**  
- Kit per decentramento / *Off-center cable fastener*  
**NOT INCLUDED:**  
- Lampadina / *Bulb*

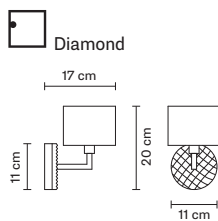

**D82 D01**  
**01 White**  
**02 Black**

G9 220-240V  
1x60W HSGS  

**EAC** IP20  
0,012 m<sup>3</sup>  
1,03 kg

**NOT INCLUDED:**  
- Lampadina / *Bulb*

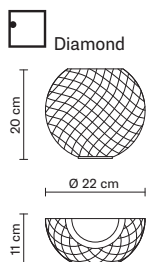

**D82 D99**  
**00 Transparent**

R7s (78 mm)  
220-240V  
1x80W HDG  

**EAC** IP20  
0,026 m<sup>3</sup>  
3,28 kg

**NOT INCLUDED:**  
- Lampadina / *Bulb*



**DIAMOND & SWIRL**  
Bridgewell Consulting LTD.

**code**

**electrification**

**technical info**

**accessories**

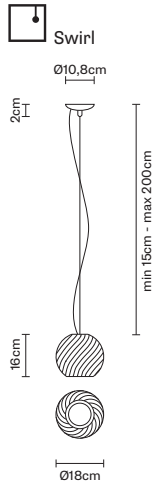

**D82 A05**  
**00 Transparent**

G9 220-240V  
1x60W HSGS



**EAC** IP20  
0,027 m<sup>3</sup>  
3,56 kg

INCLUDED:  
- Kit per decentramento / *Off-center cable fastener*

NOT INCLUDED:  
- Lampadina / *Bulb*

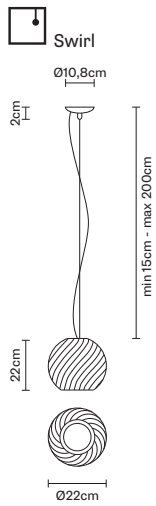

**D82 A07**  
**00 Transparent**

G9 220-240V  
1x60W HSGS



**EAC** IP20  
0,027 m<sup>3</sup>  
5,50 kg

INCLUDED:  
- Kit per decentramento / *Off-center cable fastener*

NOT INCLUDED:  
- Lampadina / *Bulb*

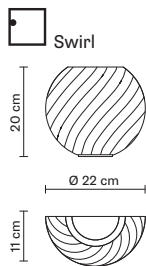

**D82 D98**  
**00 Transparent**

R7s (78 mm)  
220-240V  
1x80W HDG



**EAC** IP20  
0,026 m<sup>3</sup>  
3,34 kg

NOT INCLUDED:  
- Lampadina / *Bulb*

# ENCK

—

Francesco Lucchese



## CONCEPT

---

Enck, di Francesco Lucchese, nasce dall'idea di una luce che filtra attraverso una struttura esile, quasi impercettibile. La forma architettonica è circolare, ispirata alla natura. La sua struttura, formata da due gusci ad incastro, riprende l'idea di una conchiglia. L'immagine poetica che evoca questa lampada viene confermata dalla luce delicata armoniosa, adatta ad ogni tipologia ed esigenza di illuminazione e d'arredo. L'aggancio veloce con la base è studiato per una massima facilità di montaggio e di manutenzione: con una lieve pressione è possibile staccare la lampada dalla staffa fissata a muro.

Enck is the work of Francesco Lucchese and is based on the idea of light filtering through a slim, almost imperceptible structure. The shape is round, inspired by nature. The structure consists of two interlocking outer parts to create the idea of a sea shell. The poetic image evoked by this lamp is furthered by the delicate, harmonious light it produces, making it suitable for all light requirements and furnishing styles. The quick-coupling to the base was designed for utmost ease of assembly and maintenance. Only a slight pressure is required to detach the lamp from the wall-mounted bracket.

Enck, de Francesco Lucchese, nasce de la idea de una luz que se filtra por una estructura delgada casi imperceptible. La forma arquitectural es circular, inspirada en la naturaleza. Su estructura, formada por dos partes encajables, retoma la idea de una concha. La imagen poética evocada por esta lámpara se confirma mediante una luz delicada armoniosa, idónea para todos los tipos y las exigencias de iluminación y decoración. El enganche rápido con la base se ha estudiado para conseguir la máxima facilidad de montaje y mantenimiento: con una ligera presión se desengancha la lámpara del soporte mural.

Enck, von Francesco Lucchese, entstand aus der Vorstellung von Licht, das durch eine zierliche, kaum wahrnehmbare Struktur scheint. Inspiriert von der Natur, ist die architektonische Gestalt dieser Lampe kreisförmig. Die Struktur von Enck, aus zwei ineinander verschränkten Schalen gebildet, nimmt die Idee einer Muschel auf. Das poetische Bild dieser Lampe wird durch das zarte harmonische Licht bestätigt, das sich jeder Typologie und Anforderung zur Beleuchtung und Einrichtung anpasst. Die schnelle Verbindung mit der Basis wurde im Hinblick auf eine Montage und Instandhaltung entwickelt, die so einfach wie möglich ist: Mit der Ausübung eines leichten Drucks kann die Lampe von ihrer Wandhalterung gelöst werden.

Enck, de Francesco Lucchese, est le fruit de l'idée de créer une lumière qui filtre à travers une structure légère, quasiment imperceptible. Sa forme architecturale est circulaire, suscitée par la nature. Sa structure composée de deux coquilles encastrées, reprend l'idée d'un coquillage. L'image poétique dégagée par cette lampe est confirmée par la lumière délicate et harmonieuse, adaptée à toutes les typologies et exigences d'éclairage et de décoration. L'accrochage rapide à la base est conçu pour obtenir une extrême facilité de montage et d'entretien : il est possible de décrocher la lampe de son support fixé au mur en exerçant une simple pression.

Светильник Enck дизайнера Франческо Луккеше рождается от идеи света, который просачивается сквозь тонкую, почти неощутимую структуру. Круглая архитектурная форма вдохновлена природой. Структура Enck состоит из двух сопряженных створок, в виде ракушки. Поэтический образ этого светильника сочетается с исходящим неброским гармоничным светом, который удовлетворяет любые требования по освещению и оформлению интерьера. Простое соединение с базой предназначено для максимального удобства монтажа и обслуживания: легким нажимом можно отсоединить лампу от кронштейна, который крепится к стене.

# ENCK

---

La collezione è formata da lampade da parete e soffitto per interno. La struttura è in pressofusione d'alluminio disponibile in cromo lucido, oro opaco e verniciata bianca opaca. L'elettrificazione è a tensione di rete per lampadine alogene e LED, variabile nel wattaggio in base all'applicazione a soffitto o parete.

La colección está formada por apliques y plafones de interior. La estructura está moldeada a presión de aluminio y existe en cromo brillante, oro mate y pintada blanca mate. La electrificación es con tensión de red para bombillas halógenas y LED, con vatios variables según se trate de un aplique o un plafón.

Die Kollektion besteht aus einer Wand- und Deckenlampe für Innenbereiche. Die Struktur besteht aus Aludruckguss in mattweiß, glanzverchromt und mattgold. Die Elektrifizierung ist eine Netzspannung für Halogen- und LED-Lampen, wobei die Wattstärke im Hinblick auf eine Anbringung an der Decke oder an der Wand angepasst werden kann.

The collection consists of a wall/ceiling lamp for indoor use. The structure is in die-cast aluminium and is available in either polished chrome or a matt white or gold finish. The lamp runs on mains power for halogen and LED bulbs, with a variable wattage depending whether it is mounted on the wall or ceiling.

La collection est composée d'un plafonnier/applique d'intérieur. La structure est en aluminium moulé sous pression, disponible en chromé brillant, or mat et verni blanc mat. Lampes halogènes et LED alimentées par la tension du réseau, wattage variable selon l'application au mur ou au plafond.

Коллекция состоит из настенных и потолочных светильников для внутренних помещений. Структура из литого алюминия с покрытием блестящего хромого, матово-золотого или матово-белого цвета. Электрическая часть рассчитана на галогеновую или светодиодную лампу от сетевого напряжения, различной мощности в зависимости от типа крепления к потолку или к стене.



**ENCK**  
 Francesco Lucchese

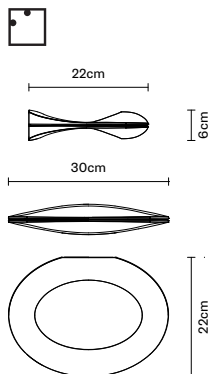

**code**                      **electrification**                      **technical info**                      **accessories**

**F17 G01**  
 01 White  
 12 Gold

R7s (118mm)  
 220-240V  
 1x230W HDG

 **EAC IP20**  
 0,01 m<sup>3</sup>  
 1,66 kg

NOT INCLUDED:  
 - Lampadina / Bulb



R7s (118mm)  
 220-240V  
 1x160W HDG



**F17 G03**  
 01 White  
 12 Gold

LED 220-240V  
 4x4.5W-120°  
 WHITE 2700K  
 1600lm CRI >80

 **EAC IP40**  
 0,01 m<sup>3</sup>  
 1,72 kg

INCLUDED:  
 - LED / LED



Dimmerabile TRIAC / Dimmable TRIAC



# EYES

—

Matali Crasset









## CONCEPT

---

**Cosa c'è di più semplice rispetto a una bolla di vetro di luce? Come si può dare intensità ad un profilo così essenziale? Matali Crasset, designer di Eyes, si è ispirata a queste domande per definire la forma dei diffusori luminosi, e con tre punti incavati nella sfera è riuscita ad ottenere le due intensità di luce cercate. Eyes ricorda un altoparlante che diffonde un'energia nitida e decisa attraverso il vetro, che diventa lo strumento fondamentale per espandere la luce in tutti gli ambienti. In questa particolare collezione di lampade convivono la semplicità della sfera e l'essenza tecnica del disegno ricreato come coni a coste nei tre solchi. Un oggetto che sa portare personalità in ogni ambiente.**

What could be more simple than a glass ball? How can you give intensity to such an essential profile? Matali Crasset, the designer of Eyes took inspiration from these questions in order to create a this shape of lighting diffusers, and with three spots hollowed out inside the sphere was able to obtain the two different light intensities she was looking for. The Eyes lamp, similar to an amplifier, spreads a clear, bright energy through the fundamental glass element, diffusing light in every environment. In this particular lamp collection, the simplicity of the sphere meets the technical essence of the design, and recreates ribbed conical cones inside the grooves, to become an object that conveys character to any environment.

¿Hay algo más sencillo que una burbuja de vidrio de luz? ¿Cómo se puede dar intensidad a un perfil tan esencial? Matali Crasset, diseñador de Eyes, se ha inspirado en estas preguntas para definir la forma de los difusores luminosos y con tres puntos efectuados en la bola ha conseguido obtener las dos intensidades buscadas de luz. Eyes nos recuerda un altavoz que difunde una energía nítida y marcada mediante el vidrio, que se convierte en una herramienta fundamental para transmitir la luz en todos los ambientes. En esta colección especial de lámparas conviven la sencillez de la bola y la esencia técnica del dibujo recreado como conos con nervios en los tres surcos. Un objeto que sabe regalar personalidad a todos los ambientes.

Gibt es etwas Einfacheres als eine leuchtende Glaskugel? Wie kann man einem so essentiellen Profil Intensität verleihen? Matali Crasset, Designerin von Eyes, inspirierte sich an diesen Worten, um die Form der Leuchtdiffusoren zu definieren. Mit drei in der Kugel eingebrachten Punkten war sie in der Lage, die beiden gesuchten Lichtintensitäten zu finden. Eyes erinnert an einen Lautsprecher, der eine klare und entschiedene Energie durch das Glas verteilt, das zu einem grundsätzlichen Instrument wird, um das Licht in allen Umgebungen zu verbreiten. In dieser besonderen Lampenkollektion leben die Einfachheit der Kugel und die technische Essenz des Designs zusammen, das in den drei Einschnitten als gerippte Kegel kreiert wurde. Ein Gegenstand, der jeder Umgebung Persönlichkeit verleiht.

Qu'y-a-t-il de plus simple qu'une bulle de lumière en verre? Comment peut-on donner de l'intensité à un profil aussi essentiel? Matali Crasset, designer de Eyes, s'est inspirée de ces questions pour définir la forme des diffuseurs de lumière, en obtenant les deux intensités de lumières qu'elle cherchait, grâce à trois points échancrés sur la sphère. Eyes rappelle un haut-parleur diffusant une énergie nette et claire à travers le verre, qui devient l'instrument fondamental pour répandre la lumière dans n'importe quel environnement. La simplicité de la sphère et l'essence technique du dessin recréé comme des cônes côtelés dans les trois sillons se marient parfaitement dans cette collection de lampes très particulière. Il s'agit là d'un objet sachant donner de la personnalité à tout type d'environnement.

Что может быть проще, чем стеклянный шар, наполненный светом? Но как придать насыщенности такой простой форме? Именно этот вопрос задавал себе дизайнер Матали Крассет, создавая линейку светильников Eyes: за счет трех углублений в шаре ему удалось получить два типа интенсивности освещения. Светильники Eyes своей формой напоминают динамик, рассеивающий четкий и решительный поток света, становясь, тем самым, основным источником освещения в любом помещении. В этой оригинальной коллекции светильники хорошо уживаются с простотой плафона и сущностью технического проекта, воссозданного в виде конуса с тремя канавками по бокам. Светильники коллекции Eyes смогут привнести некую индивидуальность в каждое пространство.

# EYES

—

La collezione Eyes è costituita da una sospensione, una lampada da soffitto e una lampada da tavolo per ambienti interni, disponibili in due varianti di colori: vetro soffiato trasparente e vetro soffiato bianco latte acidato. La sospensione è disponibile con struttura in finitura verniciata bianca opaca e ramata lucido mentre la lampada da soffitto e la lampada da tavolo sono disponibili con struttura in finitura verniciata bianca opaca. L'elettrificazione è a tensione di rete per lampade fluorescenti.

La colección Eyes está constituida por una lámpara colgante, un plafón y una lámpara de sobremesa para ambientes internos, disponibles en dos colores diferentes: vidrio soplado transparente y vidrio soplado blanco lechoso esmerilado. La lámpara colgante presenta una estructura con acabado pintado de color blanco mate y cobrizo brillante mientras que el plafón y la lámpara de sobremesa presentan una estructura con acabado pintado de color blanco mate. La electrificación es con tensión de red para bombillas fluorescentes.

Die Kollektion Eyes besteht aus einer Hängelampe, einer Deckenlampe und einer Tischlampe für Innenbereiche, in zwei Farbvarianten erhältlich: Transparent geblasenes Glas und geätztes milchweißes geblasenes Glas. Die Hängelampe ist mit einer mattweiß lackierten und kupferpolierten Struktur erhältlich, während die Decken- und Tischlampen mit einer mattweiß lackierten Struktur angeboten werden. Die Elektrifizierung erfolgt über Netzspannung für Fluoreszenz-Lampen.

The Eyes collection is made up of a pendant lamp, a ceiling lamp and a table lamp for indoor rooms. Available in two colour variations; transparent and white frosted glass. The pendant lamp is available with an opaque white finish and shiny copper while the ceiling and table lamps are available with an opaque white finish. The energy voltage is suitable for fluorescent bulbs.

La collection Eyes se compose d'une suspension, d'un plafonnier et d'une lampe de table pour l'intérieur. Ces luminaires sont proposés dans deux couleurs: verre soufflé transparent et verre soufflé blanc lait dépoli. La lampe suspension est proposée avec une structure peinte en blanc opaque ou cuivre brillant. Quant au plafonnier et à la lampe de table, ils sont disponibles avec une structure peinte en blanc opaque. L'électrification est à tension de réseau pour des ampoules fluorescentes.

Коллекция Eyes для внутреннего освещения представлена подвесным светильником, люстрой и настольной лампой, которые доступны в двух цветовых решениях: прозрачном и матовом молочном-белом. Структура подвесного светильника может иметь матовую белую или глянцевую медную отделку, в то время, как структура люстры и настольной лампы отделана матовой белой краской. Цоколь предназначен для люминесцентных ламп.



**EYES**

Matali Crasset

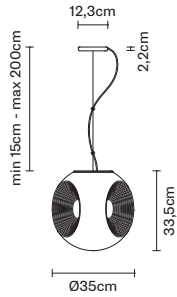

**code**

**electrification**

**technical info**

**accessories**

**F34 A01**  
00 Transparent  
01 White

E27 220-240V  
1x23W FBC



**EAC** IP20  
0,106 m<sup>3</sup>  
5,10 kg

NOT INCLUDED:  
- Lampadina / Bulb

E27 220-240V  
1x7.5W



Struttura verniciata bianca / White painted structure

**F34 A03**  
00 Transparent  
01 White

E27 220-240V  
1x23W FBC



**EAC** IP20  
0,106 m<sup>3</sup>  
5,10 kg

NOT INCLUDED:  
- Lampadina / Bulb

E27 220-240V  
1x7.5W



Struttura ramata lucida / Copper-plated structure

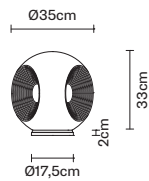

**F34 B01**  
00 Transparent  
01 White

E27 220-240V  
1x23W FBC



**EAC** IP40  
0,106 m<sup>3</sup>  
5,13 kg

NOT INCLUDED:  
- Lampadina / Bulb

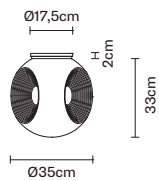

**F34 G01**  
00 Transparent  
01 White

E27 220-240V  
1x23W FBC



**EAC** IP40  
0,106 m<sup>3</sup>  
5,26 kg

NOT INCLUDED:  
- Lampadina / Bulb

# FARETTI

Pamio Design / Luca Scacchetti



# CONCEPT

---

Pamio Design, dopo un accurato studio sulle forme, è riuscito ad ottenere un'ampia collezione d'incassi che oltre ad essere funzionali possiedono una bellezza intrinseca. Il designer infatti ha voluto dare un tocco di ricercatezza e rendere meno tecnici e freddi i soliti spot ad incassi. Ne è risultato una gamma di "piccole gemme di luce" che impreziosiscono i soffitti delle nostre case e rendono le atmosfere degli spazi eleganti e unici. Le forme e le sfaccettature sono state ideate per valorizzare al meglio l'effetto finale grazie anche all'uso del cristallo come materiale per diffondere la luce.

After carefully studying several shapes, Pamio Design succeeded in obtaining a wide range of recessed lighting fixtures that were both functional and very good-looking. The designer wanted, in fact, to add a touch of elegance to the usual recessed spotlights, making them less technical and cold. The result is a range of "small gems of light", that enhance the ceiling in any home, creating elegant, unique atmospheres. The shapes and facets were conceived to produce the best lighting possible, also thanks to the use of crystal for the diffusers.

Tras un estudio meticuloso de las formas, Pamio Design ha conseguido obtener una amplia colección de focos funcionales pero también con una belleza intrínseca. De hecho, el diseñador ha querido imprimir un toque de elegancia y conseguir focos clásicos pero menos técnicos y fríos. El resultado es una gama de "piedras pequeñas de luz" que embellecen los techos de nuestras casas y crean atmósferas elegantes y únicas en los espacios. Las formas y las facetas se han pensado para valorizar de la forma mejor el efecto final mediante también el uso del cristal como material para difundir la luz.

Pamio Design hat es nach einer sorgfältigen Formenstudie geschafft, eine große Einbaukollektion zu erhalten, die nicht nur funktionstüchtig, sondern auch charakteristisch schön ist. Der Designer hat einen ausgesuchten Touch verleihen und die üblichen Einbauspots weniger technisch und kalt gestalten wollen. Daraus ergab sich eine Kollektion mit „kleinen Lichtedelsteinen“, die die Decken unserer Häuser wertvoll und die Atmosphäre der Räume elegant und einzigartig gestalten. Die Formen und Facetten wurden entwickelt, um den Endeffekt auch dank der Anwendung von Kristallglas als Lichtverteilungsmaterial aufzuwerten.

Suite à une étude approfondie sur les formes, Pamio Design est parvenu à créer une vaste collection de spots encastrables fonctionnels, dotés d'une beauté intrinsèque. En effet, le designer a voulu donner une touche de style afin de s'éloigner de l'aspect froid et technique des spots encastrables traditionnels. Le résultat est la création d'une gamme de "petites gemmes de lumière" qui embellissent les plafonds de nos maisons et rendent les atmosphères des pièces élégantes et uniques. Les formes et les facettes ont été conçues pour valoriser au mieux l'effet final notamment grâce à l'utilisation du cristal comme matériau pour diffuser la lumière.

Дизайн-студия Pamio Design, после длительных экспериментов над формами, создала коллекцию не только максимально функциональных, но и очень красивых встраиваемых светильников. Дизайнер хотел придать этим лампам более изящный вид, убрать ощущение технического холода, которое так присуще встраиваемым светильникам. В результате коллекция похожа на «маленькие жемчужины света», которые украшают потолки наших домов и придают неповторимость и изысканность домашнему интерьеру. Формы и грани светильников были задуманы для создания максимального эффекта, благодаря использованию кристалла для рассеивания света.

# FARETTI

Apparecchi d'illuminazione ad incasso per interno. I diffusori sono di diverso materiale: in vetro pressato trasparente o satinato, in cristallo pressato trasparente o satinato o parzialmente schermato con frontalino in acciaio inox, in vetro soffiato. L'elettificazione è a bassa tensione e a bassissima tensione (12V) per lampade alogene e in corrente costante per LED (700mA).

Focos de empotrar de interior. Los difusores son de materiales distintos: en vidrio prensado transparente o satinado, en cristal prensado transparente o satinado o parcialmente apantallado con frente de acero inoxidable, de vidrio soplado. La electrificación es con baja tensión de red y con tensión muy baja (12V) para bombillas halógenas y en corriente continua para LED (700mA).

Einbauleuchten für Innenbereiche. Diffusoren: Aus gepresstem transparentem oder satiniertem Glas, aus gepresstem, transparentem oder satiniertem Kristallglas oder mit Frontblende aus Edelstahl, aus mundgeblasenem Glas. Elektrifizierung mit Niederspannung und 12V-Spannung für Halogenlampen oder mit Gleichspannung für LED (700 mA).

Recessed lighting fixtures for indoor use. The diffusers are available in different materials: pressed transparent or satin-finish glass, pressed lead crystal with a transparent or satin-finish, or partially screened in blown glass with a polished stainless steel frame. The lamps run on a low / very low voltage (12V) for halogen bulbs and mains power for LED bulbs (700mA).

Spots encastrables d'intérieur. Les diffuseurs sont réalisés avec divers matériaux : en verre transparent pressé ou mat, en cristal pressé transparent ou mat ou partiellement voilé avec un élément en acier inox, en verre soufflé. Lampes halogènes alimentées à très basse tension (12V) et LED à courant constant (700mA).

Коллекция встраиваемых светильников для внутренних помещений. Рассеиватели из различных материалов: прозрачного или сатинированного прессованного стекла, из кристалла, прозрачного или сатинированного или частично закрытого панелью из нержавеющей стали, из выдутого стекла. Электрическая часть рассчитана на низкое и очень низкое напряжение (12V) для галогеновых ламп, и для светодиодных ламп при постоянном напряжении.





**FARETTI**

Pamio Design / Luca Scacchetti

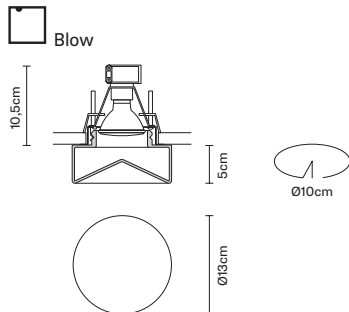

**code**      **electrification**      **technical info**      **accessories**

**D27 F17**  
00 Transparent

GU10 220-240V  
1x75W HAGS/UB

150° C

0,01 m<sup>3</sup>  
0,67 kg

GU10 220-240V  
1x5,5W

LED

**EAC** □ IP20 / IP44

NOT INCLUDED:  
- Lampadina / Bulb

**D27 F18**  
00 Transparent

GU5,3 12V  
1x50W HRGS

0,01 m<sup>3</sup>  
0,67 kg

GU5,3 12V  
1x4W

LED

**EAC** ◇ IP20 / IP44

NOT INCLUDED:  
- Lampadina / Bulb  
- Trasformatore / Transformer

**D27 F47**  
00 Transparent

LED 700mA  
1x14W-40°  
WHITE 3000K  
1200lm CRI >80

0,01 m<sup>3</sup>  
0,56 kg

LED

**EAC** ◇ IP20 / IP44

INCLUDED:  
- LED / LED

NOT INCLUDED:  
- Alimentatore / Driver

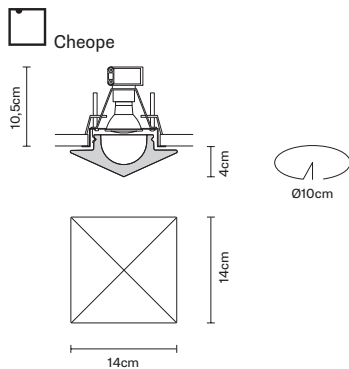

**D27 F07**  
00 Transparent  
01 White

GU10 220-240V  
1x50W HAGS/UB

150° C

0,01 m<sup>3</sup>  
1,18 kg

GU10 220-240V  
1x5,5W

LED

**EAC** □ IP20 / IP44

NOT INCLUDED:  
- Lampadina / Bulb

**D27 F08**  
00 Transparent  
01 White

GU5,3 12V  
1x50W HRGS

0,01 m<sup>3</sup>  
1,23 kg

GU5,3 12V  
1x4W

LED

**EAC** ◇ IP20 / IP44

NOT INCLUDED:  
- Lampadina / Bulb  
- Trasformatore / Transformer

**D27 F37**  
00 Transparent  
01 White

LED 700mA  
1x14W-40°  
WHITE 3000K  
1200lm CRI >80

0,01 m<sup>3</sup>  
1,12 kg

LED

**EAC** ◇ IP20 / IP44

INCLUDED:  
- LED / LED

NOT INCLUDED:  
- Alimentatore / Driver



**FARETTI**

Pamio Design / Luca Scacchetti

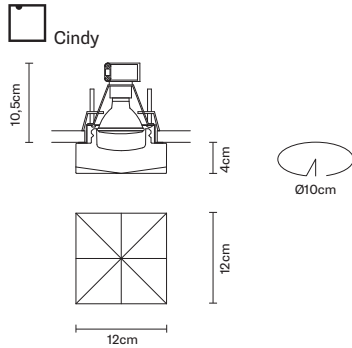

code	electrification	technical info	accessories
<b>D27 F28</b> 00 Transparent 01 White	GU10 220-240V 1x50W HAGS/UB	<b>ERC</b> IP20 IP44 150° C	NOT INCLUDED: - Lampadina / Bulb
	GU10 220-240V 1x5,5W	<b>LED</b> 0,01 m <sup>3</sup> 1,27 kg	
<b>D27 F29</b> 00 Transparent 01 White	GU5,3 12V 1x50W HRGS	<b>ERC</b> IP20 IP44 0,01 m <sup>3</sup> 1,25 kg	NOT INCLUDED: - Lampadina / Bulb - Trasformatore / Transformer
	GU5,3 12V 1x4W	<b>LED</b> 0,01 m <sup>3</sup> 1,25 kg	
<b>D27 F49</b> 00 Transparent 01 White	LED 700mA 1x14W-40° WHITE 3000K 1200lm CRI >80	<b>ERC</b> IP20 IP44 0,01 m <sup>3</sup> 1,12 kg	INCLUDED: - LED / LED NOT INCLUDED: - Alimentatore / Driver

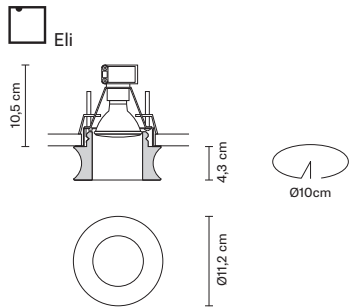

<b>D27 F51</b> 00 Transparent 01 White	GU10 220-240V 1x75W HAGS/UB	<b>ERC</b> IP20 150° C	NOT INCLUDED: - Lampadina / Bulb
	GU10 220-240V 1x5,5W	<b>LED</b> 0,01 m <sup>3</sup> 1,02 kg	
<b>D27 F52</b> 00 Transparent 01 White	GU5,3 12V 1x50W HRGS	<b>ERC</b> IP20 0,01 m <sup>3</sup> 0,98 kg	NOT INCLUDED: - Lampadina / Bulb - Trasformatore / Transformer
	GU5,3 12V 1x4W	<b>LED</b> 0,01 m <sup>3</sup> 0,98 kg	
<b>D27 F54</b> 00 Transparent 01 White	LED 700mA 1x14W-40° WHITE 3000K 1200lm CRI >80	<b>ERC</b> IP20 0,01 m <sup>3</sup> 0,98 kg	INCLUDED: - LED / LED NOT INCLUDED: - Alimentatore / Driver



**FARETTI**

Pamio Design / Luca Scacchetti

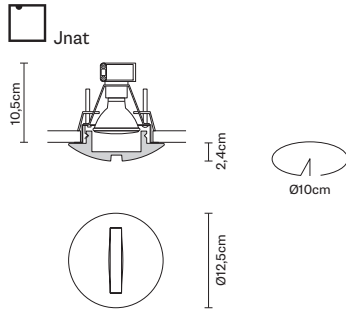

**code**      **electrification**      **technical info**      **accessories**

**D27 F03**  
**00 Transparent**  
**01 White**

GU10 220-240V  
 1x50W HAGS/UB



IP20  
 IP44

NOT INCLUDED:  
 - Lampadina / Bulb

150° C

0,01 m<sup>3</sup>  
 0,88 kg

GU10 220-240V  
 1x5,5W



**D27 F04**  
**00 Transparent**  
**01 White**

GU5,3 12V  
 1x50W HRGS



IP20  
 IP44

NOT INCLUDED:  
 - Lampadina / Bulb  
 - Trasformatore / Transformer

0,01 m<sup>3</sup>  
 0,82 kg

GU5,3 12V  
 1x4W



**D27 F33**  
**00 Transparent**  
**01 White**

LED 700mA  
 1x14W-40°  
 WHITE 3000K  
 1200lm Cri >80



IP20  
 IP44

INCLUDED:  
 - LED / LED  
  
 NOT INCLUDED:  
 - Alimentatore / Driver

0,01 m<sup>3</sup>  
 0,97 kg

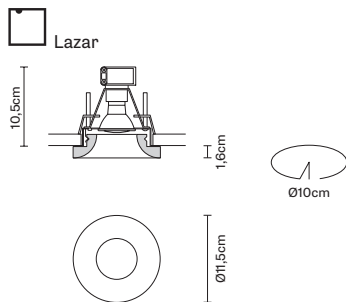

**D27 F05 C1**  
**01 White**

GU10 220-240V  
 1x50W HAGS/UB



IP20

NOT INCLUDED:  
 - Lampadina / Bulb

150° C

0,048 m<sup>3</sup>  
 6,10 kg

GU10 220-240V  
 1x5,5W



**D27 F06 C1**  
**01 White**

GU5,3 12V  
 1x50W HRGS



IP20

NOT INCLUDED:  
 - Lampadina / Bulb  
 - Trasformatore / Transformer

0,048 m<sup>3</sup>  
 6,70 kg

GU5,3 12V  
 1x4W



**D27 F35**  
**01 White**

LED 700mA  
 1x14W-40°  
 WHITE 3000K  
 1200lm Cri >80



IP20

INCLUDED:  
 - LED / LED  
  
 NOT INCLUDED:  
 - Alimentatore / Driver

0,01 m<sup>3</sup>  
 0,62 kg





**FARETTI**

Pamio Design / Luca Scacchetti

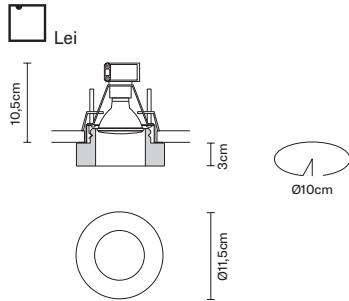

**code**      **electrification**      **technical info**      **accessories**

**D27 F13**  
00 *Transparent*

GU10 220-240V  
1x75W HAGS/UB



**ERL** □ IP20

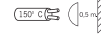

NOT INCLUDED:  
- Lampadina / Bulb

0,01 m<sup>3</sup>  
0,96 kg

GU10 220-240V  
1x5,5W



LED

**D27 F14**  
00 *Transparent*

GU5,3 12V  
1x50W HRGS



**ERL** ◇ IP20



NOT INCLUDED:  
- Lampadina / Bulb  
- Trasformatore / Transformer

0,01 m<sup>3</sup>  
0,99 kg

GU5,3 12V  
1x4W



LED

**D27 F43**  
00 *Transparent*

LED 700mA  
1x14W-40°  
WHITE 3000K  
1200lm CRI >80



**ERL** ◇ IP20

0,01 m<sup>3</sup>  
1,14 kg

INCLUDED:  
- LED / LED  
  
NOT INCLUDED:  
- Alimentatore / Driver

LED

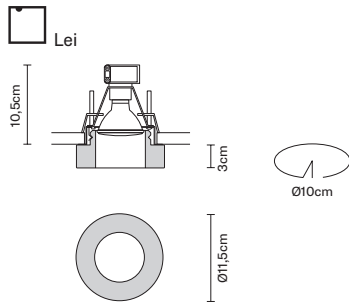

**D27 F15**  
35 *Polished stainless steel*

GU10 220-240V  
1x75W HAGS/UB



**ERL** □ IP20

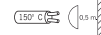

NOT INCLUDED:  
- Lampadina / Bulb

0,01 m<sup>3</sup>  
1,09 kg

GU10 220-240V  
1x5,5W



LED

**D27 F16**  
35 *Polished stainless steel*

GU5,3 12V  
1x50W HRGS



**ERL** ◇ IP20



NOT INCLUDED:  
- Lampadina / Bulb  
- Trasformatore / Transformer

0,01 m<sup>3</sup>  
0,92 kg

GU5,3 12V  
1x4W



LED

**D27 F44**  
35 *Polished stainless steel*

LED 700mA  
1x14W-40°  
WHITE 3000K  
1200lm CRI >80



**ERL** ◇ IP20

0,01 m<sup>3</sup>  
1,14 kg

INCLUDED:  
- LED / LED  
  
NOT INCLUDED:  
- Alimentatore / Driver

LED





**FARETTI**

Pamio Design / Luca Scacchetti

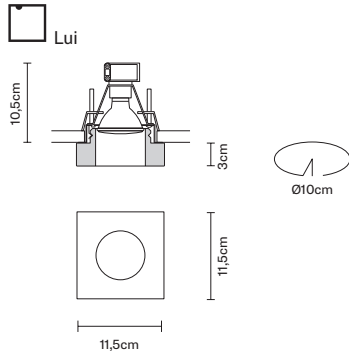

**code**      **electrification**      **technical info**      **accessories**

**D27 F09**  
00 *Transparent*

GU10 220-240V  
1x75W HAGS/UB



**ERL** □ IP20



NOT INCLUDED:  
- Lampadina / Bulb

0,01 m<sup>3</sup>  
1,26 kg

GU10 220-240V  
1x5,5W



**LED**

**D27 F10**  
00 *Transparent*

GU5,3 12V  
1x50W HRGS



**ERL** ◇ IP20



NOT INCLUDED:  
- Lampadina / Bulb  
- Trasformatore / Transformer

0,01 m<sup>3</sup>  
1,28 kg

GU5,3 12V  
1x4W



**LED**

**D27 F39**  
00 *Transparent*

LED 700mA  
1x14W-40°  
WHITE 3000K  
1200lm Cri >80



**ERL** ◇ IP20

0,01 m<sup>3</sup>  
1,03 kg

INCLUDED:  
- LED / LED  
  
NOT INCLUDED:  
- Alimentatore / Driver

**LED**

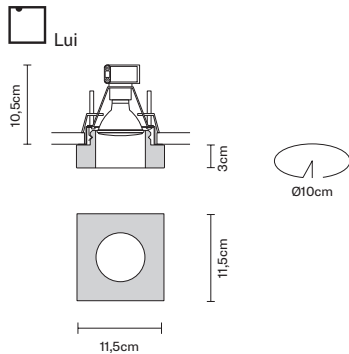

**D27 F11**  
35 *Polished stainless steel*

GU10 220-240V  
1x75W HAGS/UB



**ERL** □ IP20



NOT INCLUDED:  
- Lampadina / Bulb

0,01 m<sup>3</sup>  
1,18 kg

GU10 220-240V  
1x5,5W



**LED**

**D27 F12**  
35 *Polished stainless steel*

GU5,3 12V  
1x50W HRGS



**ERL** ◇ IP20



NOT INCLUDED:  
- Lampadina / Bulb  
- Trasformatore / Transformer

0,01 m<sup>3</sup>  
1,12 kg

GU5,3 12V  
1x4W



**LED**

**D27 F40**  
35 *Polished stainless steel*

LED 700mA  
1x14W-40°  
WHITE 3000K  
1200lm Cri >80



**ERL** ◇ IP20

0,01 m<sup>3</sup>  
1,23 kg

INCLUDED:  
- LED / LED  
  
NOT INCLUDED:  
- Alimentatore / Driver

**LED**



**FARETTI**

Pamio Design / Luca Scacchetti

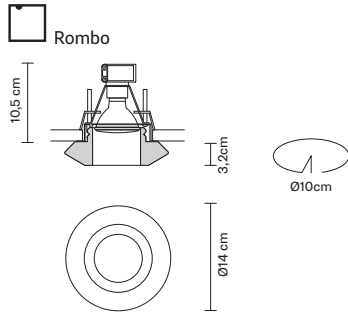

**code**      **electrification**      **technical info**      **accessories**

**D27 F56**  
**00 Transparent**  
**01 White**

GU10 220-240V  
 1x75W HAGS/UB

**LED** IP20 NOT INCLUDED:  
 - Lampadina / Bulb

0,01 m<sup>3</sup>  
 1,05 kg

GU10 220-240V  
 1x5,5W

**LED**

**D27 F57**  
**00 Transparent**  
**01 White**

GU5,3 12V  
 1x50W HRGS

**LED** IP20 NOT INCLUDED:  
 - Lampadina / Bulb  
 - Trasformatore / Transformer

0,01 m<sup>3</sup>  
 1,05 kg

GU5,3 12V  
 1x4W

**LED**

**D27 F59**  
**00 Transparent**  
**01 White**

LED 700mA  
 1x14W-40°  
 WHITE 3000K  
 1200lm Cri >80

**LED** IP20 INCLUDED:  
 - LED / LED

0,01 m<sup>3</sup>  
 1,05 kg

NOT INCLUDED:  
 - Alimentatore / Driver

**LED**

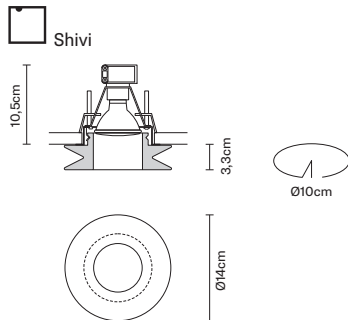

**D27 F01**  
**00 Transparent**  
**01 White**

GU10 220-240V  
 1x75W HAGS/UB

**LED** IP20 NOT INCLUDED:  
 - Lampadina / Bulb

0,01 m<sup>3</sup>  
 1,07 kg

GU10 220-240V  
 1x5,5W

**LED**

**D27 F02**  
**00 Transparent**  
**01 White**

GU5,3 12V  
 1x50W HRGS

**LED** IP20 NOT INCLUDED:  
 - Lampadina / Bulb  
 - Trasformatore / Transformer

0,01 m<sup>3</sup>  
 1,07 kg

GU5,3 12V  
 1x4W

**LED**

**D27 F31**  
**00 Transparent**  
**01 White**

LED 700mA  
 1x14W-40°  
 WHITE 3000K  
 1200lm Cri >80

**LED** IP20 INCLUDED:  
 - LED / LED

0,01 m<sup>3</sup>  
 1,12 kg

NOT INCLUDED:  
 - Alimentatore / Driver

**LED**



**FARETTI**

Pamio Design / Luca Scacchetti

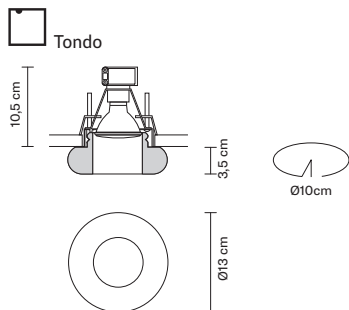

**code**      **electrification**      **technical info**      **accessories**

**D27 F61**      GU10 220-240V      **EAC** □ IP20      NOT INCLUDED:  
**00 Transparent**      1x75W HAGS/UB      (150° C) (0.5 m)      - Lampadina / Bulb  
**01 White**      

0,01 m<sup>3</sup>  
 1,32 kg

GU10 220-240V  
 1x5,5W



**LED**

**D27 F62**      GU5,3 12V      **EAC** ◇ IP20      NOT INCLUDED:  
**00 Transparent**      1x50W HRGS      (0.5 m)      - Lampadina / Bulb  
**01 White**      

0,01 m<sup>3</sup>  
 1,16 kg

GU5,3 12V  
 1x4W



**LED**

**D27 F64**      LED 700mA      **EAC** ◇ IP20      INCLUDED:  
**00 Transparent**      1x14W-40°      0,01 m<sup>3</sup>      - LED / LED  
**01 White**      WHITE 3000K      1,02 kg      NOT INCLUDED:  
                          1200lm CRI >80            - Alimentatore / Driver

**LED**



# FLOW

—

Nicola Design

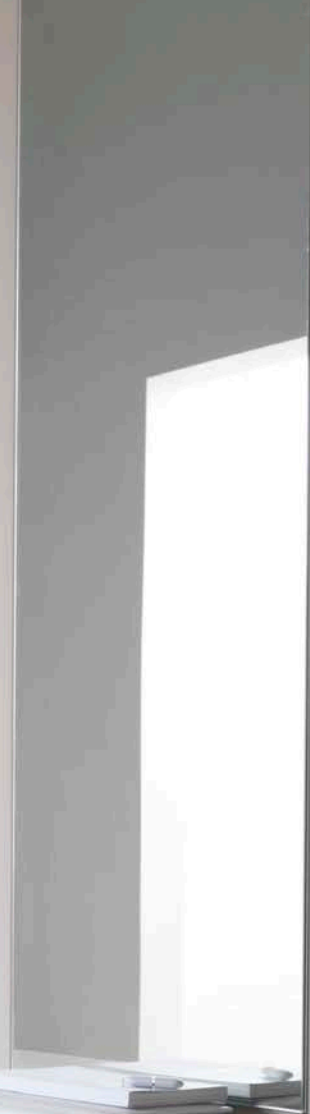

# CONCEPT

---

Flow nasce dalla volontà di Nicola Design di arredare ed illuminare con classe tutte le tipologie d'ambiente, dagli spazi domestici a quelli pubblici. Flow è infatti una serie di lampade in cristallo al piombo decorato da una raffinata tramatura che si adatta al meglio sia agli stili classici e ricchi di decorazioni ma anche a quelli moderni e minimali. E' stato dedicato uno studio più approfondito per valorizzare la luce di ogni lampada, infatti a seconda del colore del diffusore si può avere una variazione della luminosità: decisa e definita con il diffusore in cromo, diffusa morbida con il bianco, diretta con il colore trasparente.

Flow was created by Nicola Design as an elegant furnishing accessory and lighting fixture to be used anywhere, from the home to public spaces. The result is a range of lamps in lead crystal, decorated with a refined pattern that fits in perfectly with classic, richly decorated settings but also more contemporary and minimalist styles. An in-depth study was made to enhance the light produced by each lamp, leading to the possibility to vary the level of brightness depending on the colour of the diffuser: bold and defined for the chrome-plated diffuser, soft for the white diffuser and direct with the transparent diffuser.

Flow nasce de la voluntad de Nicola Design de decorar e iluminar con clase todos los tipos de ambientes incluyendo espacios domésticos y públicos. De hecho Flow es una serie de lámparas de cristal al plomo, decorado por una trama elegante, que se adapta de la mejor forma posible a los estilos clásicos y ricos de decoraciones pero también a los modernos y minimalistas. Se ha dedicado un estudio más detallado para valorizar la luz de cada lámpara y según el color del difusor la luminosidad cambia: decidida y marcada con el difusor de cromo, difusa y suave con el blanco y directa con el color transparente.

Flow nasce de la voluntad de Nicola Design de decorar e iluminar con clase todos los tipos de ambientes incluyendo espacios domésticos y públicos. De hecho Flow es una serie de lámparas de cristal al plomo, decorado por una trama elegante, que se adapta de la mejor forma posible a los estilos clásicos y ricos de decoraciones pero también a los modernos y minimalistas. Se ha dedicado un estudio más detallado para valorizar la luz de cada lámpara y según el color del difusor la luminosidad cambia: decidida y marcada con el difusor de cromo, difusa y suave con el blanco y directa con el color transparente.

Flow naît de la volonté de Nicola Design de décorer et d'éclairer toutes les typologies de pièces avec une touche de classe, qu'il s'agisse d'espaces domestiques ou de lieux publics. Flow est une série de lampes en cristal au plomb décoré par une trame raffinée qui s'adapte parfaitement aux styles classiques et riches en décorations, tout comme aux styles plus modernes et minimalistes. Une étude plus approfondie a été réalisée pour mettre en valeur la lumière de chaque lampe, car en fonction de la couleur du diffuseur, il est possible d'obtenir une variation de la luminosité: nette et définie avec le diffuseur en chrome, diffuse et tamisée avec le blanc, directe avec la couleur transparente.

Светильники Flow созданы дизайн-студией Nicola Design для оформления и освещения пространств различных типов и стилей, от домашнего интерьера до общественных мест. Flow – это коллекция светильников из свинцового кристалла с тонким изысканным рисунком, она прекрасно подходит как для классического богатого интерьера, так и для интерьера в стиле минимализм или модерн. Тщательное внимание уделено освещению каждой лампы, яркость которой меняется в зависимости от цвета рассеивателя: рассеиватель хромового цвета дает четкое и резкое освещение, белого цвета – мягкое и рассеяное освещение, прозрачный рассеиватель - прямое освещение.

# FLOW

---

La collezione è costituita da sospensioni, lampade da tavolo, parete e soffitto per interno. I diffusori sono disponibili in cristallo trasparente o verniciato internamente. I supporti metallici sono in cromo lucido. L'elettrificazione è a tensione di rete per lampade alogene.

La colección está compuesta por lámparas colgantes, lámparas de sobremesa, apliques y plafones de interior. Los difusores existen de cristal transparente o pintado internamente. Los soportes metálicos son de cromo brillante. La electrificación es con tensión de red para bombillas halógenas.

Die Kollektion besteht aus Hängelampen, Tisch-, Decken- und Wandlampen für innen und außen. Die Diffusoren sind in aus transparentem Kristallglas oder intern lackiert. Die Metallhalterungen sind glanzverchromt. Die Elektrifizierung erfolgt über Netzspannung bei Halogen-Lampen.

The collection is composed of pendant, table, wall and ceiling lamps for indoor use. The crystal diffusers are available either transparent or painted on the inside. The metal supports are in polished chrome. The lamp runs on mains power and is suitable for use with halogen bulbs.

La collection est constituée par des suspensions, des lampes de table, des appliques et des plafonniers pour intérieur. Les diffuseurs sont disponibles en cristal transparent ou verni à l'intérieur. Les supports métalliques sont réalisés en chrome poli. Lampes halogènes alimentées par la tension du réseau.

Коллекция состоит из подвесных, настольных, напольных, потолочных и настенных светильников для внутренних помещений. Рассеиватели из прозрачного или покрытого внутри лаком кристалла. Металлическая структура из блестящего хрома. Электрическая часть рассчитана на галогеновые лампы от сетевого напряжения.





**FLOW**  
Nicola Design

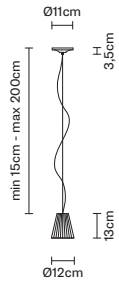

**code**

**electrification**

**technical info**

**accessories**

**D87 A01**  
00 Transparent  
01 White

G9 220-240V  
1x48W HSGS



**EAC** IP20  
0,012 m<sup>3</sup>  
1,60 kg

INCLUDED:  
- Kit per decentramento / *Off-center*  
cable fastener

NOT INCLUDED:  
- Lampadina / *Bulb*

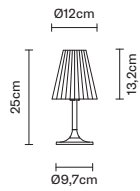

**D87 B01**  
00 Transparent  
01 White

G9 220-240V  
1x48W HSGS



**EAC** IP20  
0,012 m<sup>3</sup>  
1,59 kg

NOT INCLUDED:  
- Lampadina / *Bulb*

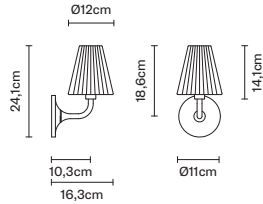

**D87 D01**  
00 Transparent  
01 White

G9 220-240V  
1x48W HSGS



**EAC** IP20  
0,012 m<sup>3</sup>  
1,64 kg

NOT INCLUDED:  
- Lampadina / *Bulb*

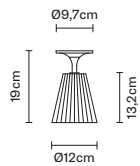

**D87 E01**  
00 Transparent  
01 White

G9 220-240V  
1x48W HSGS



**EAC** IP20  
0,012 m<sup>3</sup>  
1,58 kg

NOT INCLUDED:  
- Lampadina / *Bulb*

# GIRO

—  
Fromfjord



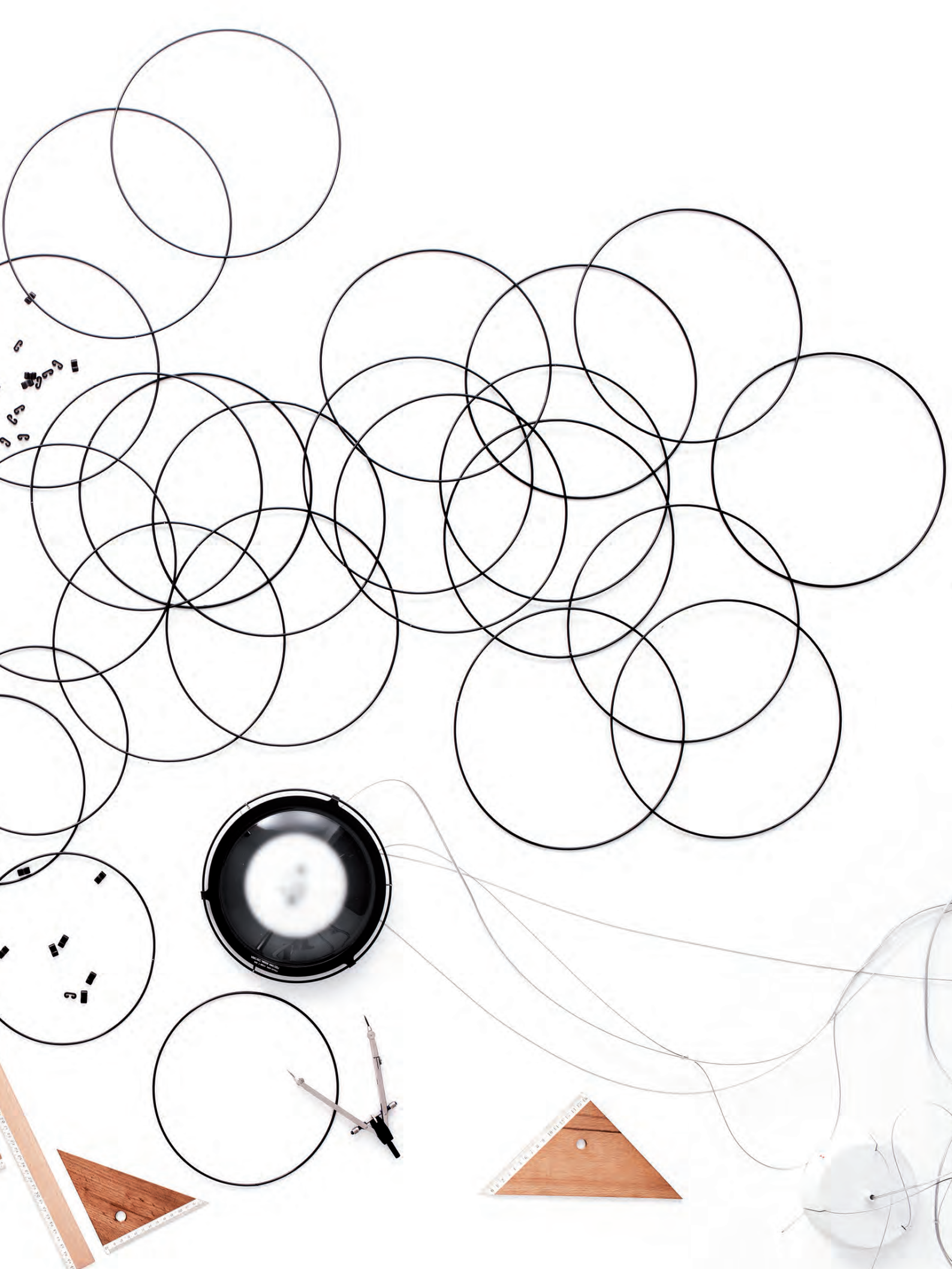



## CONCEPT

---

Definire lo spazio in cui si trovano è una delle funzioni principali delle lampade installate in grandi ambienti. Questa è l'idea centrale da cui è partito studio Formfjord. L'obiettivo dei designers era quindi di creare una lampada abbastanza grande, ma, allo stesso tempo, aperta e leggera, ariosa. La soluzione è stata trovata nella semplicità e nella delicatezza dei sottili anelli d'acciaio e della loro qualità grafica, caratteristiche che hanno attirato l'attenzione degli autori, tanto da farli diventare parte essenziale del progetto. Queste sospensioni sono degli oggetti scultorei ricercati e leggeri.

The purpose of lamps installed in vast spaces is to define the space around them. This is the main idea for the design by the Formfjord studio. The aim of the designers was to create a lamp which was sufficiently large, yet at the same time open, lightweight and airy. The solution was found in the simplicity and delicacy of thin steel rings, and their graphic shape, which attracted the attention of the designers who made these characteristics the main elements of this project, creating pendant lights which are sophisticated, lightweight sculptured objects.

Definir el espacio donde se encuentran es una de las funciones principales de las lámparas instaladas en los grandes ambientes. Con esta idea central ha trabajado el estudio Formfjord. El objetivo de los diseñadores era, por consiguiente, crear una lámpara lo suficientemente grande pero, al mismo tiempo, abierta y ligera, espaciosa. La solución se encontró en la sencillez y en la delicadeza de los anillos finos de acero y de sus calidades gráficas, unas características que han atraído la atención de los autores, hasta convertirlas en parte esencial del proyecto. Estas lámparas colgantes son objetos esculturales elegantes y ligeros.

Die Definition des Raumes, in dem sie sich befinden, ist eine der zentralen Funktionen der in großen Räumen installierten Lampen. Dies ist die zentrale Idee, von der das Studio Formfjord ausgegangen sind. Das Ziel der Designer war der Entwurf einer großen, gleichzeitig jedoch auch offenen und leichten, luftigen Lampe. Die Lösung fanden sie in der Schlichtheit und Zartheit von dünnen Stahlringen und ihrer grafischen Qualität. Diese Eigenschaften erweckten das Interesse der Gestalter, die diese Ringe zu einem essentiellen Bestandteil ihres Projekts machten. Diese Hängelampen sind ausserlesene und leichte Skulpturobjekte.

Une des fonction principales des lampes installées dans de grandes pièces est celle de définir l'espace dans lequel elles se trouvent. Voilà l'idée de départ du studio Formfjord. L'objectif des designers était donc de créer une lampe assez grande, mais en même temps, ouverte et légère, aérée. La solution a été trouvée dans la simplicité et la délicatesse des anneaux très fins en acier et de leur qualité graphique. Ces caractéristiques ont attiré l'attention des auteurs, au point de les considérer comme une partie essentielle du projet. Ces suspensions sont des objets sculpturaux recherchés et légers.

Ограничить пространство, в котором они расположены, является одной из основных функций ламп для больших пространств. Это была основная идея дизайн-студии Формфjord, когда они создали подвесные лампы Giro. Цель дизайнеров была создание довольно большой, но в то же время открытой, легкой, воздушной лампы. Решение было найдено в легкости и простоте тонких стальных колец и в их графической характеристике, которая настолько привлекла авторов, что они стали неотъемлемой частью этого проекта. Эти подвесные лампы – легкие и утонченные скульптуры.

# GIRO

La collezione è costituita da sospensioni per interno, disponibili in due dimensioni, entrambe composte da 32 anelli di diversi diametri, uniti in maniera da formare un volume sferico. Anche le finiture sono due: verniciato bianco o grigio antracite. La fonte luminosa può essere installata secondo il proprio gusto o esigenza all'interno della struttura metallica. L'elettrificazione è a tensione di rete per LED. La lampada viene inviata in una normale scatola rettangolare, di dimensioni ridotte, rendendola ottimale dal punto di vista logistico. Può essere facilmente installata in loco.

La colección está constituida por lámparas colgantes de interior, disponibles en dos tamaños, ambos compuestos por 32 anillos con distintos diámetros, unidos para formar un volumen esférico. También los acabados son dos: pintado blanco o gris antracita. La fuente luminosa se puede instalar según los gustos personales o las exigencias dentro de la estructura metálica. La electrificación es con tensión de red para LED. La lámpara se envía en una caja normal rectangular con dimensiones reducidas, por lo que es óptima desde el punto de vista logístico. Instalación facilitada in situ.

Die Kollektion besteht aus Hängelampen für Innenbereiche und ist in zwei Größen verfügbar, jedes Modell setzt sich aus 32 Ringen von unterschiedlichen Abmessungen zusammen, die so miteinander verbunden sind, dass sie ein sphärisches Volumen darstellen. Auch die Feinbearbeitungen liegen in zwei Variationen vor: weiß lackiert oder anthrazit. Die Lichtquelle kann je nach Geschmack oder Bedarf im Inneren der Metallstruktur installiert werden. Die Elektrifizierung ist LED mit Netzspannung. Die Lampe wird in einer normalen, rechteckigen Kiste verschickt. Ihre Dimensionen sind dazu reduziert, was sie ideal auch unter logistischen Aspekten macht. Sie kann mit Leichtigkeit an ihrem Platz installiert werden.

The collection consists of hanging lamps for indoor use, available in two sizes, both made up of 32 rings of varying diameter that are joined together to form a spherical shape. There are also two available finishes: polished white or anthracite grey. The choice of light source inside the metallic structure depends on personal tastes and needs. The lamp runs on mains power and is suitable for use with LED bulbs. The lamp is delivered in a small, regular rectangular box, making it very efficient from a logistic point of view. It can be easily installed at destination.

La collection est constituée par des suspensions pour intérieur, disponibles en deux dimensions, toutes deux composées de 32 anneaux de divers diamètres, unis de manière à former un volume sphérique. Deux finitions sont proposées: verni blanc ou gris anthracite. La source lumineuse peut être installée selon son choix ou son exigence à l'intérieur de la structure métallique. Les LED sont alimentées par la tension du réseau. La lampe est livrée dans une boîte normale rectangulaire, de dimensions réduites, pour faciliter la logistique. Elle peut être aisément installée sur place.

Коллекция состоит из подвесных ламп для внутренних помещений, в двух размерах. Лампа состоит из 32 колец разных диаметров, которые соединяются, создавая сферический объем. Лампа представлена в двух цветах: с белым или антрацитовым лаковым покрытием. Источник света может быть установлен внутри металлической структуры по собственному усмотрению и надобности. Электрическая часть рассчитана на светодиодную лампу от сетевого напряжения. Лампа упакована в обычной прямоугольной коробке небольших размеров для оптимальной логистики. Она легка в сборке и монтаже.



**GIRO**  
Fromfjord

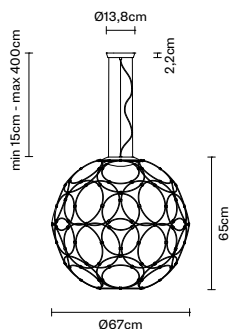

**code**

**electrification**

**technical info**

**accessories**

**F30 A01**  
01 White  
21 Anthracite

LED 220-240V  
1x17W-120°  
WHITE 3000K  
1850lm CRI >80

**EAC** IP20  
0,012 m<sup>3</sup>  
2,96 kg

INCLUDED:  
- LED / LED



Dimmerabile TRIAC / Dimmable TRIAC

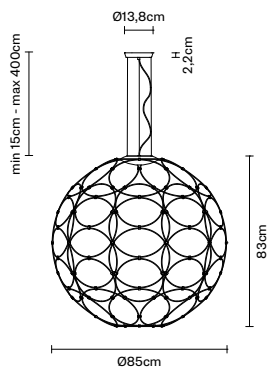

**F30 A03**  
01 White  
21 Anthracite

LED 220-240V  
1x17W-120°  
WHITE 3000K  
1850lm CRI >80

**EAC** IP20  
0,019 m<sup>3</sup>  
3,06 kg

INCLUDED:  
- LED / LED



Dimmerabile TRIAC / Dimmable TRIAC

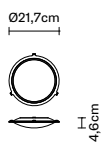

**F30 Z01**  
01 White  
21 Anthracite

LED 220-240V  
1x17W-120°  
WHITE 3000K  
1850lm CRI >80

**EAC** IP20  
0,019 m<sup>3</sup>  
0,98 kg

INCLUDED:  
- LED / LED



Blocco luce aggiuntivo. Dimmerabile TRIAC / Additional light source. Dimmable TRIAC

# GIUNCO

—

Marc Sadler









# CONCEPT

---

La collezione si ispira alla natura, all'osservazione della leggerezza ed eleganza di elementi, quali un verde prato o un canneto di giunchi mossi dal vento. Marc Sadler schizzando quest'idea ha rappresentato dei semplici ma forti segni grafici che hanno poi caratterizzato il progetto. L'ingegnerizzazione ha cercato di sviluppare il prodotto finale dando anche una forma che permettesse la modularizzazione. Traendo sempre spunto da questi elementi naturali presi in gruppo, utilizzando quindi più pezzi della stessa piantana, si è voluto dare la possibilità di ricreare, per esempio, l'atmosfera di un raffinato giardino zen, in casa o nella reception di un wellness center.

This collection is inspired by nature, the observation of the lightness and elegance of elements such as a green meadow or bull-rushes dancing in the wind. When sketching this idea, Marc Sadler conveyed the simple yet strong graphic elements which became an essential part of the design. The technical side of the project aimed at creating a final product which a modular shape. By taking inspiration from the way in which these elements are often grouped together in nature, the aim was to allow the creation, for example, of the atmosphere of an elegant Zen garden by grouping together several of the floor lamps, in the home or in the reception area of a spa centre.

La colección se inspira en la naturaleza, en la observación de la ligereza y elegancia de los elementos, tales como un prado verde o un cañaveral de juncos movidos por el viento. Marc Sadler al perfilar esta idea ha representado signos gráficos sencillos pero marcados, que luego han caracterizado el proyecto. La ingeniería ha intentado desarrollar el producto final a través de una forma también que permitiese la modularidad. A partir de estos elementos naturales tomados en grupo y, por consiguiente, usando varias piezas del mismo pie, se ha apostado por la posibilidad de recrear, por ejemplo, la atmósfera de un jardín refinado zen, en casa o en la recepción de un centro wellness.

Die Kollektion inspiriert sich an der Natur, der Beobachtung der Leichtigkeit und Eleganz der Elemente, wie eine grüne Wiese oder windbewegtes Schilf. Marc Sadler hat im Entwurf dieser Idee einfache, aber starke graphische Zeichen dargestellt, die dieses Projekt dann ausgezeichnet haben. Die Konstruktionstechnik hat versucht, das Endprodukt mit einer Form zu entwickeln, die auch eine Modularisierung ermöglicht. Man inspirierte sich an diesen natürlichen Gruppenelementen und verwendete somit mehrere Teile derselben Bodenlampe, so konnte zum Beispiel die Möglichkeit gegeben werden, die Atmosphäre eines eleganten Zen-Gartens im Haus oder im Empfangsbereich eines Wellnesscenters wiederzuspiegeln.

La collection s'inspire de la nature, de l'observation de la légèreté et de l'élégance des éléments, comme un pré vert ou une cannaie de joncs agités par le vent. Sur base de cette idée, Marc Sadler a représenté des signes graphiques simples, mais forts, qui ont fortement caractérisé ce projet. L'ingénierie a essayé de développer le produit final en créant une forme qui permette la modularisation. En se basant sur ces éléments naturels pris en groupe et en utilisant plusieurs pièces du même lampadaire, on a voulu donner la possibilité de recréer, par exemple, l'atmosphère d'un jardin zen raffiné, chez soi ou dans un hall de réception d'un centre de bien-être.

Коллекция черпает вдохновение в природе, наблюдая за легкостью и грациозностью ее элементов, например как ветер качает траву или ветки тростника. Марк Садлер набросал простые но графически сильные эскизы, которые послужили основой для этого проекта. Инженеры разработали конечный вариант торшера, придав ему форму, позволяющую разделить его на модули. Восхищаясь и вдохновляясь природой, используя многие составляющие торшера, дизайнер хотел воссоздать атмосферу изысканного сада дзен, в домашнем интерьере, или например в зоне ресепшн салона красоты.

# GIUNCO

La collezione è composta da tre tipologie di lampade da terra per interno ed esterno. La prima versione è una piantana composta da steli multipli che fungono da diffusore; sono in materiale plastico bianco caricato con fibra di vetro con all'estremità la sorgente luminosa. La base è una struttura in metallo verniciato bianco a polveri. L'elettrificazione, a tensione di rete, è a doppio sistema LED (24Vdc), provvisto di accensione separata. La seconda versione prevede degli steli singoli dello stesso materiale disponibili in diverse lunghezze e utilizzabili in ambienti esterni con picchetto. La terza versione è in ottone e rame brunito con emissione di luce diretta.

La colección se compone de tres tipos de lámpara de pie para interiores y exteriores. La primera versión es una planta compuesta de múltiples tallos que actúan como difusores; son de un material plástico blanco cargado de fibra de vidrio en el extremo de la fuente de luz. La base es una estructura de metal pintado con polvo de blanco. La electrificación, el voltaje de red, es la del sistema LED doble (24Vdc), provisto de interruptor independiente. La segunda versión incluye tallos individuales del mismo material, disponible en diferentes longitudes y se puede utilizar al aire libre con piqueta. La tercera versión es de latón y cobre bruñido con una iluminación directa.

Die Kollektion besteht aus drei Arten von Stehleuchten für den Innen- und Außenbereich. Die erste Version besteht aus mehreren zusammengesetzten Teilen, die über eine Diffusorfunktion verfügen. Sie sind aus weißem Kunststoff an deren Ende die Lichtquelle angebracht ist. Die Basis besteht aus weiß lackiertem, pulverisiertem Metall. Die Stromversorgung erfolgt durch normale Netzspannung und besteht aus einem Dual-LED-System (24 VDC), mit separater Zündung. Die zweite Version besteht aus nur einer Stele und ist aus dem gleichen Material gefertigt. Es ist in verschiedenen Längen erhältlich und kann im Außenbereich verwendet werden. Die dritte Version besteht aus poliertem Messing und Kupfer und ermöglicht eine direkte Beleuchtung.

The collection is composed of three different versions of floor lamps for indoor and outdoor use. The first version includes multiple stalks that act as light diffusers, made of white plastic reinforced with fibreglass, with a light source on the tip. The metallic white base is spray-painted. The lamp runs on mains voltage with a double LED lighting system (24Vdc), fitted with a separate switch. The second version is composed of single stalks of the same material available in different heights and fitted with a metal stake for outdoor use. The last version is made out of burnished brass and copper with direct light emission.

La collection se compose de trois types de lampadaires pour l'intérieur et l'extérieur. La première version est un lampadaire constitué de multiples tiges qui agissent comme un diffuseur; elles sont en matière plastique blanc constituées de fibre de verre conduisant la source lumineuse jusqu'à leur extrémité. La base est une structure en métal peint en blanc. L'électrification, à la tension du réseau, est un système à double LED (24Vdc), fourni avec allumage séparé. La deuxième version est constituée de tiges dans le même matériau, disponibles en différentes longueurs et utilisables dans des environnements extérieurs avec un pic. La troisième version est en laiton et cuivre brun avec un éclairage direct.

Коллекция включает в себя три вида напольных светильников для дома и сада. Первый вариант представляет собой опору из нескольких стержней, выступающих в качестве диффузора света. Стержни выполнены из белой пластмассы со стекловолокном и оснащены источником света на конце. Основание сделано из металла, окрашенного в белый цвет. Электрификация за счет напряжения сети осуществляется через двойную систему LED (24Vdc), оснащенную отдельным подключением. Второй вариант предусматривает отдельные стержни различной длины, выполненные из этого же материала и оборудованные штырями заземления, и подходит для использования вне помещения. Третий вариант выполнен из латуни и оксидированной меди с прямым испусканием света.



**GIUNCO**  
Marc Sadler

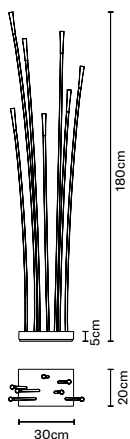

**code**      **electrification**      **technical info**      **accessories**

**F14 C01**  
01 White

LED 220-240V  
7x3.5W  
WHITE 3000K  
1500lm Cri >80

**EAC**  **IP20**  
0,19 m<sup>3</sup>  
7,83 kg

INCLUDED:  
- LED / LED  
- Doppia accensione / Double switch  
- Alimentatore elettronico / Electronic driver



Diffusori fissi / Fixed diffusers

**F14 C03**  
01 White

LED 220-240V  
7x3.5W  
WHITE 3000K  
1500lm Cri >80

**EAC**  **IP65**  
0,19 m<sup>3</sup>  
7,60 kg

INCLUDED:  
- LED / LED  
- Alimentatore elettronico / Electronic driver



Diffusori fissi / Fixed diffusers



**NEW!** **F14 C11**  
01 White

LED 24Vdc  
1x3.5W-120°  
WHITE 3000K  
220lm Cri 85

**EAC**  **IP65**

INCLUDED:  
- LED / LED  
  
NOT INCLUDED:  
- Alimentatore / Driver



**NEW!** **F14 C13**  
01 White

LED 24Vdc  
1x3.5W-120°  
WHITE 3000K  
220lm Cri 85

**EAC**  **IP65**

INCLUDED:  
- LED / LED  
  
NOT INCLUDED:  
- Alimentatore / Driver





**GIUNCO**  
Marc Sadler

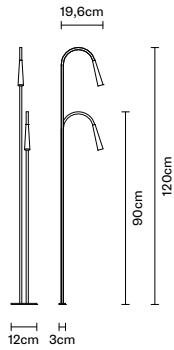

**NEW!** **F14 C51**  
01 White

LED 700mA  
2x3W-120°  
WHITE 3000K  
230lm Cri 80

**EAC** III IP65

INCLUDED:  
- LED / LED  
NOT INCLUDED:  
- Alimentatore / Driver

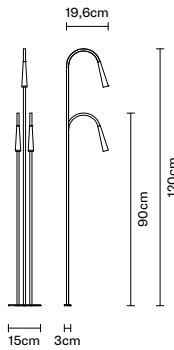

**NEW!** **F14 C53**  
01 White

LED 700mA  
3x3W-120°  
WHITE 3000K  
230lm Cri 80

**EAC** III IP65

INCLUDED:  
- LED / LED  
NOT INCLUDED:  
- Alimentatore / Driver



**NEW!** **F14 Z01 C2**

**EAC** IP65

Staffa per fissaggio. Per F14C5114 e F14C5314 / Support clamp. For F14C5114 and F14C5314

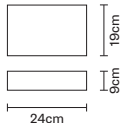

**NEW!** **F14 Z10**

**EAC** IP65

NOT INCLUDED:  
- Spots / Spots

Box di alimentazione 24Vdc da esterno. Max 1 lampada, non dimmerabile. Per F14C1114 e F14C1314 / Outdoor power supply box for 24Vdc lights. Max 1 lamp, not dimmable. For F14C1114 and F14C1314

**NEW!** **F14 Z11**

**EAC** IP65

NOT INCLUDED:  
- Spots / Spots

Box di alimentazione 700mA da esterno. Max 1 lampada, non dimmerabile. Per F14C5114 e F14C5314 / Outdoor power supply box for 700mA lights. Max 1 lamp, not dimmable. For F14C5114 and F14C5314

# GLU

—

Pellegrini+Mengato Design

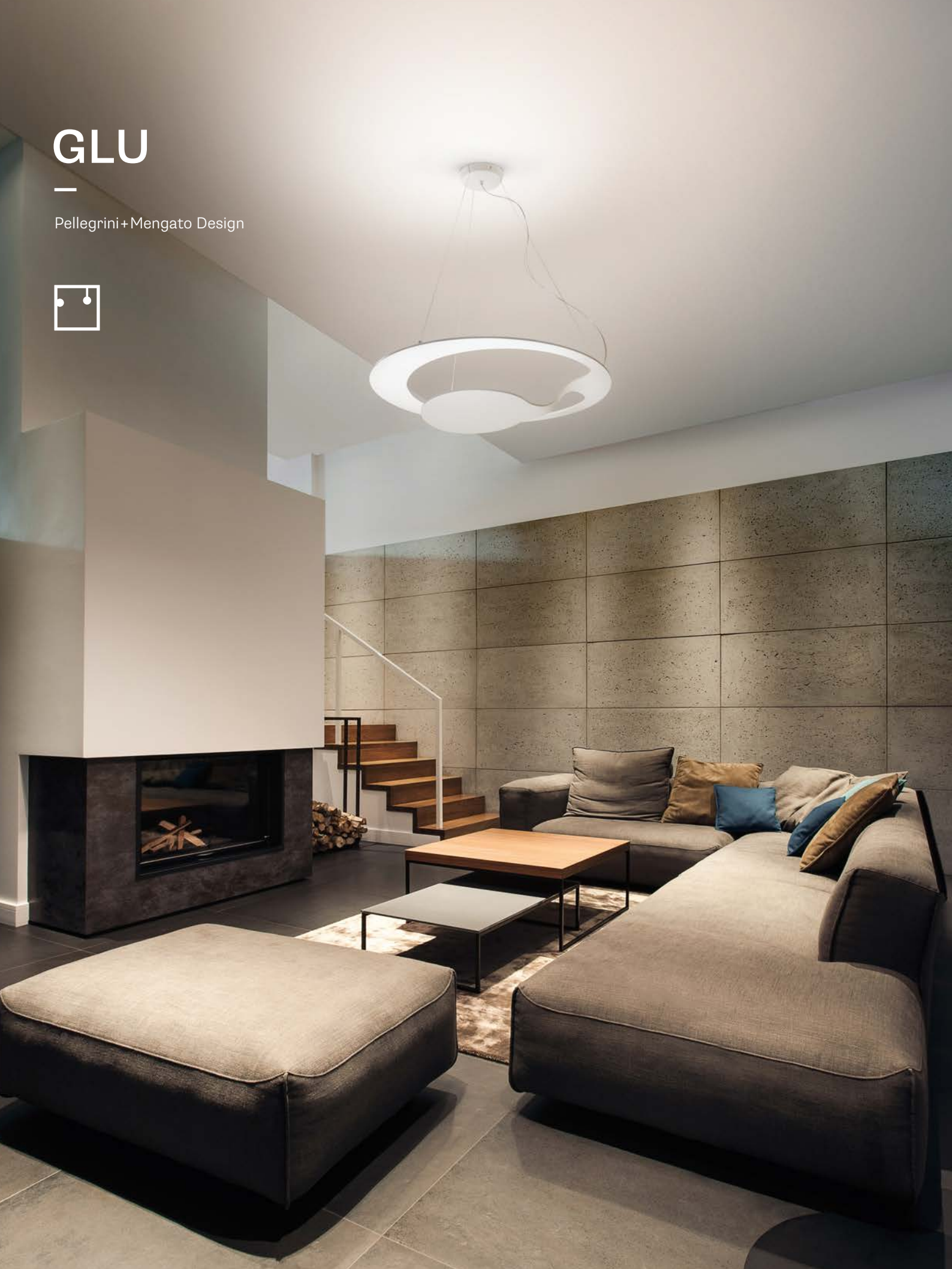



## CONCEPT

---

**Glu, disegnata da Pellegrini+Mengato Design, nasce dall'immagine di un satellite che ruota attorno ad un pianeta, un corpo dinamico e in perenne movimento che vuole quasi fuoriuscire dalla sua orbita, ma alla quale ne rimane sempre legato. La geometria è definita più nella parte sottratta che dal pieno della materia: infatti è il vuoto centrale, creato dal taglio laser del sottile disco, che dona a Glu il suo peculiare effetto di forma e luce e la rende leggera ed equilibrata. L'emissione indiretta della luce enfatizza ulteriormente il contrasto tra vuoto e pieno, e crea degli interessanti effetti di luce e ombra.**

The inspiration for Glu, designed by Pellegrini+Mengato Design, came from the rotation of a satellite around a planet, a dynamic element in continuous movement, trying to escape from its orbit, but never breaking away from this bond. The geometrical shape is defined not so much by the full part but by the central emptiness, created by the laser cut of the thin disk which gives Glu its particular shape and light effect, making it lightweight and balanced. The indirect light produced further emphasises the contrast between emptiness and fullness and creates interesting light and shadow effects.

Glu, diseñada por Pellegrini+Mengato Design, surge a partir de la imagen de un satélite que gira alrededor de un planeta, un cuerpo dinámico y en movimiento constante que quiere casi salirse de su órbita, pero de la que no se puede desligar. La geometría se acentúa más en la parte ausente y no en la materia plena: de hecho es el vacío central, creado por el corte al láser del disco delgado, que regala a Glu su peculiar efecto de forma y luz y también ligereza y equilibrio. La emisión indirecta de la luz enfatiza aún más el contraste entre vacío y lleno con lo que se crean efectos interesantes de luz y sombra.

Glu der Designer Pellegrini+Mengato Design, entsteht aus der Imagination eines Satelliten, der um einen Planeten rotiert. Ein dynamischer Körper, der konstant in Bewegung ist und seinen Orbit geradezu verlassen möchte, mit dem er jedoch ständig verbunden bleibt. Die Geometrie ist mehr durch das entzogene, als das vollständige Glied der Materie definiert: Es ist gerade die zentrale Leere, erzeugt durch den Laserschnitt der feinen Scheibe, welche Glu einen ganz eigenen Effekt an Form und Licht verleiht und die Lampe leicht und ausgewogen erscheinen lässt. Die Verbreitung eines indirekten Lichts betont den Kontrast zwischen Leere und Vollständigkeit noch mehr und erzeugt interessante Effekte von Licht und Schatten.

Glu, dessinée par Pellegrini+Mengato Design, a été créée à partir de l'image d'un satellite qui tourne autour d'une planète, un corps dynamique et en mouvement perpétuel qui veut presque sortir de son orbite, mais auquel il veut rester lié. La géométrie est plus définie dans la partie dépourvue de matière: en effet, le vide central, créé par la découpe laser du disque très fin confère à Glu un effet de forme et de lumière particulier, ce qui la rend légère et équilibrée. La diffusion indirecte de la lumière accentue d'autant plus le contraste entre le vide et le plein et crée des jeux d'ombre et de lumière très intéressants.

Glu создана дизайнерами Pellegrini+Mengato Design, отталкиваясь от идеи спутника, который кружится вокруг планеты, его динамическое тело находится в постоянном движении, хочет выйти из орбиты, но остается в постоянном притяжении. Геометрия этой лампы видна больше в ее пустой части, чем в полноте материи: центральная пустота лампы, созданная лазерной резкой тонкого диска, придает ей особенный эффект формы и света, а также легкий и сбалансированный вид. Непрямое излучение света дополнительно подчеркивает контраст между пустотой и полнотой и создает интересную игру светотени.

# GLU

La collezione si costituisce di una sospensione e di una lampada da parete per interno. La struttura è realizzata in alluminio verniciato bianco opaco. L'elettrificazione è a tensione di rete per LED.

La colección está constituida por una lámpara colgante y por un aplique de interior. La estructura está realizada en aluminio pintado de color blanco mate. La electrificación es con tensión de red para LED.

Die Kollektion besteht aus einer Hänge- und einer Wandlampe für innen. Die Struktur ist aus mattweiß lackiertem Alu. Die Elektrifizierung erfolgt über Netzspannung bei LED-Lampen.

The collection is made up of one hanging lamp and one wall lamp, both for indoor use. The main structure is in matt white painted aluminium. The lamp runs on mains power and is suitable for use with LED bulbs.

La collection est constituée par une suspension et une applique murale pour intérieur. La structure est réalisée en aluminium verni blanc mat. Les LED sont alimentées par la tension du réseau.

Коллекция состоит из подвесной лампы и настенной лампы для внутренних помещений. Выполнена из алюминия с матовым белым покрытием. Электрическая часть рассчитана на светодиодную лампу от сетевого напряжения.



**GLU**

Pellegrini+Mengato Design

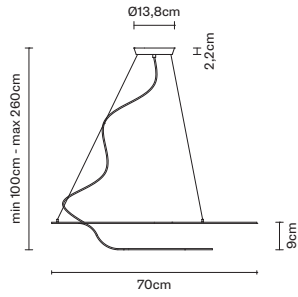

**code**

**electrification**

**technical info**

**accessories**

**F31 A01**  
01 White

LED 220-240V  
2x17W-120°  
WHITE 3000K  
3700lm Cri >80

**EAC** IP20  
0,066 m<sup>3</sup>  
6,79 kg

INCLUDED:  
- LED / LED



Dimmerabile TRIAC / Dimmable TRIAC

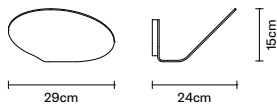

**F31 D01**  
01 White

LED 220-240V  
1x17W-120°  
WHITE 3000K  
1850lm Cri >80

**EAC** IP40  
0,018 m<sup>3</sup>  
2,21 kg

INCLUDED:  
- LED / LED



Dimmerabile TRIAC / Dimmable TRIAC



# HUNGRY

—  
Ali Siahvoshi

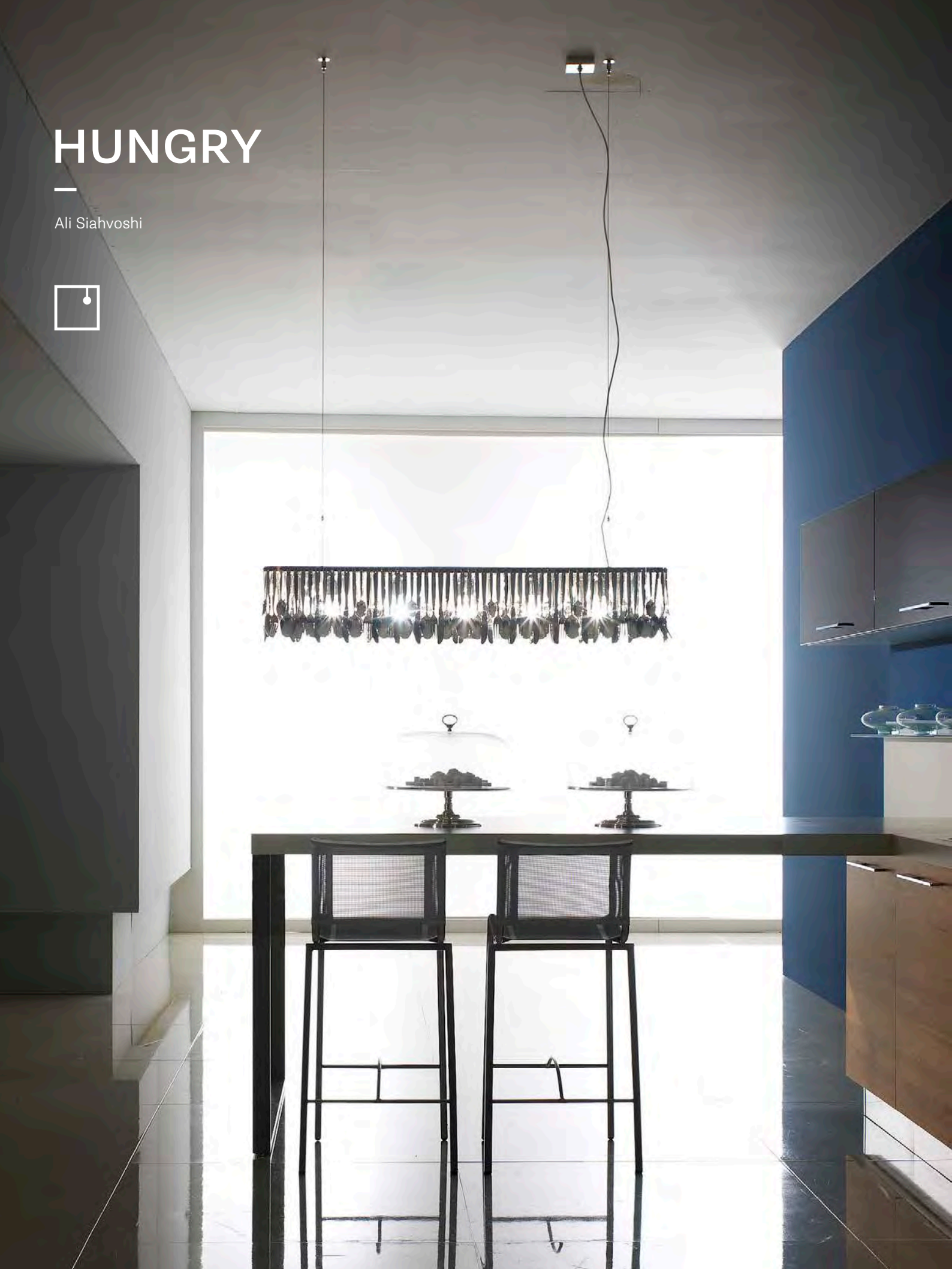

## CONCEPT

---

Secondo Ali Siahvoshi trasformare oggetti comuni in apparecchi d'illuminazione può dare loro una prospettiva migliore ed essere fonte di divertimento. Nel caso di questa collezione, più che guardare ad una forma nuova e più attrattiva, egli trova più interessante osservare cosa esiste già, in questo caso delle semplici posate, e trovarvi nuove applicazioni. Il risultato è che ad oggetti comuni, che riteniamo scontati, può essere dato un nuovo look o un nuovo scopo e la possibilità di un ciclo di vita più lungo. Questa lampada deve avvicinarsi alla gente, essere positiva, suscitare stupore e gioco.

According to Ali Siahvoshi, transforming common objects into lighting fixtures allows them to be put to better use in addition to the fun aspect. In this particular collection, rather than looking for a new, more attractive shape, he found it more interesting to observe any existing traits, in this case simple cutlery, and to find new uses for them. This results in the opportunity to give common objects which we take for granted a new look and purpose, and even a new lease of life. This lamp has to come closer to people, strike a positive note, create awe and amusement.

Según Ali Siahvoshi, transformar objetos comunes en aparatos de iluminación puede regalarles una perspectiva mejor y convertirse en una fuente de diversión. Hablando de esta colección, más que mirar hacia una forma nueva y más atractiva, le interesa más observar lo que existe, en este caso cubiertos sencillos, y hallar para ello nuevas aplicaciones. El resultado es que objetos comunes, que consideramos así sin más, pueden adquirir un nuevo look o un nuevo objetivo y la posibilidad de un ciclo de vida más largo. Esta lámpara ha de acercarse a la gente, ser positiva, despertar asombro y dar juego.

Laut Ali Siahvoshi kann die Umwandlung gemeiner Gegenstände in Beleuchtungsgeräte diesen eine bessere Prospektive verleihen und unterhaltend sein. In dieser Kollektion schaut er weniger auf die neue und attraktive Form, sondern betrachtet, was schon besteht, in diesem Fall einfaches Besteck, das neue Anwendungen erfährt. Das Ergebnis ist, dass wir gemeinen Gegenständen, die wir für selbstverständlich halten, einen neuen Look oder Zweck geben, und somit die Möglichkeit eines längeren Lebenszyklus. Diese Lampe muss sich den Menschen nähern, positiv sein, Überraschung und Spiel hervorrufen.

Selon Ali Siahvoshi, transformer des objets communs en corps d'éclairage peut leur donner une meilleure perspective et être une source de divertissement. Dans le cas de cette collection, plus que regarder une nouvelle forme attrayante, le designer trouve plus intéressant d'observer des choses qui existent déjà, dans ce cas, de simples couverts, et de leur trouver de nouvelles applications. Le résultat est que l'on peut offrir un nouveau look ou une nouvelle fonction inattendue à des objets communs, tout en prolongeant leur cycle de vie. Cette lampe doit être proche des gens, être positive, susciter étonnement et amusement.

Дизайнер Ali Siahvoshi верит, что можно превратить предметы обихода в светильники, дать им новую перспективу и возможность развлечь нас. В данной коллекции мы не смотрим на новую и необычную форму, а на то, что уже существует, например столовые приборы, и находим им новое применение. В результате мы можем дать новый образ и цель этим предметам обихода и продлить их жизненный цикл. Этот светильник должен приблизиться к людям, быть позитивным, изумляющим и развлекательным предметом интерьера.

# HUNGRY

La collezione è costituita da sospensioni per interno, di due diverse misure. La struttura metallica è in cromo lucido. Gli inserti di decoro sono set di posate in acciaio inox. L'elettrificazione è a tensione di rete per lampade alogene.

The collection is composed of hanging lamps for indoor use in two different sizes. The metallic structure is in polished chrome. The decorative inserts are cutlery sets in stainless steel. The lamp runs on mains power and is suitable for use with halogen bulbs.

La colección está constituida por lámparas colgantes de interior en dos tamaños distintos. La estructura metálica es de cromo brillante. Los elementos decorativos son juegos de cubiertos de acero inoxidable. La electrificación es con tensión de red para bombillas halógenas.

Die Kollektion besteht aus Hängelampen in zwei verschiedenen Abmessungen für Innenbereiche. Die Metallstruktur ist aus Glanzchrom. Die Deko-Einsätze sind Bestecksets aus Edelstahl. Die Elektrifizierung erfolgt über Netzspannung bei Halogen-Lampen.

La collection est constituée par des suspensions pour intérieur. La structure métallique est en chrome poli. Les éléments de décoration sont des ensembles de couverts en acier inox. Les lampes halogènes sont alimentées par la tension du réseau.

Коллекция состоит из подвесных ламп для внутренних помещений, в двух размерах. Металлическая структура из блестящего хрома. Декоративные элементы – столовые приборы из нержавеющей стали. Электрическая часть рассчитана на галогеновые лампы от сетевого напряжения.



**HUNGRY**  
Ali Siahvoshi

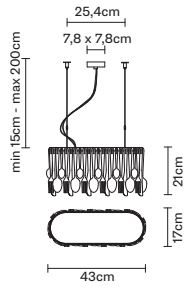

**code**

**electrification**

**technical info**

**accessories**

**D76 A01**  
15 Chrome

E14 220-240V  
3x8W FBC

**EAC** IP20  
0,034 m<sup>3</sup>  
4,52 kg

NOT INCLUDED:  
- Lampadina / Bulb



E14 220-240V  
3x3,5W

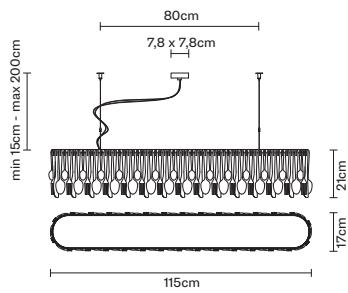

**D76 A03**  
15 Chrome

E27 220-240V  
5x11W FBG

**EAC** IP20  
0,109 m<sup>3</sup>  
11,21 kg

NOT INCLUDED:  
- Lampadina / Bulb



E27 220-240V  
5x9,5W

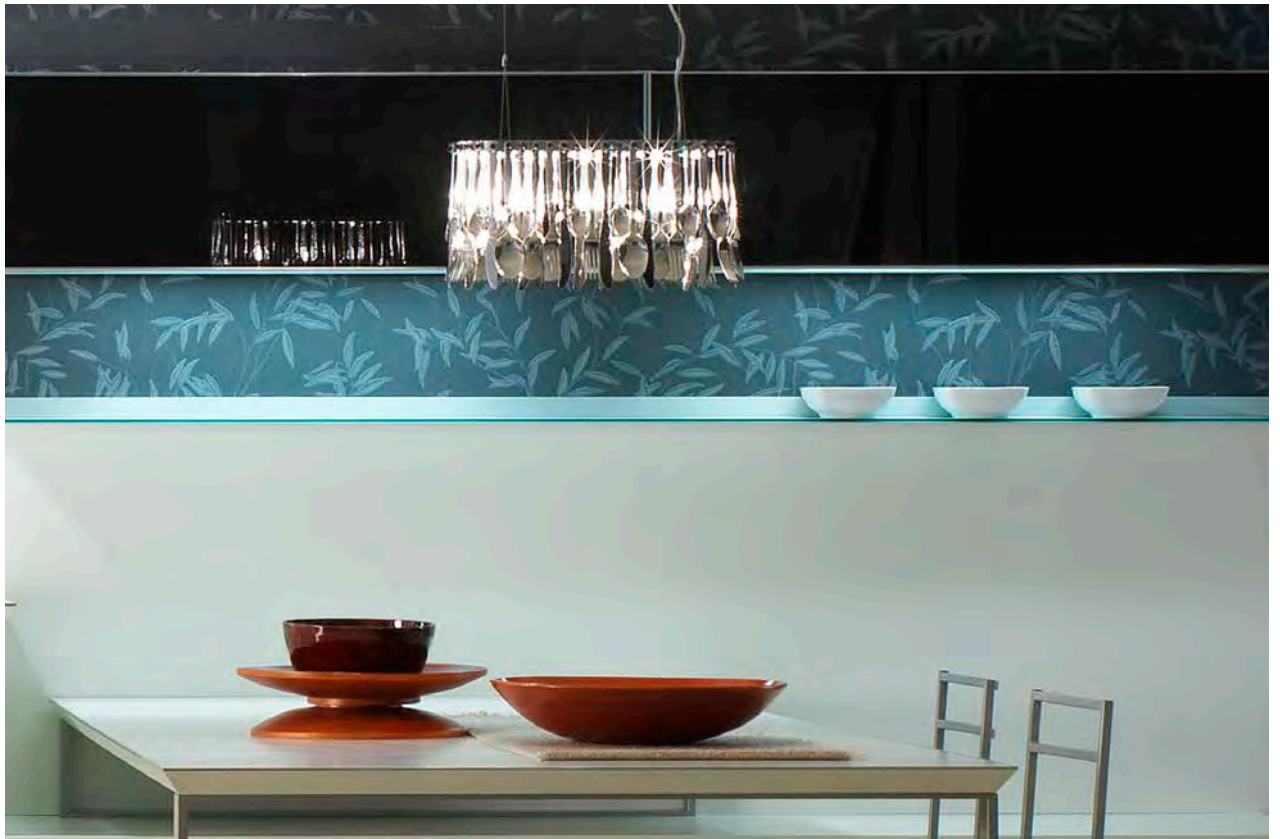

# JAZZ

—

Pamio Design





La collezione si costituisce di lampade da parete o soffitto per interno ed esterno. I diffusori sono in cristallo, parzialmente verniciato bianco e la struttura in acciaio inox. C'è la possibilità di scegliere il tipo di taglio di luce: a due tagli larghi, a due tagli stretti e a quattro stretti. La lampada, molto pulita e semplice, si adatta a tutti i tipi di ambiente creando giochi di luce molto scenografici. L'elettrificazione è a tensione di rete per lampade alogene e LED.

La colección está compuesta por apliques o plafones de interior y exterior. Los difusores son de cristal, parcialmente pintado en blanco y la estructura de acero inoxidable. Cabe la opción de elegir el tipo de corte de luz: con dos cortes anchos, dos cortes estrechos y cuatro estrechos. La lámpara, muy depurada y sencilla, encaja en todos los tipos de ambientes para crear juegos muy escenográficos de luz. La electrificación es con tensión de red para bombillas halógenas y LED.

Die Kollektion besteht aus Wand- oder Deckenlampen für Innen- und Außenbereiche. Die Diffusoren sind aus teilweise weiß lackiertem Kristallglas und die Struktur besteht aus Edelstahl. Es besteht die Möglichkeit, die Art des Lichteinschnitts zu wählen: Mit zwei breiten Einschnitten und zwei oder vier engen Einschnitten. Die sehr reine und einfache Lampe passt sich allen Umgebungsarten an und bildet sehr szenographische Lichtspiele. Die Elektrifizierung erfolgt über Netzspannung bei Halogen- und LED-Lampen.

The collection is composed of wall and ceiling lamps for both indoor and outdoor use. The diffusers are in crystal, painted partially in white, while the structure is in stainless steel. The lamp is available with either two large spotlights, two smaller spotlights or four small spotlights. The very clean, simple design of this lamp makes it suitable in any setting ensuring very spectacular lighting effects. The lamp runs on mains power and is suitable for use with halogen and LED bulbs.

La collection est constituée par des appliques/plafonniers pour intérieur. Les diffuseurs sont en cristal, partiellement verni en blanc et la structure est en acier inox. Il est possible de choisir le type de découpe de lumière: à deux découpes larges, à deux découpes étroites et à quatre découpes étroites. La lampe, très nette et simple, s'adapte à tous les espaces en créant des jeux de lumière très scénographiques. Les lampes halogènes et LED sont alimentées par la tension du réseau.

Коллекция состоит из настенных и потолочных светильников для внутреннего и наружного применения. Рассеиватели из кристалла, частично покрытые белым лаком, структура из нержавеющей стали. Есть возможность выбрать тип разреза света: на два широких, на два узких и на четыре узких разрезов. Этот простой и неприязательный светильник подходит для любого интерьера, создавая театральную игру света. Электрическая часть рассчитана на галогеновую или светодиодную лампу от сетевого напряжения.





**JAZZ**  
Pamio Design

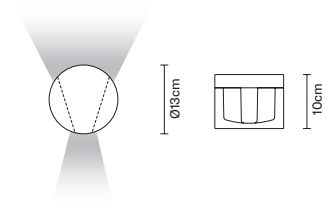

**code**      **electrification**      **technical info**      **accessories**

**D52 G01**      G9 220-240V      **EAC** IP20      NOT INCLUDED:  
**00 Transparent**      1x60W HSGS      360° ADJUSTABLE SYSTEM      - Lampadina / Bulb  
0,01 m<sup>3</sup>  
2,13 kg

2 tagli luce larghi / 2 large light beams

**D52 G02**      LED 220-240V      **EAC** IP20      INCLUDED:  
**00 Transparent**      1x8.7W-120°      360° ADJUSTABLE SYSTEM      - LED / LED  
WHITE 3000K      0,01 m<sup>3</sup>  
800lm Cri >80      2,13 kg



2 tagli luce larghi. Dimmerabile TRIAC / 2 large light beams. Dimmable TRIAC

**D52 G03**      G9 220-240V      **EAC** IP44      NOT INCLUDED:  
**00 Transparent**      1x60W HSGS      360° ADJUSTABLE SYSTEM      - Lampadina / Bulb  
0,01 m<sup>3</sup>  
2,21 kg

2 tagli luce larghi / 2 large light beams

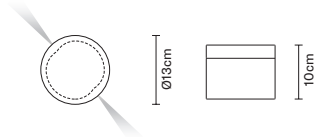

**D52 G05**      G9 220-240V      **EAC** IP20      NOT INCLUDED:  
**00 Transparent**      1x60W HSGS      360° ADJUSTABLE SYSTEM      - Lampadina / Bulb  
0,01 m<sup>3</sup>  
1,72 kg

G9 220-240V

1x48W HSGS



2 tagli luce stretti / 2 narrow light beams

**D52 G06**      LED 220-240V      **EAC** IP20      INCLUDED:  
**00 Transparent**      1x8.7W-120°      360° ADJUSTABLE SYSTEM      - LED / LED  
WHITE 3000K      0,01 m<sup>3</sup>  
800lm Cri >80      1,72 kg



2 tagli luce stretti. Dimmerabile TRIAC / 2 narrow light beams. Dimmable TRIAC

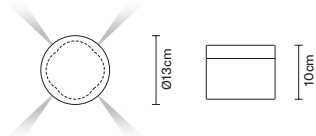

**D52 G07**      G9 220-240V      **EAC** IP20      NOT INCLUDED:  
**00 Transparent**      1x60W HSGS      360° ADJUSTABLE SYSTEM      - Lampadina / Bulb  
0,01 m<sup>3</sup>  
1,75 kg

G9 220-240V

1x48W HSGS



4 tagli luce stretti / 4 narrow light beams

**D52 G08**      LED 220-240V      **EAC** IP20      INCLUDED:  
**00 Transparent**      1x8.7W-120°      360° ADJUSTABLE SYSTEM      - LED / LED  
WHITE 3000K      0,01 m<sup>3</sup>  
800lm Cri >80      1,60 kg



4 tagli luce stretti. Dimmerabile TRIAC / 4 narrow light beams. Dimmable TRIAC

# LAMAS

Lagranja Design



## CONCEPT

---

Questa collezione si ispira alle coperture delle abitazioni tipiche mediterranee. “L’immagine della luce soffice che rimbalza e filtra tra le lame di una gelosia è il punto di partenza di questo progetto,- spiega Gabriele Schiavon, designer italiano dello studio spagnolo Lagranja Design - Tradurme però la rigida sequenza di lame parallele in una forma sensuale e dinamica si è rivelato assai complesso. Lo abbiamo fatto disegnando un modulo che ripetendosi genera un oggetto spiraliforme”. La luce che “scappa” tra le lame, disegna le forme della lampada. La sua qualità è il centro del progetto. Lamas crea una luce diretta sul tavolo o sul piano di lavoro e una luce diffusa indiretta nel resto della stanza.

This collection takes its cue from typically Mediterranean Persian blinds. “The image of soft light rebounding and filtering between the slats of a blind is the departure point of this project - explains Gabriele Schiavon, Italian designer of the Spanish firm, Lagranja Design - Translating the rigid sequence of parallel slats into a sensual and dynamic shape did in fact turn out to be harder than expected. We did it by designing a module that repeats itself to produce a spiral-shaped object”. The light which “escapes” between the slats designs the shapes of the lamp. The design focuses on quality. Lamas projects direct light onto a table or worktop and an indirect diffused light in the rest of the room.

Esta colección se inspira en las mallorquinas típicas mediterráneas. “La imagen de la luz suave que rebota y se filtra entre las láminas de una celosía es el punto de inicio de este proyecto - explica Gabriele Schiavon, diseñador italiano del estudio español Lagranja Design - Aunque traducir la secuencia rígida de láminas paralelas en una forma sensual y dinámica ha sido más complejo de lo esperado. Lo hemos conseguido diseñando un módulo que al repetirse genera un objeto con formas espirales”. La luz que “escapa” entre las láminas dibuja las formas de la lámpara. Su calidad es el centro del proyecto. Lamas crea una luz directa sobre una mesa o sobre una superficie de trabajo y una luz difusa indirecta en el resto de la habitación.

Diese Kollektion inspiriert sich an den Abdeckungen der typischen mediterranen Wohnungen. “Der Eindruck eines weichen Lichts, das zwischen den Lamellen einer Jalousie hindurch scheint und auf diese Weise in dem Raum dringt, ist der Ausgangspunkt diese Projekts”, erklärt Gabriele Schiavon, italienischer Designer des spanischen Studios Lagranja Design - “Diese strenge Sequenz der parallel gesetzten Lamellen in eine weiche und dynamische Form zu übersetzen, hat sich jedoch als komplizierter als gedacht erwiesen. Wir haben diese Aufgabe durch die Zeichnung eines Moduls gelöst, welches durch seine Wiederholung ein spiralförmiges Objekt erzeugt. Das Licht, das durch die Lamellen “hindurch schlüpft” zeichnet die Form der Lampe. Seine Qualität stellt den Schwerpunkt des Projektes dar. Lamas kriecht auf dem Tisch oder der Arbeitsplatte ein direktes Licht und ein diffuses Licht im weiteren Raum.

Cette collection s’inspire des toitures typiques des maisons méditerranéennes. “L’image de la lumière ténue qui circule et filtre entre les lames d’une jalousie est le point de départ de cet projet,- nous explique Gabriele Schiavon, designer italien du studio espagnol Lagranja Design - Par contre, parvenir à traduire la séquence rigide des lames parallèles en une forme sensuelle et dynamique s’est révélé assez complexe. Nous y sommes parvenus en dessinant un module qui, en se répétant, génère un objet en forme de spirale”. La lumière qui filtre à travers les lames, dessine les formes de la lampe. Sa qualité est le centre du projet. Lamas diffuse une lumière directe sur la table ou sur le plan de travail et répand une lumière indirecte dans le reste de la pièce.

Вдохновениеданнойколлекциनावеянокрышамитипичныхсреднихемноморских домов.“Образ мягкого света, который отражается и струится между пластинами жалюзи, вдохновил нас на создание этого проекта, - рассказывает Габриэле Скьявон, итальянский дизайнер испанского дизайнерского бюро Lagranja, - Однако преобразовать строгую последовательность параллельных пластин в чувственную и динамичную структуру оказалась сложнее, чем ожидалось. Тогда мы придумали особый модуль, который образует повторяющиеся спирали.” Свет, “ускользающий” между переборками, создает формы лампы. Его качество является центром проекта. Lamas направляет прямой свет на стол или рабочую поверхность, а отраженный рассеянный–на остальную часть комнаты.

# LAMAS

La collezione è formata da una sospensione, da una lampada da tavolo e da terra utilizzabili per interno e realizzate in policarbonato bianco con strutture in metallo verniciato a polveri. I sostegni della lampada da tavolo e lo stelo di quella da terra sono in legno Toulipier, un legno chiaro di origine nordamericana. L'elettrificazione è a tensione di rete per lampade alogene e a LED.

La colección comprende una lámpara colgante, una lámpara de sobremesa y una lámpara de pie de interior y están realizadas con policarbonato blanco y estructuras de metal pintado con polvos. Los soportes de la lámpara de sobremesa y de la de pie son de madera Toulipier, una madera clara de origen norteamericano. La electrificación es con tensión de red para bombillas halógenas y con LED.

Die Kollektion umfasst eine Hängelampe, eine Tischlampe und eine Bodenlampe für Innenbereiche. Alle Modelle bestehen aus weißem Polycarbonat mit einer Struktur aus pulverlackiertem Metall. Die Halterungen der Tischlampe und der Schaft der Bodenlampe bestehen aus Toulipier-Holz, ein helles Holz, das aus Nordamerika stammt. Die Elektrifizierung erfolgt über Netzspannung für Halogen- und LED-Lampen.

The collection consists of a hanging lamp, a table lamp and a floor lamp, all for indoor use and made of white polycarbonate with powder-coated metal structure. The supports of the table lamp and the stem of the floor lamp are in Toulipier, a light-coloured wood from North America. The lamp runs on mains power and is suitable for use with halogen and LED bulbs.

La collection est formée par une suspension, une lampe de table et un lampadaire utilisables à l'intérieur et réalisés en polycarbonate blanc avec des structures en métal avec revêtement par poudre. Les supports de la lampe de table et le pied du lampadaire sont en bois de Tulipier, un bois clair originaire d'Amérique du nord. Les lampes halogènes et LED sont alimentées par la tension du réseau.

Коллекция ламп включает подвеску, настольную лампу и торшер, для внутренних помещений, выполненные в белом поликарбонате с металлическим каркасом и порошковым покрытием. Кронштейны настольной лампы и торшера из северо-американского дерева Toulipier светлого цвета. Электрическая часть рассчитана на галогенные и светодиодные лампы от сетевого напряжения.



**LAMAS**  
Lagranja Design

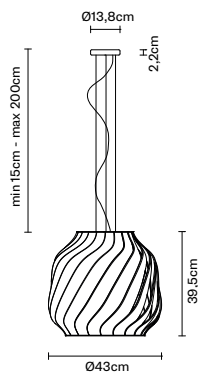

**code**

**electrification**

**technical info**

**accessories**

**F24 A01**  
01 White

E27 220-240V  
1x205W HSGST



**EAC** IP20  
0,016 m<sup>3</sup>  
0,40 kg

NOT INCLUDED:  
- Lampadina / Bulb

E27 220-240V  
1x30W FBT



**F24 A03**  
01 White

LED 220-240V  
1x17W-120°  
WHITE 3000K  
1850lm Cri >80



**EAC** IP20  
0,154 m<sup>3</sup>  
5,01 kg



INCLUDED:  
- LED / LED

Dimmerabile TRIAC / Dimmable TRIAC

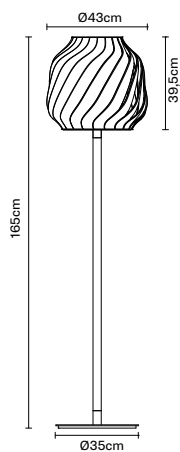

**F24 C01**  
01 White

E27 220-240V  
1x205W HSGST



**EAC** IP20  
0,016 m<sup>3</sup>  
0,40 kg

INCLUDED:  
- Dimmer elettronico / Electronic dimmer

NOT INCLUDED:  
- Lampadina / Bulb

E27 220-240V  
1x30W FBT



**F24 C03**  
01 White

LED 220-240V  
1x17W-120°  
WHITE 3000K  
1850lm Cri >80



**EAC** IP20  
0,157 m<sup>3</sup>  
16,09 kg



INCLUDED:  
- LED / LED  
- Dimmer elettronico / Electronic dimmer

Dimmerabile TRIAC / Dimmable TRIAC

# LENS

—

Lucie Koldova









## CONCEPT

---

Con la forma di una lente che concentra e fa divergere i raggi solari, Lens nasce dall'idea di catturare la luce, filtrarla, per poi rilasciarla in modo rinnovato nell'ambiente. Il decoro irregolare sulla superficie delle lenti consente alla luce di diffondersi creando un gioco di chiaroscuri sugli elementi sottostanti. L'ambiente circostante, investito da queste nuove sfumature, si fonde con il corpo luminoso creando un armonioso effetto decorativo. Le lenti intersecate assieme a gruppi di tre evocano l'incontro tra l'elemento cosmico e quello terrestre, dove la luce è la sintesi tra queste due sfere.

Inspired by a lens that concentrates and veers sunlight, Lens captures the light, filters it, and then releases it anew into the environment. The irregular lens surface décor allows the light to be propagated creating light and shadow effects on the elements below. The surrounding environment, hit by these new hues, blends together with the light source, creating a pleasant decorative effect. The 3-group lenses assemblies call to mind the cosmic and the terrestrial elements, where the light abridges these two spheres.

Con la forma de una lente, que concentra y separa los rayos solares, Lens es fruto de la idea de capturar la luz, filtrarla, para liberarla posteriormente en un modo renovado en el ambiente. La decoración irregular en la superficie de las lentes permite a la luz difundirse creando un juego de claroscuros en los elementos situados debajo. El ambiente circundante, iluminado con estos nuevos matices, se funde con el cuerpo luminoso para crear un efecto decorativo armonioso. Las lentes intersecadas en grupos de tres evocan el encuentro entre el elemento cósmico y el terrestre, donde la luz se convierte en la síntesis entre estas dos esferas.

Das Grundmotiv der Leuchte Lens mit ihrer linsenartigen Kontur, die Sonnenstrahlen aufnimmt und aussendet, ist das Einfangen und Filtern des Lichts, das dann in verwandelter Form in das Ambiente abgegeben wird. Das unregelmäßige Dekor auf der Oberfläche der Linsen ermöglicht eine Streuung des Lichts auf die darunter befindlichen Elemente in einem Spiel von Hell-Dunkel-Effekten. Der umgebende Raum wird in diese neuen Farbtönen getaucht, verschmilzt mit dem Leuchtkörper, sodass eine harmonische und dekorative Wirkung entsteht. Die sich überschneidenden Linsen bilden eine Dreiergruppe und symbolisieren die Begegnung zwischen den kosmischen Elementen und der Erde, die sich im Licht verbinden.

Avec la forme d'une lentille qui concentre et fait diverger les rayons du soleil, Lens a été créée dans le but de capturer la lumière, de la filtrer, pour ensuite la rediffuser dans la pièce. La forme irrégulière sur la surface des lentilles permet à la lumière de se propager en créant un jeu d'ombres et de lumières sur les éléments situés en-dessous. L'environnement, éclairé par ces nouvelles nuances, se fond avec le corps d'éclairage en créant un effet décoratif harmonieux. Les lentilles qui se croisent entre elles par groupes de trois, évoquent la rencontre entre l'élément cosmique et l'élément terrestre, où la lumière représente la synthèse entre ces deux sphères.

Световой источник в форме линзы, который концентрирует и рассеивает лучи света. Идея создания лампы Lens - соединить, фильтровать и потом рассеять свет необычным способом. Неровный дизайн поверхности линз позволяет рассеивать свет, отражая игру светотеней на нижестоящие предметы. Окружающая среда, в свете новых оттенков, сливается со светящимся источником, создавая единый декоративный элемент. Три линзы, пересекаемые между собой, напоминают соединение между космосом и землем, в котором свет является главным объединяющим элементом.

# LENS

La collezione Lens si compone di due tipologie di sospensioni. La versione singola, composta da un proiettore a LED che riflette la luce su un'unica lente metallica; e la versione multipla, composta da un proiettore con tre LED che riflette la luce su tre lenti metalliche intersecate tra loro. I dischi metallici prendono le coloriture brunate dell'ottone, del rame e del ferro nero grazie ad un processo artigianale che rende ogni lente unica nella sua finitura.

La colección Lens está compuesta por dos tipologías de lámparas colgantes. La versión individual, compuesta por un proyector con LED, que refleja la luz sobre una única lente metálica y la versión múltiple, compuesta por un proyector con tres LEDs, que refleja la luz sobre tres lentes metálicas intersecadas entre sí. Los discos metálicos presentan los coloridos bruñidos del latón, del cobre y del hierro negro mediante un proceso artesano para que cada lente resulte única en su acabado.

Die Kollektion Lens bietet zwei Typologien von Hängelampen. Die Ausführung mit LED-Strahler reflektiert das Licht auf eine einzige Metall-Linse; die Mehrfachversion lenkt das Licht auf drei Linsen aus Metall, die sich überschneiden. Die Metallscheiben haben dank eines handwerklichen Verfahrens, das jeder Linse ein einzigartiges Finish schenkt, die brünierte Tönung von Messing, Kupfer und von schwarzem Eisen.

The Lens collection comprises two types of hanging lamps. The single version, comprising a LED spotlight which reflects the light on one metal lens, and the multiple version, comprising a 3-LED spotlight which reflects the light on three intertwined metal lenses. The metal discs are brass, copper and black iron coloured, through an artisanal process which makes each lens finish unique.

La collection Lens est composée par deux typologies de suspensions. La version simple, composée par un projecteur à LED qui reflète la lumière sur une seule lentille métallique et la version multiple, composée par un projecteur avec trois LED qui reflète la lumière sur trois lentilles métalliques qui se croisent entre elles. Les disques métalliques arborent les teintes brunes du laiton, du cuivre et du fer noir, grâce à un procédé artisanal qui confère une finition unique à chaque lentille.

Коллекция Lens состоит из двух типов подвесок. Версия с одной подвеской включает светодиод, который рассеивает свет на одну металлическую линзу; версия с тремя подвесками состоит из прожекторов с тремя светодиодами, которые рассеивают свет на три металлические линзы, пересекаемые между собой. Металлические диски окрашиваются вручную с использованием специальной обработки, которая придает дискам коричневатый оттенок латуни, меди и черного железа.



**LENS**

Lucie Koldova

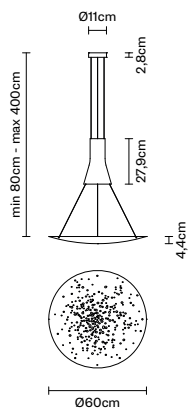

**F46 A01**

14 *Satin-finish*  
burnished  
56 *Rust*  
76 *Bronze*

LED 220-240V  
1x26W-35°  
WHITE 3000K  
2400lm Cri 92



**EAC** IP40

INCLUDED:

- LED / LED
- Alimentatore elettronico dimmerabile / Dimmable electronic driver

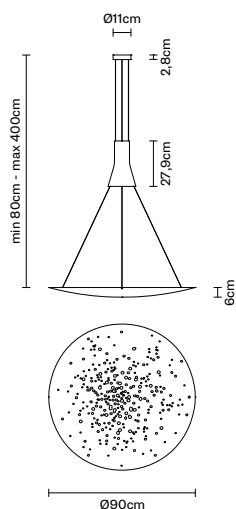

**F46 A03**

14 *Satin-finish*  
burnished  
56 *Rust*  
76 *Bronze*

LED 220-240V  
1x26W-35°  
WHITE 3000K  
2400lm Cri 92



**EAC** IP40

INCLUDED:

- LED / LED
- Alimentatore elettronico dimmerabile / Dimmable electronic driver



**LENS**

Lucie Koldova

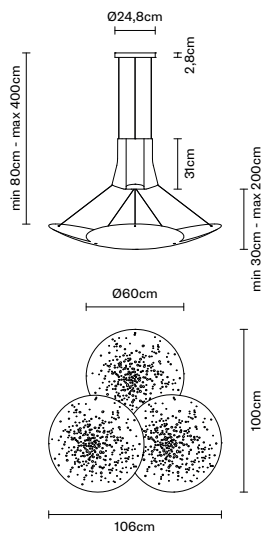

**NEW!** **F46 A05**  
**14** *Satin-finish*  
**14** *burnished*  
**56** *Rust*  
**76** *Bronze*  
**99** *Multicolour*

LED 220-240V  
 3x26W-35°  
 WHITE 3000K  
 7200lm Cri 92



**EAC** IP40

INCLUDED:  
 - LED / LED  
 - Alimentatore elettronico dimmerabile /  
*Dimmable electronic driver*

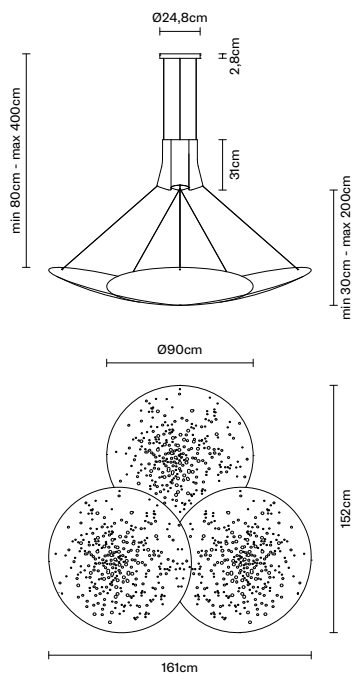

**NEW!** **F46 A07**  
**14** *Satin-finish*  
**14** *burnished*  
**56** *Rust*  
**76** *Bronze*  
**99** *Multicolour*

LED 220-240V  
 3x26W-35°  
 WHITE 3000K  
 7200lm Cri 92



**EAC** IP40

INCLUDED:  
 - LED / LED  
 - Alimentatore elettronico dimmerabile /  
*Dimmable electronic driver*

# LOOP

—

Constance Guisset

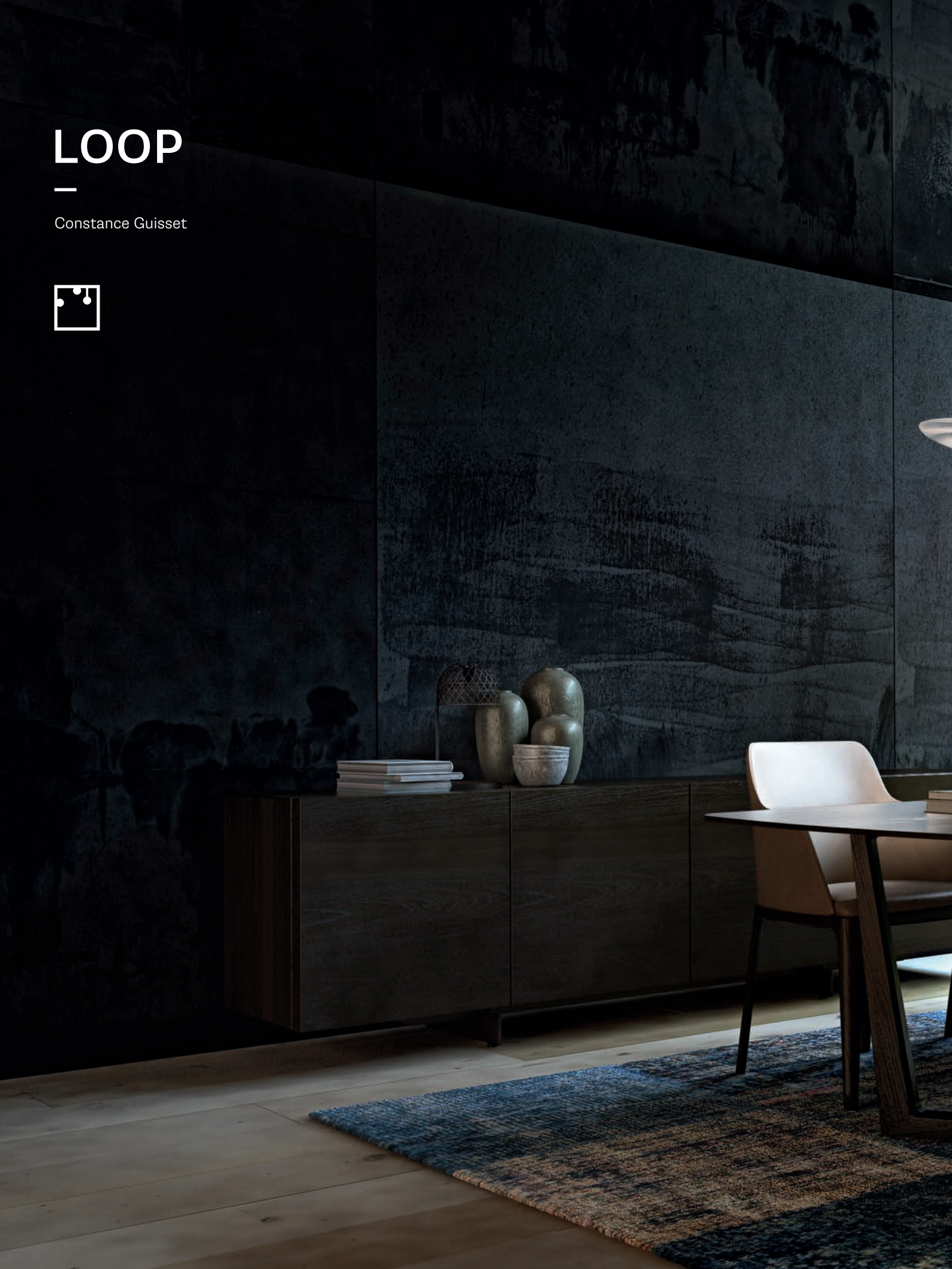







## CONCEPT

---

Loop è una lampada danzante, che si libra nell'aria con eleganza e grazia esercitando un dolce fascino attraverso il movimento delle sue forme. Il vetro fine e delicato porta leggerezza a questo strano volare, Loop galleggia pacificamente nell'infinito, oscilla dolcemente come fosse nello spazio aperto, come il lembo di una gonna mosso dal vento o l'agile trasporto di una medusa nel mare. Questa collezione di lampade è adatta a più ambienti e si presta a impreziosire al meglio gli spazi sia classici che moderni caratterizzandoli con il suo gusto raffinato ma particolare.

Loop is a “dancing” lamp that hovers in the air with grace and elegance, exerting a charm through the movements of its forms. The fine and delicate glass makes it seem lightweight in this strange flight. Loop floats peacefully in infinity, and swings as though in space, like the pleats of a skirt moving in the wind or the agile transportation of a jellyfish. This collection of lamps is suitable for most environments and can enhance classical or modern style rooms, giving a refined but unique look.

Loop es una lámpara danzante, que planea en el aire con elegancia y gracia para ejercer una fascinación delicada mediante el movimiento de sus formas. El vidrio fino y delicado regala ligereza a este vuelo extraño, Loop flota pacíficamente en el infinito, oscila suavemente como si estuviese en el espacio abierto, como el bajo de una falda movido por el viento o el transporte ágil de una medusa en el mar. Esta colección de lámparas es idónea para varios ambientes y se presta para embellecer de la mejor forma los espacios clásicos y los modernos al caracterizarlos con su gusto refinado pero especial.

Loop ist eine tanzende Lampe, die sich in der Luft elegant, anmutig und frei bewegt und einen sanften Charme dank der Bewegung ihrer Formen ausdrückt. Das feine und zarte Glas vermittelt diesem außergewöhnlichen Flug Leichtigkeit. Loop schwimmt friedlich im Unendlichen, schwenkt weich wie in einem freien Raum, wie der Saum eines vom Wind bewegten Rocks oder eine flinke Meduse im Meer. Diese Lampenkollektion ist für mehrere Umgebungen geeignet und bietet sich an, um klassische und moderne Räume aufzuwerten und einen eleganten und besonderen Stil zu verleihen.

Loop est une lampe dansante, flottant dans l'air avec élégance et grâce et en exerçant un charme doux à travers le mouvement de ses formes. La finesse de son verre est délicate et donne de la légèreté à cet étrange façon de voler. Loop flotte pacifique dans l'infini et oscille dans la douceur comme si elle se trouvait dans un espace ouvert, comme le bord d'une jupe s'envolant au vent ou comme le mouvement agile d'une méduse dans la mer. Cette collection de lampes est adaptée à tout type d'environnement et décore à la perfection les espaces classiques et modernes en leur donnant de la personnalité grâce à son raffinement particulier.

Линейка Loop представляет своего рода «танцующую» лампу, парящую в воздухе с элегантностью и изяществом, создающую мягкое очарование через движение своих форм. Тонкое и хрупкое стекло делает странный «полет» светильника в бесконечности легким, похожим на «плавание» в открытом космосе, или подобно развевающемуся шлейфу платья, тому, как несет вдаль медузу морская синева. Эта коллекция светильников подойдет для большинства помещений, украшая пространство, как классического стиля, так и современного, характеризуя его изысканностью и уникальностью.

# LOOP

---

La collezione Loop comprende una sospensione e una lampada da parete e da soffitto. Il corpo illuminante è in vetro soffiato parzialmente sabbato sul fondo, da installare in ambienti interni. La sospensione è disponibile con struttura in finitura verniciata nera opaca, ramata lucido e ottonata brunita mentre la lampada da parete e soffitto è disponibile con struttura in finitura verniciata bianca opaca. L'elettrificazione è a tensione di rete per lampade alogene e LED.

La colección Loop comprende una lámpara colgante, un aplique y un plafón. El cuerpo de iluminación es de vidrio soplado, parcialmente arenado en el fondo, para instalar en ambientes internos. La lámpara colgante presenta una estructura con acabado pintado de color negro mate, pintado de color blanco mate, cobrizo brillante y latoneado bruñido mientras que el aplique y el plafón presentan una estructura con acabado pintado de color blanco mate. La electrificación es con tensión de red para bombillas halógenas y Led.

Die Kollektion Loop schließt eine Hängelampe, eine Wandlampe sowie eine Deckenlampe ein. Der Leuchtkörper besteht aus am Boden teilweise sandgestrahltem, geblasenem Glas - für Innenbereiche geeignet. Die Hängelampe ist mit einer mattschwarz, mattweiß lackierten und kupferpolierten und messingbrünierten Struktur erhältlich, während die Decken- und Wandlampen mit einer mattweiß lackierten Struktur angeboten werden. Die Elektrifizierung erfolgt über Netzspannung mit Halogen- und LED-Lampen.

The Loop collection is made up of a pendant lamp, a wall lamp and a ceiling lamp. The shade is in blown glass, partly blown on the base, and is made for indoor use. The pendant lamp is available in an black opaque finish, shiny copper or burnished brass, while the wall and ceiling lamps are available in an opaque white finish. The energy voltage makes these lamps suitable with halogen lamps and LED.

La collection Loop se compose d'une lampe suspension, d'une applique et d'un plafonnier. Le corps des lampes est en verre soufflé et partiellement sablé sur le fond. Les lampes doivent être installées à l'intérieur. La lampe suspension est proposée avec une structure finition peinte en noir opaque, cuivre brillant ou laiton bruni alors que la lampe murale et le plafonnier sont disponibles avec une structure peinte en blanc opaque. L'électrification est à tension de réseau pour des ampoules halogènes et LED.

Коллекция Loop для внутреннего освещения включает в себя подвесной светильник, бра и люстру. Плафон выполнен из выдувного стекла, который частично имеет пескоструйную обработку внутри. Структура подвесного светильника может иметь матовую черную, матовую белую, глянцевую медную или вороненую латунную отделку, в то время, как структура бра и люстры отделана матовой белой краской. Цоколь предназначен для галогенных ламп и светодиодов (LED).



**LOOP**

Constance Guisset

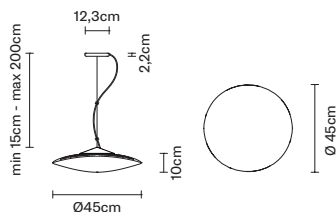

<i>code</i>	<i>electrification</i>	<i>technical info</i>	<i>accessories</i>
<b>F35 A01</b> 00 Transparent	LED 220-240V 1x17W-120° WHITE 3000K 1850lm Cri >80 ⊕	<b>EAC</b> IP20 0,07 m³ 4,86 kg LED	INCLUDED: - LED / LED - Kit per decentramento / <i>Off-center cable fastener</i>
Struttura verniciata nera opaca. Dimmerabile TRIAC / <i>Black painted matt structure. Dimmable TRIAC</i>			
<b>F35 A03</b> 00 Transparent	R7s (78 mm) 220-240V 1x120W HDG ⊕	<b>EAC</b> IP20 0,07 m³ 4,44 kg	INCLUDED: - Kit per decentramento / <i>Off-center cable fastener</i>  NOT INCLUDED: - Lampadina / <i>Bulb</i>
Struttura verniciata nera opaca / <i>Black painted matt structure</i>			
<b>F35 A09</b> 00 Transparent	LED 220-240V 1x17W-120° WHITE 3000K 1850lm Cri >80 ⊕	<b>EAC</b> IP20 0,07 m³ 4,86 kg LED	INCLUDED: - LED / LED - Kit per decentramento / <i>Off-center cable fastener</i>
Struttura ramata lucida. Dimmerabile TRIAC / <i>Copper-plated structure. Dimmable TRIAC</i>			
<b>F35 A11</b> 00 Transparent	R7s (78 mm) 220-240V 1x120W HDG ⊕	<b>EAC</b> IP20 0,07 m³ 4,44 kg	INCLUDED: - Kit per decentramento / <i>Off-center cable fastener</i>  NOT INCLUDED: - Lampadina / <i>Bulb</i>
Struttura ramata lucida / <i>Copper-plated structure</i>			
<b>F35 A13</b> 00 Transparent	LED 220-240V 1x17W-120° WHITE 3000K 1850lm Cri >80 ⊕	<b>EAC</b> IP20 0,07 m³ 4,86 kg LED	INCLUDED: - LED / LED - Kit per decentramento / <i>Off-center cable fastener</i>
Struttura ottonata brunita. Dimmerabile TRIAC / <i>Burnished brass structure. Dimmable TRIAC</i>			
<b>F35 A15</b> 00 Transparent	R7s (78 mm) 220-240V 1x120W HDG ⊕	<b>EAC</b> IP20 0,07 m³ 4,44 kg	INCLUDED: - Kit per decentramento / <i>Off-center cable fastener</i>  NOT INCLUDED: - Lampadina / <i>Bulb</i>
Struttura ottonata brunita / <i>Burnished brass structure</i>			

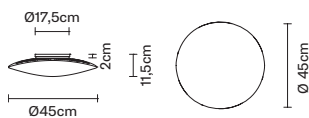

<b>F35 G01</b> 00 Transparent	LED 220-240V 1x17W-120° WHITE 3000K 1850lm Cri >80 ⊕	<b>EAC</b> IP40 0,07 m³ 4,64 kg LED	INCLUDED: - LED / LED
Struttura verniciata bianca opaca. Dimmerabile TRIAC / <i>White painted matt structure. Dimmable TRIAC</i>			
<b>F35 G03</b> 00 Transparent	R7s (78 mm) 220-240V 1x120W HDG ⊕	<b>EAC</b> IP40 0,07 m³ 4,32 kg	NOT INCLUDED: - Lampadina / <i>Bulb</i>
Struttura verniciata bianca opaca / <i>Opaque white painted structure</i>			

# LUMI

—

A. Saggia & V. Sommella / D&G Studio









# CONCEPT

---

Ai giovani designer Saggia&Sommella è stato dato un preciso obiettivo: andare oltre la sfera luminosa, sono così nati nuovi diffusori di diverse forme. Con il nome Lumi si è voluto dare una doppia valenza: la prima più diretta, poiché legata al mondo dell'illuminazione, che vuole raccogliere sotto un unico nome una tipologia precisa di lampade, con un termine però raffinato e arcaico; la seconda parte invece dalla traduzione del termine "neve" in finlandese, appunto "lumi", sottolineando ancora come la principale caratteristica di queste lampade sia il diffusore bianco opale, dalle forme morbide e delicate, proprio come la neve.

The young designers Saggia&Sommella were given the precise goal of going beyond the typical round shape of light bulbs, which led to the creation of new diffusers in a variety of shapes. The name Lumi is important for two reasons: the first is more direct, being tied to the lighting world, which intends collecting under a single name a precise type of lamp, but with a refined and archaic term; the second has to do with the translation of the word "snow" in Finnish, i.e., "lumi", thereby again underscoring how the main feature of these lamps is the opal white diffuser, with soft and delicate shapes, just like snow.

A los jóvenes diseñadores Saggia&Sommella se les ha planteado un objetivo concreto: superar la esfera luminosa y así han nacido nuevos difusores con formas distintas. Con el nombre Lumi se ha querido dar un valor doble: el primero más directo, al estar ligado al mundo de la iluminación, que quiere recoger con un único nombre un tipo preciso de lámparas, con un término más refinado y arcaico; el segundo, sin embargo, parte de la traducción del término "nieve" en finlandés, precisamente "lumi", por lo que se destaca de nuevo que la característica principal de esta lámpara es el difusor blanco opalino, con formas suaves y delicadas, como la nieve.

Den jungen Designern Saggia&Sommella wurde ein präzises Ziel gegeben: Über die Leuchtkugel hinausgehen. So entstanden neue Diffusoren in verschiedenen Formen. Mit dem Namen Lumi wollte man einen doppelten Wert verleihen: Der erste direkt mit der Beleuchtungswelt verbundene, der unter einem Namen eine präzise Lampentypologie zusammenfassen will, mit einem eleganten und archaischen Begriff; der zweite stammt dagegen aus der Übersetzung des Worts „Schnee“ auf Finnisch, also „lumi“, womit die Haupteigenschaft dieser Lampe unterstrichen wird, d.h. ihr mattweißer Diffusor mit weichen und zarten Formen, wie Schnee.

Les jeunes designers Saggia&Sommella n'avaient qu'un seul objectif: aller au-delà de la boule lumineuse, c'est ainsi que de nouveaux diffuseurs de différentes formes ont été créés. Avec le nom Lumi, on a voulu donner une double signification: la première, plus directe, car elle est liée au monde de l'éclairage qui veut regrouper une typologie précise de lampes avec un seul nom, mais avec un nom plus raffiné et archaïque; par contre, la seconde, prend son origine dans la traduction du mot "neige" en finlandais, "lumi", en soulignant encore que la caractéristique principale de ces lampes est le diffuseur blanc opale, avec des formes légères et délicates, comme la neige.

Молодым дизайнерам из студии Saggia&Sommella была поставлена четкая задача: выйти за рамки привычной лампы-сферы: так были созданы новые рассеиватели различных форм. Название Lumi имеет двойное значение: первое напрямую относится к освещению, и включает в себя определенный тип ламп, которым дизайнеры решили дать это изящное и старинное имя; второе значение слова "lumi" в переводе с финского означает "снег", оно подчеркивает основную характеристику этих ламп, а именно рассеиватель белого опалового цвета нежной, снежной формы.

# LUMI

La collezione è costituita da sospensioni, lampade da tavolo, terra, parete e soffitto di molteplici forme e dimensioni, da utilizzare per ambienti interni. Il gruppo Mycena dà inoltre la possibilità di creare composizioni a più vetri utilizzando l'accessorio apposito, mentre Mochi presenta anche una serie di sospensioni a "cascata". Tutti i diffusori sono in vetro soffiato bianco satinato, le strutture portanti sono in metallo verniciato bianco o poliestere rinforzato con fibra di vetro. L'elettrificazione è a tensione di rete per lampade alogene, fluorescenti e LED.

La colección está compuesta por lámparas colgantes, lámparas de sobremesa, de pie, apliques y plafones de formas y medidas múltiples, para usar en ambientes internos. El grupo Mycena permite crear también composiciones de varios elementos mediante el accesorio correspondiente mientras que Mochi presenta asimismo una serie de lámparas colgantes en "cascada". Todos los difusores son de vidrio soplado blanco satinado y las estructuras de soporte son de metal pintado de color blanco o poliéster reforzado con fibra de vidrio. La electrificación es con tensión de red para bombillas halógenas, fluorescentes y LED.

Die Kollektion besteht aus Hängelampen, Tisch-, Boden-, Decken- und Wandlampen in zahlreichen Formen und Abmessungen für innen und außen. Die Gruppe Mycena verleiht außerdem die Möglichkeit, Zusammensetzungen mit mehreren Gläsern über das hierfür vorgesehene Zubehörteil zu bilden, während Mochi auch verschiedene fallende Hängelampen einschließt. Alle Diffusoren sind aus satiniertem, weißem und geblasenem Glas, die Trägerstrukturen sind aus weiß lackiertem Metall oder mit Glasfaser verstärktem Polyester. Die Elektrifizierung erfolgt über Netzspannung bei Halogen-, Fluoreszenz- und LED-Lampen.

The collection is made up of hanging, table, floor, wall and ceiling lamps in many different shapes and sizes, for indoor use. In addition, the Mycena series makes it possible to create layouts with different glass panels using the special accessory, while the Mochi series also has a range of "falling" hanging lamps. All the diffusers are in white satin-finish blown glass, while the load-bearing structures are in white painted metal or polyester, reinforced with glass fibre. The lamp runs on mains power and is suitable for use with halogen, fluorescent and LED bulbs.

La collection est constituée par des suspensions, des lampes de table, des lampadaires, des appliques murales et des plafonniers, de plusieurs formes et dimensions, à utiliser à l'intérieur. Le groupe Mycena donne également la possibilité de créer des compositions avec plusieurs verres en utilisant l'accessoire approprié, alors que Mochi présente aussi une série de suspensions en "cascade". Tous les diffuseurs sont en verre soufflé blanc satiné, les structures portantes sont en métal verni blanc ou en polyester renforcé avec de la fibre de verre. Les lampes halogène, fluorescentes et LED sont alimentées par la tension du réseau.

Коллекция состоит из подвесных, настольных, настенных, напольных и потолочных ламп различных форм и размеров, для внутренних помещений. Группа ламп Мусена дает возможность создавать различные композиции из стекол, используя специальную фурнитуру; группа ламп Мочи состоит из серий «каскадных» подвесок. Все рассеиватели выполнены из белого сатинированного выдувного стекла, несущая структура из металла с белым лаковым покрытием или из полиэстера, армированного стекловолокном. Электрическая часть рассчитана на галогеновые, люминесцентные и светодиодные лампы от сетевого напряжения.

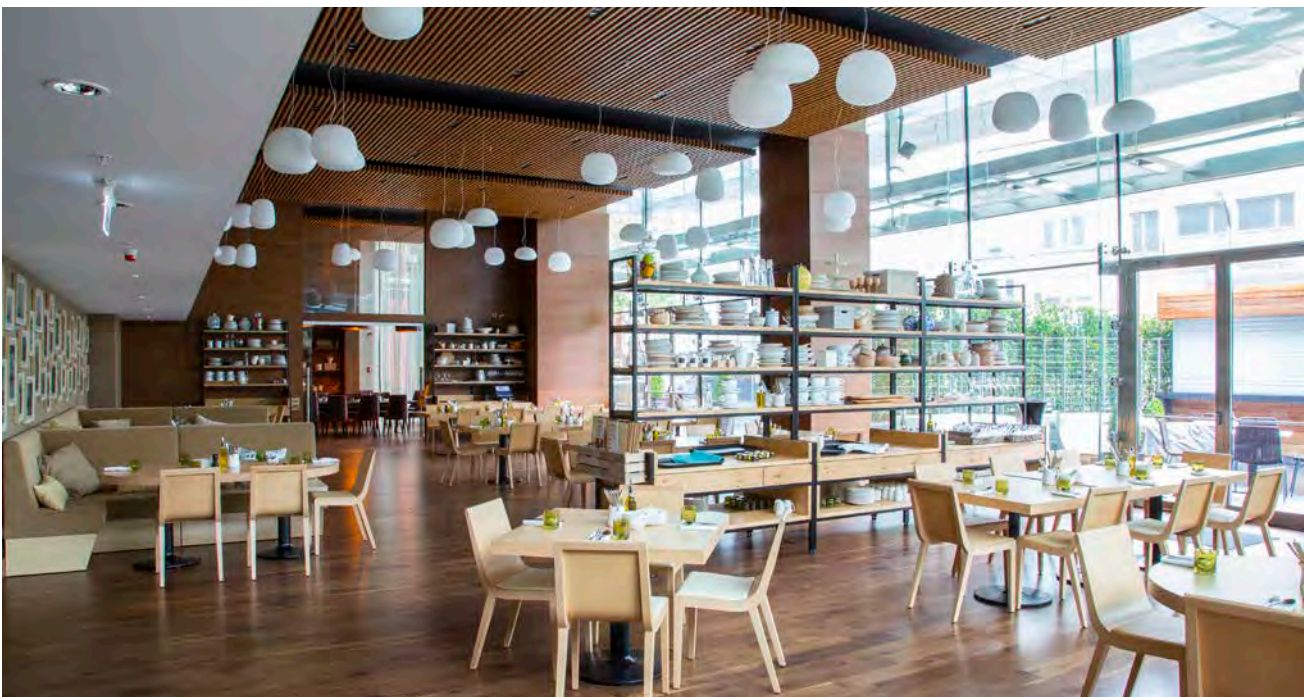

**LUMI**

A. Saggia & V. Sommella / D&G Studio

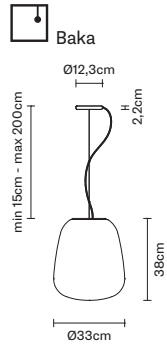

**code**

**electrification**

**technical info**

**accessories**

**F07 A15**  
01 White

E27 220-240V  
1x150W HSGST



**EAC** IP20  
0,133 m<sup>3</sup>  
4,58 kg

INCLUDED:  
- Kit per decentramento / *Off-center cable fastener*

NOT INCLUDED:  
- Lampadina / *Bulb*

E27 220-240V  
1x30W FBT



**F07 A35**  
01 White

LED 220-240V  
1x17W-120°  
WHITE 3000K  
1850lm CRI >80



**EAC** IP20  
0,133 m<sup>3</sup>  
4,56 kg

INCLUDED:  
- LED / *LED*  
- Kit per decentramento / *Off-center cable fastener*

Dimmerabile TRIAC / *Dimmable TRIAC*

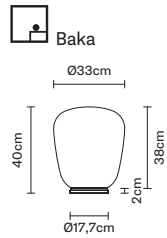

**F07 B21**  
01 White

E27 220-240V  
1x150W HSGST



**EAC** IP40  
0,133 m<sup>3</sup>  
4,58 kg

NOT INCLUDED:  
- Lampadina / *Bulb*

E27 220-240V  
1x30W FBT



**F07 B41**  
01 White

LED 220-240V  
1x17W-120°  
WHITE 3000K  
1850lm CRI >80



**EAC** IP40  
0,133 m<sup>3</sup>  
4,07 kg

INCLUDED:  
- LED / *LED*



**LUMI**

A. Saggia & V. Sommella / D&G Studio

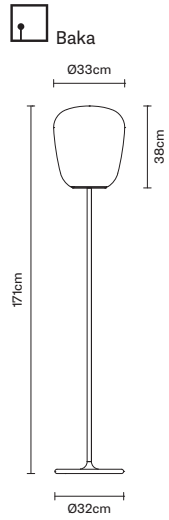

**code**

**electrification**

**technical info**

**accessories**

**F07 C07**  
01 White

E27 220-240V  
1x150W HSGST



**EAC** IP40  
0,271 m<sup>3</sup>  
12,67 kg

NOT INCLUDED:  
- Lampadina / Bulb

E27 220-240V  
1x30W FBT

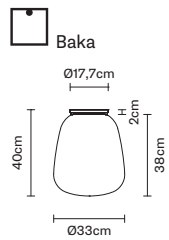

**F07 E07**  
01 White

E27 220-240V  
1x150W HSGST



**EAC** IP40  
0,133 m<sup>3</sup>  
4,63 kg

NOT INCLUDED:  
- Lampadina / Bulb

E27 220-240V  
1x30W FBT



**F07 E11**  
01 White

LED 220-240V  
1x17W-120°  
WHITE 3000K  
1850lm CRI >80



**EAC** IP40  
0,133 m<sup>3</sup>  
4,74 kg

INCLUDED:  
- LED / LED



Dimmerabile TRIAC / Dimmable TRIAC



**LUMI**

A. Saggia & V. Sommella / D&G Studio

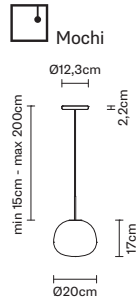

**code**

**electrification**

**technical info**

**accessories**

**F07 A05**  
01 White

G9 220-240V  
1x60W HSGS



**EAC** IP40  
0,022 m<sup>3</sup>  
1,16 kg

INCLUDED:  
- Kit per decentramento / *Off-center cable fastener*

NOT INCLUDED:  
- Lampadina / *Bulb*

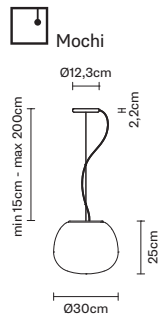

**F07 A07**  
01 White

E27 220-240V  
1x150W HSGST



**EAC** IP20  
0,071 m<sup>3</sup>  
3,09 kg

INCLUDED:  
- Kit per decentramento / *Off-center cable fastener*

NOT INCLUDED:  
- Lampadina / *Bulb*

E27 220-240V  
1x30W FBT



**F07 A41**  
01 White

LED 220-240V  
1x17W-120°  
WHITE 3000K  
1850lm Cri >80



**EAC** IP20  
0,071 m<sup>3</sup>  
3,82 kg

INCLUDED:  
- LED / *LED*  
- Kit per decentramento / *Off-center cable fastener*

Dimmerabile TRIAC / *Dimmable TRIAC*





**LUMI**

A. Saggia & V. Sommella / D&G Studio

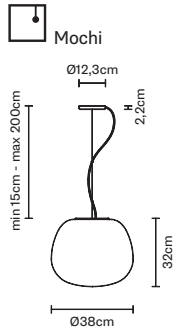

**code**

**electrification**

**technical info**

**accessories**

**F07 A01**  
01 White

E27 220-240V  
1x150W HSGST



**EAC** IP20  
0,106 m<sup>3</sup>  
4,57 kg

INCLUDED:  
- Kit per decentramento / *Off-center cable fastener*

NOT INCLUDED:  
- Lampadina / *Bulb*

E27 220-240V  
1x30W FBT



**F07 A37**  
01 White

LED 220-240V  
1x17W-120°  
WHITE 3000K  
1850lm Cri >80



**EAC** IP20  
0,106 m<sup>3</sup>  
4,31 kg

INCLUDED:  
- LED / *LED*  
- Kit per decentramento / *Off-center cable fastener*



Dimmerabile TRIAC / *Dimmable TRIAC*

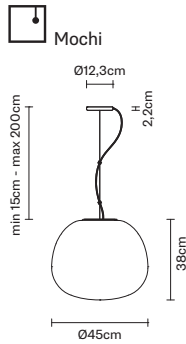

**F07 A03**  
01 White

E27 220-240V  
1x205W HSGST



**EAC** IP20  
0,122 m<sup>3</sup>  
5,94 kg

INCLUDED:  
- Kit per decentramento / *Off-center cable fastener*

NOT INCLUDED:  
- Lampadina / *Bulb*

E27 220-240V  
1x30W FBT



**F07 A39**  
01 White

LED 220-240V  
1x17W-120°  
WHITE 3000K  
1850lm Cri >80



**EAC** IP20  
0,122 m<sup>3</sup>  
5,39 kg

INCLUDED:  
- LED / *LED*  
- Kit per decentramento / *Off-center cable fastener*



Dimmerabile TRIAC / *Dimmable TRIAC*



**LUMI**

A. Saggia & V. Sommella / D&G Studio

**code**

**electrification**

**technical info**

**accessories**

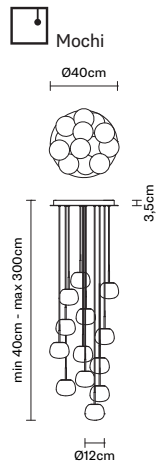

**F07 A29**  
01 White

G9 220-240V  
13x20W HSGS  

**EAC** IP40  
0,066 m<sup>3</sup>  
9,27 kg

INCLUDED:  
- Lampadina / Bulb

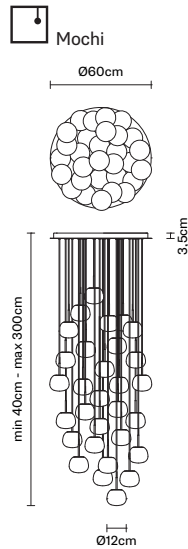

**F07 A31**  
01 White

G9 220-240V  
30x20W HSGS  

**EAC** IP40  
0,028 m<sup>3</sup>  
16,51 kg

INCLUDED:  
- Lampadina / Bulb

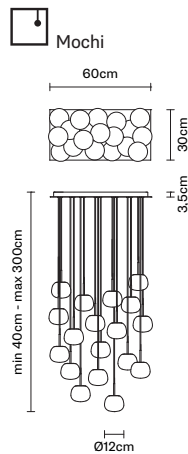

**F07 A33**  
01 White

G9 220-240V  
18x20W HSGS  

**EAC** IP40  
0,096 m<sup>3</sup>  
12,35 kg

INCLUDED:  
- Lampadina / Bulb



**LUMI**

A. Saggia & V. Sommella / D&G Studio

**code**

**electrification**

**technical info**

**accessories**



Mochi

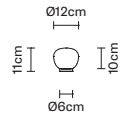

**F07 B01**  
01 White

G9 220-240V  
1x20W HSGS



**EAC** **IP40**  
0,005 m<sup>3</sup>  
0,53 kg

NOT INCLUDED:  
- Lampadina / Bulb



Mochi

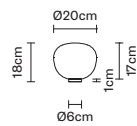

**F07 B07**  
01 White

G9 220-240V  
1x48W HSGS



**EAC** **IP40**  
0,022 m<sup>3</sup>  
0,73 kg

NOT INCLUDED:  
- Lampadina / Bulb



Mochi

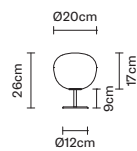

**F07 B03**  
01 White

G9 220-240V  
1x48W HSGS



**EAC** **IP40**  
0,022 m<sup>3</sup>  
1,31 kg

NOT INCLUDED:  
- Lampadina / Bulb



Mochi

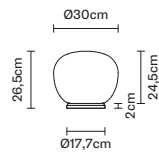

**F07 B09**  
01 White

E27 220-240V  
1x150W HSGST



**EAC** **IP40**  
0,071 m<sup>3</sup>  
2,73 kg

NOT INCLUDED:  
- Lampadina / Bulb

E27 220-240V  
1x30W FBT



**F07 B45**  
01 White

LED 220-240V  
1x17W-120°  
WHITE 3000K  
1850lm CRI >80



**EAC** **IP40**  
0,071 m<sup>3</sup>  
2,82 kg

INCLUDED:  
- LED / LED



Mochi

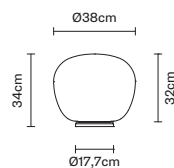

**F07 B05**  
01 White

E27 220-240V  
1x150W HSGST



**EAC** **IP40**  
0,106 m<sup>3</sup>  
4,12 kg

NOT INCLUDED:  
- Lampadina / Bulb

E27 220-240V  
1x30W FBT



**F07 B43**  
01 White

LED 220-240V  
1x17W-120°  
WHITE 3000K  
1850lm CRI >80



**EAC** **IP40**  
0,106 m<sup>3</sup>  
4,44 kg

INCLUDED:  
- LED / LED





**LUMI**

A. Saggia & V. Sommella / D&G Studio



Mochi

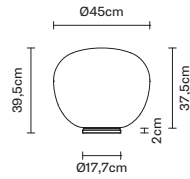

**code**

**electrification**

**technical info**

**accessories**

**F07 B11**  
01 White

E27 220-240V  
1x150W HSGST



**EAC** IP40  
0,122 m<sup>3</sup>  
4,93 kg

NOT INCLUDED:  
- Lampadina / Bulb

E27 220-240V  
1x30W FBT



**F07 B47**  
01 White

LED 220-240V  
1x17W-120°  
WHITE 3000K  
1850lm Cri >80



**EAC** IP40  
0,122 m<sup>3</sup>  
6,25 kg



INCLUDED:  
- LED / LED



Mochi

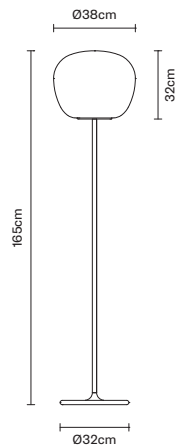

**F07 C01**  
01 White

E27 220-240V  
1x150W HSGST



**EAC** IP40  
0,26 m<sup>3</sup>  
12,30 kg

NOT INCLUDED:  
- Lampadina / Bulb

E27 220-240V  
1x30W FBT



Mochi

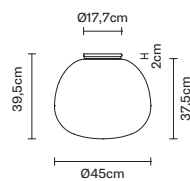

**F07 E05**  
01 White

E27 220-240V  
1x205W HSGST



**EAC** IP40  
0,122 m<sup>3</sup>  
5,01 kg

NOT INCLUDED:  
- Lampadina / Bulb

E27 220-240V  
1x30W FBT



**F07 E13**  
01 White

LED 220-240V  
1x17W-120°  
WHITE 3000K  
1850lm Cri >80



**EAC** IP40  
0,122 m<sup>3</sup>  
6,10 kg



INCLUDED:  
- LED / LED

Dimmerabile TRIAC / Dimmable TRIAC





**LUMI**

A. Saggia & V. Sommella / D&G Studio

**code**

**electrification**

**technical info**

**accessories**

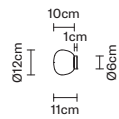

**F07 G01**  
01 White

G9 220-240V  
1x20W HSGS



**EAC** IP44  
0,005 m<sup>3</sup>  
0,50 kg

NOT INCLUDED:  
- Lampadina / Bulb

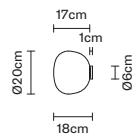

**F07 G03**  
01 White

G9 220-240V  
1x60W HSGS



**EAC** IP44  
0,022 m<sup>3</sup>  
0,90 kg

NOT INCLUDED:  
- Lampadina / Bulb

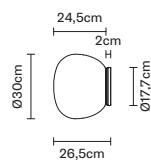

**F07 G05**  
01 White

E27 220-240V  
1x150W HSGST



**EAC** IP40  
0,071 m<sup>3</sup>  
3,08 kg

NOT INCLUDED:  
- Lampadina / Bulb

E27 220-240V  
1x30W FBT



**F07 G35**  
01 White

LED 220-240V  
1x17W-120°  
WHITE 3000K  
1850lm Cri >80



**EAC** IP40  
0,071 m<sup>3</sup>  
3,60 kg



INCLUDED:  
- LED / LED

Dimmerabile TRIAC / Dimmable TRIAC

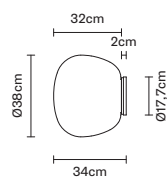

**F07 G07**  
01 White

E27 220-240V  
1x150W HSGST



**EAC** IP40  
0,106 m<sup>3</sup>  
4,20 kg

NOT INCLUDED:  
- Lampadina / Bulb

E27 220-240V  
1x30W FBT



**F07 G37**  
01 White

LED 220-240V  
1x17W-120°  
WHITE 3000K  
1850lm Cri >80



**EAC** IP40  
0,106 m<sup>3</sup>  
3,96 kg



INCLUDED:  
- LED / LED

Dimmerabile TRIAC / Dimmable TRIAC



**LUMI**

A. Saggia & V. Sommella / D&G Studio

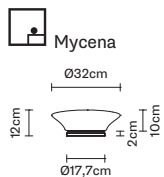

**code**

**electrification**

**technical info**

**accessories**

**F07 B13**  
01 White

E27 220-240V  
1x100W HSGST



**ERC**  **IP40**  
0,035 m<sup>3</sup>  
3,95 kg

NOT INCLUDED:  
- Lampadina / Bulb

E27 220-240V  
1x15W FBG



**F07 B49**  
01 White

LED 220-240V  
1x17W-120°  
WHITE 3000K  
1850lm Cri >80



**ERC**  **IP40**  
0,035 m<sup>3</sup>  
3,11 kg

INCLUDED:  
- LED / LED

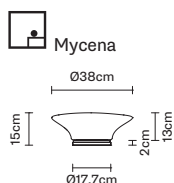

**F07 B15**  
01 White

E27 220-240V  
1x100W HSGST



**ERC**  **IP40**  
0,05 m<sup>3</sup>  
4,35 kg

NOT INCLUDED:  
- Lampadina / Bulb

E27 220-240V  
1x15W FBG



**F07 B51**  
01 White

LED 220-240V  
1x17W-120°  
WHITE 3000K  
1850lm Cri >80



**ERC**  **IP40**  
0,05 m<sup>3</sup>  
4,40 kg

INCLUDED:  
- LED / LED

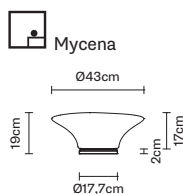

**F07 B17**  
01 White

E27 220-240V  
1x100W HSGST



**ERC**  **IP40**  
0,07 m<sup>3</sup>  
4,23 kg

NOT INCLUDED:  
- Lampadina / Bulb

E27 220-240V  
1x15W FBG



**F07 B53**  
01 White

LED 220-240V  
1x17W-120°  
WHITE 3000K  
1850lm Cri >80



**ERC**  **IP40**  
0,07 m<sup>3</sup>  
4,23 kg

INCLUDED:  
- LED / LED



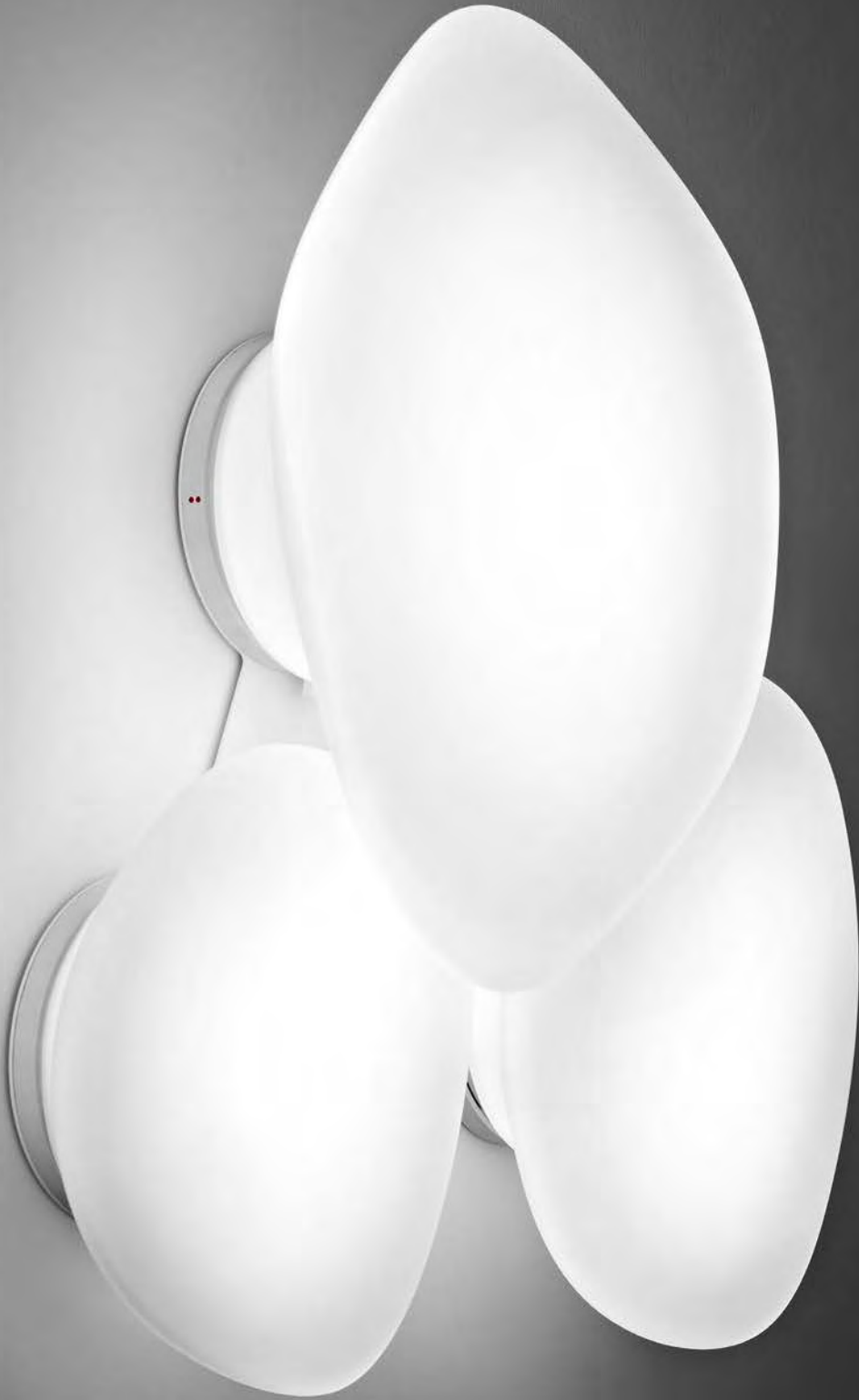

**LUMI**

A. Saggia & V. Sommella / D&G Studio

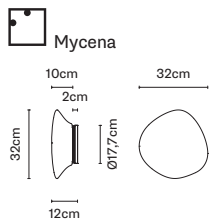

**code**

**electrification**

**technical info**

**accessories**

**F07 G15**  
01 White

E27 220-240V  
1x100W HSGST



**EAC** IP40  
0,035 m<sup>3</sup>  
2,97 kg

NOT INCLUDED:  
- Lampadina / Bulb  
- Base per composizione F07 Z01 01 /  
Base for cluster F07 Z01 01

E27 220-240V  
1x15W FBG



**F07 G39**  
01 White

LED 220-240V  
1x17W-120°  
WHITE 3000K  
1850lm CRI >80



**EAC** IP40  
0,035 m<sup>3</sup>  
2,97 kg

INCLUDED:  
- LED / LED  
  
NOT INCLUDED:  
- Base per composizione F07 Z01 01 /  
Base for cluster F07 Z01 01



Dimmerabile TRIAC / Dimmable TRIAC

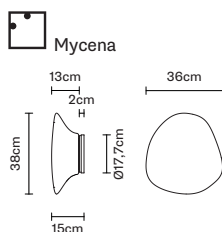

**F07 G17**  
01 White

E27 220-240V  
1x100W HSGST



**EAC** IP40  
0,05 m<sup>3</sup>  
4,09 kg

NOT INCLUDED:  
- Lampadina / Bulb  
- Base per composizione F07 Z01 01 /  
Base for cluster F07 Z01 01

E27 220-240V  
1x15W FBG



**F07 G41**  
01 White

LED 220-240V  
1x17W-120°  
WHITE 3000K  
1850lm CRI >80



**EAC** IP40  
0,05 m<sup>3</sup>  
4,26 kg

INCLUDED:  
- LED / LED  
  
NOT INCLUDED:  
- Base per composizione F07 Z01 01 /  
Base for cluster F07 Z01 01



Dimmerabile TRIAC / Dimmable TRIAC

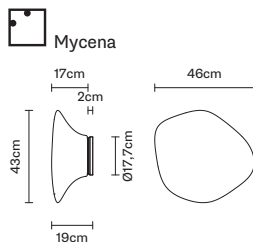

**F07 G19**  
01 White

E27 220-240V  
1x150W HSGST



**EAC** IP40  
0,07 m<sup>3</sup>  
5,31 kg

NOT INCLUDED:  
- Lampadina / Bulb  
- Base per composizione F07 Z01 01 /  
Base for cluster F07 Z01 01

E27 220-240V  
1x15W FBG



**F07 G43**  
01 White

LED 220-240V  
1x17W-120°  
WHITE 3000K  
1850lm CRI >80



**EAC** IP40  
0,07 m<sup>3</sup>  
5,68 kg

INCLUDED:  
- LED / LED  
  
NOT INCLUDED:  
- Base per composizione F07 Z01 01 /  
Base for cluster F07 Z01 01



Dimmerabile TRIAC / Dimmable TRIAC

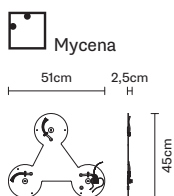

**F07 Z01**  
01 White

**EAC**  
0,069 m<sup>3</sup>  
3,06 kg

NOT INCLUDED:  
- Lampadina / Bulb

Accessorio per composizioni Mycena a parete e soffitto. Per 3 luci: min 1 piccola, max 1 grande / Accessory for wall and ceiling Mycena compositions. For 3 lights: min 1 small, max 1 big



**LUMI**

A. Saggia & V. Sommella / D&G Studio

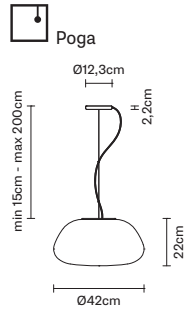

**code**

**electrification**

**technical info**

**accessories**

**F07 A13**  
01 White

E27 220-240V  
1x150W HSGST



**EAC** IP20  
0,108 m<sup>3</sup>  
4,82 kg

INCLUDED:  
- Kit per decentramento / *Off-center cable fastener*

NOT INCLUDED:  
- Lampadina / *Bulb*

E27 220-240V  
1x15W FBG



**F07 A43**  
01 White

LED 220-240V  
1x17W-120°  
WHITE 3000K  
1850lm CRI >80



**EAC** IP20  
0,07 m<sup>3</sup>  
4,14 kg

INCLUDED:  
- LED / *LED*  
- Kit per decentramento / *Off-center cable fastener*



Dimmerabile TRIAC / *Dimmable TRIAC*

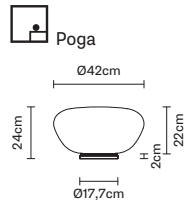

**F07 B19**  
01 White

E27 220-240V  
1x150W HSGST



**EAC** IP40  
0,07 m<sup>3</sup>  
4,00 kg

NOT INCLUDED:  
- Lampadina / *Bulb*

E27 220-240V  
1x15W FBG



**F07 B55**  
01 White

LED 220-240V  
1x17W-120°  
WHITE 3000K  
1850lm CRI >80



**EAC** IP40  
0,05 m<sup>3</sup>  
3,25 kg

INCLUDED:  
- LED / *LED*







**LUMI**

A. Saggia & V. Sommella / D&G Studio

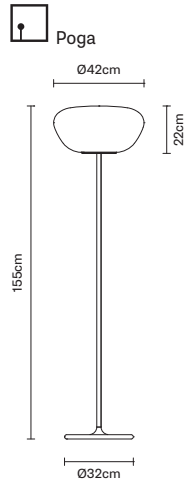

**code**

**electrification**

**technical info**

**accessories**

**F07 C05**  
01 White

E27 220-240V  
1x150W HSGST



**EAC** IP40  
0,208 m<sup>3</sup>  
11,86 kg

NOT INCLUDED:  
- Lampadina / Bulb

E27 220-240V  
1x15W FBG

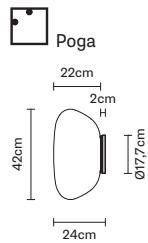

**F07 G21**  
01 White

E27 220-240V  
1x150W HSGST



**EAC** IP40  
0,07 m<sup>3</sup>  
3,69 kg

NOT INCLUDED:  
- Lampadina / Bulb

E27 220-240V  
1x15W FBG



**F07 G45**  
01 White

LED 220-240V  
1x17W-120°  
WHITE 3000K  
1850lm Cri >80



**EAC** IP40  
0,07 m<sup>3</sup>  
3,76 kg

INCLUDED:  
- LED / LED



Dimmerabile TRIAC / Dimmable TRIAC



**LUMI**

A. Saggia & V. Sommella / D&G Studio

**code**

**electrification**

**technical info**

**accessories**



Sfera

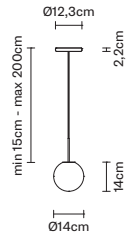

**F07 A17**  
01 White

G9 220-240V  
1x33W HSGS



**EAC** IP40  
0,01 m<sup>3</sup>  
0,85 kg

INCLUDED:  
- Kit per decentramento / *Off-center cable fastener*

NOT INCLUDED:  
- Lampadina / *Bulb*



Sfera

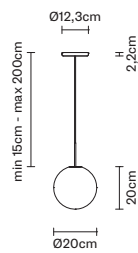

**F07 A19**  
01 White

G9 220-240V  
1x60W HSGS



**EAC** IP40  
0,022 m<sup>3</sup>  
1,24 kg

INCLUDED:  
- Kit per decentramento / *Off-center cable fastener*

NOT INCLUDED:  
- Lampadina / *Bulb*



Sfera

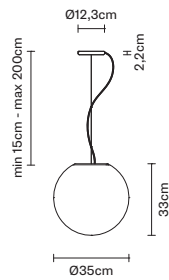

**F07 A21**  
01 White

E27 220-240V  
1x150W HSGST



**EAC** IP20  
0,106 m<sup>3</sup>  
3,99 kg

INCLUDED:  
- Kit per decentramento / *Off-center cable fastener*

NOT INCLUDED:  
- Lampadina / *Bulb*

E27 220-240V  
1x30W FBT



**F07 A45**  
01 White

LED 220-240V  
1x17W-120°  
WHITE 3000K  
1850lm Cri >80



**EAC** IP20  
0,106 m<sup>3</sup>  
3,06 kg

INCLUDED:  
- LED / *LED*  
- Kit per decentramento / *Off-center cable fastener*

Dimmerabile TRIAC / *Dimmable TRIAC*



**LUMI**

A. Saggia & V. Sommella / D&G Studio



Sfera

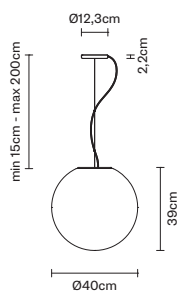

**code**

**electrification**

**technical info**

**accessories**

**F07 A23**  
01 White

E27 220-240V  
1x205W HSGST



**EAC** IP20  
0,106 m<sup>3</sup>  
4,51 kg

INCLUDED:  
- Kit per decentramento / *Off-center cable fastener*

NOT INCLUDED:  
- Lampadina / *Bulb*

E27 220-240V  
1x30W FBT



**F07 A47**  
01 White

LED 220-240V  
1x17W-120°  
WHITE 3000K  
1850lm Cri >80



**EAC** IP20  
0,106 m<sup>3</sup>  
4,07 kg



INCLUDED:  
- LED / *LED*  
- Kit per decentramento / *Off-center cable fastener*

Dimmerabile TRIAC / *Dimmable TRIAC*



Sfera

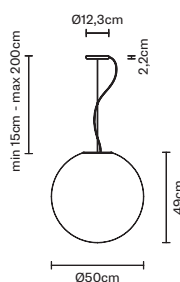

**F07 A25**  
01 White

E27 220-240V  
1x205W HSGST



**EAC** IP20  
0,266 m<sup>3</sup>  
5,89 kg

INCLUDED:  
- Kit per decentramento / *Off-center cable fastener*

NOT INCLUDED:  
- Lampadina / *Bulb*

E27 220-240V  
1x30W FBT



**F07 A49**  
01 White

LED 220-240V  
1x17W-120°  
WHITE 3000K  
1850lm Cri >80



**EAC** IP20  
0,266 m<sup>3</sup>  
7,21 kg



INCLUDED:  
- LED / *LED*  
- Kit per decentramento / *Off-center cable fastener*

Dimmerabile TRIAC / *Dimmable TRIAC*



Sfera

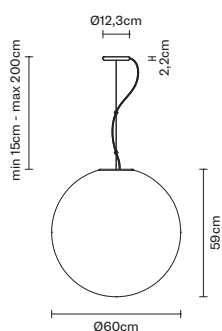

**F07 A27**  
01 White

E27 220-240V  
1x205W HSGST



**EAC** IP20  
0,405 m<sup>3</sup>  
8,57 kg

INCLUDED:  
- Kit per decentramento / *Off-center cable fastener*

NOT INCLUDED:  
- Lampadina / *Bulb*

E27 220-240V  
1x30W FBT



**F07 A51**  
01 White

LED 220-240V  
1x17W-120°  
WHITE 3000K  
1850lm Cri >80



**EAC** IP20  
0,405 m<sup>3</sup>  
9,06 kg



INCLUDED:  
- LED / *LED*  
- Kit per decentramento / *Off-center cable fastener*

Dimmerabile TRIAC / *Dimmable TRIAC*



**LUMI**

A. Saggia & V. Sommella / D&G Studio



Sfera

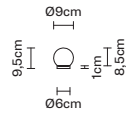

**F07 B23**  
01 White

G9 220-240V  
1x20W HSGS



**EAC**  IP40  
0,005 m<sup>3</sup>  
0,60 kg

NOT INCLUDED:  
- Lampadina / Bulb



Sfera

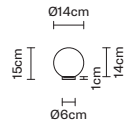

**F07 B25**  
01 White

G9 220-240V  
1x20W HSGS



**EAC**  IP40  
0,01 m<sup>3</sup>  
0,65 kg

NOT INCLUDED:  
- Lampadina / Bulb



Sfera

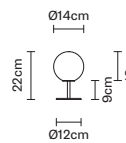

**F07 B27**  
01 White

G9 220-240V  
1x20W HSGS



**EAC**  IP40  
0,012 m<sup>3</sup>  
1,17 kg

NOT INCLUDED:  
- Lampadina / Bulb



Sfera

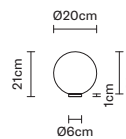

**F07 B29**  
01 White

G9 220-240V  
1x48W HSGS



**EAC**  IP40  
0,022 m<sup>3</sup>  
0,73 kg

NOT INCLUDED:  
- Lampadina / Bulb



Sfera

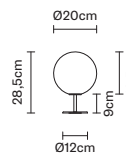

**F07 B31**  
01 White

G9 220-240V  
1x48W HSGS



**EAC**  IP40  
0,027 m<sup>3</sup>  
1,64 kg

NOT INCLUDED:  
- Lampadina / Bulb



Sfera

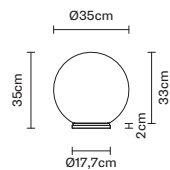

**F07 B33**  
01 White

E27 220-240V  
1x150W HSGST



**EAC**  IP40  
0,106 m<sup>3</sup>  
2,82 kg

NOT INCLUDED:  
- Lampadina / Bulb

E27 220-240V  
1x30W FBT



**F07 B57**  
01 White

LED 220-240V  
1x17W-120°  
WHITE 3000K  
1850lm Cri >80



**EAC**  IP40  
0,106 m<sup>3</sup>  
2,82 kg

INCLUDED:  
- LED / LED



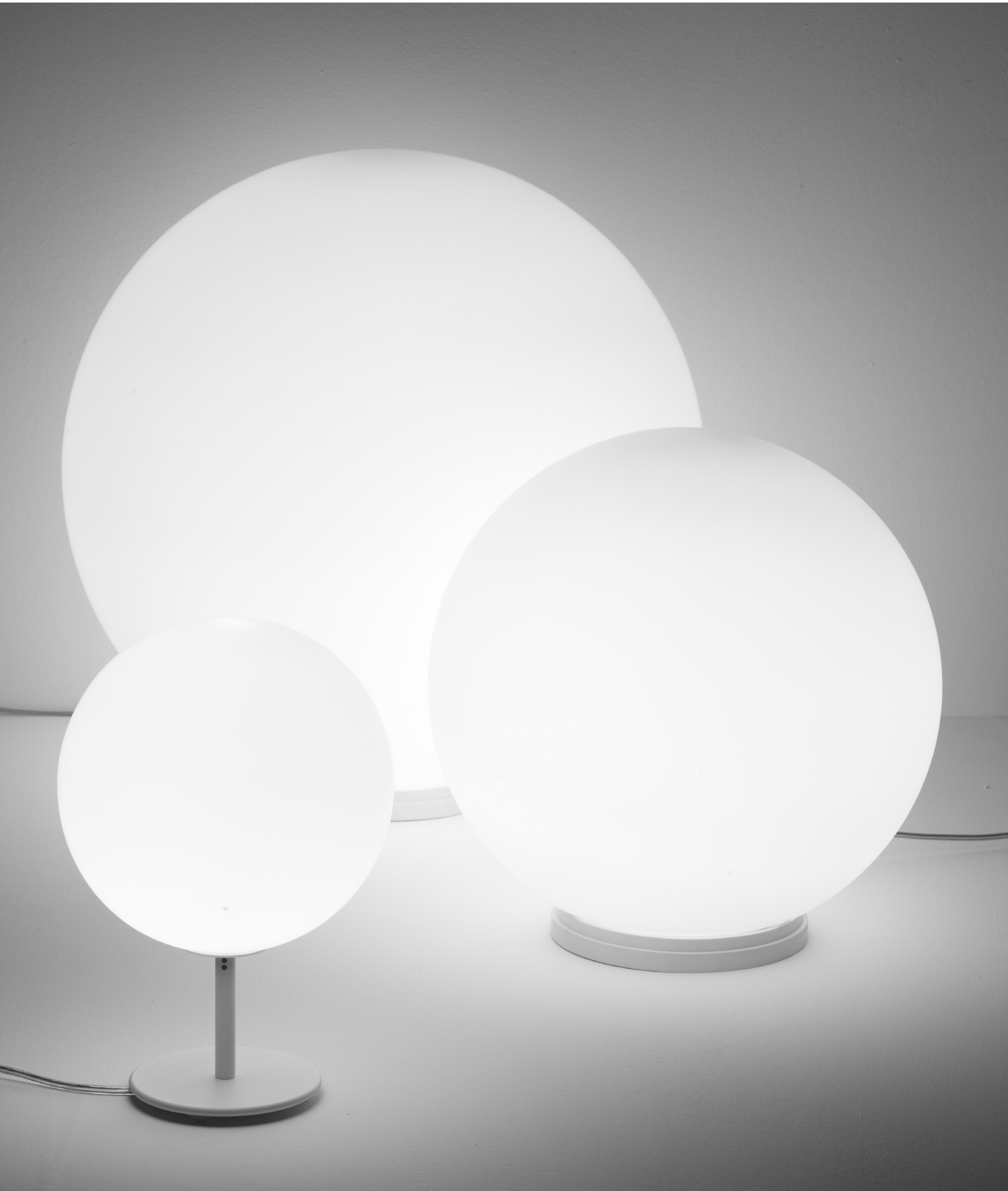



**LUMI**

A. Saggia & V. Sommella / D&G Studio

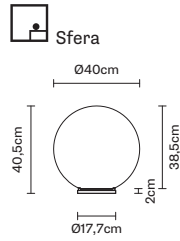

**code**

**electrification**

**technical info**

**accessories**

**F07 B35**  
01 White

E27 220-240V  
1x150W HSGST



**EAC** IP40  
0,106 m<sup>3</sup>  
3,83 kg

NOT INCLUDED:  
- Lampadina / Bulb

E27 220-240V  
1x30W FBT



**F07 B59**  
01 White

LED 220-240V  
1x17W-120°  
WHITE 3000K  
1850lm Cri >80



**EAC** IP40  
0,106 m<sup>3</sup>  
3,83 kg

INCLUDED:  
- LED / LED

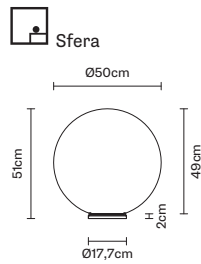

**F07 B37**  
01 White

E27 220-240V  
1x205W HSGST



**EAC** IP40  
0,266 m<sup>3</sup>  
6,86 kg

NOT INCLUDED:  
- Lampadina / Bulb

E27 220-240V  
1x30W FBT



**F07 B61**  
01 White

LED 220-240V  
1x17W-120°  
WHITE 3000K  
1850lm Cri >80



**EAC** IP40  
0,266 m<sup>3</sup>  
2,79 kg

INCLUDED:  
- LED / LED

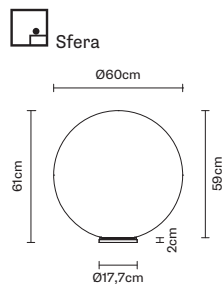

**F07 B39**  
01 White

E27 220-240V  
1x205W HSGST



**EAC** IP40  
0,405 m<sup>3</sup>  
9,06 kg

NOT INCLUDED:  
- Lampadina / Bulb

E27 220-240V  
1x30W FBT



**F07 B63**  
01 White

LED 220-240V  
1x17W-120°  
WHITE 3000K  
1850lm Cri >80



**EAC** IP40  
0,405 m<sup>3</sup>  
9,06 kg

INCLUDED:  
- LED / LED





**LUMI**

A. Saggia & V. Sommella / D&G Studio

**code**

**electrification**

**technical info**

**accessories**



Sfera

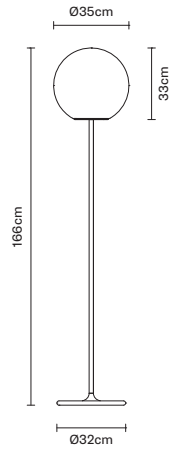

**F07 C09**  
01 White

E27 220-240V  
1x150W HSGST



**EAC**  **IP40**  
0,244 m<sup>3</sup>  
10,92 kg

NOT INCLUDED:  
- Lampadina / Bulb

E27 220-240V  
1x30W FBT



Sfera

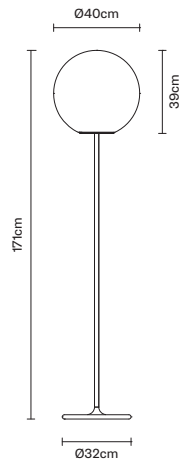

**F07 C11**  
01 White

E27 220-240V  
1x150W HSGST



**EAC**  **IP40**  
0,271 m<sup>3</sup>  
12,10 kg

NOT INCLUDED:  
- Lampadina / Bulb

E27 220-240V  
1x30W FBT



Sfera

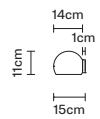

**F07 D01**  
01 White

G9 220-240V  
1x48W HSGS



**EAC**  **IP20**  
0,01 m<sup>3</sup>  
0,74 kg

NOT INCLUDED:  
- Lampadina / Bulb



**LUMI**

A. Saggia & V. Sommella / D&G Studio



Sfera

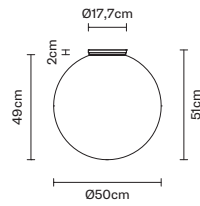

**code**

**electrification**

**technical info**

**accessories**

**F07 E33**  
01 White

E27 220-240V  
1x205W HSGST



**EAC** IP40  
0,266 m<sup>3</sup>  
6,09 kg

NOT INCLUDED:  
- Lampadina / Bulb

E27 220-240V  
1x30W FBT



**F07 E51**  
01 White

LED 220-240V  
1x17W-120°  
WHITE 3000K  
1850lm Cri >80



**EAC** IP40  
0,266 m<sup>3</sup>  
6,47 kg

INCLUDED:  
- LED / LED

Dimmerabile TRIAC / Dimmable TRIAC



Sfera

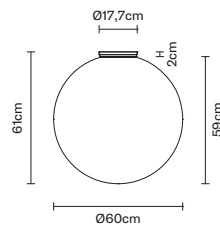

**F07 E09**  
01 White

E27 220-240V  
1x205W HSGST



**EAC** IP40  
0,405 m<sup>3</sup>  
8,48 kg

NOT INCLUDED:  
- Lampadina / Bulb

E27 220-240V  
1x30W FBT



**F07 E15**  
01 White

LED 220-240V  
1x17W-120°  
WHITE 3000K  
1850lm Cri >80



**EAC** IP40  
0,405 m<sup>3</sup>  
3,34 kg

INCLUDED:  
- LED / LED

Dimmerabile TRIAC / Dimmable TRIAC



**LUMI**

A. Saggia & V. Sommella / D&G Studio

**code**

**electrification**

**technical info**

**accessories**



Sfera

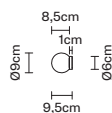

**F07 G23**  
01 White

G9 220-240V  
1x20W HSGS



**EAC** IP44  
0,005 m<sup>3</sup>  
0,32 kg

NOT INCLUDED:  
- Lampadina / Bulb



Sfera

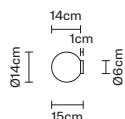

**F07 G25**  
01 White

G9 220-240V  
1x33W HSGS



**EAC** IP44  
0,01 m<sup>3</sup>  
0,65 kg

NOT INCLUDED:  
- Lampadina / Bulb



Sfera

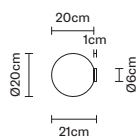

**F07 G27**  
01 White

G9 220-240V  
1x60W HSGS



**EAC** IP44  
0,022 m<sup>3</sup>  
0,94 kg

NOT INCLUDED:  
- Lampadina / Bulb



Sfera

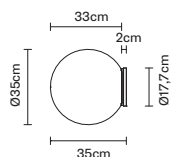

**F07 G29**  
01 White

E27 220-240V  
1x150W HSGST



**EAC** IP40  
0,106 m<sup>3</sup>  
3,88 kg

NOT INCLUDED:  
- Lampadina / Bulb

E27 220-240V  
1x30W FBT



**F07 G47**  
01 White

LED 220-240V  
1x17W-120°  
WHITE 3000K  
1850lm CRI >80



**EAC** IP40  
0,106 m<sup>3</sup>  
3,42 kg

INCLUDED:  
- LED / LED

Dimmerabile TRIAC / Dimmable TRIAC



Sfera

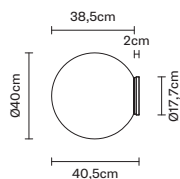

**F07 G31**  
01 White

E27 220-240V  
1x150W HSGST



**EAC** IP40  
0,106 m<sup>3</sup>  
3,91 kg

NOT INCLUDED:  
- Lampadina / Bulb

E27 220-240V  
1x30W FBT



**F07 G49**  
01 White

LED 220-240V  
1x17W-120°  
WHITE 3000K  
1850lm CRI >80



**EAC** IP40  
0,106 m<sup>3</sup>  
3,83 kg

INCLUDED:  
- LED / LED

Dimmerabile TRIAC / Dimmable TRIAC





**LUMI**

A. Saggia & V. Sommella / D&G Studio

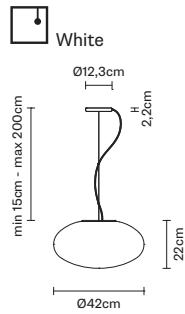

**code**

**electrification**

**technical info**

**accessories**

**F07 A09**  
01 White

E27 220-240V  
1x150W HSGST



**EAC** IP20  
0,108 m<sup>3</sup>  
4,77 kg

INCLUDED:  
- Kit per decentramento / *Off-center cable fastener*

NOT INCLUDED:  
- Lampadina / *Bulb*

E27 220-240V  
1x22W FBT



**F07 A53**  
01 White

LED 220-240V  
1x17W-120°  
WHITE 3000K  
1850lm CRI >80



**EAC** IP20  
0,108 m<sup>3</sup>  
6,11 kg

INCLUDED:  
- LED / LED  
- Kit per decentramento / *Off-center cable fastener*

Dimmerabile TRIAC / *Dimmable TRIAC*



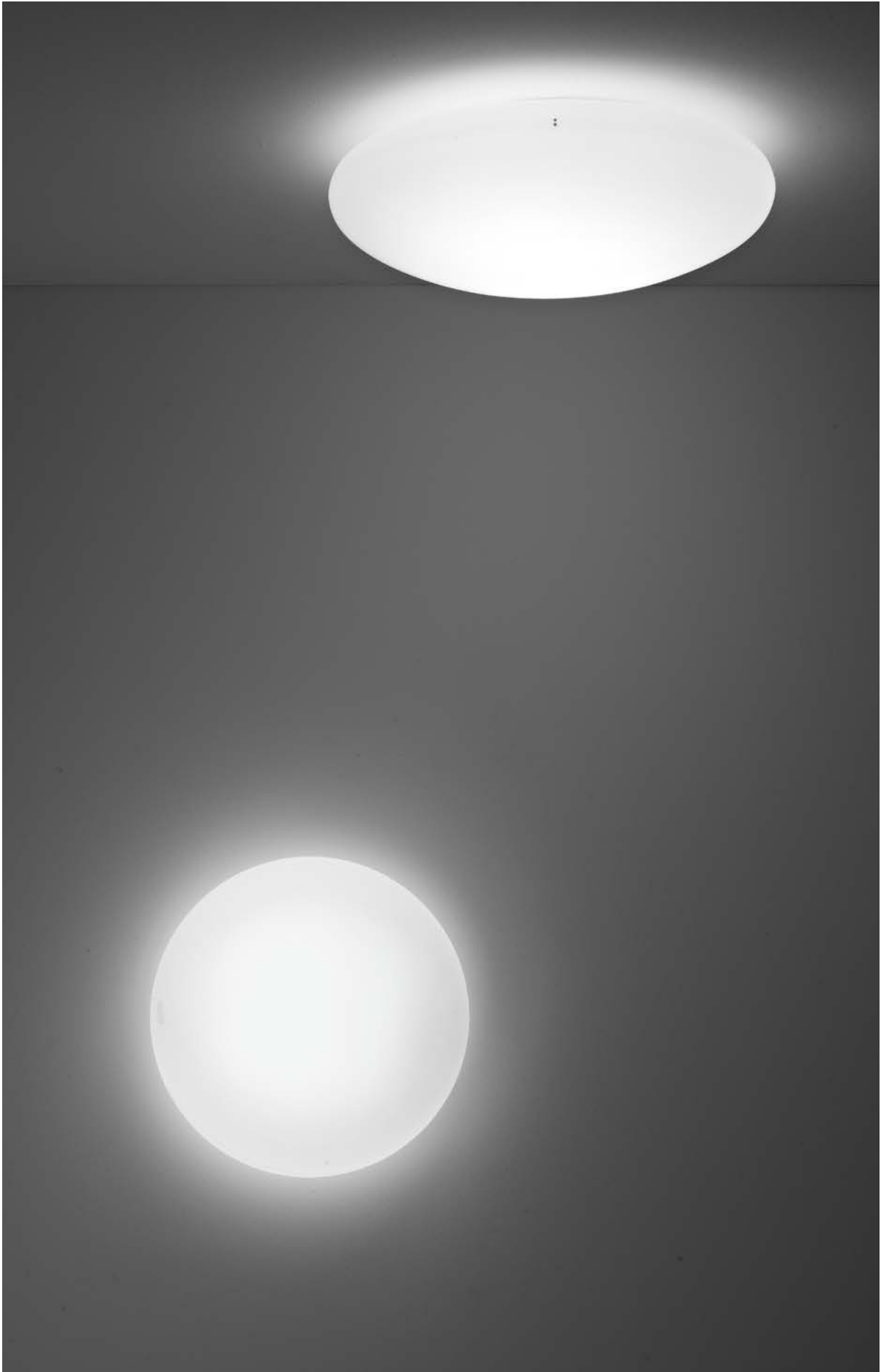

**LUMI**

A. Saggia & V. Sommella / D&G Studio

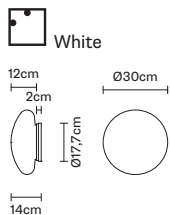

**code**

**electrification**

**technical info**

**accessories**

**F07 G09**  
01 White

E27 220-240V  
1x100W HSGST



**EAC** IP40  
0,035 m<sup>3</sup>  
2,28 kg

NOT INCLUDED:  
- Lampadina / Bulb

E27 220-240V  
1x15W FBG



**F07 G53**  
01 White

LED 220-240V  
1x17W-120°  
WHITE 3000K  
1850lm CRI >80



**EAC** IP40  
0,035 m<sup>3</sup>  
2,43 kg



INCLUDED:  
- LED / LED

Dimmerabile TRIAC / Dimmable TRIAC

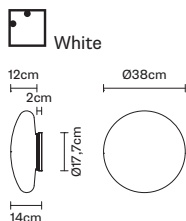

**F07 G11**  
01 White

E27 220-240V  
1x150W HSGST



**EAC** IP40  
0,05 m<sup>3</sup>  
3,59 kg

NOT INCLUDED:  
- Lampadina / Bulb

E27 220-240V  
1x15W FBG



**F07 G55**  
01 White

LED 220-240V  
1x17W-120°  
WHITE 3000K  
1850lm CRI >80



**EAC** IP40  
0,05 m<sup>3</sup>  
3,69 kg



INCLUDED:  
- LED / LED

Dimmerabile TRIAC / Dimmable TRIAC

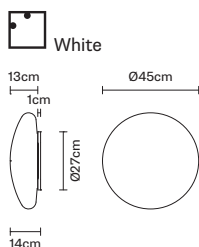

**F07 G13**  
01 White

E27 220-240V  
2x100W HSGST



**EAC** IP40  
0,069 m<sup>3</sup>  
5,41 kg

NOT INCLUDED:  
- Lampadina / Bulb

E27 220-240V  
2x15W FBG



**F07 G57**  
01 White

LED 220-240V  
1x17W-120°  
WHITE 3000K  
1850lm CRI >80



**EAC** IP40  
0,069 m<sup>3</sup>  
5,41 kg



INCLUDED:  
- LED / LED

Dimmerabile TRIAC / Dimmable TRIAC

# MONO&EASY

—  
Massimo Sacconi



La collezione è costituita da apparecchi d'illuminazione ad incasso per interno. I diffusori sono in vetro soffiato bianco satinato; per Mono la struttura metallica è verniciata bianca; per Easy la struttura è in metallo cromato lucido. Questi faretti sono adatti ad ogni tipo di ambiente grazie alla loro semplice ed elegante forma. L'elettrificazione a bassissima tensione (12V) per lampade alogene, e a tensione di rete per lampade alogene e fluorescenti. Easy è disponibile anche a LED in corrente continua (700mA).

La colección está compuesta por focos de empotrar de interior. Los difusores son de vidrio soplado blanco satinado; para Mono la estructura metálica está pintada de color blanco y para Easy la estructura es de metal cromado brillante. Estos focos son idóneos para todos los tipos de ambiente por sus formas sencillas y elegantes. La electrificación es con tensión muy baja (12V) para bombillas halógenas y con tensión de red para bombillas halógenas y fluorescentes. Easy está disponible también con LED en corriente continua (700mA).

Die Kollektion besteht aus Einbau-Beleuchtungen für Innenbereiche. Die Diffusoren sind aus satiniertem, weißem und geblasenem Glas; Mono weist eine weiß lackierte, Easy dagegen eine glanzverchromte Metallstruktur auf. Diese Spotlights eignen sich für jede Umgebung dank ihrer einfachen und eleganten Form. Die Elektrifizierung mit Niederspannung (12V) für Halogenlampen und mit Netzspannung für Halogen- und Fluoreszenzlampen. Easy ist auch mit LED und Gleichstrom erhältlich (700 mA).

The collection is made up of recessed lighting fixtures for indoor use. The diffusers are in satin-finished white blown glass; for the Mono series, the metallic structure is painted white, for the Easy series, the structure is in polished chrome metal. The simple, elegant shape of these spotlights makes them perfect in every setting. The lamps run on a very low voltage (12V) for halogen bulbs and mains power for halogen and fluorescent bulbs. Easy is also available for LED bulbs in D/C (700mA).

La collection est constituée par des corps d'éclairage à encastrer pour intérieur. Les diffuseurs sont en verre soufflé blanc satiné; la structure métallique de Mono est vernie en blanc; la structure d'Easy, quant à elle, est en métal chromé brillant. Ces spots sont adaptés à tout type d'espace grâce à leur forme simple et élégante. Les lampes halogènes sont alimentées à très basse tension (12V) et les lampes halogènes et fluorescentes sont alimentées par la tension du réseau. Easy est également disponible avec des LED en courant continu (700mA).

Коллекция состоит из встраиваемых осветительных приборов для внутренних помещений. Рассеиватели из выдувного белого матированного стекла; структура прожекторов Mono из металла с белым лаковым покрытием; структура прожекторов Easy из блестящего хромированного металла. Эти прожекторы подходят для различных интерьеров благодаря простой и изящной форме. Электрическая часть рассчитана на галогеновые лампы для очень низкого напряжения (12V), на галогеновые и люминесцентные лампы от сетевого напряжения. Easy имеет вариант со светодиодами от постоянного напряжения (700mA).





**MONO&EASY**  
Massimo Sacconi

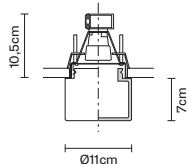

**code**      **electrification**      **technical info**      **accessories**

**D14 F36**  
01 White

E27 220-240V  
1x46W HSGSA



**EAC**  IP20  
IP44  
0,007 m<sup>3</sup>  
0,69 kg

NOT INCLUDED:  
- Lampadina / Bulb

E27 220-240V  
1x11W FBT



**D14 F37**  
01 White

GU10 220-240V  
1x75W HAGS/UB



**EAC**  IP20  
IP44  
  
0,007 m<sup>3</sup>  
0,88 kg

NOT INCLUDED:  
- Lampadina / Bulb

GU10 220-240V  
1x5,5W



**D14 F39**  
01 White

GX24q-2 220-240V  
1x18W FSQ



**EAC**  IP20  
IP44  
0,007 m<sup>3</sup>  
0,88 kg

NOT INCLUDED:  
- Lampadina / Bulb  
- Alimentatore / Driver

**D14 F54**  
01 White

LED 700mA  
1x14W-40°  
WHITE 3000K  
1200lm Cri >80



**EAC**  IP20  
IP44  
0,007 m<sup>3</sup>  
0,88 kg

INCLUDED:  
- LED / LED  
  
NOT INCLUDED:  
- Alimentatore / Driver

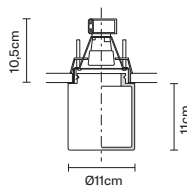

**D14 F40**  
01 White

E27 220-240V  
1x46W HSGSA



**EAC**  IP20  
IP44  
0,012 m<sup>3</sup>  
1,06 kg

NOT INCLUDED:  
- Lampadina / Bulb

E27 220-240V  
1x18W FBT



**D14 F56**  
01 White

LED 700mA  
1x14W-40°  
WHITE 3000K  
1200lm Cri >80



**EAC**  IP20  
IP44  
0,007 m<sup>3</sup>  
0,88 kg

INCLUDED:  
- LED / LED  
  
NOT INCLUDED:  
- Alimentatore / Driver



# MULTISPOT

Marc Sadler / Nanne de Ru / Flynn Talbot









## CONCEPT

---

La continua ricerca dell'esclusività ha portato alla luce una lampada dalla forma personalizzata, unica, preziosa: Multispot. Questo particolare sistema componibile nasce per dare al progettista la possibilità di stabilire le altezze dei diffusori e la posizione dei punti luce adattando quindi la lampada al progetto. Il prodotto si può adattare perfettamente a qualsiasi ambiente grazie anche alla varietà di dimensioni del rosone ed è ideale per impreziosire grandi spazi donando un'atmosfera incantevole e suggestiva. Su richiesta le lampade Multispot sono interamente personalizzabili.

Constant research for exclusive touches has led to the creation of a lamp with a personalised, unique and exquisite shape: Multispot. The particular modular system was designed to give the architect the possibility of establishing the heights at which to position diffusers and lighting points, thus adapting the lamp to any project. The product can be perfectly adapted to suit any environment thanks also to the range of different sizes of ceiling rose available. It is ideal for adding a touch of glamour and charm to large areas. On request, Multispot lamps can be entirely customised.

La búsqueda continua de la exclusividad ha sacado a la luz una lámpara con una forma personalizada, única, preciosa: Multispot. Este sistema modular especial se crea para permitir al proyectista establecer las alturas de los difusores y la posición de los puntos de luz con el fin de adaptar la lámpara al proyecto. El producto se adapta perfectamente a todos los ambientes también por la variedad de dimensiones del rosetón y es ideal para embellecer espacios grandes a los que regala una atmósfera mágica y sugestiva. Las lámparas Multispot son totalmente personalizables bajo pedido.

Die ständige Suche nach Exklusivität hat eine Lampe mit einer individuellen, einzigartigen und wertvollen Form ans Licht gebracht: Multispot. Dieses besondere zusammensetzbare System entstand, um dem Designer die Möglichkeit zu geben, die Höhen der Diffusoren und die Position der Lichtpunkte festzusetzen und somit die Lampe dem Projekt anzupassen. Das Produkt eignet sich perfekt für jede Umgebung, auch dank der verschiedenen Abmessungen der Rosette, und ist ideal, um große Räume aufzuwerten, denen es eine bezaubernde und suggestive Atmosphäre verleiht. Auf Wunsch können die Lampen Multispot ganz individuell gestaltet werden.

La recherche continue de l'exclusivité nous a mené sur une lampe à la forme personnalisée, unique et précieuse: Multispot. Ce système particulier modulable a été créé pour donner à l'architecte la possibilité d'établir les hauteurs des diffuseurs et la position des points de lumière en adaptant donc la lampe au projet. Le produit peut s'adapter parfaitement à tout espace grâce à la variété des dimensions de la rosace et est idéal pour enrichir les grands espaces, tout en offrant une atmosphère charmante et suggestive. Sur demande, les lampes Multispot peuvent être entièrement personnalisées.

Постоянный поиск эксклюзивности в освещении привел к созданию лампы уникальной, значимой формы, которая может видоизменяться под ваши требования: Multispot. Эта необычная композиционная система создана специально, чтобы дать возможность архитектору определять высоту рассеивателей и местоположение точек света, и таким образом модифицировать освещение под требования проекта. Эта подвесная люстра прекрасно смотрится в различных архитектурных решениях, благодаря широкому выбору размеров розетки. Люстра идеально подходит для установки в больших пространствах, которым она придает завораживающую и таинственную атмосферу. Люстры Multispot могут быть произведены специально под индивидуальный заказ.

# MULTISPOT BELUGA

La collezione Beluga si compone di sospensioni per interno ed esterno. I rosoni, di forma e dimensioni diverse, sono in alluminio verniciato a polveri bianchi e possono essere forniti con le forature massime previste, oppure possono essere personalizzati su richiesta. I diffusori di Beluga, forniti in 4 lunghezze di cavo elettrico, sono costituiti da sfere in cristallo trasparente. L'elettrificazione è a tensione di rete per Led.

La colección Beluga está compuesta por lámparas colgantes de interior y exterior. Los rosetones, con formas y tamaños diferentes, son de aluminio pintado con polvos blancos y se pueden suministrar con los orificios máximos previstos o bien se personalizan bajo pedido. Los difusores de Beluga, suministrados con un cable eléctrico en 4 longitudes, están constituidos por esferas de cristal transparente. La electrificación es con tensión de red para Led.

Die Kollektion Beluga besteht aus Hängelampen für Innenbereiche und Aussbereiche. Die Rosetten mit unterschiedlichen Formen und Abmessungen sind aus weiß pulverlackiertem Alu und können mit den vorgesehenen Höchstbohrungen geliefert oder nach Wunsch individuell gestaltet werden. Die Diffusoren von Beluga in 4 Stromkabelängen bestehen aus transparenten Kristallglaskugeln. Die Elektrifizierung erfolgt über Netzspannung bei LED-Lampen.

The Beluga collection is made up of hanging lamps for indoor and outdoor use. The ceiling roses, in different shapes and sizes, are made in white painted aluminium and come either with the standard maximum number of holes, or customised on request. The diffusers of the Beluga series, available in 4 lengths of electrical cable, are composed of transparent lead crystal spheres. The lamp runs on mains power and is suitable for use with LED.

La collection Beluga se compose de suspensions pour intérieur et l'extérieur. Les rosaces, de différentes formes et dimensions sont en aluminium peint en blanc par poudre et peuvent être fournies avec les trous maximums prévus, ou personnalisées sur demande. Les diffuseurs de Beluga, fournis avec 4 longueurs de câble électrique se composent de sphères en cristal transparent. Les LED sont alimentées par la tension du réseau.

Коллекция Beluga состоит из подвесок для внутренних помещений и внешней. Розетки разных форм и размеров из алюминия с белой порошковой окраской могут поставляться с максимально широкими отверстиями, или могут производиться под ваш индивидуальный заказ. Рассеиватели люстры Beluga имеют электрический шнур 4-х разных длин, состоят из сфер из прозрачного кристалла. Электрическая часть рассчитана на светодиодные лампы от сети напряжения.





**MULTISPOT BELUGA**

Marc Sadler

**code**                      **electrification**                      **technical info**                      **accessories**

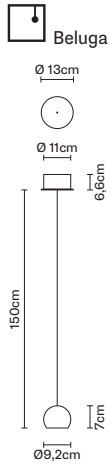

**F32 A21**  
**00 Transparent**

LED 220-240V  
1x3W-140°  
WHITE 3000K  
230lm Cri >80



**EAC** IP40  
IP55  
0,008 m<sup>3</sup>  
1.485,00 kg



**INCLUDED:**  
- LED / LED  
- Driver elettronico dimmerabile /  
*Dimmable electronic driver*

Lampadario a 1 luce. Rosone verniciato bianco. Lampadario già cablato / 1 spot chandelier. White painted canopy. Already wired

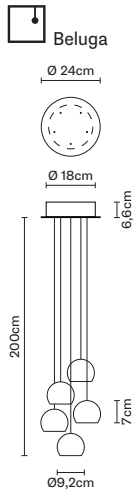

**F32 A22**  
**00 Transparent**

LED 220-240V  
5x3W-140°  
WHITE 3000K  
1150lm Cri >80



**EAC** IP40  
IP55  
0,024 m<sup>3</sup>  
5.925,00 kg



**INCLUDED:**  
- LED / LED  
- Driver elettronico dimmerabile /  
*Dimmable electronic driver*

Lampadario a 5 luci. Rosone verniciato bianco. Lampadario già cablato / 5 spots chandelier. White painted canopy. Already wired

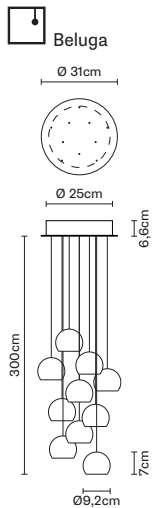

**F32 A23**  
**00 Transparent**

LED 220-240V  
10x3W-140°  
WHITE 3000K  
2300lm Cri >80



**EAC** IP40  
IP55  
0,05 m<sup>3</sup>  
10.755,00 kg



**INCLUDED:**  
- LED / LED  
- Driver elettronico dimmerabile /  
*Dimmable electronic driver*

Lampadario a 10 luci. Rosone verniciato bianco. Lampadario già cablato / 10 spots chandelier. White painted canopy. Already wired

## MULTISPOT BELUGA

Marc Sadler

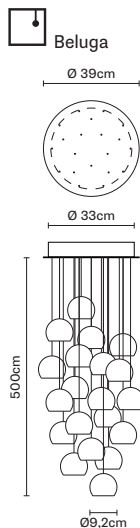

**code**

**electrification**

**technical info**

**accessories**

**F32 A24**  
**00 Transparent**

LED 220-240V  
20x3W-140°  
WHITE 3000K  
4600lm CRI >80



**EAC** IP40  
IP55  
0,099 m<sup>3</sup>  
20,37 kg



INCLUDED:

- LED / LED
- Driver elettronico dimmerabile / Dimmable electronic driver

Lampadario a 20 luci. Rosone verniciato bianco. Lampadario già cablato / 20 spots chandelier. White painted canopy. Already wired

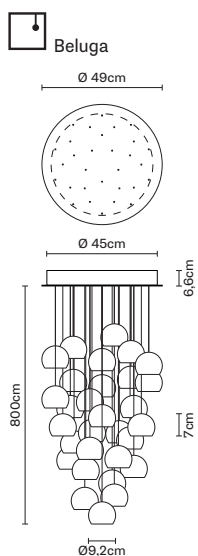

**F32 A25**  
**00 Transparent**

LED 220-240V  
30x3W-140°  
WHITE 3000K  
6900lm CRI >80



**EAC** IP40  
IP55  
0,142 m<sup>3</sup>  
30,25 kg



INCLUDED:

- LED / LED
- Driver elettronico dimmerabile / Dimmable electronic driver

Lampadario a 30 luci. Rosone verniciato bianco. Lampadario già cablato / 30 spots chandelier. White painted canopy. Already wired

## MULTISPOT BELUGA

Marc Sadler

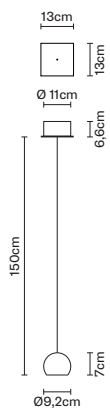

**code**

**electrification**

**technical info**

**accessories**

**F32 A26**  
00 Transparent

LED 220-240V  
1x3W-140°  
WHITE 3000K  
230lm CRI >80



**EAC** IP40  
IP55  
0,008 m<sup>3</sup>  
1,625,00 kg



INCLUDED:  
- LED / LED  
- Driver elettronico dimmerabile /  
Dimmable electronic driver

Lampadario a 1 luce. Rosone verniciato bianco. Lampadario già cablato / 1 spot chandelier. White painted canopy. Already wired

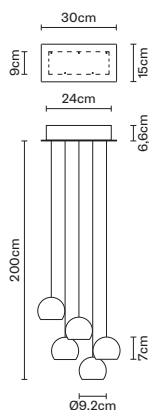

**F32 A27**  
00 Transparent

LED 220-240V  
5x3W-140°  
WHITE 3000K  
1150lm CRI >80



**EAC** IP40  
IP55  
0,027 m<sup>3</sup>  
5,95 kg



INCLUDED:  
- LED / LED  
- Driver elettronico dimmerabile /  
Dimmable electronic driver

Lampadario a 5 luci. Rosone verniciato bianco. Lampadario già cablato / 5 spots chandelier. White painted canopy. Already wired

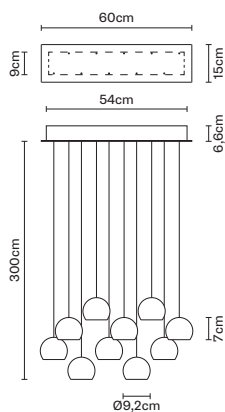

**F32 A28**  
00 Transparent

LED 220-240V  
10x3W-140°  
WHITE 3000K  
2300lm CRI >80



**EAC** IP40  
IP55  
0,068 m<sup>3</sup>  
10,475,00 kg



INCLUDED:  
- LED / LED  
- Driver elettronico dimmerabile /  
Dimmable electronic driver

Lampadario a 10 luci. Rosone verniciato bianco. Lampadario già cablato / 10 spots chandelier. White painted canopy. Already wired



## MULTISPOT BELUGA

Marc Sadler



Beluga

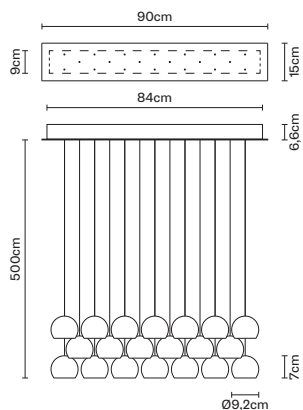

**code**

**electrification**

**technical info**

**accessories**

**F32 A29**  
**00 Transparent**

LED 220-240V  
20x3W-140°  
WHITE 3000K  
4600lm Cri >80



**EAC** IP40  
IP55  
0,133 m<sup>3</sup>  
21,21 kg



INCLUDED:

- LED / LED
- Driver elettronico dimmerabile / Dimmable electronic driver

Lampadario a 20 luci. Rosone verniciato bianco. Lampadario già cablato / 20 spots chandelier. White painted canopy. Already wired



Beluga

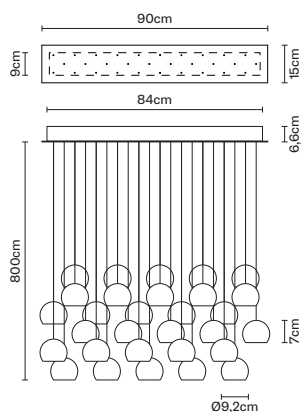

**F32 A30**  
**00 Transparent**

LED 220-240V  
30x3W-140°  
WHITE 3000K  
6900lm Cri >80



**EAC** IP40  
IP55  
0,167 m<sup>3</sup>  
29.095,00 kg



INCLUDED:

- LED / LED
- Driver elettronico dimmerabile / Dimmable electronic driver

Lampadario a 30 luci. Rosone verniciato bianco. Lampadario già cablato / 30 spots chandelier. White painted canopy. Already wired

# MULTISPOT TOOBY

La collezione Tooby si compone di sospensioni per interno ed esterno. I rosoni, di forma e dimensioni diverse, sono in alluminio verniciato a polveri bianchi e possono essere forniti con le forature massime previste, oppure possono essere personalizzati su richiesta. I diffusori di Tooby, forniti in 4 lunghezze di cavo elettrico, sono costituiti da elementi cilindrici in vetro borosilicato (Pyrex®) e tappo in finitura anodizzata e ramata lucida, con all'interno un elemento cilindrico plastico rigato per diffondere la luce omogeneamente lungo tutto il tubo. L'elettrificazione è a tensione di rete per Led.

La colección Tooby está compuesta por lámparas colgantes de interior y exterior. Los rosetones, con formas y tamaños diferentes, son de aluminio pintado con polvos blancos y se pueden suministrar con los orificios máximos previstos o bien se personalizan bajo pedido. Los difusores de Tooby, suministrados con un cable eléctrico en 4 longitudes, están constituidos por elementos cilíndricos de vidrio borosilicato (Pyrex®) y tapón con acabado anodizado y cobrizo brillante, con en el interior un elemento cilíndrico de plástico rayado para difundir la luz uniformemente a lo largo de todo el tubo. La electrificación es con tensión de red para Led.

Die Kollektion Tooby besteht aus Hängelampen für Innenbereiche und Aussbereiche. Die Rosetten mit unterschiedlichen Formen und Abmessungen sind aus weiß pulverlackiertem Alu und können mit den vorgesehenen Höchstbohrungen geliefert oder nach Wunsch individuell gestaltet werden. Die Diffusoren von Tooby in 4 Stromkabelängen bestehen aus zylindrischen Elementen aus Borosilikatglas (Pyrex®) und einem eloxierten kupferpolierten Verschluss mit einem gerillten inneren Kunststoffzylinder, um das Licht gleichmäßig entlang des ganzen Rohrs zu verteilen. Die Elektrifizierung erfolgt über Netzspannung bei LED-Lampen.

The Tooby collection is made up of hanging lamps for indoor and outdoor use. The ceiling roses, in different shapes and sizes, are made in white painted aluminium and come either with the standard maximum number of holes, or customised on request. The diffusers of the Tooby series, available in 4 lengths of electrical cable, are composed of cylindrical elements in borosilicate glass (Pyrex®) and a cap with an anodised and shiny copper finish, with a ribbed plastic cylindrical element inside to diffuse the light evenly along the entire tube. The lamp runs on mains power and is suitable for use with LED.

La collection Tooby se compose de suspensions pour l'intérieur et l'extérieur. Les rosaces, de différentes formes et dimensions, sont en aluminium peint en blanc par poudre et peuvent être fournies avec les trous prévus au maximum ou personnalisées sur demande. Les diffuseurs de Tooby, fournis avec 4 longueurs de câble électrique, sont constitués par des éléments en verre borosilicate (Pyrex®) et par une couverture finition anodisée cuivre brillant, avec un élément cylindrique en plastique rayé à l'intérieur pour une lumière homogène le long du tube. Les LED sont alimentées par la tension du réseau.

Коллекция Тоуби состоит из подвесок для внутренних помещений и внешней. Розетки разных форм и размеров из алюминия с белой порошковой окраской могут поставляться с максимально широкими отверстиями, или могут производиться под ваш индивидуальный заказ. Рассеиватели люстры Тоуби имеют электрический шнур 4-х разных длин, состоят из цилиндрических элементов из боросиликатного стекла (Pyrex®) и колпачка с анодированной и глянцевой медной отделкой; внутри имеется пластиковый цилиндр в полосу для однородного рассеивания света по всей длине лампы. Электрическая часть рассчитана на светодиодные лампы от сети напряжения.





**MULTISPOT TOOBY**

Nanne de Ru

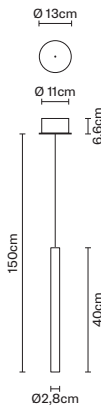

**code**

**electrification**

**technical info**

**accessories**

**F32 A01**  
00 Transparent

LED 220-240V  
1x2.1W-10°  
WHITE 2700K  
200lm Cri >80

**EAC** IP40  
IP55  
0,008 m<sup>3</sup>  
1.125,00 kg

INCLUDED:  
- LED / LED  
- Driver elettronico dimmerabile /  
Dimmable electronic driver



Lampadario a 1 luce. Rosone verniciato bianco, montatura in alluminio anodizzato.  
Lampadario già cablato / Single spot chandelier. White painted canopy, anodized aluminium structure. Already wired

**F32 A11**  
00 Transparent

LED 220-240V  
1x2.1W-10°  
WHITE 2700K  
200lm Cri >80

**EAC** IP40  
IP55  
0,008 m<sup>3</sup>  
1.125,00 kg

INCLUDED:  
- LED / LED  
- Driver elettronico dimmerabile /  
Dimmable electronic driver



Lampadario a 1 luce. Rosone verniciato bianco, montatura in alluminio ramato lucido.  
Lampadario già cablato / Single spot chandelier. White painted canopy, copper-plated aluminium structure. Already wired

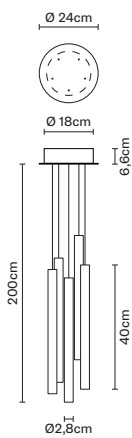

**F32 A02**  
00 Transparent

LED 220-240V  
5x2.1W-10°  
WHITE 2700K  
1000lm Cri >80

**EAC** IP40  
IP55  
0,027 m<sup>3</sup>  
3,94 kg

INCLUDED:  
- LED / LED  
- Driver elettronico dimmerabile /  
Dimmable electronic driver



Lampadario a 5 luci. Rosone verniciato bianco, montatura in alluminio anodizzato.  
Lampadario già cablato / 5 spots chandelier. White painted canopy, anodized aluminium structure. Already wired

**F32 A12**  
00 Transparent

LED 220-240V  
5x2.1W-10°  
WHITE 2700K  
1000lm Cri >80

**EAC** IP40  
IP55  
0,027 m<sup>3</sup>  
3,94 kg

INCLUDED:  
- LED / LED  
- Driver elettronico dimmerabile /  
Dimmable electronic driver



Lampadario a 5 luci. Rosone verniciato bianco, montatura in alluminio ramato lucido.  
Lampadario già cablato / 5 spots chandelier. White painted canopy, copper-plated aluminium structure. Already wired

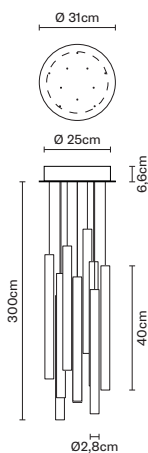

**F32 A03**  
00 Transparent

LED 220-240V  
10x2.1W-10°  
WHITE 2700K  
2000lm Cri >80

**EAC** IP40  
IP55  
0,056 m<sup>3</sup>  
7.185,00 kg

INCLUDED:  
- LED / LED  
- Driver elettronico dimmerabile /  
Dimmable electronic driver



Lampadario a 10 luci. Rosone verniciato bianco, montatura in alluminio anodizzato.  
Lampadario già cablato / 10 spots chandelier. White painted canopy, anodized aluminium structure. Already wired

**F32 A13**  
00 Transparent

LED 220-240V  
10x2.1W-10°  
WHITE 2700K  
2000lm Cri >80

**EAC** IP40  
IP55  
0,056 m<sup>3</sup>  
7.185,00 kg

INCLUDED:  
- LED / LED  
- Driver elettronico dimmerabile /  
Dimmable electronic driver



Lampadario a 10 luci. Rosone verniciato bianco, montatura in alluminio ramato lucido.  
Lampadario già cablato / 10 spots chandelier. White painted canopy, copper-plated aluminium structure. Already wired

**MULTISPOT TOOBY**

Nanne de Ru

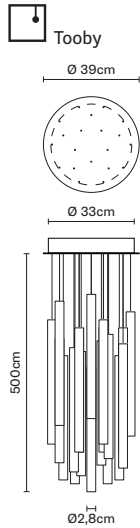

**code**

**electrification**

**technical info**

**accessories**

**F32 A04**  
00 Transparent

LED 220-240V  
20x2.1W-10°  
WHITE 2700K  
4000lm CRI >80

**EAC** IP40  
IP55  
0,109 m³  
13,23 kg

INCLUDED:  
- LED / LED  
- Driver elettronico dimmerabile /  
Dimmable electronic driver

Lampadario a 20 luci. Rosone verniciato bianco, montatura in alluminio anodizzato. Lampadario già cablato / 20 spots chandelier. White painted canopy, anodized aluminium structure. Already wired

**F32 A14**  
00 Transparent

LED 220-240V  
20x2.1W-10°  
WHITE 2700K  
4000lm CRI >80

**EAC** IP40  
IP55  
0,109 m³  
13,23 kg

INCLUDED:  
- LED / LED  
- Driver elettronico dimmerabile /  
Dimmable electronic driver

Lampadario a 20 luci. Rosone verniciato bianco, montatura in alluminio ramato lucido. Lampadario già cablato / 20 spots chandelier. White painted canopy, copper-plated aluminium structure. Already wired

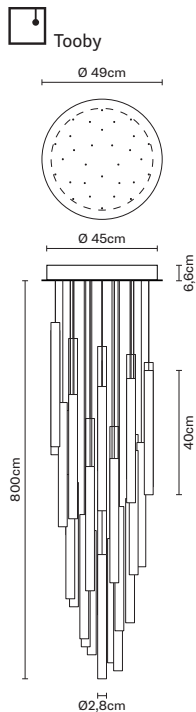

**F32 A05**  
00 Transparent

LED 220-240V  
30x2.1W-10°  
WHITE 2700K  
6000lm CRI >80

**EAC** IP40  
IP55  
0,157 m³  
19.545,00 kg

INCLUDED:  
- LED / LED  
- Driver elettronico dimmerabile /  
Dimmable electronic driver

Lampadario a 30 luci. Rosone verniciato bianco, montatura in alluminio anodizzato. Lampadario già cablato / 30 spots chandelier. White painted canopy, anodized aluminium structure. Already wired

**F32 A15**  
00 Transparent

LED 220-240V  
30x2.1W-10°  
WHITE 2700K  
6000lm CRI >80

**EAC** IP40  
IP55  
0,157 m³  
19.545,00 kg

INCLUDED:  
- LED / LED  
- Driver elettronico dimmerabile /  
Dimmable electronic driver

Lampadario a 30 luci. Rosone verniciato bianco, montatura in alluminio ramato lucido. Lampadario già cablato / 30 spots chandelier. White painted canopy, copper-plated aluminium structure. Already wired

**MULTISPOT TOOBY**

Nanne de Ru

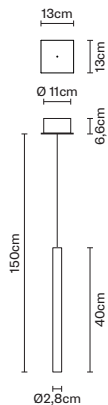

**code**

**electrification**

**technical info**

**accessories**

**F32 A06**  
00 Transparent

LED 220-240V  
1x2.1W-10°  
WHITE 2700K  
200lm Cri >80

**EAC** IP40  
IP55  
0,009 m<sup>3</sup>  
1.265,00 kg

INCLUDED:  
- LED / LED  
- Driver elettronico dimmerabile /  
Dimmable electronic driver



Lampadario a 1 luce. Rosone verniciato bianco, montatura in alluminio anodizzato. Lampadario già cablato / Single spot chandelier. White painted canopy, anodized aluminium structure. Already wired

**F32 A16**  
00 Transparent

LED 220-240V  
1x2.1W-10°  
WHITE 2700K  
200lm Cri >80

**EAC** IP40  
IP55  
0,009 m<sup>3</sup>  
1.265,00 kg

INCLUDED:  
- LED / LED  
- Driver elettronico dimmerabile /  
Dimmable electronic driver



Lampadario a 1 luce. Rosone verniciato bianco, montatura in alluminio ramato lucido. Lampadario già cablato / Single spot chandelier. White painted canopy, copper-plated aluminium structure. Already wired

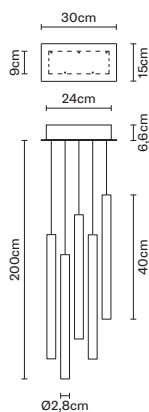

**F32 A07**  
00 Transparent

LED 220-240V  
5x2.1W-10°  
WHITE 2700K  
1000lm Cri >80

**EAC** IP40  
IP55  
0,029 m<sup>3</sup>  
4.005,00 kg

INCLUDED:  
- LED / LED  
- Driver elettronico dimmerabile /  
Dimmable electronic driver



Lampadario a 5 luci. Rosone verniciato bianco, montatura in alluminio anodizzato. Lampadario già cablato / 5 spots chandelier. White painted canopy, anodized aluminium structure. Already wired

**F32 A17**  
00 Transparent

LED 220-240V  
5x2.1W-10°  
WHITE 2700K  
1000lm Cri >80

**EAC** IP40  
IP55  
0,029 m<sup>3</sup>  
4.005,00 kg

INCLUDED:  
- LED / LED  
- Driver elettronico dimmerabile /  
Dimmable electronic driver



Lampadario a 5 luci. Rosone verniciato bianco, montatura in alluminio ramato lucido. Lampadario già cablato / 5 spots chandelier. White painted canopy, copper-plated aluminium structure. Already wired

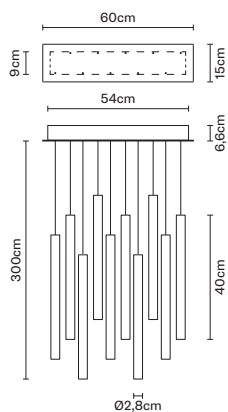

**F32 A08**  
00 Transparent

LED 220-240V  
10x2.1W-10°  
WHITE 2700K  
2000lm Cri >80

**EAC** IP40  
IP55  
0,073 m<sup>3</sup>  
8.105,00 kg

INCLUDED:  
- LED / LED  
- Driver elettronico dimmerabile /  
Dimmable electronic driver



Lampadario a 10 luci. Rosone verniciato bianco, montatura in alluminio anodizzato. Lampadario già cablato / 10 spots chandelier. White painted canopy, anodized aluminium structure. Already wired

**F32 A18**  
00 Transparent

LED 220-240V  
10x2.1W-10°  
WHITE 2700K  
2000lm Cri >80

**EAC** IP40  
IP55  
0,073 m<sup>3</sup>  
8.105,00 kg

INCLUDED:  
- LED / LED  
- Driver elettronico dimmerabile /  
Dimmable electronic driver



Lampadario a 10 luci. Rosone verniciato bianco, montatura in alluminio ramato lucido. Lampadario già cablato / 10 spots chandelier. White painted canopy, copper-plated aluminium structure. Already wired

**MULTISPOT TOOBY**

Nanne de Ru



Tooby

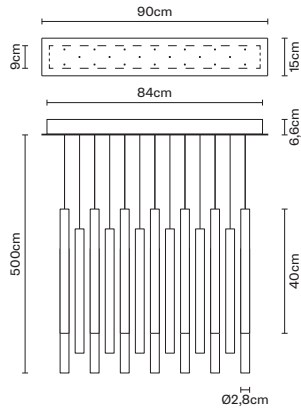

**code**

**electrification**

**technical info**

**accessories**

**F32 A09**  
00 Transparent

LED 220-240V  
20x2,1W-10°  
WHITE 2700K  
4000lm Cri >80

**EAC** IP40  
IP55  
0,143 m<sup>3</sup>  
14.075,00 kg

INCLUDED:  
- LED / LED  
- Driver elettronico dimmerabile /  
Dimmable electronic driver

Lampadario a 20 luci. Rosone verniciato bianco, montatura in alluminio anodizzato. Lampadario già cablato / 20 spots chandelier. White painted canopy, anodized aluminium structure. Already wired

**F32 A19**  
00 Transparent

LED 220-240V  
20x2,1W-10°  
WHITE 2700K  
4000lm Cri >80

**EAC** IP40  
IP55  
0,143 m<sup>3</sup>  
14.075,00 kg

INCLUDED:  
- LED / LED  
- Driver elettronico dimmerabile /  
Dimmable electronic driver

Lampadario a 20 luci. Rosone verniciato bianco, montatura in alluminio ramato lucido. Lampadario già cablato / 20 spots chandelier. White painted canopy, copper-plated aluminium structure. Already wired



Tooby

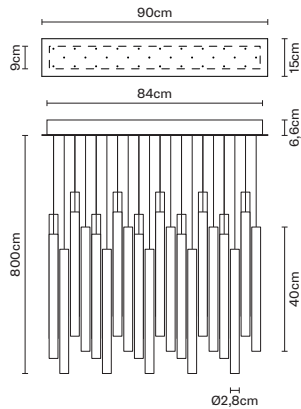

**F32 A10**  
00 Transparent

LED 220-240V  
30x2,1W-10°  
WHITE 2700K  
6000lm Cri >80

**EAC** IP40  
IP55  
0,182 m<sup>3</sup>  
13.345,00 kg

INCLUDED:  
- LED / LED  
- Driver elettronico dimmerabile /  
Dimmable electronic driver

Lampadario a 30 luci. Rosone verniciato bianco, montatura in alluminio anodizzato. Lampadario già cablato / 30 spots chandelier. White painted canopy, anodized aluminium structure. Already wired

**F32 A20**  
00 Transparent

LED 220-240V  
30x2,1W-10°  
WHITE 2700K  
6000lm Cri >80

**EAC** IP40  
IP55  
0,182 m<sup>3</sup>  
13.345,00 kg

INCLUDED:  
- LED / LED  
- Driver elettronico dimmerabile /  
Dimmable electronic driver

Lampadario a 30 luci. Rosone verniciato bianco, montatura in alluminio ramato lucido. Lampadario già cablato / 30 spots chandelier. White painted canopy, copper-plated aluminium structure. Already wired

# MULTISPOT POLAIR

La collezione Polair si compone di sospensioni per interno ed esterno. I rosoni, di forma e dimensioni diverse, sono in alluminio verniciato a polveri bianchi e possono essere forniti con le forature massime previste, oppure possono essere personalizzati su richiesta. I diffusori di Polair, forniti in 4 lunghezze di cavo elettrico, sono costituiti da elementi conici in vetro borosilicato (Pyrex®) sabbiato sul fondo e tappo in finitura verniciata nera opaca e ramata lucida. L'elettrificazione è a tensione di rete per LED.

La colección Polair está compuesta por lámparas colgantes de interior y exterior. Los rosetones, con formas y tamaños diferentes, son de aluminio pintado con polvos blancos y se pueden suministrar con los orificios máximos previstos o bien se personalizan bajo pedido. Los difusores de Polair, suministrados con un cable eléctrico en 4 medidas de largo, están constituidos por elementos cónicos de vidrio borosilicato (Pyrex®) arenado en el fondo y tapón con acabado pintado negro mate y cobrizo brillante. La electrificación es con tensión de red para Led.

Die Kollektion Polair besteht aus Hängelampen für Innenbereiche und Aussbereiche. Die Rosetten mit unterschiedlichen Formen und Abmessungen sind aus weiß pulverlackiertem Alu und können mit den vorgesehenen Höchstbohrungen geliefert oder nach Wunsch individuell gestaltet werden. Die Diffusoren von Polair, die in 4 Stromkabelängen geliefert werden, bestehen aus kegelförmigen Elementen aus Borsilicatglas (Pyrex®), die am Boden sandgestrahlt sind und einem mattschwarz und kupferpolierten Verschluss. Die Elektrifizierung erfolgt über Netzspannung bei LED-Lampen.

The Polair collection is made up of hanging lamps for indoor and outdoor use. The ceiling roses, in different shapes and sizes, are made in white painted aluminium and come either with the standard maximum number of holes, or customised on request. The Polair diffusers come in 4 electric cable lengths, and are composed of borosilicate (Pyrex®) glass cylindrical elements, with a sandblasted base, and have a cap with an opaque black and shiny copper finish. The lamp runs on mains power and is suitable for use with LED.

La collection Polair se compose de suspensions pour l'intérieur et l'extérieur. Les rosaces, de forme et de dimensions différentes, sont en aluminium peint par poudre blanche et peuvent être fournies avec les trous maximums prévus. Elles peuvent également être personnalisées. Les diffuseurs de Polair, proposés dans 4 longueurs de fil électrique différentes, se composent d'éléments coniques en verre de borosilicate (Pyrex®) sablé sur le fond et d'une couverture de finition peinte en noir opaque ou cuivre brillant. Les LED sont alimentées par la tension du réseau.

Линейка Polair представляет подвесные светильники для внутреннего освещения помещений и внешний. Розетки, выполненные из алюминия с белым порошковым покрытием, поражают богатством своих форм и размеров. Розетки могут поставляться с максимальным количеством отверстий или же изготавливаться по индивидуальному заказу. Световые рассеиватели Polair оборудованы кабелем разной длины (4 размера) и включают в себя конические элементы из боросиликатного стекла (Pyrex®) с пескоструйной обработкой внутри и колпачок с матовой черной и глянцевой медной отделкой. Электрическая часть рассчитана на светодиодные лампы от сети напряжения.







**MULTISPOT POLAIR**

Flynn Talbot

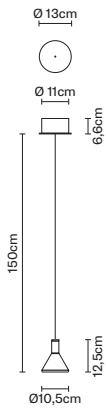

**code**      **electrification**      **technical info**      **accessories**

**F32 A41**  
00 Transparent

LED 220-240V  
1x2.1W-10°  
WHITE 2700K  
200lm Cri >80

**EAC** IP40  
IP55  
0,009 m<sup>3</sup>  
1,02 kg

INCLUDED:  
- LED / LED  
- Driver elettronico dimmerabile /  
Dimmable electronic driver



Lampadario a 1 luce. Rosone verniciato bianco, montatura in alluminio anodizzato nero. Lampadario già cablato / *Single spot chandelier. White painted canopy, black anodized aluminium structure. Already wired*

**F32 A51**  
00 Transparent

LED 220-240V  
1x2.1W-10°  
WHITE 2700K  
200lm Cri >80

**EAC** IP40  
IP55  
0,009 m<sup>3</sup>  
1,02 kg

INCLUDED:  
- LED / LED  
- Driver elettronico dimmerabile /  
Dimmable electronic driver



Lampadario a 1 luce. Rosone verniciato bianco, montatura in alluminio ramato lucido. Lampadario già cablato / *Single spot chandelier. White painted canopy, copper-plated aluminium structure. Already wired*

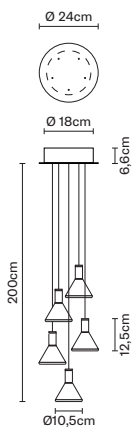

**F32 A42**  
00 Transparent

LED 220-240V  
5x2.1W-10°  
WHITE 2700K  
1000lm Cri >80

**EAC** IP40  
IP55  
0,03 m<sup>3</sup>  
3.375,00 kg

INCLUDED:  
- LED / LED  
- Driver elettronico dimmerabile /  
Dimmable electronic driver



Lampadario a 5 luci. Rosone verniciato bianco, montatura in alluminio anodizzato nero. Lampadario già cablato / *5 spots chandelier. White painted canopy, black anodized aluminium structure. Already wired*

**F32 A52**  
00 Transparent

LED 220-240V  
5x2.1W-10°  
WHITE 2700K  
1000lm Cri >80

**EAC** IP40  
IP55  
0,03 m<sup>3</sup>  
3.375,00 kg

INCLUDED:  
- LED / LED  
- Driver elettronico dimmerabile /  
Dimmable electronic driver



Lampadario a 5 luci. Rosone verniciato bianco, montatura in alluminio ramato lucido. Lampadario già cablato / *5 spots chandelier. White painted canopy, copper-plated aluminium structure. Already wired*

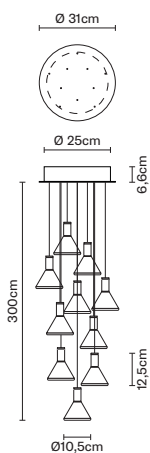

**F32 A43**  
00 Transparent

LED 220-240V  
10x2.1W-10°  
WHITE 2700K  
2000lm Cri >80

**EAC** IP40  
IP55  
0,062 m<sup>3</sup>  
6.055,00 kg

INCLUDED:  
- LED / LED  
- Driver elettronico dimmerabile /  
Dimmable electronic driver



Lampadario a 10 luci. Rosone verniciato bianco, montatura in alluminio anodizzato nero. Lampadario già cablato / *10 spots chandelier. White painted canopy, black anodized aluminium structure. Already wired*

**F32 A53**  
00 Transparent

LED 220-240V  
10x2.1W-10°  
WHITE 2700K  
2000lm Cri >80

**EAC** IP40  
IP55  
0,062 m<sup>3</sup>  
6.055,00 kg

INCLUDED:  
- LED / LED  
- Driver elettronico dimmerabile /  
Dimmable electronic driver



Lampadario a 10 luci. Rosone verniciato bianco, montatura in alluminio ramato lucido. Lampadario già cablato / *10 spots chandelier. White painted canopy, copper-plated aluminium structure. Already wired*

**MULTISPOT POLAIR**

Flynn Talbot

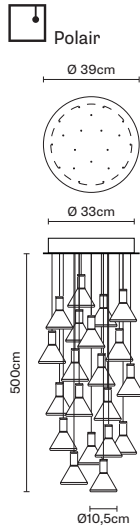

*code*

*electrification*

*technical info*

*accessories*

**F32 A44**  
00 Transparent

LED 220-240V  
20x2.1W-10°  
WHITE 2700K  
4000lm CRI >80

**EAC** IP40  
IP55  
0,121 m³  
10,97 kg

INCLUDED:  
- LED / LED  
- Driver elettronico dimmerabile /  
Dimmable electronic driver

Lampadario a 20 luci. Rosone verniciato bianco, montatura in alluminio anodizzato nero. Lampadario già cablato / 20 spots chandelier. White painted canopy, black anodized aluminium structure. Already wired

**F32 A54**  
00 Transparent

LED 220-240V  
20x2.1W-10°  
WHITE 2700K  
4000lm CRI >80

**EAC** IP40  
IP55  
0,121 m³  
10,97 kg

INCLUDED:  
- LED / LED  
- Driver elettronico dimmerabile /  
Dimmable electronic driver

Lampadario a 20 luci. Rosone verniciato bianco, montatura in alluminio ramato lucido. Lampadario già cablato / 20 spots chandelier. White painted canopy, copper-plated aluminium structure. Already wired

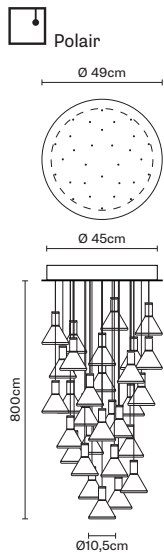

**F32 A45**  
00 Transparent

LED 220-240V  
30x2.1W-10°  
WHITE 2700K  
6000lm CRI >80

**EAC** IP40  
IP55  
0,175 m³  
16.155,00 kg

INCLUDED:  
- LED / LED  
- Driver elettronico dimmerabile /  
Dimmable electronic driver

Lampadario a 30 luci. Rosone verniciato bianco, montatura in alluminio anodizzato nero. Lampadario già cablato / 30 spots chandelier. White painted canopy, black anodized aluminium structure. Already wired

**F32 A55**  
00 Transparent

LED 220-240V  
30x2.1W-10°  
WHITE 2700K  
6000lm CRI >80

**EAC** IP40  
IP55  
0,175 m³  
16.155,00 kg

INCLUDED:  
- LED / LED  
- Driver elettronico dimmerabile /  
Dimmable electronic driver

Lampadario a 30 luci. Rosone verniciato bianco, montatura in alluminio ramato lucido. Lampadario già cablato / 30 spots chandelier. White painted canopy, copper-plated aluminium structure. Already wired

## MULTISPOT POLAIR

Flynn Talbot

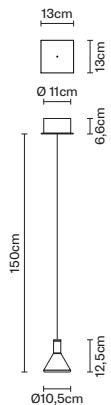
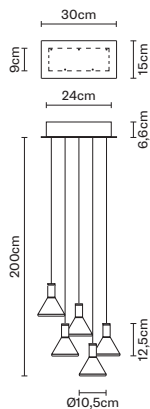
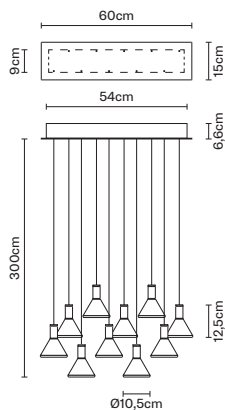
**code****electrification****technical info****accessories****F32 A46**  
00 TransparentLED 220-240V  
1x2.1W-10°  
WHITE 2700K  
200lm Cri >80**EAC** IP40  
IP55  
0,009 m<sup>3</sup>  
1,16 kgINCLUDED:  
- LED / LED  
- Driver elettronico dimmerabile /  
Dimmable electronic driverLampadario a 1 luce. Rosone verniciato bianco, montatura in alluminio anodizzato nero. Lampadario già cablato / *Single spot chandelier. White painted canopy, black anodized aluminium structure. Already wired***F32 A56**  
00 TransparentLED 220-240V  
1x2.1W-10°  
WHITE 2700K  
200lm Cri >80**EAC** IP40  
IP55  
0,009 m<sup>3</sup>  
1,16 kgINCLUDED:  
- LED / LED  
- Driver elettronico dimmerabile /  
Dimmable electronic driverLampadario a 1 luce. Rosone verniciato bianco, montatura in alluminio ramato lucido. Lampadario già cablato / *Single spot chandelier. White painted canopy, copper-plated aluminium structure. Already wired***F32 A47**  
00 TransparentLED 220-240V  
5x2.1W-10°  
WHITE 2700K  
1000lm Cri >80**EAC** IP40  
IP55  
0,031 m<sup>3</sup>  
3,44 kgINCLUDED:  
- LED / LED  
- Driver elettronico dimmerabile /  
Dimmable electronic driverLampadario a 5 luci. Rosone verniciato bianco, montatura in alluminio anodizzato nero. Lampadario già cablato / *5 spots chandelier. White painted canopy, black anodized aluminium structure. Already wired***F32 A57**  
00 TransparentLED 220-240V  
5x2.1W-10°  
WHITE 2700K  
1000lm Cri >80**EAC** IP40  
IP55  
0,031 m<sup>3</sup>  
3,44 kgINCLUDED:  
- LED / LED  
- Driver elettronico dimmerabile /  
Dimmable electronic driverLampadario a 5 luci. Rosone verniciato bianco, montatura in alluminio ramato lucido. Lampadario già cablato / *5 spots chandelier. White painted canopy, copper-plated aluminium structure. Already wired***F32 A48**  
00 TransparentLED 220-240V  
10x2.1W-10°  
WHITE 2700K  
2000lm Cri >80**EAC** IP40  
IP55  
0,077 m<sup>3</sup>  
6.975,00 kgINCLUDED:  
- LED / LED  
- Driver elettronico dimmerabile /  
Dimmable electronic driverLampadario a 10 luci. Rosone verniciato bianco, montatura in alluminio anodizzato nero. Lampadario già cablato / *10 spots chandelier. White painted canopy, black anodized aluminium structure. Already wired***F32 A58**  
00 TransparentLED 220-240V  
10x2.1W-10°  
WHITE 2700K  
2000lm Cri >80**EAC** IP40  
IP55  
0,077 m<sup>3</sup>  
6.975,00 kgINCLUDED:  
- LED / LED  
- Driver elettronico dimmerabile /  
Dimmable electronic driverLampadario a 10 luci. Rosone verniciato bianco, montatura in alluminio ramato lucido. Lampadario già cablato / *10 spots chandelier. White painted canopy, copper-plated aluminium structure. Already wired*

**MULTISPOT POLAIR**

Flynn Talbot



Polair

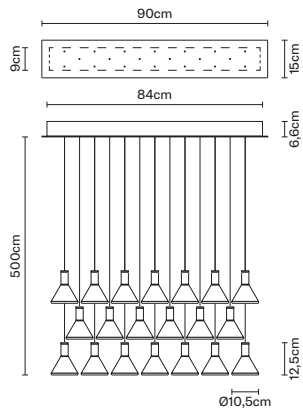

**code**

**electrification**

**technical info**

**accessories**

**F32 A49**  
00 Transparent

LED 220-240V  
20x2,1W-10°  
WHITE 2700K  
4000lm Cri >80

**EAC** IP40  
IP55  
0,151 m<sup>3</sup>  
11.815,00 kg

INCLUDED:  
- LED / LED  
- Driver elettronico dimmerabile /  
Dimmable electronic driver

Lampadario a 20 luci. Rosone verniciato bianco, montatura in alluminio anodizzato nero. Lampadario già cablato / 20 spots chandelier. White painted canopy, black anodized aluminium structure. Already wired

**F32 A59**  
00 Transparent

LED 220-240V  
20x2,1W-10°  
WHITE 2700K  
4000lm Cri >80

**EAC** IP40  
IP55  
0,151 m<sup>3</sup>  
11.815,00 kg

INCLUDED:  
- LED / LED  
- Driver elettronico dimmerabile /  
Dimmable electronic driver

Lampadario a 20 luci. Rosone verniciato bianco, montatura in alluminio ramato lucido. Lampadario già cablato / 20 spots chandelier. White painted canopy, copper-plated aluminium structure. Already wired



Polair

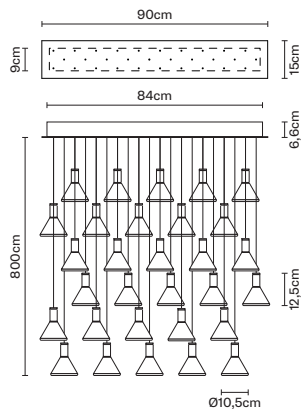

**F32 A50**  
00 Transparent

LED 220-240V  
30x2,1W-10°  
WHITE 2700K  
6000lm Cri >80

**EAC** IP40  
IP55  
0,194 m<sup>3</sup>  
14.995,00 kg

INCLUDED:  
- LED / LED  
- Driver elettronico dimmerabile /  
Dimmable electronic driver

Lampadario a 30 luci. Rosone verniciato bianco, montatura in alluminio anodizzato nero. Lampadario già cablato / 30 spots chandelier. White painted canopy, black anodized aluminium structure. Already wired

**F32 A60**  
00 Transparent

LED 220-240V  
30x2,1W-10°  
WHITE 2700K  
6000lm Cri >80

**EAC** IP40  
IP55  
0,194 m<sup>3</sup>  
14.995,00 kg

INCLUDED:  
- LED / LED  
- Driver elettronico dimmerabile /  
Dimmable electronic driver

Lampadario a 30 luci. Rosone verniciato bianco, montatura in alluminio ramato lucido. Lampadario già cablato / 30 spots chandelier. White painted canopy, copper-plated aluminium structure. Already wired

# OLYMPIC

—

Lorenzo Truant









# CONCEPT

---

Un anello di luce ha il fascino olimpico di una forma aerea e conchiusa, a sé bastante. Un singolo anello permette di illuminare gli spazi proiettando la sua luce nello spazio come se agisse una forza centrifuga. Ma quando due o più anelli di luce si concatenano tra loro si forma una interdipendenza tra gli elementi luminosi che permette di creare una gerarchia di luci la quale rende lo spazio intellegibile. In questa grammatica della luce fatta di monosillabi circolari si possono creare olimpiche frasi negli ampi spazi del contemporaneo.

A self-contained light ring with an aerial shape, inspired by the Olympic rings. A single ring can illuminate the environment by projecting its light as if moved by centrifugal force. When one or more light rings are connected to one another, the luminous sources interconnect creating a hierarchy of lights that clarifies the space. This light structure comprising circular blocks creates Olympic constructions in large contemporary spaces.

Un anillo de luz con la fascinación olímpica de una forma aérea y cerrada, suficiente a sí mismo. Un solo anillo permite iluminar los espacios proyectando su luz en el espacio como si fuese una fuerza centrífuga. Aunque cuando dos o más anillos de luz se concatenan entre sí se forma una interdependencia entre los elementos luminosos, que permite crear una jerarquía de luces para que el espacio resulte inteligible. En esta gramática de la luz a base de monosílabas circulares, se pueden crear frases olímpicas en los amplios espacios del mundo contemporáneo.

Der Lichtring zeigt den olympischen Zauber einer luftigen und vollkommenen, unaufdringlichen Form. Ein einzelner Ring kann ein Ambiente beleuchten, indem er sein Licht wie durch Schwingkraft getrieben in den Raum projiziert. Sobald aber zwei oder mehrere Lichtringe kombiniert werden, bildet sich eine Wechselbeziehung zwischen den Leuchtkörpern, die in eine Rangfolge gebracht werden können, um den Raum erfassbar zu machen. Diese lichtvollen, kreisförmigen Elemente formen in großzügigen Wohnbereichen olympisch anmutende Strukturen, die zeitgemäßen Visionen gleichen.

Un anneau de lumière qui dégage un charme olympique grâce à sa forme aérienne et aboutie qui se suffit à elle-même. Un seul anneau permet d'éclairer les pièces en projetant sa lumière dans l'espace comme s'il s'agissait d'une force centrifuge, mais lorsque deux ou plusieurs anneaux de lumières s'enchaînent entre eux, il se crée une sorte d'interdépendance entre les éléments lumineux qui permet de former une hiérarchie de lumières rendant l'espace intelligible. Cette grammaire de la lumière, faite de monosyllabes circulaires, permet de créer des phrases à connotation olympique dans les vastes espaces de vie contemporains.

Светящееся кольцо воздушной овальной формы напоминает олимпийское кольцо, и уже само по себе является идеальной формой. Одно кольцо позволяет освещать пространства, распределяя свет якобы с центробежной силой. Но когда два или более световых кольца соединяются между собой, они создают взаимозависимость между светящимися элементами, иерархию света, разделяющую пространство на круговые олимпийские элементы.

# OLYMPIC

---

Olympic è una collezione di sospensioni circolari in alluminio verniciato bianco con la sorgente luminosa a LED collocata sulla circonferenza esterna. L'emissione della luce è pertanto sia diretta che indiretta. Le sospensioni sono disponibili in diversi diametri, sia singolarmente che in gruppi multipli. La particolarità di queste lampade è data dalla possibilità di intersecarle tra loro, creando forme e composizioni originali, grazie anche alla facilità di regolazione delle lunghezze dei cavi.

Olympic is a round white painted aluminium hanging light collection, with the LED light source located on the outer ring. Both direct and indirect light diffusion. The hanging lights are available in different diameters, and in single or multiple layouts. The peculiarity of these lamps is the possibility to intertwine them, creating original shapes and compositions, also thanks to the easy cable length adjustment.

Olympic ist eine Kollektion mit ringförmigen Hängelampen aus weiß lackiertem Aluminium, deren LED-Leuchten auf dem äußeren Kreisumfang angebracht sind. Die Beleuchtung ist deshalb sowohl direkt als auch indirekt. Die Hängelampen sind mit unterschiedlichem Durchmesser einzeln oder als Set mit mehreren Leuchten erhältlich. Das Besondere dieser Lampen ist, dass sie dank der einfachen Regulierbarkeit ihrer Kabel die verschiedensten Gestaltungsmöglichkeiten und originelle Kompositionen ermöglichen.

Olympic is a round white painted aluminium hanging light collection, with the LED light source located on the outer ring. Both direct and indirect light diffusion. The hanging lights are available in different diameters, and in single or multiple layouts. The peculiarity of these lamps is the possibility to intertwine them, creating original shapes and compositions, also thanks to the easy cable length adjustment.

Olympic est une collection de suspensions circulaires en aluminium verni blanc avec source lumineuse à LED. L'émission de la lumière est directe et indirecte. Les suspensions sont disponibles en divers diamètres, que ce soit individuellement ou en groupes multiples. La particularité de ces lampes réside dans le fait qu'il est possible de les croiser entre elles, en créant des formes et des compositions originales, grâce à la simplicité de réglage de la longueur des câbles.

Olympic – это коллекция кругообразных подвесок из белого алюминия со светодиодным световым источником, расположенном на внешней окружности. Рассеивание света прямое и косвенное. Подвески имеются в наличии в различных диаметрах, как по отдельности, так и в группах. Особенность этих ламп – это возможность пересекать их между собой, создавая оригинальные формы и композиции, благодаря возможности регулировать длину кабеля.



**OLYMPIC**  
Lorenzo Truant

code

electrification

technical info

accessories

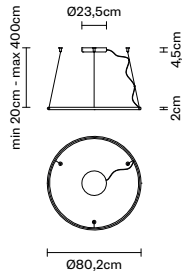

**NEW!** **F45 A01**  
01 White

LED 220-240V  
1x56W-120°  
WHITE 3000K  
6000lm Cri 80

**EAC** IP40

INCLUDED:  
- LED / LED  
- Alimentatore elettronico dimmerabile /  
Dimmable electronic driver

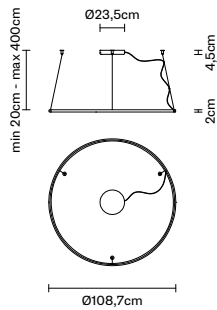

**NEW!** **F45 A03**  
01 White

LED 220-240V  
1x76W-120°  
WHITE 3000K  
8250lm Cri 80

**EAC** IP40

INCLUDED:  
- LED / LED  
- Alimentatore elettronico dimmerabile /  
Dimmable electronic driver

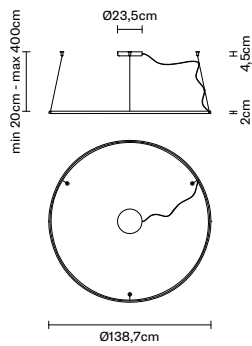

**NEW!** **F45 A05**  
01 White

LED 220-240V  
1x98W-120°  
WHITE 3000K  
10600lm Cri 80

**EAC** IP40

INCLUDED:  
- LED / LED  
- Alimentatore elettronico dimmerabile /  
Dimmable electronic driver

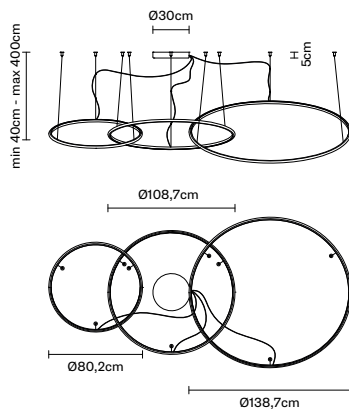

**NEW!** **F45 A11**  
01 White

LED 220-240V  
1x56W-120°  
1x76W-120°  
1x98W-120°  
WHITE 3000K  
24850lm Cri 80

**EAC** IP40

INCLUDED:  
- LED / LED  
- Alimentatore elettronico dimmerabile /  
Dimmable electronic driver



Composizione con le tre sospensioni / Combination of three pendants

# ORU

—

Vim & Vigor







# CONCEPT

---

Per questo progetto i designers Vim&Vigor si sono lasciati ispirare dal grande potenziale che sta alla base del mondo degli origami e così raccontano: “C’è qualcosa di magico nel trasformare un foglio di carta piatto, dandogli una forma completamente diversa, bella. Dopo giorni dedicati al tradizionale brainstorming e alla creazione del concept, alla ricerca di nuovi spunti e idee, ci siamo imbattuti nell’immagine di un vascello con gli angoli ripiegati, e abbiamo pensato: non sarebbe interessante unire la tecnica del taglio e della piegatura ad una forma tradizionale di metallo tornito?. Abbiamo capito immediatamente che avevamo imboccato la strada giusta”.

For this project, designers Vim&Vigor drew inspiration from the great potential of the art of origami, as they themselves tell: “There is something quite magical in taking an ordinary flat sheet of paper and forming it into something completely different and beautiful. After many days of traditional brainstorming and concepting, looking for new inspirations and ideas, we came across the image of a vessel with folded corners. We thought “Wouldn’t it be really interesting to combine the cutting/folding technique with a traditional spun metal shape? We understood immediately that we had taken the right direction”.

Para este proyecto los diseñadores Vim& Vigor se han dejado inspirar por el gran potencial que reside en la base del mundo de los origami y así nos lo cuentan “Hay algo mágico en la transformación de una hoja de papel plana al darle una forma completamente distinta y bonita. Después de días dedicados a la sesión tradicional de creatividad y a la creación del concepto, buscando nuevas inspiraciones e ideas, vimos la foto de un navío con los ángulos plegados y pensamos: “¿Tal vez, podría ser interesante unir la técnica del corte y la del plegado con una forma de metal tradicional torneado? Entendimos inmediatamente que éste era el camino a seguir.

Für dieses Projekt haben sich die Designer Vim& Vigor von dem großen Potential inspirieren lassen, das der Origami-Welt zugrunde liegt, und erzählen: „Es ist bezaubernd, wie ein flaches Stück Papier umgewandelt werden kann und eine komplett andere und schöne Form erhält. Nach Tagen unserer herkömmlichen Ideensammlung und der Entwicklung des Konzepts, auf der Suche nach neuen Intuitionen und Ideen, haben wir ein Bild eines Schiffs mit umgebogenen Ecken gesehen und gedacht: Wäre es nicht interessant, die Technik des Schnitts und des Biegens mit einer traditionellen Form gedrehten Metalls zu verbinden? Wir haben sofort verstanden, dass wir den richtigen Weg eingeschlagen hatten“.

Pour ce projet, les designers Vim& Vigor se sont inspirés du grand potentiel du monde des origamis et nous racontent: “Il y a quelque chose de vraiment magique dans la transformation d’une feuille de papier plat, en lui donnant une forme complètement différente et belle. Après quelques jours consacrés au brainstorming traditionnel et à la création du concept, à la recherche de nouvelles idées, nous sommes tombés sur l’image d’un vaisseau avec les coins repliés et nous nous sommes dit: ne serait-il pas intéressant d’unir la technique de la découpe et du pliage à une forme traditionnelle de métal tourné ? Nous avons immédiatement compris que nous étions sur la bonne voie”.

Работая над этим проектом, дизайнеры Vim & Vigor вдохновились огромным потенциалом, стоящим в основе мира оригами. «Есть что-то волшебное в трансформации плоского листа бумаги, в придавании ему совершенно другой, красивой формы. По истечении нескольких дней традиционного мозгового штурма для создания концепции и поиска новых идей, мы наткнулись на изображение корабля с загнутыми углами и подумали: наверное было бы интересно соединить вместе технику резки и гнутья с традиционной формой тонкого листового металла?» Мы мгновенно поняли что выбрали правильный путь.

# ORU

---

La collezione Oru si costituisce di due tipologie di sospensioni per interno. La prima, con la forma asimmetrica ed il particolare foro, è in metallo piegato, verniciato esternamente in nero ed internamente in rosso, verde e blu petrolio. La seconda, elegante e pregiata, è una calotta semisferica in rame, un pezzo unico, brunito esternamente e lucido internamente. L'elettrificazione è a tensione di rete per lampade alogene, fluorescenti e LED.

La colección Oru está compuesta por dos tipos de lámparas colgantes de interior. La primera, con la forma asimétrica y el orificio especial es de metal plegado, pintada externamente de color negro e internamente de rojo, verde y azul petróleo. La segunda, elegante y valiosa, es un cuerpo semiesférico de cobre, una pieza única, bruñida por fuera y brillante por dentro. La electrificación es con tensión de red para bombillas halógenas, fluorescentes y LED.

Die Kollektion Oru besteht aus zwei Hängelampenarten für Innenbereiche. Die erste mit einer asymmetrischen Form und einer besonderen Bohrung, aus gebogenem Metall, außen schwarz und innen rot, grün und petrolblau lackiert. Die zweite, elegant und wertvoll, stellt eine Kupferhalbkugel dar, ein einziges Teil, extern brüniert und intern poliert. Die Elektrifizierung erfolgt über Netzspannung bei Halogen-, Fluoreszenz- und LED-Lampen.

The Oru collection is made up of two types of hanging lamp for indoor use. The first, with an asymmetric shape and a particular hole, is in folded metal, painted in black on the outside and red, green and petroleum blue on the inside. The second, with its elegant, exquisite design, is a semi-spherical shade in copper, made in a single piece, burnished on the outside and polished on the inside. The lamp runs on mains power and is suitable for use with halogen, fluorescent and LED bulbs.

La collection Oru est constituée par deux typologies de suspensions pour intérieur. La première, de forme asymétrique avec son trou particulier, est en métal plié, verni en noir à l'extérieur et, à l'intérieur, en rouge, vert et bleu pétrole. La seconde, élégante et précieuse, est une calotte semi-sphérique en cuivre, une pièce unique, brunie à l'extérieur et brillante à l'intérieur. Les lampes halogènes, les ampoules fluorescentes et LED sont alimentées par la tension du réseau.

Коллекция Oru состоит из двух видов подвесных светильников для внутренних помещений. Первая подвеска ассиметричной формы с необычным отверстием из ценного металла окрашена снаружи в черный цвет, а внутри - в красный, зеленый или сине-нефтяной цвет. Вторая подвеска - это изысканная, уникальная и дорогая полусфера из меди, полированная снаружи и глянцевая внутри. Электрическая часть рассчитана на галогеновую, люминесцентную и светодиодную лампу от сетевого напряжения.





**ORU**

Vim & Vigor

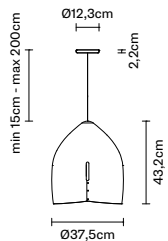

**code**

**electrification**

**technical info**

**accessories**

**F25 A01**  
**03 Red**  
**43 Green**  
**73 Teal blue**

E27 220-240V  
 1x150W HSGST



**EAC IP20**  
 0,133 m<sup>3</sup>  
 3,77 kg

NOT INCLUDED:  
 - Lampadina / Bulb

E27 220-240V  
 1x23W FBC

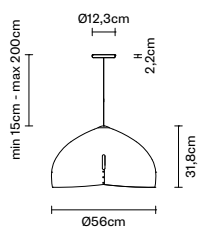

**F25 A03**  
**03 Red**  
**43 Green**  
**73 Teal blue**

E27 220-240V  
 1x150W HSGST



**EAC IP20**  
 0,144 m<sup>3</sup>  
 4,81 kg

NOT INCLUDED:  
 - Lampadina / Bulb

E27 220-240V  
 1x23W FBC

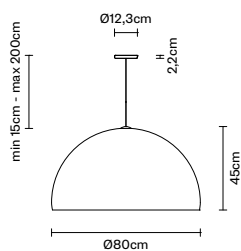

**F25 A07**  
**41 Copper**

E27 220-240V  
 3x150W HSGST



**EAC IP20**  
 0,317 m<sup>3</sup>  
 12,10 kg

NOT INCLUDED:  
 - Lampadina / Bulb

E27 220-240V  
 3x23W FBC



# POLAIR

—

Flynn Talbot



## CONCEPT

---

Progettata per dare una presenza fisica ai raggi invisibili, Polair cattura la magia della luce. Il vetro traccia la forma del fascio creando una qualità di luce molto morbida e delicata, ottima per donare la giusta atmosfera all'ambiente. L'angolo della luce è perfettamente modellato per incontrare il diffusore in cui vengono controllati i riflessi ed enfatizzate le fluttuanti sensazioni che la stessa lampada ricrea. Polair è una lampada a sospensione trasparente con un elegante dettaglio in vetro sabbiato, ideale per impreziosire gli ambienti interni sia privati che pubblici.

Polair captures the light's magic and was created with the intention of providing an almost physical presence to its invisible rays. The glass traces the shape of the beam, creating an extremely soft and delicate lighting quality, excellent for giving the right atmosphere to a room. The lighting angle is perfectly designed to meet the diffuser which then emphasizes the reflections, creating fluctuating emotions. Polair is a transparent pendant lamp with elegant detailing in sandblasted glass, ideal for enhancing any indoor living area, in the home or workplace.

Polair, diseñada para materializar los rayos invisibles, captura la magia de la luz. El vidrio dibuja la forma del haz y crea una calidad de luz muy suave y delicada, óptima para regalar la atmósfera adecuada al ambiente. El ángulo de la luz se modela perfectamente para llegar al difusor donde se controlan los reflejos y se enfatizan las sensaciones fluctuaciones que la misma lámpara recrea. Polair es una lámpara colgante transparente con un elemento elegante de vidrio arenado; es ideal para embellecer los ambientes internos de carácter privado y público.

Um den unsichtbaren Strahlen eine physische Präsenz zu verleihen, fängt Polair den Zauber des Lichts ein. Das Glas zeichnet die Form des Lichtbündels und erzeugt eine sehr weiche und sanfte Lichtqualität, die dem Ambiente die richtige Atmosphäre verleiht. Der Lichtwinkel ist perfekt modelliert, um den Diffusor anzutreffen, in dem die Reflexe kontrolliert und die schwimmenden Empfindungen betont werden, die die Lampe wiedergibt. Polair ist eine transparente Hängelampe mit einem eleganten Detail aus sandgestrahltem Glas, ideal für interne private und öffentliche Umgebungen.

Polair capture la magie de la lumière. Elle a été conçue pour offrir une présence physique aux rayons invisibles. Le verre trace la forme du faisceau en créant ainsi une qualité de lumière très douce et délicate, parfaite pour donner la juste atmosphère à l'environnement. L'angle de lumière est parfaitement modelé pour rencontrer le diffuseur où sont contrôlés les reflets et où les sensations fluctuantes que la lampe recrée sont mis en valeur. Polair est une lampe suspension transparente avec un détail en verre sablé original. Elle est idéale pour la décoration des intérieurs privés ou publics.

Эта коллекция светильников призвана подарить физическое ощущение невидимых лучей света. В линейке Polair воплотилась вся магия света. Стекло прослеживает форму луча, тем самым создавая мягкое и нежное освещение для воспроизведения неповторимой атмосферы помещения. Угол света, встречаясь с рассеивателем, распадается на четкие блики, придавая в то же время колебание ощущений атмосферы. Polair - это подвесной прозрачный светильник с элегантною деталью из пескоструйного стекла. Светильники этой линейки идеальны для украшения и внутренних помещений жилых домов, и общественных заведений.

# POLAIR

La collezione Polair si compone da una sospensione disponibile in una sola dimensione per interno. Il diffusore è in vetro borosilicato (Pyrex®) sabbiato sul fondo. Polair è disponibile con struttura in finitura verniciata nera opaca e ramata lucido. L'elettificazione è a tensione di rete per LED con alimentatore dimmerabile integrato.

La colección Polair está compuesta por una lámpara colgante disponible en único tamaño para interior. El difusor es de vidrio borosilicato (Pyrex®) arenado en el fondo. Polair existe con estructura con acabado pintado negro mate y cobrizo brillante. La electrificación es con tensión de red para Led con un alimentador electrónico con intensidad de la luz regulable.

Die Kollektion Polair besteht aus einer Hängelampe in nur einer Abmessung für Innenbereiche. Der Diffusor besteht aus Borsilicatglas (Pyrex®), der am Boden sandgestrahlt ist. Polair ist auch mit einer mattschwarz lackierten und kupferpolierten Struktur erhältlich. Die Elektrifizierung erfolgt über Netzspannung für LED mit integriertem, dimmerbarem Netzteil.

The Polair collection consists of an indoor pendant lamp available in one size only. The diffuser is in borosilicate glass (Pyrex) with a sandblasted base. Polair is available in an opaque black and shiny copper finish. The energy voltage is LED with a incorporated dimmer switch.

La collection Polair se compose d'une suspension proposée en une seule dimension pour l'intérieur. Le diffuseur est en verre de borosilicate (Pyrex®) sablé sur le fond. Polair est proposée avec une structure peinte en noir opaque ou cuivré brillant. L'électrification est à tension de réseau pour ampoules à LED et ballast à intensité variable intégré.

Коллекцию Polair представляет одноразмерная подвесная люстра для внутреннего освещения помещений. Рассеиватель выполнен из боросиликатного стекла (Pyrex®) с пескоструйной обработкой внутри. Люстры Polair могут иметь матовую черную или глянцевую медную отделку. Цоколь предназначен для светодиода (LED) со встроенным блоком питания с регулятором яркости.



**POLAIR**  
Flynn Talbot

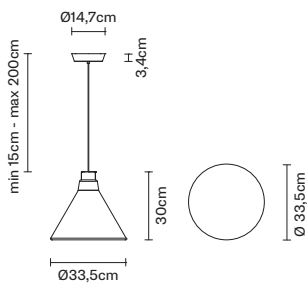

**code**

**electrification**

**technical info**

**accessories**

**F36 A01**  
**00 Transparent**

LED 220-240V  
1x14W-40°  
WHITE 3000K  
1200lm CRI >80



**EAC** IP20

0,075 m<sup>3</sup>  
3,52 kg



**INCLUDED:**

- LED / LED
- Alimentatore elettronico dimmerabile / Dimmable electronic driver

Struttura in alluminio verniciato nero / Black painted aluminium structure

**F36 A03**  
**00 Transparent**

LED 220-240V  
1x14W-40°  
WHITE 3000K  
1200lm CRI >80



**EAC** IP20

0,075 m<sup>3</sup>  
3,52 kg



**INCLUDED:**

- LED / LED
- Alimentatore elettronico dimmerabile / Dimmable electronic driver

Struttura in alluminio ramato lucido / Copper-plated aluminium structure



# ROOFER

—

Benjamin Hubert









## CONCEPT

---

Giovane è il primo aggettivo per descrivere questa collezione di sospensioni, disegnate da Benjamin Hubert, che per la forma dei singoli elementi, ha preso spunto dalle tegole in laterizio dei tetti delle abitazioni.

Divertente è il secondo aggettivo perché, partendo dalla nuda struttura in metallo, Roofer dà la possibilità di costruirla facendola diventare il motivo per un gioco collettivo. Moderna è il terzo aggettivo perché le scaglie, costituite da un materiale gommoso semirigido, possono essere lavate in lavatrice a 30°.

Youthful is the most appropriate adjective to describe this collection of hanging lamps designed by Benjamin Hubert, who drew inspiration from roof tiles to create the shape of the single elements.

Fun is the second adjective: Roofer, in fact, can be assembled, making it a sort of group game. Modern is the third adjective because the scales, made in a semi-rigid rubbery material, can be machine-washed at 30°.

Joven es el primer adjetivo para describir esta colección de lámparas colgantes, diseñadas por Benjamin Hubert, que se ha inspirado en las tejas de ladrillo de los tejados de las casas para dar una forma a los elementos individuales. Divertido es el segundo adjetivo porque, a partir de una estructura desnuda de metal, Roofer permite construirla para convertirla en el motivo para un juego colectivo. Moderna es el tercer adjetivo porque las escamas, constituidas por un material de goma semirígido, pueden lavarse en la lavadora a 30°.

Jung ist das erste Adjektiv zur Beschreibung dieser Hängelampenkollektion von Benjamin Hubert, der für die Form der einzelnen Elemente Dachziegel als Ausgangspunkt genommen hat.

Unterhaltsam ist das zweite Adjektiv, da Roofer von der bloßen Metallstruktur ausgehend die Möglichkeit gibt, sie zu bilden und zu einem Motiv für ein kollektives Spiel zu machen. Modern ist das dritte Adjektiv, da die aus einem gummiartigen halbstarreren Material gefertigten Splitter in der Waschmaschine bei 30° gewaschen werden können.

“Jeune” est le premier adjectif qui vient à l’esprit pour décrire cette collection de suspensions dessinées par Benjamin Hubert dont la forme de chaque élément rappelle les tuiles en terre cuite des toitures des maisons.

“Divertissante” est le second adjectif car, au départ de la structure de base en métal, Roofer offre la possibilité de la construire en la faisant devenir le thème d’un jeu collectif. “Moderne” est le troisième adjectif, car les écailles constituées par un matériau caoutchouteux semi-rigide, peuvent être lavées en machine à 30°.

Самое подходящее слово для описания коллекции подвесных ламп дизайнера Бенжамин Хуберта – молодежная. Данная коллекция навеяна формами кирпичных плиток крыш домов. Второе слово – развлекательная, потому что лампу можно собрать всем вместе, надевая пластины на металлическую структуру. В-третьих, эта лампа – современная, ее пластины состоят из полужесткого эластичного резинового материала, пригодного для машинной стирки при 30 градусах.

# ROOFER

---

La collezione è costituita da sospensioni per interno, di cinque forme diverse, con la possibilità di installarle anche a plafone accorcandone i cavi. Il telaio è ricoperto da scaglie in materiale gommoso semirigido, in quattro tonalità di colore diverse (bianco, grigio, marrone e verde), mentre il diffusore circolare è in tessuto bianco. L'elettrificazione è a tensione di rete per lampade alogene e fluorescenti.

La colección está constituida por lámparas colgantes de interior, de cinco formas distintas, con la opción de instalarlas también como plafones al acortar los cables. El bastidor está cubierto por escamas de un material de goma semirígido, en cuatro colores distintos (blanco, gris, marrón y verde) y el difusor circular es textil blanco. La electrificación es con tensión de red para bombillas halógenas y fluorescentes.

Die Kollektion besteht aus Hängelampen für Innenbereiche, in fünf verschiedenen Formen, mit der Möglichkeit, sie auch als Deckenleuchten durch Kürzung der Kabel zu verwenden. Der Rahmen ist von Splittern aus gummiartigem halbstarrem Material in vier verschiedenen Farbtönen bedeckt (weiß, grau, braun und grün), während der kreisförmige Diffusor aus weißem Gewebe ist. Die Elektrifizierung erfolgt über Netzspannung bei Halogen- und Fluoreszenz-Lampen.

The collection is made up of hanging lamps for indoor use, in five different shapes, and can also be fitted directly to the ceiling rose by simply shortening the cables. The frame is covered in scales made of a semi-rigid rubbery material, in four different colours (white, grey, brown and green), while the round diffuser is in white fabric. The lamp runs on mains power and is suitable for use with halogen and fluorescent bulbs.

La collection est constituée de suspensions d'intérieur, de cinq formes différentes, avec la possibilité de les installer au plafond en raccourcissant leurs câbles. La structure est recouverte d'écaillés en matériau caoutchouteux semi-rigide, en quatre couleurs différentes (blanc, gris, marron et vert), alors que le diffuseur circulaire est réalisé en tissu blanc. Les lampes halogènes et fluorescentes sont alimentées par la tension du réseau.

Коллекция состоит из подвесных ламп для внутренних помещений, 5-ти разных форм. Лампы также можно прикрепить напрямую к потолку, укоротив кабеля. Каркас покрыт пластинами из полужесткого эластичного резинового материала 4-х оттенков (белый, серый, коричневый и зеленый), круглый рассеиватель белого цвета. Электрическая часть рассчитана на галогеновые и люминесцентные лампы от сетевого напряжения.



**ROOFER**  
Benjamin Hubert

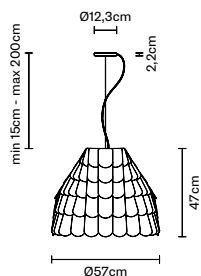

**code**

**electrification**

**technical info**

**accessories**

**F12 A01**

- 01 White
- 21 Anthracite
- 32 Orange
- 43 Green

E27 220-240V  
1x205W HSGST



**EAC IP20**

0,241 m<sup>3</sup>  
6,38 kg

NOT INCLUDED:  
- Lampadina / Bulb

E27 220-240V  
1x30W FBT

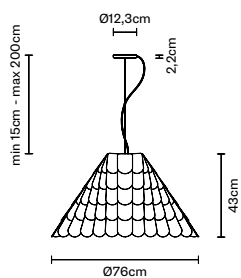

**F12 A03**

- 01 White
- 21 Anthracite
- 32 Orange
- 43 Green

E27 220-240V  
1x205W HSGST



**EAC IP20**

0,356 m<sup>3</sup>  
4,71 kg

NOT INCLUDED:  
- Lampadina / Bulb

E27 220-240V  
1x30W FBT



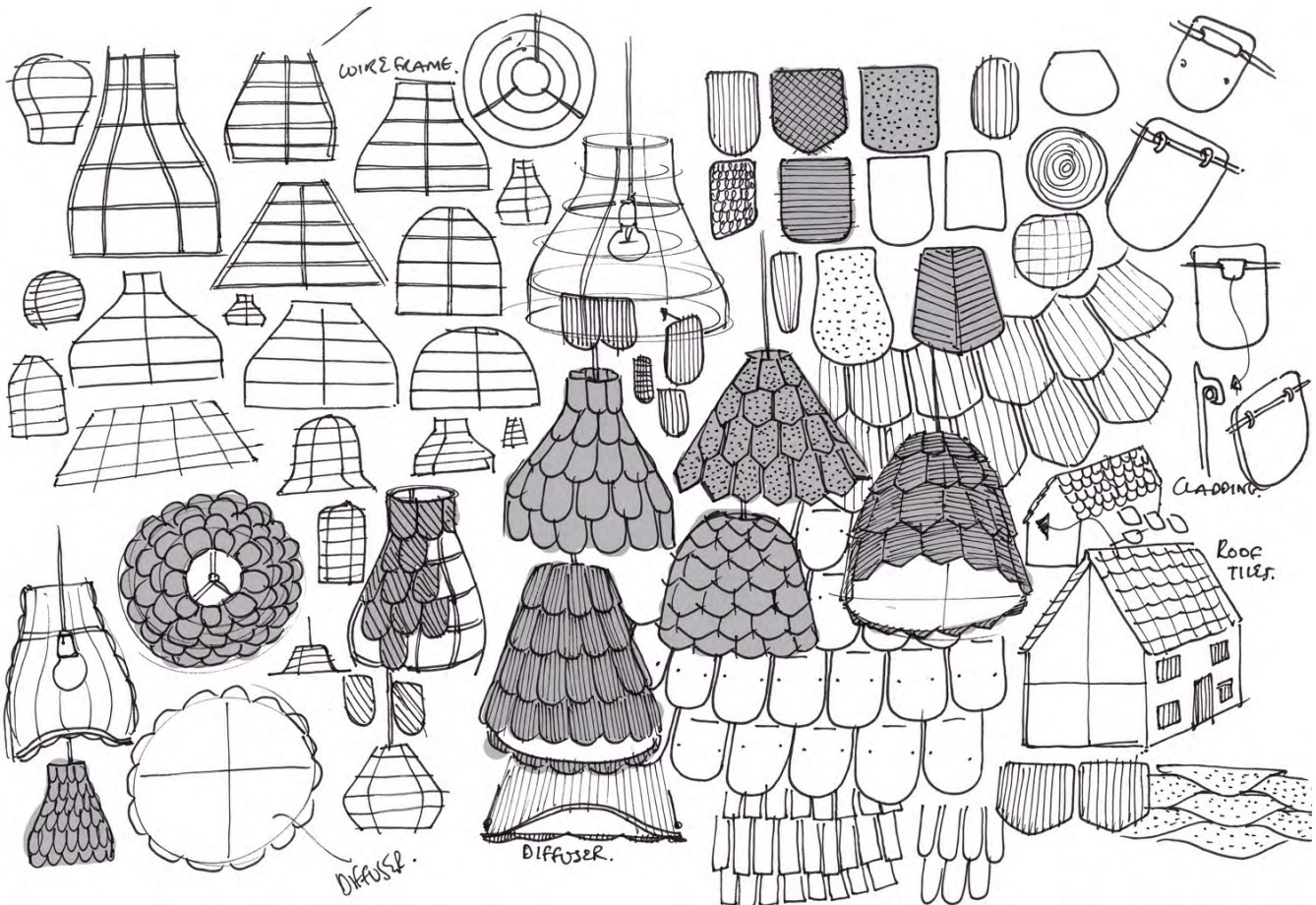

**ROOFER**  
Benjamin Hubert

**code**                      **electrification**                      **technical info**                      **accessories**

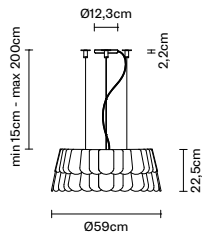

**F12 A05**  
01 White  
21 Anthracite  
32 Orange  
43 Green

E27 220-240V  
6x22W FBT



**EAC** IP20  
0,231 m<sup>3</sup>  
7,29 kg

NOT INCLUDED:  
- Lampadina / Bulb

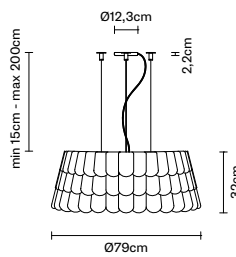

**F12 A07**  
01 White  
21 Anthracite  
32 Orange  
43 Green

E27 220-240V  
6x30W FBT



**EAC** IP20  
0,345 m<sup>3</sup>  
4,97 kg

NOT INCLUDED:  
- Lampadina / Bulb

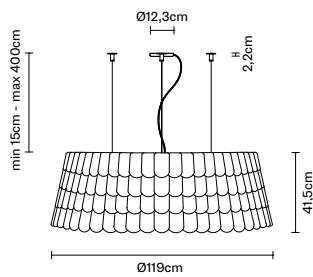

**F12 A09**  
01 White  
21 Anthracite  
32 Orange  
43 Green

E27 220-240V  
12x30W FBT



**EAC** IP20  
0,683 m<sup>3</sup>  
13,63 kg

NOT INCLUDED:  
- Lampadina / Bulb

# SNAKE

—

Francesco Lucchese



Snake è disponibile nella versione da parete e soffitto per interno. La struttura, sinuosa e dinamica, è in silicone colorato (bianco, nero, blu, arancio e verde) e cromo lucido che sorregge un diffusore in pirex bianco. La lampada, permettendo una grande flessibilità delle forme e varietà nei tagli di luce, permette di creare vivaci spazi contemporanei. L'elettrificazione è a tensione di rete per lampade alogene.

Snake existe en la versión aplique y plafón de interior. La estructura, sinuosa y dinámica, es de silicona de color (blanco, negro, azul, naranja y verde) y cromo brillante, que soporta un difusor de Pyrex blanco. La lámpara, al permitir una gran flexibilidad en las formas y en la variedad de los cortes de luz, crea espacios alegres contemporáneos. La electrificación es con tensión de red para bombillas halógenas.

Snake ist in der Wand- und Deckenausführung für Innenbereiche erhältlich. Die geschmeidige und dynamische Struktur besteht aus farbigem Silikon (weiß, schwarz, blau, orange und grün) und Glanzchrom, die einen Diffusor aus weißem Pyrex trägt. Die Lampe ermöglicht eine große Flexibilität der Formen und Unterschiede in den Lichteinschnitten und bildet so lebhaftere kontemporäre Räume. Die Elektrifizierung erfolgt über Netzspannung bei Halogen-Lampen.

The Snake range includes wall and ceiling lamps for indoor use. A diffuser in white pirex is attached to the end of its winding, dynamic structure is available in coloured silicon (white, black, blue, orange and green) and polished chrome. It is very flexible and can be adjusted to assume different shapes and light directions to create lively contemporary spaces. The lamp runs on mains power and is suitable for use with halogen bulbs.

Snake est disponible en version murale et en version plafonnier pour intérieur. La structure sinueuse et dynamique est en silicone coloré (blanc, noir, bleu, orange et vert) et en chrome poli qui soutient un diffuseur en pyrex blanc. La lampe permet de créer des espaces contemporains vivaces, tout en offrant une grande flexibilité au niveau des formes et une variété dans les découpes de la lumière. Les lampes halogènes sont alimentées par la tension du réseau.

Светильник Snake представлен в настенной и потолочной версиях для внутренних помещений. Его извилистая и динамическая структура из цветного силикона (белого, черного, синего, оранжевого и зеленого цветов) и полированного хрома держит рассеиватель из белого пирекса. Светильник имеет гибкую форму и возможность разнообразного рассеивания света, что позволяет создать оживленную современную обстановку. Электрическая часть рассчитана на галогеновые лампы от сетевого напряжения.







**SNAKE**  
 Francesco Lucchese

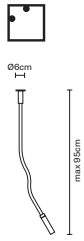

**code**

**D63 G01**  
 01 White  
 02 Black  
 31 Blue  
 32 Orange  
 43 Green

**electrification**

G9 220-240V  
 1x48W HSGS



**technical info**

**ERC**  **IP40**  
 360°  
 ADJUSTABLE  
 SYSTEM  
 0,01 m<sup>3</sup>  
 1,71 kg

**accessories**

NOT INCLUDED:  
 - Lampadina / Bulb

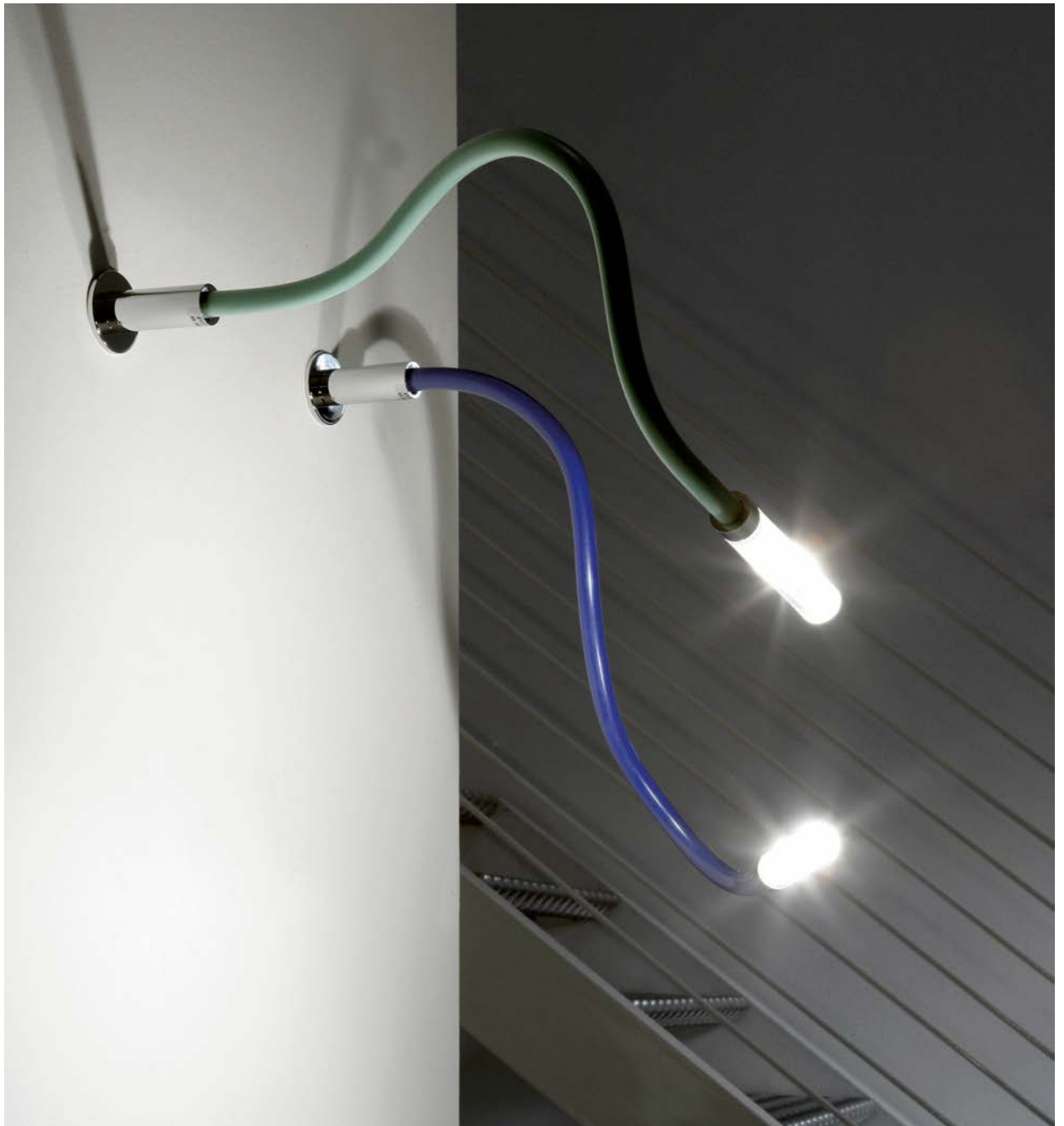

# SOSPESA

—

Paolo De Lucchi / Lisa Bellon



## CONCEPT

---

In quanti modi si può rappresentare la leggerezza? Ma soprattutto, può una lastra di vetro apparire leggera? Ecco la sfida dei designers Paolo De Lucchi e Lisa Bellon che con la loro Sospesa hanno voluto rispondere a queste domande. Una lampada in grado di illuminare anche spazi ampi con raffinata eleganza, che sembra liberarsi nell'aria sfidando la legge di gravitazione universale. Grazie alla sua unicità nella produzione e alla sua imponenza, Sospesa dà valore e pregio agli spazi in cui viene inserita. La fresatura per l'alloggiamento del circuito elettrico la rende ancor più preziosa, valorizzandone l'essenziale bellezza che la contraddistingue.

How many ways are there for expressing lightness? Above all, however, can a plate of glass appear lightweight? This was the challenge faced by designers Paolo De Lucchi and Lisa Bellon who aimed to answer these questions with their Sospesa model. This lamp elegantly illuminates even vast spaces and appears to float in the air, defying all rules of gravity. Thanks to its unique manufacturing process and imposing character, Sospesa adds value and class to any room. It's essential beauty is further enhanced by the grooves which embed the electric circuit.

¿En cuántos modos se puede representar la ligereza? Pero sobre todo, ¿una plancha de vidrio puede parecer ligera? Es el reto de los diseñadores Paolo De Lucchi y Lisa Bellon que han querido contestar a dichas preguntas con su lámpara Sospesa. Una lámpara para iluminar espacios también amplios con una elegancia refinada, que parece liberarse en el aire y desafiar la ley de la gravedad universal. Sospesa, con su unicidad en la producción y su aspecto imponente, aporta valor y calidad a los espacios. El fresado para alojar el circuito eléctrico otorga más valor a esta lámpara al destacar su belleza esencial característica.

Auf welche Weise kann man Leichtigkeit darstellen? Kann eine Glasplatte überhaupt leicht erscheinen? Das war die Herausforderung der Designer Paolo De Lucchi und Lisa Bellon, die mit ihrer Sospesa auf diese Fragen antworten wollten. Eine Lampe, die auch große Räume mit ausgesuchter Eleganz erleuchtet, sich in der Luft zu befreien und die universelle Schwerkraft herauszufordern scheint. Dank der Einzigartigkeit ihrer Produktion und ihrer Bedeutung verleiht Sospesa den Räumen Wert und Eleganz. Die Fräsung für den Einsatz der Elektrifizierung gestaltet sie noch wertvoller und hebt ihre essentielle unterscheidende Schönheit hervor.

La légèreté peut être représentée sous combien de formes ? Mais surtout, une plaque de verre peut-elle apparaître légère ? Voilà le défi relevé par les designers Paolo De Lucchi et Lisa Bellon qui, avec leur Sospesa, ont voulu répondre à ces questions. Une lampe en mesure d'éclairer également de grands espaces avec une élégance raffinée, qui semble se libérer dans l'air en défiant la loi de la gravitation universelle. Grâce à son unicité au niveau de la production et de son air majestueux, Sospesa enrichit les espaces dans lesquels elle est insérée. Le fraisage pour le logement du circuit électrique la rend encore plus précieuse, tout en valorisant la beauté essentielle qui la caractérise.

Сколькими способами можно передать ощущение легкости? И вообще, может ли стеклянная пластина казаться легкой? Эти вопросы бросили вызов дизайнерам Паоло Де Лукки и Лизе Беллон, которые ответили на них, создав светильник Sospesa. Этот утонченный элегантный светильник может освещать большие пространства, он как-будто освобождается в воздухе и опровергает законы всемирного тяготения. Уникальность производства и грандиозность светильника Sospesa придает ощущение значимости и важности помещениям, в которых он установлен. Фрезерная обработка каналов для электрической цепи подчеркивает ценность и естественную красоту этого светильника.

# SOSPESA

La collezione è costituita da sospensioni e lampade da parete per interno. Il diffusore è costituito da una lastra piana in vetro extra chiaro temprato, trasparente e struttura in metallo lucido. Il circuito elettrico scorre nei canali tracciati nella lastra. La sospensione è disponibile in forma rettangolare o quadrata e in varie dimensioni. L'elettrificazione è a bassissima tensione (12V) per lampade alogene e LED e a bassa tensione di rete per lampade alogene.

La colección está compuesta por lámparas colgantes y apliques de interior. El difusor está constituido por una plancha plana de vidrio extraclaro templado, transparente y por una estructura de metal brillante. El circuito eléctrico recorre los canales trazados en la plancha. La lámpara colgante está disponible en la forma rectangular o cuadrada y en distintos tamaños. La electrificación es con tensión muy baja (12V) para bombillas halógenas y LED y con baja tensión de red para bombillas halógenas.

Die Kollektion besteht aus Hänge- und Wandleuchten für den Innenbereich. Der Diffusor besteht aus einer extrahellen transparenten und temperierten Flachglasplatte; verchromte Metallstruktur. Der Stromkreis verläuft in den Plattenkanälen. Die Hängeleuchte ist viereckig oder rechteckig und in mehreren Abmessungen verfügbar. Elektrifizierung mit Niederspannung (12V) für Halogen- und LED-Lampen und mit Netzspannung für Halogenlampen.

The collection consists of hanging and wall lamps for indoor use. The diffuser is made up of a flat sheet of extra transparent, tempered glass and a structure in polished metal. The electronic circuit runs along the grooves in the glass. The hanging lamp model is available in a rectangle or square and in different sizes. The lamps run on a very low voltage (12V) for halogen and LED bulbs and low mains power for halogen bulbs.

La collection se compose de suspensions et d'appliques murales d'intérieur. Le diffuseur est constitué par une plaque plane en verre très clair, trempé, transparent et par une structure en métal poli. Le circuit électrique court le long des goulottes tracées dans la plaque. La suspension est disponible sous forme rectangulaire ou carrée et en différentes dimensions. Les lampes halogènes et LED sont alimentées à très basse tension (12V) et les lampes halogènes à basse tension par la tension du réseau.

Коллекция состоит из подвешного и настенного светильников для внутреннего освещения. Рассеиватель из плоского листа суперсветлого прозрачного закаленного стекла. Структура из блестящего металла. Электрическая цепь проходит по каналам, прорезанным в стекле. Подвесная часть может быть прямоугольной или квадратной формы различных размеров. Электрическая часть рассчитана на галогеновую лампу при очень низком напряжении (12V) и на светодиодную лампу при низком сетевом напряжении.



**SOSPESA**

Paolo De Lucchi / Lisa Bellon

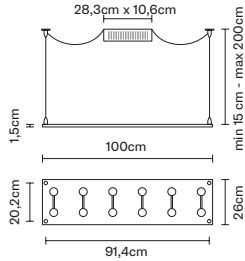

**D42 A01**  
00 Transparent  
G4 220-240V  
12x20W HSGS

**ERACIP20**   
0,079 m<sup>3</sup>  
14,19 kg

INCLUDED:  
- Trasformatore elettronico / *Electronic transformer*

NOT INCLUDED:  
- Lampadina / *Bulb*

**D42 A15**  
00 Transparent  
G4 220-240V  
12x3W

**ERACIP20**   
0,079 m<sup>3</sup>  
**LED** 13,92 kg

INCLUDED:  
- Trasformatore elettronico / *Electronic transformer*

NOT INCLUDED:  
- Lampadina / *Bulb*

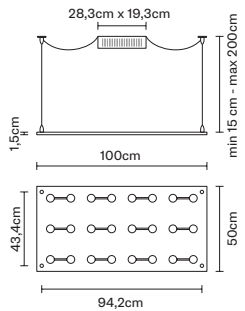

**D42 A05**  
00 Transparent  
G4 220-240V  
24x20W HSGS

**ERACIP20**   
0,143 m<sup>3</sup>  
24,68 kg

INCLUDED:  
- Trasformatore elettronico / *Electronic transformer*

NOT INCLUDED:  
- Lampadina / *Bulb*

**D42 A19**  
00 Transparent  
G4 220-240V  
24x3W

**ERACIP20**   
0,132 m<sup>3</sup>  
**LED** 22,71 kg

INCLUDED:  
- Trasformatore elettronico / *Electronic transformer*

NOT INCLUDED:  
- Lampadina / *Bulb*

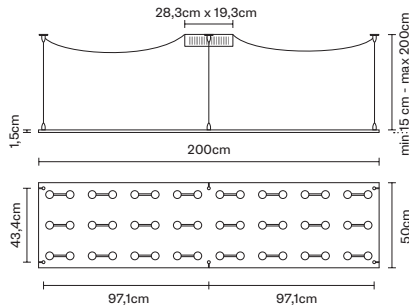

**D42 A09**  
00 Transparent  
G4 220-240V  
48x10W HSGS

**ERACIP20**   
0,217 m<sup>3</sup>  
34,38 kg

INCLUDED:  
- Trasformatore elettronico / *Electronic transformer*

NOT INCLUDED:  
- Lampadina / *Bulb*

**D42 A21**  
00 Transparent  
G4 220-240V  
48x3W

**ERACIP20**   
0,217 m<sup>3</sup>  
**LED** 34,38 kg

INCLUDED:  
- Trasformatore elettronico / *Electronic transformer*

NOT INCLUDED:  
- Lampadina / *Bulb*

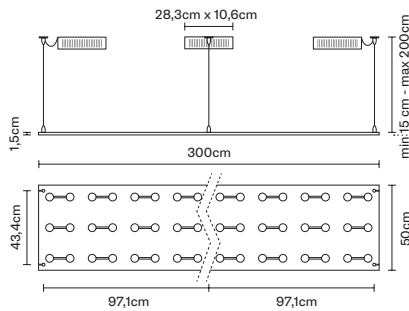

**D42 A13**  
00 Transparent  
G4 220-240V  
72x10W HSGS

**ERACIP20**   
0,619 m<sup>3</sup>  
41,50 kg

INCLUDED:  
- Trasformatore elettronico / *Electronic transformer*

NOT INCLUDED:  
- Lampadina / *Bulb*

**D42 A25**  
00 Transparent  
G4 220-240V  
72x3W

**ERACIP20**   
0,619 m<sup>3</sup>  
**LED** 41,50 kg

INCLUDED:  
- Trasformatore elettronico / *Electronic transformer*

NOT INCLUDED:  
- Lampadina / *Bulb*

# SPIRITO DI VENEZIA

—

Gian Paolo Canova





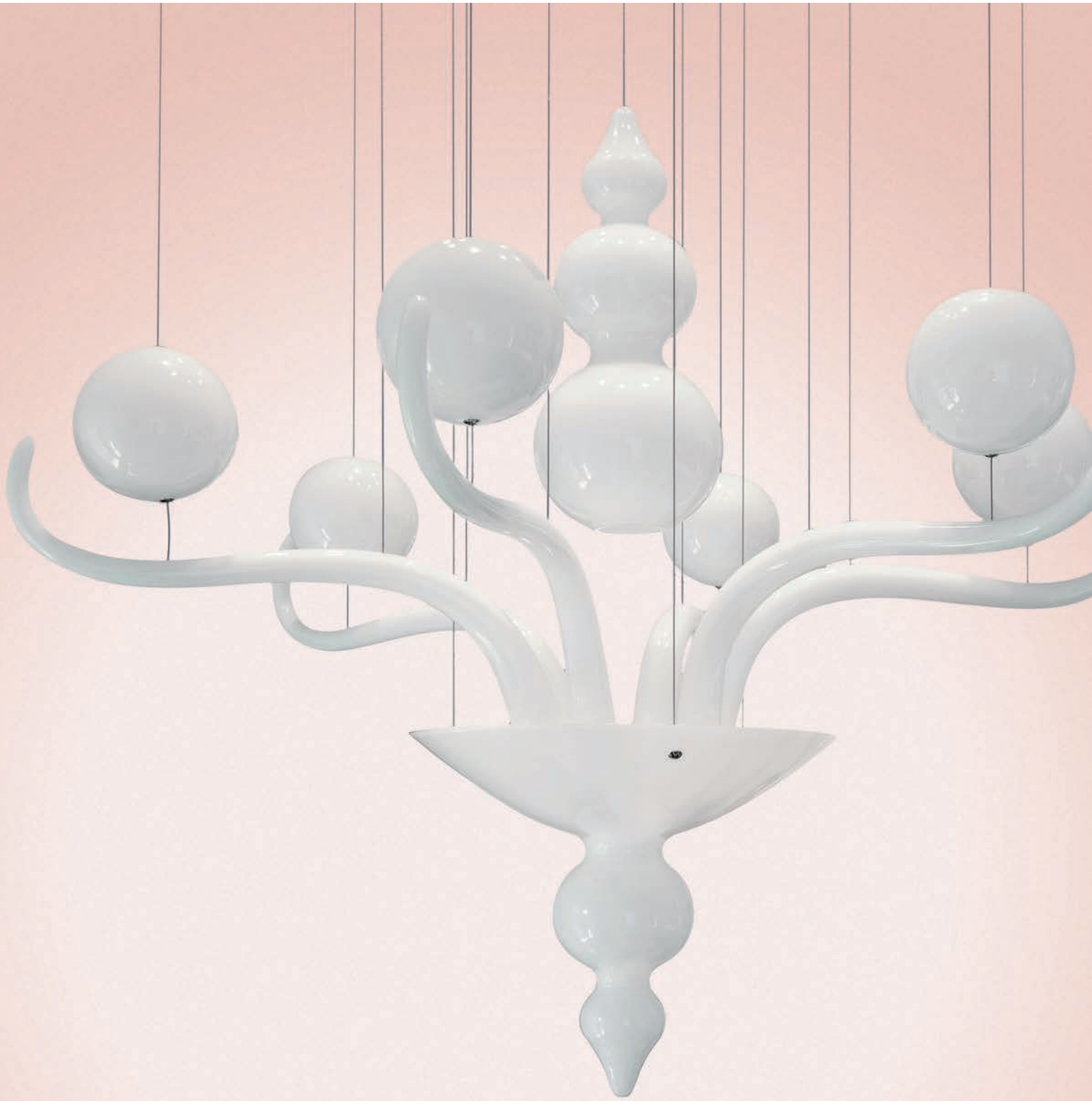



## CONCEPT

---

L'intenzione del designer Gian Paolo Canova è stata quella di voler creare un lampadario composto solo del vetro e depurato da tutti gli elementi meccanici come aste, coppe metalliche, portalampane, in modo da sembrare pura immaterialità. Ecco un oggetto indovinato, di grande suggestione e interessante sotto il profilo del linguaggio.

Questa collezione è semplice nella sua realizzazione e non è contaminata da alcun elemento che lo possa appesantire. Il vetro non è più l'elemento decorato che sostiene la luce, ma è l'oggetto che viene illuminato per mostrarsi nella sua bellezza. I suoi bracci non portano più le luci ma sono solo forma e decoro.

When creating this model, designer Gian Paolo Canova intended to create a chandelier using only glass, totally free of any mechanical elements such as rods, metallic bowls and lamp holders, to give it a feel of pure immateriality. He succeeded with this highly charming and intriguing object.

This collection exudes simplicity and is not contaminated by any element that could make it appear heavy. Glass is no longer merely the decorated element around a light source but is illuminated to show off its beauty. Its arms no longer hold the lights but are themselves the shape and decoration.

Las intenciones del diseñador Gian Paolo Canova eran crear una araña compuesta solamente por el elemento vidrio y depurada de todos los elementos mecánicos, tales como barras, tulipas metálicas, portalampane para parecer inmaterialidad pura. El resultado es un objeto acertado, altamente sugestivo e interesante desde el punto de vista del lenguaje. Esta colección es sencilla en su realización y no resulta contaminada por elementos que puedan restarle ligereza. El vidrio ha dejado de ser el elemento decorado, que soporta la luz, para convertirse en el objeto que se ilumina para mostrar su belleza. Sus brazos no soportan las luces y son solamente forma y decoración.

Die Absicht des Designers Gian Paolo Canova war, eine Lampe zu kreieren, die nur aus Glas besteht und frei von allen mechanischen Elementen, wie Stangen, Metallkappen, Lampenträgern ist, um als reine Immaterialität zu erscheinen. So entstand ein gelungenes Objekt, mit hoher Suggestion und in puncto Ausdruck sehr interessant.

Diese Kollektion ist in ihrer Ausführung einfach und durch kein erschwerendes Element beeinträchtigt. Das Glas ist nicht mehr das dekorierte Lichtträgerelement, sondern der Gegenstand, der beleuchtet wird, um sich in seiner Schönheit zu zeigen. Seine Arme tragen das Licht nicht, sondern stellen nur Form und Dekor dar.

L'intention du designer Gian Paolo Canova a été de vouloir créer un lustre uniquement composé de verre et épuré de tous les éléments mécaniques comme les tiges, les coupes métalliques, les porte-lampes, afin de révéler une pure immatériabilité. Voilà un objet intuitif, très suggestif et intéressant sous l'aspect du langage.

Cette collection est simple au niveau de sa réalisation et n'est contaminée par aucun élément susceptible de l'alourdir. Le verre n'est plus l'élément décoré qui soutient la lumière, mais est l'objet qui est éclairé pour se manifester sous toute sa beauté. Ses bras ne jouent plus un rôle de support pour les lumières, mais gagnent en forme et en prestige.

Дизайнер Джан Паоло Канова хотел создать люстру, используя только стекло, без механических элементов вроде стержней, металлических чашек и патронов, чтобы она смотрелась абсолютно вне материи. Этот заслуживающий внимания предмет на самом деле имеет очень эффектный вид. Коллекция люстр проста в своей концепции и не отягощена лишними деталями. Стекло перестает быть декоративным элементом, содержащим свет, но становится светящейся материей во всей своей красоте. Ответвления люстры больше не являются держателями для ламп, а отдельными формами и декорациями.

# SPIRITO DI VENEZIA

La collezione è costituita da due sospensioni di grandezza diversa per interno. La struttura è in metallo verniciato bianco che illumina i decori in vetro soffiato trasparenti e bianchi sostenuti da cavetti in acciaio inox. Queste lampade si adattano perfettamente ad ambienti raffinati ed eleganti conferendo atmosfere di luce uniche e senza tempo. L'elettrificazione è a tensione di rete per lampade alogene.

La colección está compuesta por dos lámparas colgantes con distintos tamaños de interior. La estructura es de metal pintado blanco, que ilumina las decoraciones de vidrio soplado transparente y blanco, soportada por cables de acero inoxidable. Estas lámparas encajan perfectamente en ambientes refinados y elegantes para crear atmósferas con luces únicas y ajenas al paso del tiempo. La electrificación es con tensión de red para bombillas halógenas.

Die Kollektion besteht aus zwei Hängelampen in verschiedenen Größen für Innenbereiche. Die Struktur besteht aus weiß lackiertem Metall und beleuchtet die Dekore aus geblasenem transparentem und weißem Glas, die von Edelstahlkabeln getragen werden. Diese Lampen eignen sich perfekt für außergewöhnliche und elegante Umgebungen und verleihen einzigartige und zeitlose Lichtatmosphären. Die Elektrifizierung erfolgt über Netzspannung bei Halogen-Lampen.

The collection is made up of two hanging lamps in different sizes for indoor use. The structure is painted white which illuminates the decorations in transparent and white blown glass, supported by thin stainless steel wires. These lamps are perfectly suited to refined, elegant settings where they will create a unique, timeless atmosphere. The lamp runs on mains power and is suitable for use with halogen bulbs.

La collection est constituée par deux suspensions d'intérieur de grandeur différente. La structure en métal verni blanc éclaire les décorations transparentes et blanches en verre soufflé soutenues par de petits câbles en acier inox. Ces lampes s'adaptent parfaitement aux espaces raffinés et élégants, tout en offrant des atmosphères de lumière uniques et intemporelles. Lampes halogènes alimentées par la tension de réseau.

Коллекция состоит из двух люстр-подвесов в двух размерах для внутренних помещений. Металлическая структура с белым лаковым покрытием освещает декорации из белого и прозрачного выдувного стекла, подвешенных на тончайших тросах из нержавеющей стали. Эти люстры прекрасно смотрятся в изысканном и элегантном интерьере, создавая исключительную и неповторимую атмосферу. Электрическая часть рассчитана на галогеновые лампы от сетевого напряжения.



**SPIRITO DI VENEZIA**

Gian Paolo Canova

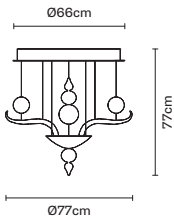
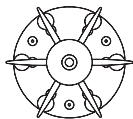

*code*

*electrification*

*technical info*

*accessories*

**F10 A01**  
**00** *Transparent*

GU10 220-240V  
6x50W HAGS/UB



**EAC** IP20  
0,171 m<sup>3</sup>  
18,94 kg

NOT INCLUDED:  
- Lampadina / *Bulb*

**F10 A01**  
**01** *White*

GU10 220-240V  
6x50W HAGS/UB



**EAC** IP20  
0,171 m<sup>3</sup>  
18,94 kg

NOT INCLUDED:  
- Lampadina / *Bulb*

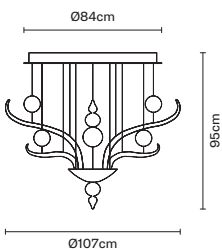
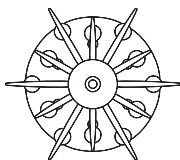

**F10 A03**  
**00** *Transparent*

GU10 220-240V  
9x50W HAGS/UB



**EAC** IP20  
0,306 m<sup>3</sup>  
20,49 kg

NOT INCLUDED:  
- Lampadina / *Bulb*

**F10 A03**  
**01** *White*

GU10 220-240V  
9x50W HAGS/UB



**EAC** IP20  
0,306 m<sup>3</sup>  
20,49 kg

NOT INCLUDED:  
- Lampadina / *Bulb*

# STICK

—

Matali Crasset







## CONCEPT

---

Stick nasce da un modulo in legno Ayous la cui forma si ispira a quella di una pinza: due elementi piegati e tesi da un supporto centrale. “Questo dettaglio – spiega la designer francese Matali Crasset – è il vocabolario che dà vita ad una collezione di lampade basata sulla sua ripetizione. Mentre la texture del legno permette il diffondersi di una luce morbida e calda, la ripetizione del modulo crea un gioco di grafismi e di ombre inattese.” Si parte da un unico modulo che si comporta al pari di una materia plasmabile: in questo modo si riveste la sorgente luminosa, la si “addomestica” e si diffonde una luce sfumata dalla levigatezza del legno.

Stick stems from an Ayous wood module, the shape of which is inspired by that of a pair of pliers: two bent elements stretched apart by a central support. “This detail – explains French designer, Matali Crasset, is the vocabulary that gives life to a lamp collection based on its repetition. While the texture of the wood allows the diffusion of a soft, warm light, the repetition of the module creates a graphic pattern and unexpected shadows. Modules made in a flexible material are joined together and “tamed” to surround the light source. The light produced is veiled by the smoothness of the wood.

Stick se construye a partir de un módulo de madera Ayous, cuya forma se inspira en la de una pinza: dos elementos plegados y tensados mediante un soporte central. “Este detalle – explica la diseñadora francesa Matali Crasset – es el vocabulario que da vida a una colección de lámparas basada en la repetición. Por su parte la textura de la madera permite difundir una luz suave y cálida mientras que la repetición del módulo crea un juego de grafismos y sombras inesperadas”. Se parte de un módulo único que se comporta como una materia plasmable: de esta forma se reviste la fuente luminosa, se la “domestica” y se difunde una luz difuminada suave como la madera.

Stick entsteht aus einem Modul aus Ayous-Holz, dessen Form an die einer Zange angelehnt ist: Zwei gebogene Elemente, die durch einen zentralen Träger fixiert werden. “Dieses Detail”, erklärt die französische Designerin Matali Crasset, “ist das Vokabular, das diese neue Kollektion ausmacht, welche auf ihrer eigenen Wiederholbarkeit basiert. Während es die Textur des Holzes ermöglicht, ein warmes und weiches Licht zu verbreiten, schafft die Wiederholbarkeit des Moduls ein überraschendes Spiel von Schatten und Grafiken. Die Basis stellt ein einziges Modul dar, das die Eigenschaften einer formbaren Materie besitzt: So entsteht die Lichtquelle, wird “gezähmt” und verbreitet ein weiches Licht, das durch die Holzfasern strahlt.

Stick a été créée à partir d'un module en bois d'Ayous dont la forme s'inspire à celle d'une pince: deux éléments pliés et tendus par un support central. “Ce détail – explique la designer française Matali Crasset – est le fil conducteur d'une collection de lampes caractérisée par un aspect répétitif. Alors que la texture du bois permet de diffuser un éclairage ténu et chaud, la répétition du module crée un jeu de graphismes et d'ombres inattendues.” On part d'un seul module qui se comporte comme une matière malléable: de cette manière, la source lumineuse se déguise, elle est “domestiquée” et un éclairage nuancé par le polissage du bois se diffuse.

Светильник Stick рождается из дерева Ayous, его форма навеяна структурой зажима: два согнутых элемента на центральном держателе. “Эта деталь, – сказала французский дизайнер Матали Крассе, – основа, которая дает начало целой коллекции ламп. В то время как фактура дерева способствует распространению мягкого теплого света, множественность модуля создает игру неожиданных графизмов и теней”. За основу берется единый модуль, который, как податливая материя, обволакивает источник света, “приручает” его и рассеивает смягченный гладкостью дерева свет.

# STICK

La collezione si compone di lampade a sospensione, una lampada da tavolo, alcune piantane, e un applique per interno. La diffusione della luce è affidata ad un'intelaiatura ornata di listelli in Ayous, un legno chiaro di origine africana, mentre lo stelo delle piantane è in legno Toulipier, un legno chiaro di origine nordamericana. Per tutte, la struttura portante è in metallo verniciato. L'elettrificazione è a tensione di rete per lampade fluorescenti e LED.

La colección está compuesta por lámparas colgantes, una lámpara de sobremesa, algunas lámparas de pie y un aplique de interior. La difusión de la luz es realizada por un bastidor adornado con listones de madera Ayous, una madera clara de origen africano mientras que el pie es de madera Toulipier, una madera clara de origen norteamericano. En todas las lámparas, la estructura de soporte es de metal pintado. La electrificación es con tensión de red para bombillas fluorescentes y LED.

Die Kollektion besteht aus Hängelampen, Tischlampen, Bodenlampen und Wandlampen für innen. Die Verbreitung des Lichts wird durch ein mit einer Zierleiste aus Ayous-Holz versehenem Gewebe ermöglicht, ein helles afrikanisches Holz, während der Schaft der Bodenlampen aus Toulipierholz ist, das aus Nordamerika stammt. Die tragende Struktur besteht aus lackiertem Metall. Die Elektrifizierung erfolgt über Netzspannung bei Fluoreszenz- und LED-Lampen.

The collection is made up of pendant lamps, one table lamp, various floor lamps and one wall lamp, all for indoor use. The light is diffused through an ornate weave of slats in Ayous, a light-coloured wood found in Africa, while the stem of the floor lamps is in Toulipier, a light-coloured wood from North America. The structure of all the lamp models is in painted metal. The lamp runs on mains power and is suitable for use with fluorescent and LED bulbs.

La collection se compose de lampes à suspension, lampes de table, de lampadaires et d'une applique pour intérieur. La diffusion de la lumière est confiée à une structure ornée de lattes en Ayous, un bois clair d'origine africaine, alors que le pied des deux lampadaires est en bois de Tulipier, un bois clair originaire d'Amérique du nord. Pour toutes ces lampes, la structure portante est en métal verni. Les lampes fluorescentes et LED sont alimentées par la tension du réseau.

Коллекция включает настольную лампу, бра, подвесные светильники и торшеры. Рассеивание света происходит за счет каркаса с деревянными планками из африканского дерева Ayous светлого цвета. В торшерах стембель сделан изсеверо-американского дерева Toulipier светлого цвета. Несущие структуры всех светильников сделаны из окрашенного металла. Электрическая часть рассчитана на люминесцентные и светодиодные лампы от сетевого напряжения.





**STICK**  
Matali Crasset

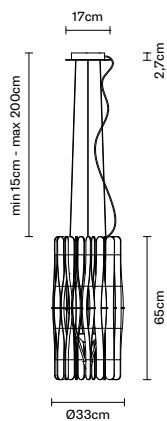

**code**      **electrification**      **technical info**      **accessories**

**F23 A01**  
69 Light wood  
colour

E27 220-240V  
1x23W FBC

**EAC** IP20  
0,095 m<sup>3</sup>  
3,04 kg

INCLUDED:  
- Lampadina / Bulb



**F23 A06**  
69 Light wood  
colour

LED 220-240V  
1x8.7W-120°  
WHITE 3000K  
800lm Cri >80

**EAC** IP20  
0,016 m<sup>3</sup>  
3,32 kg

INCLUDED:  
- LED / LED



LED 220-240V  
1x13W-120°  
WHITE 3000K  
1210lm Cri >80



Dimmerabile TRIAC / Dimmable TRIAC

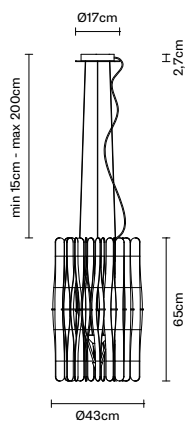

**F23 A02**  
69 Light wood  
colour

E27 220-240V  
1x23W FBC

**EAC** IP20  
0,139 m<sup>3</sup>  
3,42 kg

INCLUDED:  
- Lampadina / Bulb



**F23 A07**  
69 Light wood  
colour

LED 220-240V  
1x8.7W-120°  
WHITE 3000K  
800lm Cri >80

**EAC** IP20  
0,016 m<sup>3</sup>  
3,71 kg

INCLUDED:  
- LED / LED



LED 220-240V  
1x17W-120°  
WHITE 2700K  
1850lm Cri >80



Dimmerabile TRIAC / Dimmable TRIAC



**STICK**  
Matali Crasset

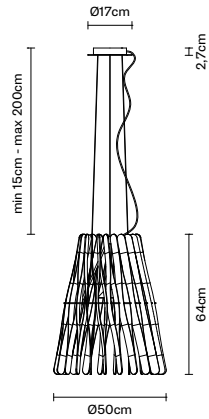

**code**      **electrification**      **technical info**      **accessories**

**F23 A03**  
69 Light wood  
colour

E27 220-240V  
1x23W FBC

**EAC** IP20  
0,181 m<sup>3</sup>  
3,24 kg

INCLUDED:  
- Lampadina / Bulb

**F23 A08**  
69 Light wood  
colour

LED 220-240V  
1x8.7W-120°  
WHITE 3000K  
800lm Cri >80

**EAC** IP20  
0,016 m<sup>3</sup>  
3,53 kg

INCLUDED:  
- LED / LED

LED 220-240V  
1x17W-120°  
WHITE 2700K  
1850lm Cri >80

Dimmerabile TRIAC / Dimmable TRIAC

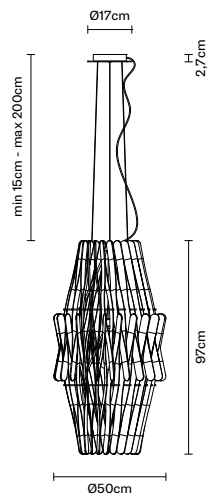

**F23 A05**  
69 Light wood  
colour

E27 220-240V  
1x23W FBC

**EAC** IP20  
0,325 m<sup>3</sup>  
6,22 kg

INCLUDED:  
- Lampadina / Bulb

**F23 A10**  
69 Light wood  
colour

LED 220-240V  
1x8.7W-120°  
WHITE 3000K  
800lm Cri >80

**EAC** IP20  
0,315 m<sup>3</sup>  
6,42 kg

INCLUDED:  
- LED / LED

LED 220-240V  
1x17W-120°  
WHITE 2700K  
1850lm Cri >80

Dimmerabile TRIAC / Dimmable TRIAC



**STICK**  
Matali Crasset

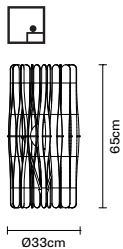

**code**      **electrification**      **technical info**      **accessories**

**F23 B01**  
69 Light wood  
colour

E27 220-240V  
1x23W FBC

**EAC** IP20  
0,089 m<sup>3</sup>  
2,17 kg

INCLUDED:  
- Lampadina / Bulb

**F23 B02**  
69 Light wood  
colour

LED 220-240V  
1x8.7W-120°  
WHITE 3000K  
800lm Cri >80

**EAC** IP20  
0,008 m<sup>3</sup>  
2,37 kg

INCLUDED:  
- LED / LED  
- Alimentatore elettronico / Electronic driver

LED 220-240V  
1x13W-120°  
WHITE 3000K  
1210lm Cri >80

**LED**

Dimmerabile TRIAC / Dimmable TRIAC

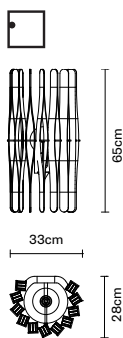

**F23 D01**  
69 Light wood  
colour

E27 220-240V  
1x23W FBC

**EAC** IP20  
0,089 m<sup>3</sup>  
1,94 kg

INCLUDED:  
- Lampadina / Bulb

**F23 D02**  
69 Light wood  
colour

LED 220-240V  
1x8.7W-120°  
WHITE 3000K  
800lm Cri >80

**EAC** IP20  
0,089 m<sup>3</sup>  
1,94 kg

INCLUDED:  
- LED / LED

LED 220-240V  
1x13W-120°  
WHITE 3000K  
1210lm Cri >80

**LED**

Dimmerabile TRIAC / Dimmable TRIAC



**STICK**  
Matali Crasset

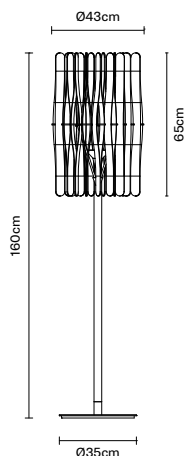

**code**

**electrification**

**technical info**

**accessories**

**F23 C01**

69 Light wood  
colour

E27 220-240V  
1x23W FBC



**ERC** IP20  
0,405 m<sup>3</sup>  
13,66 kg

INCLUDED:  
- Lampadina / Bulb

**F23 C05**

69 Light wood  
colour

LED 220-240V  
1x8.7W-120°  
WHITE 3000K  
800lm Cri >80



**ERC** IP20  
0,016 m<sup>3</sup>  
14,06 kg

INCLUDED:  
- LED / LED  
- Alimentatore elettronico / Electronic driver

LED 220-240V  
1x17W-120°  
WHITE 2700K  
1850lm Cri >80



Dimmerabile TRIAC / Dimmable TRIAC

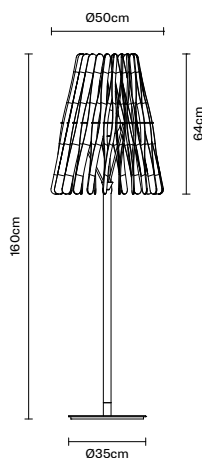

**F23 C02**

69 Light wood  
colour

E27 220-240V  
1x23W FBC



**ERC** IP20  
0,447 m<sup>3</sup>  
13,48 kg

INCLUDED:  
- Lampadina / Bulb

**F23 C06**

69 Light wood  
colour

LED 220-240V  
1x8.7W-120°  
WHITE 3000K  
800lm Cri >80



**ERC** IP20  
0,016 m<sup>3</sup>  
14,06 kg

INCLUDED:  
- LED / LED  
- Alimentatore elettronico / Electronic driver

LED 220-240V  
1x17W-120°  
WHITE 2700K  
1850lm Cri >80



Dimmerabile TRIAC / Dimmable TRIAC

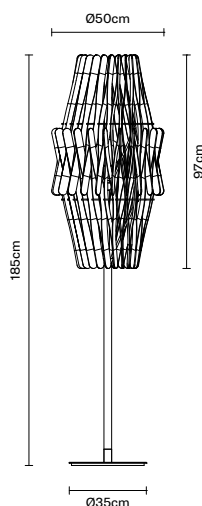

**F23 C04**

69 Light wood  
colour

E27 220-240V  
1x23W FBC



**ERC** IP20  
0,578 m<sup>3</sup>  
16,25 kg

INCLUDED:  
- Lampadina / Bulb

**F23 C08**

69 Light wood  
colour

LED 220-240V  
1x8.7W-120°  
WHITE 3000K  
800lm Cri >80



**ERC** IP20  
0,016 m<sup>3</sup>  
14,06 kg

INCLUDED:  
- LED / LED  
- Alimentatore elettronico / Electronic driver

LED 220-240V  
1x17W-120°  
WHITE 2700K  
1850lm Cri >80



Dimmerabile TRIAC / Dimmable TRIAC

# TOROIDALE

DesignZagato





# CONCEPT

---

La forma geometrica della sospensione Toroidale è ispirata allo schema primario che la natura utilizza su ogni scala: il solido geometrico toro. Dopo un attento studio sul sistema legato a questo tipo di struttura, DesignZagato ha progettato la lampada di grandi dimensioni e dalla spiccata personalità, un sistema in equilibrio che si ritrova in natura in molti contesti, dall'atomo al campo magnetico terrestre. Questa sospensione è stata pensata soprattutto per ampi spazi pubblici e di rappresentanza, perché riesce a riempire e decorare gli ambienti con eleganza e leggerezza.

The geometric shape of the Toroidale hanging lamp is inspired by the primary basis used by nature at every level: the geometric solid known as the torus. After carefully studying the lighting systems possible with this type of structure, DesignZagato came up with this large lamp with a distinct personality, a balanced system that is found in many spheres of nature, from the atom to the earth's magnetic field. This hanging lamp was designed above all for use in large public spaces and showrooms, because it is able to fill and decorate any room with elegance and lightness.

La forma geométrica de la lámpara colgante Toroidale se inspira en el esquema primario que la naturaleza usa en cada escala: el sólido geométrico toro. DesignZagato, tras haber efectuado un estudio meticuloso sobre este tipo de estructura, ha diseñado una lámpara de grandes dimensiones y con una personalidad destacada, un sistema en equilibrio, que encontramos en la naturaleza en numerosos marcos, desde en el átomo hasta en el campo magnético terrestre. Esta lámpara colgante se ha pensado sobre todo para amplios espacios públicos y de representación, porque logra llenar y decorar los ambientes con elegancia y ligereza.

Die geometrische Form der Hängelampe Toroidale inspiriert sich am primären Schema, welches die Natur überall nutzt: Der Volltorus. Nach einer aufmerksamen Studie des mit dieser Strukturart verbundenen Systems, hat DesignZagato die große und herausragende Lampe entwickelt, ein ausgeglichenes System, das sich in vielen Umgebungen in der Natur befindet, vom Atom bis zum Erdmagnetfeld. Diese Hängelampe wurde vor allem für öffentliche und Vertretungsbereiche entwickelt, da sie Umgebungen mit Eleganz und Leichtigkeit ausfüllt und dekoriert.

La forme géométrique de la suspension Toroidale s'est inspirée du schéma primaire que la nature utilise à tous les niveaux: le solide géométrique tore. Après une étude minutieuse sur le système lié à ce type de structure, DesignZagato a conçu une lampe aux grandes dimensions et avec une personnalité prononcée, un système en équilibre qui se trouve dans beaucoup de contextes dans la nature, de l'atome au champ magnétique terrestre. Cette suspension a surtout été conçue pour de grands espaces publics et de réception, car elle parvient à remplir et à décorer les espaces avec élégance et légèreté.

Геометрическая форма светильника-подвеса Toroidale заимствована в первичной схеме, масштабно используемой природой: геометрическое тело тороида. После тщательного изучения необходимой структуры, дизайн-студия DesignZagato создала светильник больших размеров интересной формы, основанной на существующей в природе концепции равновесия, как например форма атома или магнитное поле Земли. Подвесной светильник создан для больших общественных мест и холлов, чтобы изысканно заполнить и украсить пространство.

# TOROIDALE

---

La collezione è costituita da una sospensione per interno. Il diffusore è in polietilene stampato in rotazionale con all'interno una fascia in policarbonato con decoro floreale utilizzata per schermare la luce. L'elettrificazione è a tensione di rete per lampade fluorescenti.

La colección está compuesta por una lámpara colgante de interior. El difusor es de polietileno realizado en un elemento rotativo, con en su interior una franja de policarbonato con decoraciones florales para apantallar la luz. La electrificación es con tensión de red para bombillas fluorescentes.

Die Kollektion besteht aus einer Hängelampe für innen. Der rotationsgeformte Diffusor ist aus Polyethylen und weist intern einen Polykarbonatbereich mit Blumendekoration auf, der das Licht abschirmt. Die Elektrifizierung erfolgt über Netzspannung für Fluoreszenz-Lampen.

The collection consists of hanging lamps for indoor use. The diffuser is in rotomoulded polyethylene, with a strip of polycarbonate in the centre bearing a floral decoration, used to screen the light. The lamp runs on mains power and is suitable for use with fluorescent bulbs.

La collection est constituée d'une suspension pour intérieur. Le diffuseur est en polyéthylène moulé par rotation avec une bande en polycarbonate et une décoration florale utilisée pour tamiser la lumière. Lampes fluorescentes alimentées par la tension de réseau.

Коллекция состоит из подвешенного светильника для внутренних помещений. Рассеиватель со структурой из полиэтилена, изготовленного методом штамповки с вращением. Внутренняя лента из поликарбоната с цветочной декорацией служит для затенения света. Электрическая часть рассчитана на люминесцентную лампу от сетевого напряжения.



**TOROIDALE**  
DesignZagato

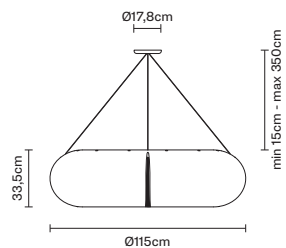

**code**

**electrification**

**technical info**

**accessories**

**D71 A01**  
**00 Transparent**

E27 220-240V  
12x22W FBT



**EAC** IP20  350°  
ADJUSTABLE SYSTEM  
0,625 m<sup>3</sup>  
16,85 kg

**INCLUDED:**  
- Doppia accensione / *Double switch*

**NOT INCLUDED:**  
- Lampadina / *Bulb*



# TRIPLA

—  
Desall / Devis Busato & Giulia Ciccarese







# CONCEPT

---

I giovani designer Devis Busato e Giulia Ciccarese, vincitori del contest indetto da Fabbian Illuminazione in collaborazione con Desall, hanno dato origine a questa serie di lampade decorative in vetro cristallo.

Tripla nasce dalla forma basica del triangolo e si evolve nell'elemento volumetrico della piramide. La sua forma tetraedrica si propone come completamento alla raccolta Fabbian di lampade dalle forme essenziali. Solida e preziosa, riveste la luce con versatilità, eleganza e modularità, permettendo lo sviluppo di diverse applicazioni e adattandosi a tutti gli ambienti.

The young designers Devis Busato and Giulia Ciccarese, winners of the competition organised by Fabbian Illuminazione in collaboration with Desall, came up with this series of highly decorative lamps in crystal.

The concept behind Tripla is the basic triangle, which evolves, acquiring volume to become a pyramid. Its tetrahedral shape is a fine addition to Fabbian's collections of lamps in essential shapes. Its solid, exquisite design produces a versatile, elegant and modular light for different applications and settings.

Los jóvenes diseñadores Devis Busato y Giulia Ciccarese, ganadores del contest convocado por Fabbian Illuminazione en colaboración con Desall, han creado esta serie de lámparas decorativas de vidrio cristal.

Tripla deriva de la forma básica del triángulo y se desarrolla en el elemento volumétrico de la pirámide. Su forma en tetraedro completa la colección de Fabbian de lámparas con formas esenciales. Sólida y preciosa, viste la luz con versatilidad, elegancia y modularidad para permitir el desarrollo de distintas aplicaciones y adaptarse a todos los ambientes.

Die jungen Designer Devis Busato und Giulia Ciccarese, Sieger des von Fabbian Illuminazione in Zusammenarbeit mit Desall organisierten Contest, haben dieser Dekorationslampenserie aus Kristallglas Leben geschenkt. Tripla entstand aus der Grundform des Dreiecks und entwickelte sich in das volumetrische Element einer Pyramide. Ihre tetraedrische Form präsentiert sich als Vervollständigung der Fabbian-Lampenkollektion mit essentiellen Formen. Solide und wertvoll verbreitet sie das Licht vielseitig, elegant und modular und ermöglicht so die Entwicklung verschiedener Anwendungen, die sich allen Umgebungen anpassen.

Les jeunes designers Devis Busato et Giulia Ciccarese, vainqueurs du concours organisé par Fabbian Illuminazione en collaboration avec Desall, ont donné naissance à cette série de lampes de décoration en verre cristal. Tripla, dont la base est triangulaire se développe grâce à l'élément volumétrique de la pyramide. Sa forme tétraédrique complète la collection de lampes Fabbian dont les formes sont essentielles. Ces lampes sont solides et précieuses, leur lumière est universelle, élégante et modulable. Elles s'adaptent à tout type d'environnement et s'intègrent dans tout type de pièce.

Эта коллекция декоративных ламп из хрустального стекла была создана молодыми дизайнерами Девисом Бузато и Джулией Чиккаресе, победителями конкурса, организованного Fabbian Illuminazione при содействии Desall. Коллекция Tripla основана на базовой форме треугольника, которая эволюционирует в объемный элемент пирамиды. Благодаря своим четырехгранным контурам светильники гармонично дополняют коллекцию ламп геометрических форм Fabbian. Элегантные и практичные светильники, благодаря своей универсальности, утонченности и модульности, гармонично вписываются в интерьеры любого стиля и могут находить самое различное применение, в зависимости от желания и фантазии декоратора.

# TRIPLA

---

La collezione Tripla è composta da una sospensione, una lampada da tavolo, una lampada da parete, una da soffitto e un incasso in un'unica dimensione ma in tre differenti finiture della struttura: alluminio lucido, grigio antracite e verniciata bronzo. Inoltre è disponibile in sistemi finiti o completamente personalizzabili con struttura delle lampade in tre varianti colore, i rosoni sono disponibili in due dimensioni e nelle tre opzioni di finitura. Tutte le lampade sono per interno. I diffusori sono in vetro cristallo. L'elettrificazione è a tensione di rete per LED con alimentatore dimmerabile integrato.

La colección Tripla está compuesta por una lámpara colgante, una lámpara de sobremesa, un aplique, un plafón y un foco en un solo tamaño pero con tres acabados distintos para la estructura: aluminio brillante, gris antracita y pintada de color bronce. Asimismo existe en sistemas acabados o completamente personalizables con estructura de las lámparas en tres colores distintos; los rosetones existen en dos tamaños y en las tres opciones de acabado. Todas las lámparas son de interior. Los difusores son de vidrio cristal. La electrificación es con tensión de red para Led con un alimentador electrónico integrado con intensidad de la luz regulable.

Die Kollektion Tripla besteht aus einer Hängelampe, einer Tischlampe, einer Wandlampe, einer Deckenlampe und einer Einbaulampe mit einer einzigartigen Abmessung, aber in drei verschiedenen Ausführungen der Struktur: poliertes Alu, anthrazitgrau und bronzelackiert. Außerdem ist sie in Fertigsystemen erhältlich oder ganz individuell gestaltbar, wobei die Struktur der Lampen in drei Farbvarianten angeboten wird; die Rosetten sind in zwei Abmessungen und in drei Ausführungen erhältlich. Alle Lampen sind für Innenbereiche. Die Diffusoren sind aus Kristallglas. Die Elektrifizierung erfolgt über Netzspannung für LED mit integriertem, dimmerbarem Netzteil.

The Tripla collection is made up of one hanging lamp, one table lamp, one wall lamp and one ceiling lamp. It also includes a recessed lighting fixture which is flat yet available in three different finishes: polished aluminium, anthracite grey and a bronze plate. It is also available in modular systems and can also be fully personalised with lamps in three colour variants, while the ceiling roses are available in two sizes and in three different finishes. All the lamps are for indoor use. The diffusers are in crystal. The energy voltage is LED with an incorporated dimmer switch.

La collection Tripla se compose d'une lampe suspension, d'une lampe de table, d'une applique murale, d'un plafonnier et d'une lampe encastrable d'une seule dimension mais dont la structure est possède trois types de finitions différentes : aluminium brillant, gris anthracite et peinture couleur bronze. Cette lampe est par ailleurs disponible sous la forme de systèmes finis ou totalement personnalisable. La structure des lampes est proposée avec trois couleurs différentes, les rosettes sont proposées dans deux dimensions dans les trois finitions de couleurs. Toutes les lampes sont conçues pour l'intérieur. Les diffuseurs sont en verre de cristal. Elles utilisent des ampoules à LED et sont munies d'un variateur de lumière.

Коллекция Tripla включает в себя подвесной светильник, настольную лампу, бра, люстру и встраиваемый в стену светильник; размер моделей стандартный, однако они имеют отделку трех видов: глянцевый алюминий, серый антрацит и окраска под бронзу. Кроме того, помимо готовых моделей можно приобрести светильники на заказ: структура ламп может иметь три различных оттенка, розетки доступны в двух размерах и трех вариантах отделки. Все светильники предназначены для интерьеров. Рассеиватели выполнены из хрустального стекла. Цоколь предназначен для светодиода (LED) и оснащен блоком питания с регулятором яркости.





**TRIPLA**

Desall / Devis Busato & Giulia Ciccarese

**code**

**electrification**

**technical info**

**accessories**

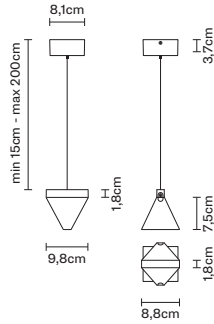

**F41 A01**

**11 Polished aluminium**  
**21 Anthracite**  
**76 Bronze**

LED 220-240V  
1x4.3W-120°  
WHITE 3000K  
540lm CRI >80

**EAC** IP40

INCLUDED:

- LED / LED
- Alimentatore elettronico dimmerabile / Dimmable electronic driver

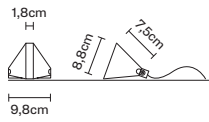

**F41 B01**

**11 Polished aluminium**  
**21 Anthracite**  
**76 Bronze**

LED 220-240V  
1x4.3W-120°  
WHITE 3000K  
540lm CRI >80

**EAC** IP40

INCLUDED:

- LED / LED
- Alimentatore elettronico dimmerabile / Dimmable electronic driver

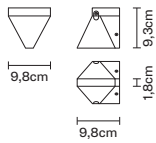

**F41 D01**

**11 Polished aluminium**  
**21 Anthracite**  
**76 Bronze**

LED 220-240V  
1x4.3W-120°  
WHITE 3000K  
540lm CRI >80

**EAC** IP40

INCLUDED:

- LED / LED
- Alimentatore elettronico dimmerabile / Dimmable electronic driver

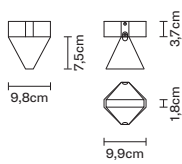

**F41 E01**

**11 Polished aluminium**  
**21 Anthracite**  
**76 Bronze**

LED 220-240V  
1x4.3W-120°  
WHITE 3000K  
540lm CRI >80

**EAC** IP40

INCLUDED:

- LED / LED
- Alimentatore elettronico dimmerabile / Dimmable electronic driver

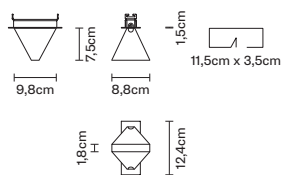

**F41 F01**

**11 Polished aluminium**  
**21 Anthracite**  
**76 Bronze**

LED 220-240V  
1x4.3W-120°  
WHITE 3000K  
540lm CRI >80

**EAC** IP40

INCLUDED:

- LED / LED
- Alimentatore elettronico dimmerabile / Dimmable electronic driver





**TRIPLA**

Desall / Devis Busato & Giulia Ciccarese

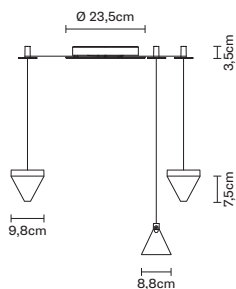

**code**

**electrification**

**technical info**

**accessories**

**F41 G01**

**11 Polished aluminium**  
**21 Anthracite**  
**76 Bronze**

LED 220V-240V  
3x4.3W-120°  
WHITE 3000K  
1620lm CRI >80



**EAC** IP40

INCLUDED:

- LED / LED
- Alimentatore elettronico dimmerabile / Dimmable electronic driver

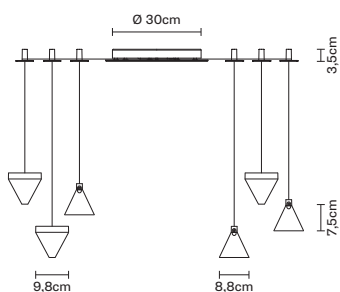

**F41 G03**

**11 Polished aluminium**  
**21 Anthracite**  
**76 Bronze**

LED 220V-240V  
6x4.3W-120°  
WHITE 3000K  
4860lm CRI >80



**EAC** IP40

INCLUDED:

- LED / LED
- Alimentatore elettronico dimmerabile / Dimmable electronic driver

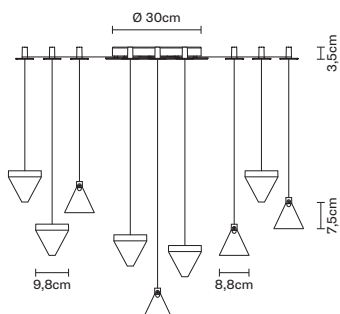

**F41 G05**

**11 Polished aluminium**  
**21 Anthracite**  
**76 Bronze**

LED 220V-240V  
9x4.3W-120°  
WHITE 3000K  
3240lm CRI >80



**EAC** IP40

INCLUDED:

- LED / LED
- Alimentatore elettronico dimmerabile / Dimmable electronic driver

# VICKY



Nicola Design



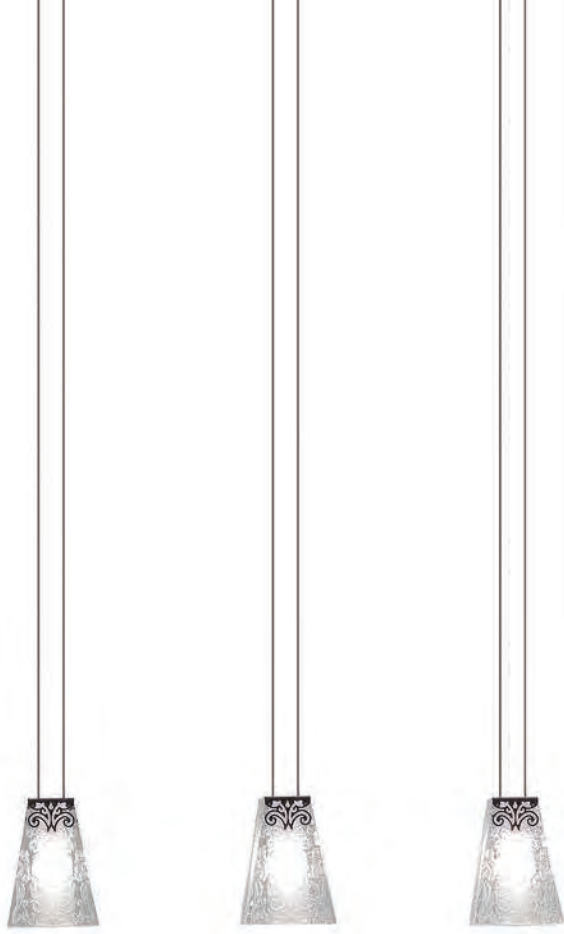



# CONCEPT

---

Vicky ha un carattere forte che traspare dalla luce modellata dalle decorazioni floreali di stile indiano impresse nel cristallo, un segno dolce sull'ornamento trasferito alla produzione industriale. Una rottura al minimalismo. Il designer dello studio Nicola Design spiega: "Vicky contamina gli spazi raffreddati ed influenzati dall'omologazione che in questi anni ci circondano, è una collezione in cromo e cristallo, una fusione tra tecnologia, arte e design. Questa collezione si caratterizza da una grande modernità nelle linee e scelte tecnologiche e una grande maestria nella produzione del cristallo".

The strong personality of Vicky exudes from the light, which is modelled by the Indian-style floral decorations embossed in the crystal, adding a soft touch to this industrially produced item. A break from minimalism. As its creator from the Nicola Design studio explains: "Vicky contaminates spaces which are made cold and influenced by standardization that have surrounded us in these years. The collection is in chrome and crystal, a blend between technology, art and design. This collection has strikingly modern lines and technological solutions and shows real craftsmanship in the production of the crystal elements".

Vicky presenta un carácter fuerte, que se vislumbra en la luz modelada por las decoraciones florales de estilo indio impresas en el cristal, un signo suave en el ornamento trasladado a la producción industrial. Una ruptura con el minimalismo. El diseñador del estudio Nicola Design explica: "Vicky contamina los espacios enfriados e influenciados por la homologación que, a lo largo de estos años, nos ha ido rodeando, es una colección de cromo y cristal, una fusión entre tecnología, arte y diseño. Esta colección se caracteriza por una gran modernidad en las líneas y las elecciones tecnológicas y una gran maestría en la producción del cristal".

Vicky hat einen starken Charakter, der durch das Licht der Blumendekors des Kristalls im indischen Stil scheint, ein zartes Zeichen der auf die Industrieproduktion übertragenen Verzierung. Ein Riss des Minimalismus. Der Designer des Studios Nicola Design erklärt: „Vicky beeinflusst die kühlen und sterilen Räume, die uns in diesen Jahren umgeben; es ist eine Kollektion aus Chrom und Kristallglas, eine Verbindung aus Technologie, Kunst und Design. Diese Kollektion zeichnet sich durch ihren sehr modernen Stil, die technischen Entscheidungen sowie die hohe Kunst der Kristallglasproduktion aus.“

Vicky: un caractère fort, diffusé par la lumière modelée par les décorations florales style indien gravées dans le cristal, une note de légèreté sur la décoration désormais présente dans la production industrielle. Une rupture avec le minimalisme. Le designer du studio Nicola Design nous explique: "Vicky contamine les espaces froids et influencés par l'homologation qui, nous a entouré durant ces années. Il s'agit d'une collection en chrome et cristal, une fusion entre la technologie, l'art et le design. Cette collection est caractérisée par une grande modernité des lignes et des choix technologiques et par un savoir-faire extraordinaire dans la production du cristal".

У светильника Vicky яркий характер. Свет просачивается через цветочные гравировки в индийском стиле. Этот нежный узор перенесен на поверхность кристалла в производстве, навсегда отказавшись от минимализма. Дизайнер студии Nicola Design объясняет: «Светильник Vicky меняет холодные и зараженные аналогичностью пространства, которые нас окружают в последнее время. Коллекция светильников Vicky из хрома и кристалла – это слияние технологии, искусства и дизайна. Данная коллекция отличается современностью линий, новыми технологиями и высоким мастерством в производстве кристалла».

# VICKY

---

La collezione è disponibile con sospensioni, lampade da tavolo, da parete e soffitto per interno. I diffusori sono in cristallo, le strutture in cromo lucido. Le versioni da tavolo sono dotate di un paralume in tessuto bianco o nero provviste di doppia sorgente luminosa con conseguente doppia accensione. Per tutte le tipologie c'è la possibilità di montare il vetro capovolto per creare composizioni libere. L'elettrificazione è a tensione di rete per lampade alogene.

La colección está disponible con lámparas colgantes, lámparas de sobremesa, apliques y plafones de interior. Los difusores son de cristal y las estructuras de cromo brillante. Las versiones de sobremesa tienen una pantalla textil blanca o negra con una fuente luminosa doble y el consiguiente encendido doble. Para todos los tipos, cabe la posibilidad de montar el cristal invertido para crear composiciones libres. La electrificación es con tensión de red para bombillas halógenas.

Die Kollektion besteht aus Hängelampen, Tisch-, Decken- und Wandlampen für innen. Die Diffusoren sind aus Kristallglas, die Strukturen aus Glanzchrom. Die Tischausführungen sind mit einer Abschirmung aus weißem oder schwarzem Gewebe mit doppelter Leuchtquelle und somit einer Doppelschaltung ausgestattet. Für alle Typologien besteht die Möglichkeit, das Glas umgekehrt zu montieren, um freie Zusammenstellungen zu bilden. Die Elektrifizierung erfolgt über Netzspannung bei Halogen-Lampen.

The collection is made up of hanging, table, wall and ceiling lamps for indoor use. The diffusers are in crystal while the structures are in polished chrome. The table lamps have a lampshade in white or black fabric and a double light source, and consequently a double light switch. For all models, it is possible to mount the glass upside-down to allow freedom of design. The lamp runs on mains power and is suitable for use with halogen bulbs.

Cette collection est disponible avec des suspensions, des lampes de table, des lampes murales et des plafonniers pour intérieur. Les diffuseurs sont en cristal, les structures en chromepoli. Les versions de table sont munies d'un abat-jour en tissu blanc ou noir et d'une double source d'éclairage avec un allumage double. Pour toutes ces typologies, il y a la possibilité de monter le verre renversé pour créer des compositions au choix. Lampes halogènes alimentées par la tension du réseau.

Коллекция состоит из подвесных, настольных, настенных и потолочных светильников для внутренних помещений. Рассеиватели из кристалла, металлические структуры из блестящего хрома. Настольный светильник имеет абажур из белого или черного материала с двойным источником света и двойным выключателем. Стекланную часть всех моделей можно устанавливать в перевернутом виде, создавая тем самым разнообразные композиции. Электрическая часть рассчитана на галогеновую лампу от сетевого напряжения.





**VICKY**  
Nicola Design

**code**                      **electrification**                      **technical info**                      **accessories**

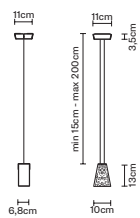

**D69 A01**  
**00 Transparent**

G9 220-240V  
1x60W HSGS

**EAC** IP20  
0,01 m<sup>3</sup>  
1,97 kg

NOT INCLUDED:  
- Lampadina / Bulb

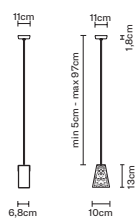

**D69 A99**  
**00 Transparent**

G9 220-240V  
1x60W HSGS

**EAC** IP20  
0,035 m<sup>3</sup>  
2,98 kg

NOT INCLUDED:  
- Lampadina / Bulb

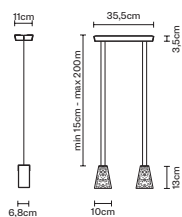

**D69 A03**  
**00 Transparent**

G9 220-240V  
2x60W HSGS

**EAC** IP20  
0,017 m<sup>3</sup>  
4,38 kg

NOT INCLUDED:  
- Lampadina / Bulb

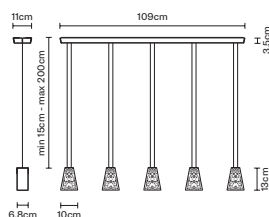

**D69 A05**  
**00 Transparent**

G9 220-240V  
5x60W HSGS

**EAC** IP20  
0,098 m<sup>3</sup>  
11,58 kg

NOT INCLUDED:  
- Lampadina / Bulb

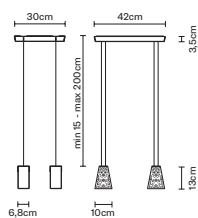

**D69 A07**  
**00 Transparent**

G9 220-240V  
4x60W HSGS

**EAC** IP20  
0,07 m<sup>3</sup>  
10,00 kg

NOT INCLUDED:  
- Lampadina / Bulb





**VICKY**  
Nicola Design

**code**      **electrification**      **technical info**      **accessories**

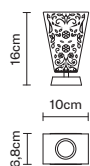

**D69 B01**  
**00 Transparent**

G9 220-240V  
1x60W HSGS



**EAC**  **IP20**  
0,01 m<sup>3</sup>  
1,73 kg

NOT INCLUDED:  
- Lampadina / *Bulb*

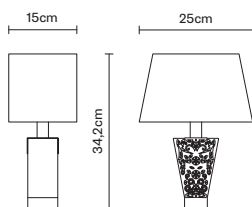

**D69 B03**  
**01 White**  
**02 Black**

G9 220-240V  
1x48W HSGS



**EAC**  **IP20**  
0,035 m<sup>3</sup>  
2,59 kg

INCLUDED:  
- Doppia accensione / *Double switch*  
  
NOT INCLUDED:  
- Lampadina / *Bulb*

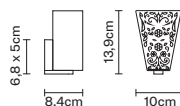

**D69 D01**  
**00 Transparent**

G9 220-240V  
1x60W HSGS



**EAC**  **IP20**  
0,01 m<sup>3</sup>  
1,85 kg

NOT INCLUDED:  
- Lampadina / *Bulb*

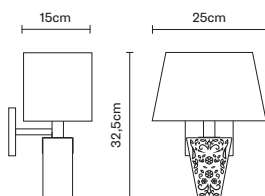

**D69 D03**  
**01 White**  
**02 Black**

G9 220-240V  
1x48W HSGS



**EAC**  **IP20**  
0,035 m<sup>3</sup>  
2,79 kg

INCLUDED:  
- Doppia accensione / *Double switch*  
  
NOT INCLUDED:  
- Lampadina / *Bulb*

G9 220-240V  
1x20W HSGS

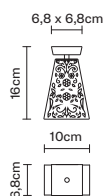

**D69 E01**  
**00 Transparent**

G9 220-240V  
1x60W HSGS



**EAC**  **IP20**  
0,01 m<sup>3</sup>  
1,75 kg

NOT INCLUDED:  
- Lampadina / *Bulb*

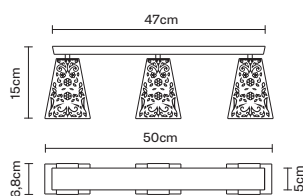

**D69 E03**  
**00 Transparent**

G9 220-240V  
3x60W HSGS



**EAC**  **IP20**  
0,045 m<sup>3</sup>  
5,55 kg

NOT INCLUDED:  
- Lampadina / *Bulb*



**TECHNICAL**

—

# CLAQUE

—

Marc Sadler



## CONCEPT

---

L'ispirazione di questa serie di lampade nasce dal mondo teatrale, dove gli artisti sul palcoscenico vengono seguiti dalle luci che esaltano le loro performance. In questo contesto la luce diventa la protagonista dello spettacolo, ha la facoltà di drammatizzare o alleggerire una scena, creare ritmo o suspense. Allo stesso modo questa collezione di proiettori indirizza la luce verso l'elemento che si desidera evidenziare, lasciando che il resto dell'ambiente viva di luce riflessa. Proprio come le "Claque", persone reclutate per applaudire o fischiare, che hanno la facoltà di determinare la luce, o il successo, di uno spettacolo.

This lamp series is inspired to the theatrical world, where the artists on stage are followed by lights that highlight their performances. In this context, the light becomes the star, by dramatizing or lightening a scene, and creating rhythm or suspense. In the same way, this ceiling light collection directs the light toward the element to be highlighted, illuminating the rest of the environment with a reflected beam. Just as the "Claque", the people paid to applaud or whistle, who can determine the enlightenment, or success, of a play.

Esta serie de lámparas se inspira en el mundo del teatro, donde los artistas en el escenario son seguidos por luces, que exaltan sus actuaciones. En este marco, la luz se convierte en la protagonista del espectáculo, logra dramatizar o aligerar una escena, crear ritmo y suspense. De la misma forma, esta colección de proyectores orienta la luz hacia el elemento, que se quiere destacar, dejando que el resto del ambiente viva de una luz reflejada. Precisamente como las «Claque», personas reclutadas para aplaudir o abuchear, con la facultad de determinar la luz, o el triunfo, de un espectáculo.

Diese Linie inspiriert sich an den Scheinwerfern der Theaterbühnen, mit denen die Künstler beleuchtet werden, um ihre Darbietung ins rechte Licht zu rücken. In diesem Zusammenhang ist die Beleuchtung ein unverzichtbares Element des Schauspiels, das dramatische Effekte hervorrufen oder eine Szene auflockern, Rhythmus schaffen oder Spannung entstehen lassen kann. Genauso lenken die Strahler dieser Kollektion das Licht auf den Punkt, der hervorgehoben werden soll, und überlassen das übrige Ambiente der diffusen Reflexion. Vergleichbar mit der „Claque“, einer Gruppe von Personen, die das Publikum im Theater zum Applaudieren animiert und somit den Glanz also den Erfolg eines Schauspiels bestimmen kann.

L'inspiration de cette série de lampes est issue du monde théâtral, où les artistes sur la scène sont suivis par des lumières qui exaltent leurs performances. Dans ce contexte, la lumière devient la protagoniste du spectacle, elle a la faculté de dramatiser ou d'alléger une scène, de créer du rythme ou du suspense. De la même manière, cette collection de projecteurs dirige la lumière vers l'élément que l'on désire mettre en évidence, en faisant en sorte que le reste de l'environnement vive de lumière réfléchie. A l'instar des "Claqueurs", personnes engagées pour applaudir ou siffler, elles ont la faculté de déterminer la lumière ou le succès d'un spectacle.

Вдохновением этой серии ламп послужил театральный мир, в котором свет прожекторов направлен на актеров на сцене, чтобы превознести их игру. В этом контексте свет становится главным актером, может возбудить или разрядить обстановку, ускорить ритм или усилить напряжение. Точно так же эта коллекция ламп направляет свет на те объекты, которые нуждаются в прямом освещении, оставляя оставшуюся часть помещения в отраженном свете. Подобно людям, которых нанимают, чтобы рукоплескать или покрыть свистом игру актеров в театре и определить их успех или провал, лампы "Claque" направляют свет на актеров в помещении, решая их судьбу в спектакле.

# CLAUQUE

---

La famiglia di proiettori Claque è composta da diverse tipologie di lampade: sospensione, soffitto, incasso e su binario. Le sospensioni sono disponibili in diverse lunghezze. La versione a soffitto invece è disponibile sia come plafoniera fissa, sia come spot orientabile. Si tratta di lampade in alluminio bianco e nero, la cui sorgente luminosa è a LED. L'emissione della luce è diretta.

La gama de proyectores Claque está compuesta por varias tipologías de lámparas: lámparas colgantes, plafones, proyectores de empotrar y sobre guía. Las lámparas colgantes existen en varias longitudes. Sin embargo, la versión plafón se encuentra disponible como plafón fijo y orientable. Son lámparas de aluminio blanco y negro, con una fuente luminosa de LED. La emisión de la luz es directa.

Die Produktfamilie Claque umfasst verschiedene Strahlertypen: Hänge- und Deckenlampen, versenkte und auf Schienen laufende Leuchten. Die Hängelampen sind in verschiedenen Längen erhältlich. Die Ausführung als Deckenleuchte steht als stationärer oder als orientierbarer Strahler zur Verfügung. Es handelt sich um LED-Leuchten aus Aluminium. Die Beleuchtung ist direkt.

The Claque ceiling light collection comprises different types of lamps: hanging lamps, ceiling lamps, recessed lamps and track-mounted lamps. Hanging lamps are available in different lengths. The ceiling lamp is available as fixed light and as adjustable spot light. These black & white lamps have a LED light source. Direct light diffusion.

La famille des projecteurs Claque est composée par différentes typologies de lampes: suspensions, plafonniers, encastrables et sur rail. Les suspensions sont disponibles en différentes longueurs. La version plafonnier est disponible comme plafonnier fixe ou comme spot orientable. Il s'agit de lampes en aluminium blanc et noir, avec source lumineuse à LED. L'émission de la lumière est directe.

Семья ламп Claque состоит из различных видов ламп: подвесных, потолочных, встраиваемых и рельсовых. Подвески разной длины. Потолочная лампа имеется в двух вариантах: зафиксированный к потолку плафон или же вращаемый точечный свет. Выполнены из белого и черного алюминия, световой источник – светодиод. Прямое рассеивание света.





**CLAQUE**

Marc Sadler

*code*

*electrification*

*technical info*

*accessories*

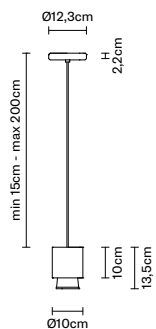

**NEW!** **F43 A01**  
**02 Black**

LED 220-240V  
1x20W-34°  
WHITE 3000K  
2000lm Cri 90

**EAC** IP40

INCLUDED:  
- LED / LED



LED

Dimmerabile TRIAC / Dimmable TRIAC

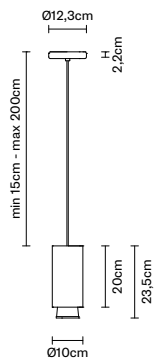

**NEW!** **F43 A03**  
**02 Black**

LED 220-240V  
1x20W-34°  
WHITE 3000K  
2000lm Cri 90

**EAC** IP40

INCLUDED:  
- LED / LED



LED

Dimmerabile TRIAC / Dimmable TRIAC

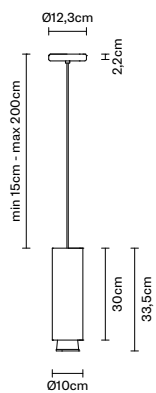

**NEW!** **F43 A05**  
**02 Black**

LED 220-240V  
1x20W-34°  
WHITE 3000K  
2000lm Cri 90

**EAC** IP40

INCLUDED:  
- LED / LED



LED

Dimmerabile TRIAC / Dimmable TRIAC



**CLAQUE**  
Marc Sadler

*code*

*electrification*

*technical info*

*accessories*

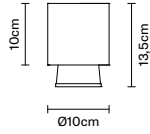

**NEW!** **F43 E01**  
**02 Black**

LED 220-240V  
1x20W-34°  
WHITE 3000K  
2000lm Cri 90

**EAC** IP40

INCLUDED:  
- LED / LED



Dimmerabile TRIAC / Dimmable TRIAC

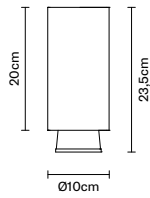

**NEW!** **F43 E03**  
**02 Black**

LED 220-240V  
1x20W-34°  
WHITE 3000K  
2000lm Cri 90

**EAC** IP40

INCLUDED:  
- LED / LED



Dimmerabile TRIAC / Dimmable TRIAC

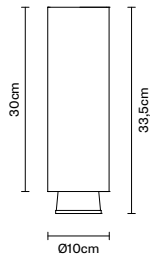

**NEW!** **F43 E05**  
**02 Black**

LED 220-240V  
1x20W-34°  
WHITE 3000K  
2000lm Cri 90

**EAC** IP40

INCLUDED:  
- LED / LED



Dimmerabile TRIAC / Dimmable TRIAC

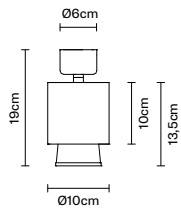

**NEW!** **F43 E07**  
**02 Black**

LED 220-240V  
1x20W-34°  
WHITE 3000K  
2000lm Cri 90

**EAC** IP40 35° ADJUSTABLE SYSTEM

INCLUDED:  
- LED / LED



Dimmerabile TRIAC / Dimmable TRIAC

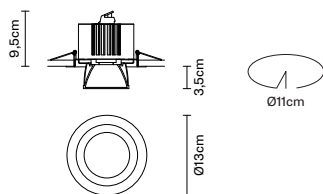

**NEW!** **F43 F01**  
**02 Black**

LED 220-240V  
1x20W-34°  
WHITE 3000K  
2000lm Cri 90

**EAC** IP40

INCLUDED:  
- LED / LED



Dimmerabile TRIAC / Dimmable TRIAC

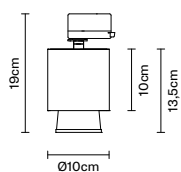

**NEW!** **F43 J01**  
**02 Black**

LED 220-240V  
1x20W-34°  
WHITE 3000K  
2000lm Cri 90

**EAC**  IP40

INCLUDED:  
- LED / LED



Dimmerabile TRIAC / Dimmable TRIAC

# CRICKET

—

Bridgewell Consulting LTD



La collezione si compone di apparecchi ad incasso per pavimento, parete e soffitto e da parete o soffitto, per interno ed esterno. Disponibili in diverse altezze, forme e dimensioni - anche ridottissime -, trovano soluzioni di montaggio pure in ambienti dove l'illuminazione serve dislocata rispetto al punto/i luce. Le strutture sono in alluminio lucido o anodizzato e cromo lucido. L'elettrificazione è a tensione di rete per lampade alogene, ioduri metallici e LED (500mA).

La colección está compuesta por aparatos empotrados de tierra, pared y techo y por apliques y plafones para interior y exterior. Disponibles en distintas alturas, formas y dimensiones - muy reducidas también - se pueden montar en lugares donde la iluminación está desplazada con respecto del/de los punto/s luz. Las estructuras son de aluminio brillo o anodizado y cromo brillante. La electrificación es con tensión de red para bombillas halógenas, ioduros metálicos y LED (500mA).

Die Kollektion besteht aus Einbauleuchten für Boden, Wand und Decken und Wand- oder Deckenleuchten für Innen- und Außenbereiche. In verschiedenen Höhen, Formen und Größen- auch sehr klein- erhältlich. Sie können in Räumen einfach montiert werden, wo die Beleuchtung von dem/den Lichtpunkt/en getrennt werden muss. Struktur aus glänzendem oder eloxiertem Stahl oder aus Glanzchrom. Elektrifizierung mit Netzspannung für Halogen- und Metalljodid- und LED-Lampen (500 mA).

The collection is made up of recessed lighting fixtures for the floor, wall and ceiling, and are suitable for indoor and outdoor use. They are available in various heights, shapes and sizes - even very small - and can also be installed in spaces where light is needed far from the light source. The casing is available in polished/anodized aluminium or polished chrome. The lamps run on mains power for halogen, metal halide and LED bulbs (500mA).

La collection se compose de systèmes d'éclairage encastrables pour sol, mur et plafond et d'appliques murales/plafonniers, pour l'intérieur et l'extérieur. Disponibles en différentes hauteurs, formes et dimensions - même très réduites -, ils disposent de solutions de montage même dans des pièces où l'illumination est décentrée par rapport au(x) point(s) de lumière. Les structures sont en aluminium poli ou anodisé et chrome poli. Lampes halogènes et ampoules iodures métalliques et LED (500 mA) alimentées par le tension du réseau.

Встраиваемые напольные, настенные и потолочные лампы, настенные и потолочные лампы, для внутренних помещений и для оформления открытых пространств. В наличии в разных высотах, формах и размерах, даже в самых маленьких, могут быть установлены там, где освещение должно быть отдалено от источника(ов) света. Структура из блестящего или анодированного алюминия или из блестящего хрома. Электрификация на сетевом напряжении с использованием галогенных, металлгалогенных и светодиодных ламп (500mA).





**CRICKET**  
Bridgewell Consulting LTD

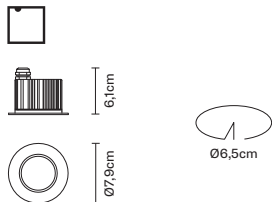

code	electrification	technical info	accessories
<b>D60 F15</b> 60 Warm white 3000K	LED 500mA 1x10W-10° WHITE 3000K 1000lm Cri >80	 0,003 m <sup>3</sup> 0,39 kg	INCLUDED: - LED / LED  NOT INCLUDED: - Alimentatore / Driver - Cassaforma / Housing

Uso parete/soffitto/terra / For wall/ceiling/floor

<b>D60 F16</b> 60 Warm white 3000K	LED 500mA 1x10W-40° WHITE 3000K 1000lm Cri >80	 0,003 m <sup>3</sup> 0,39 kg	INCLUDED: - LED / LED  NOT INCLUDED: - Alimentatore / Driver - Cassaforma / Housing
------------------------------------------	---------------------------------------------------------	-------------------------------------	----------------------------------------------------------------------------------------------------

Uso parete/soffitto/terra / For wall/ceiling/floor

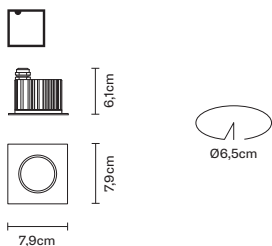

<b>D60 F19</b> 60 Warm white 3000K	LED 500mA 1x10W-10° WHITE 3000K 1000lm Cri >80	 0,003 m <sup>3</sup> 0,38 kg	INCLUDED: - LED / LED  NOT INCLUDED: - Alimentatore / Driver - Cassaforma / Housing
------------------------------------------	---------------------------------------------------------	-------------------------------------	----------------------------------------------------------------------------------------------------

Uso parete/soffitto/terra / For wall/ceiling/floor

<b>D60 F20</b> 60 Warm white 3000K	LED 500mA 1x10W-40° WHITE 3000K 1000lm Cri >80	 0,003 m <sup>3</sup> 0,16 kg	INCLUDED: - LED / LED  NOT INCLUDED: - Alimentatore / Driver - Cassaforma / Housing
------------------------------------------	---------------------------------------------------------	-------------------------------------	----------------------------------------------------------------------------------------------------

Uso parete/soffitto/terra / For wall/ceiling/floor

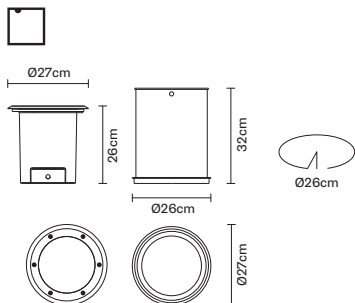

<b>D60 F30</b> 35 Polished stainless steel	E27 220-240V 1x75W HAGS	 0,064 m <sup>3</sup> 7,72 kg	INCLUDED: - Cassaforma / Housing  NOT INCLUDED: - Lampadina / Bulb
--------------------------------------------------	----------------------------	-------------------------------------	--------------------------------------------------------------------------------

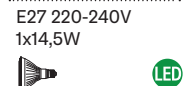

<b>D60 F31</b> 35 Polished stainless steel	G12 220-240V 1x70W MT	 0,064 m <sup>3</sup> 7,72 kg	INCLUDED: - Cassaforma / Housing - Trasformatore / Ballast  NOT INCLUDED: - Lampadina / Bulb
--------------------------------------------------	--------------------------	-------------------------------------	-------------------------------------------------------------------------------------------------------------



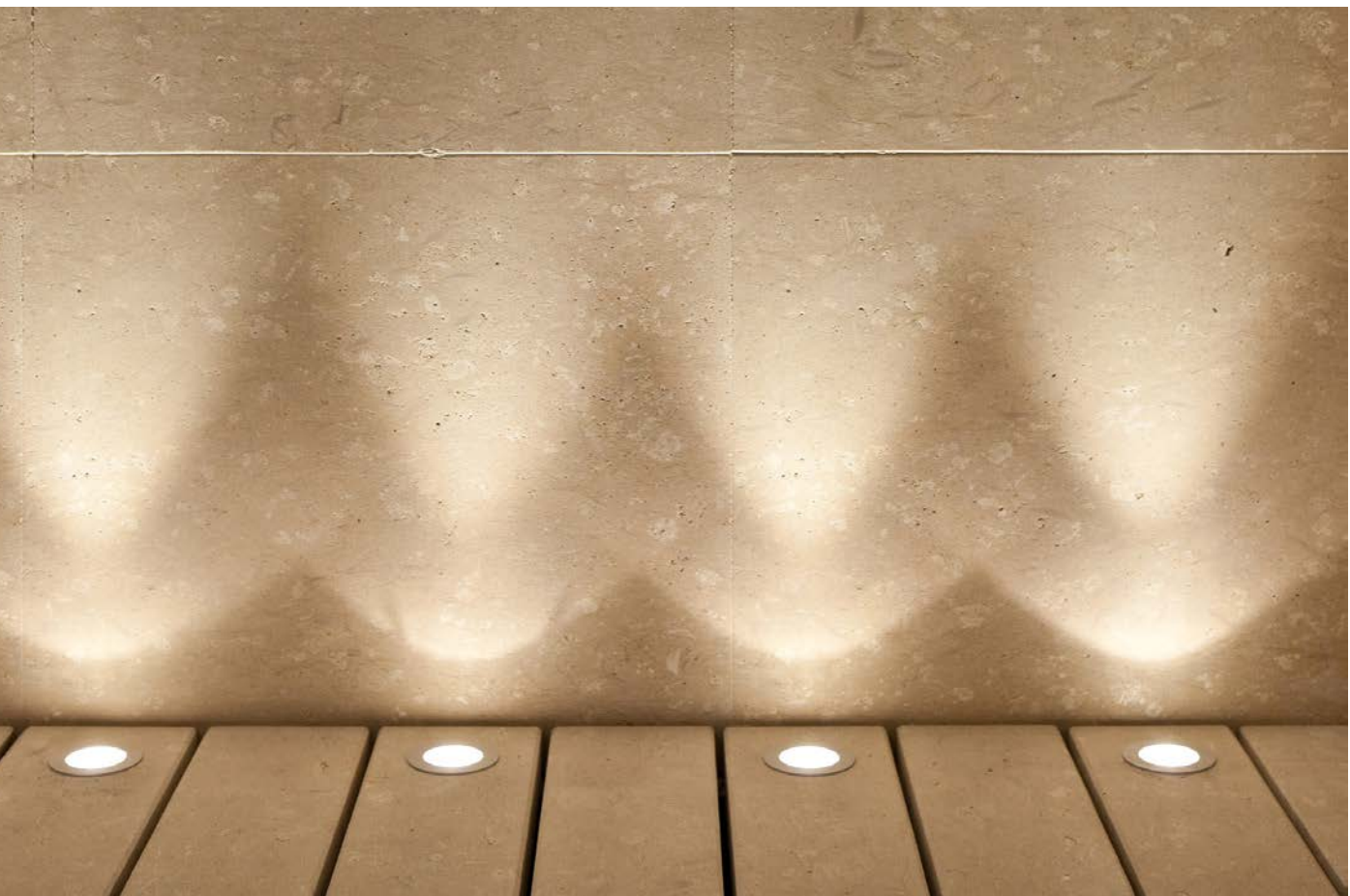



**CRICKET**

Bridgwell Consulting LTD

**code**

**electrification**

**technical info**

**accessories**

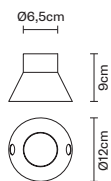

**D60 Z05**

**ERC**

0,005 m<sup>3</sup>  
0,13 kg

Cassaforma a pavimento. Per D60F15, D60F16, D60F19, D60F20 / Floor housing.  
For D60F15, D60F16, D60F19, D60F20

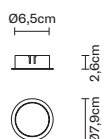

**D60 Z07**

**ERC**

0,003 m<sup>3</sup>  
0,09 kg

Cassaforma a parete/soffitto. Per D60F15, D60F16, D60F19, D60F20 / False ceiling ring. For D60F15, D60F16, D60F19, D60F20

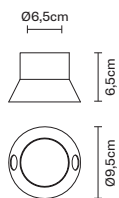

**D60 Z13**

**ERC**

0,003 m<sup>3</sup>  
0,10 kg

Cassaforma a pavimento. Per D60F15, D60F16, D60F19, D60F20 / Floor housing.  
For D60F15, D60F16, D60F19, D60F20

# PIVOT

—

Vittorio Massimo

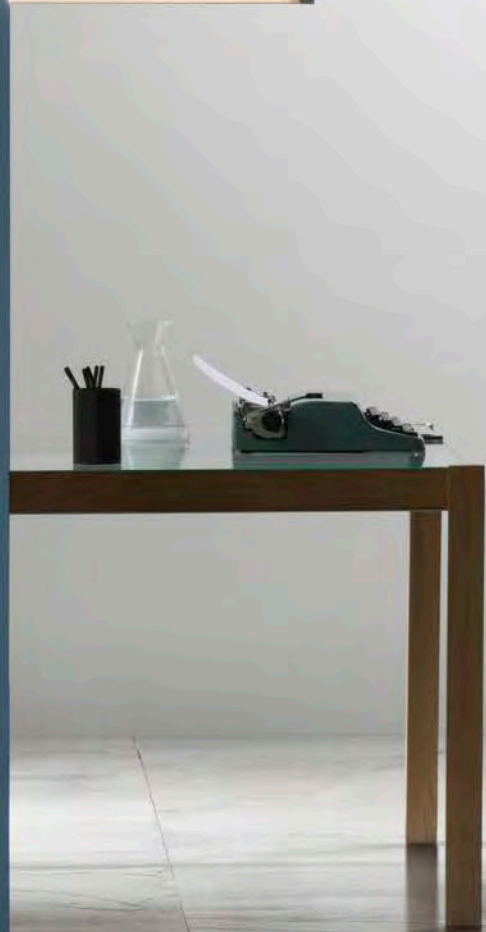
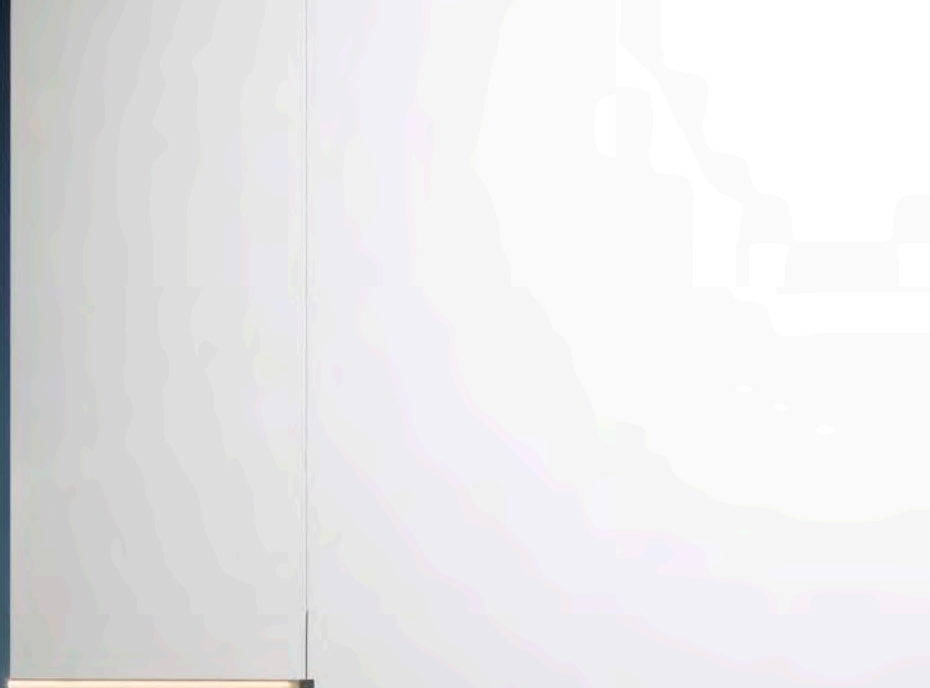
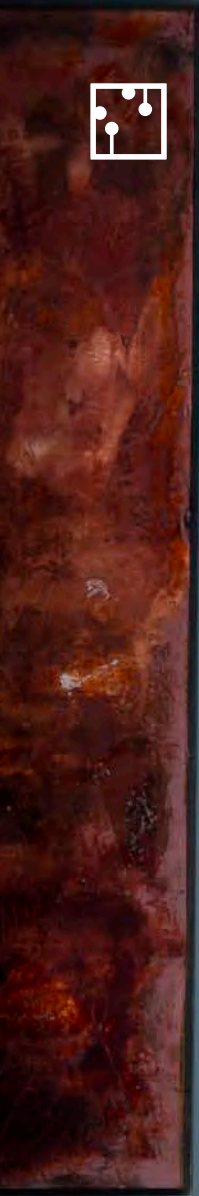

## CONCEPT

---

Come i fili d'erba crescono da terra e lì si ancorano decisi, così le sommità di questi si muovono libere al vento e in base alla direzione dell'aria si piegano e ruotano nello spazio. Pivot segue questa ispirazione e, da una base ben salda a terra, alza quattro elementi verticali che sono "pivotanti" rispetto al proprio asse e permettono di creare infinite sfaccettature di luce. La lampada, dunque, produce l'immagine di un semplice "rettangolo" che proietta un'illuminazione indiretta ma dinamica a muro. Pivot è un segno minimale capace di essere direzionato in base alle necessità, a seconda delle occasioni e dell'immaginazione.

Just as grass blades grow, firmly anchored down but still free to move in the direction of the wind, with a bending and turning movement, the Pivot lamp follows this theory, and has a solid base with four vertical elements that are flexible and allow the creation of infinite lighting facets. The lamp therefore produces a "rectangle" shape that projects an indirect, but dynamic illumination on the wall. Pivot is of minimalist design, and can to be pointed in the desired direction where needed.

Como los hilos de hierba crecen en el suelo donde se anclan con firmeza y sus puntas se mueven libres al viento y según la dirección del aire se pliegan y giran en el espacio. Pivot sigue esta inspiración y desde una base perfectamente fijada en el suelo, cuatro elementos verticales "pivotantes" se levantan respecto de sus ejes para crear infinitas facetas de luz. Por consiguiente, la lámpara produce la imagen de un simple "rectángulo", que proyecta una iluminación indirecta pero dinámica en la pared. Pivot es un signo minimalista que permite orientarse en función de las exigencias, las ocasiones y la imaginación.

Wie aus dem Boden wachsende Grasbüschel, die sich entschieden in ihm verwachsen und sich frei in der Richtung des Windes bewegen und im Raum biegen und drehen. Pivot verfolgt diese Inspiration und erstreckt aus einer am Boden gut befestigten Basis vier vertikale Elemente, die sich gegenüber ihrer Achse „drehen“ und so ermöglichen, unendliche Lichtfacettierungen zu erzeugen. Die Lampe erzeugt somit das Bild eines einfachen „Rechtecks“, das eine direkte aber dynamische Beleuchtung an der Wand projiziert. Pivot ist ein minimales Zeichen, das je nach Bedarf ausgerichtet wird, je nach Situation und Vorstellung.

Tels des brins d'herbes sortant de la terre et s'y accrochant avec force, leurs pointes se déplacent en toute liberté au vent et selon la direction de l'air en se pliant et en tournoyant dans l'espace. Pivot suit cette inspiration et, à partir d'une base bien plantée au sol, il lève quatre éléments verticaux "pivotants" par rapport à son axe, capable de créer des facettes de lumière infinies. La lampe produit donc l'image d'un simple "rectangle" projetant un éclairage indirect et dynamique sur le mur. Pivot est minimaliste et peut être orienté selon les besoins, les occasions et l'imagination.

Представьте себе молодые, но в то же время уже сильные побеги весенней травы, пробивающиеся из-под земли и свободно движущиеся вслед за дуновением легкого ветерка... Линейка светильников Pivot воплотила в себе вдохновение весенней картины: от прочного напольного основания поднимаются четыре вертикальных элемента, способных «поворачиваться» по отношению к плоскости, что позволяет создавать бесконечные грани света. Лампа производит образ обычного «прямоугольника», который проецирует на стену не прямой, но динамичный луч света. Pivot – это то минимум, который может использоваться согласно необходимости, случаю и воображению.

# PIVOT

---

La collezione Pivot comprende una lampada da terra, tre applique di diversa lunghezza per parete e soffitto e una sospensione, a richiesta le lunghezze sono personalizzabili. Le lampade sono state progettate per ambienti interni, disponibili in alluminio verniciato bianco, grigio antracite e grigio chiaro, la luce viene convogliata dalle barre luminose. Per la piantana, con alimentatore dimmerabile integrato, e per la sospensione, l'elettrificazione è a tensione di rete per LED. Per le lampade da parete e da soffitto, l'elettrificazione è a bassa tensione (24Vdc a LED) con alimentatore remoto.

La colección Pivot comprende una lámpara de pie y tres apliques con distintas medidas de largo para paredes y techos y una lámpara colgante; bajo pedido las medidas de largo se pueden personalizar. Las lámparas se han diseñado para ambientes internos, disponibles en aluminio pintado de color blanco o gris antracita y gris claro; la luz se transmite por las barras luminosas. Para la lámpara de pie, con alimentador integrado regulable en intensidad y para la lámpara colgante, la electrificación es con tensión de red para LED. Para los apliques y plafones, la electrificación es de baja tensión (24Vcc con LED) con alimentador a distancia.

Die Kollektion Pivot schließt eine Bodenlampe und drei Wandlampen unterschiedlicher Länge für die Wand und Decke sowie eine Hängelampe ein; auf Wunsch sind die Längen individuell gestaltbar. Die Lampen wurden für Innenbereiche entwickelt und sind aus weiß oder anthrazit- oder hellgrau lackiertem Alu erhältlich, das Licht wird von den Leuchtstangen geleitet. In der Bodenlampe mit einem integrierten dimmerbaren Netzteil und für die Hängelampe erfolgt die Elektrifizierung per Netzstrom für LED. Bei den Wand- und Deckenlampen erfolgt die Elektrifizierung per Niederspannung (24 V mit LED) mit distanzierterm Netzteil.

The Pivot collection is made up of a floor lamp, and three wall and ceiling appliques in various sizes, plus one hanging lamp. All lengths can be completely customized on request. The lamps are designed for indoor use, and are available in white, dark grey or light grey aluminium, the light is directed through the light bars. For the floor lamp, which has a built-in dimmer switch, and for the hanging lamp, the energy voltage is LED, while for the wall and ceiling lamp, the energy voltage is low (24V dc, LED) and comes with a remote power pack.

La collection Pivot se compose d'une lampe sur pied et de trois appliques de différentes longueurs pour mur et plafond mais aussi d'une lampe suspension. Les longueurs sont personnalisables sur demande. Ces luminaires ont été conçus pour l'intérieur. Ils sont proposés en aluminium peint en blanc, gris anthracite ou gris clair. La lumière est dirigée par des barres lumineuses. Concernant la lampe sur pied, avec variateur de lumière intégré, et la suspension, l'électrification est à la tension de réseau pour des ampoules à LED. Quant aux appliques et aux plafonniers, l'électrification est à basse tension (24Vdc à LED) et le ballast à distance.

Коллекция Pivot для внутреннего освещения помещения включает в себя напольный светильник, три бра различной длины для размещения на стене и на потолке и подвесной светильник; длина бра может быть изменена по заказу клиента. Светильники предназначены для интерьеров и выполнены из алюминия белого цвета, оттенка серого антрацита и светло-серого цвета. Свет подается через светящиеся стержни. Цоколь торшера и подвесного светильника оснащен встроенным блоком питания с регулятором яркости и предназначен для светодиодов (LED). У бра и люстры цоколь предназначен для ламп низкого напряжения (24V для светодиодов) с удаленным блоком питания.

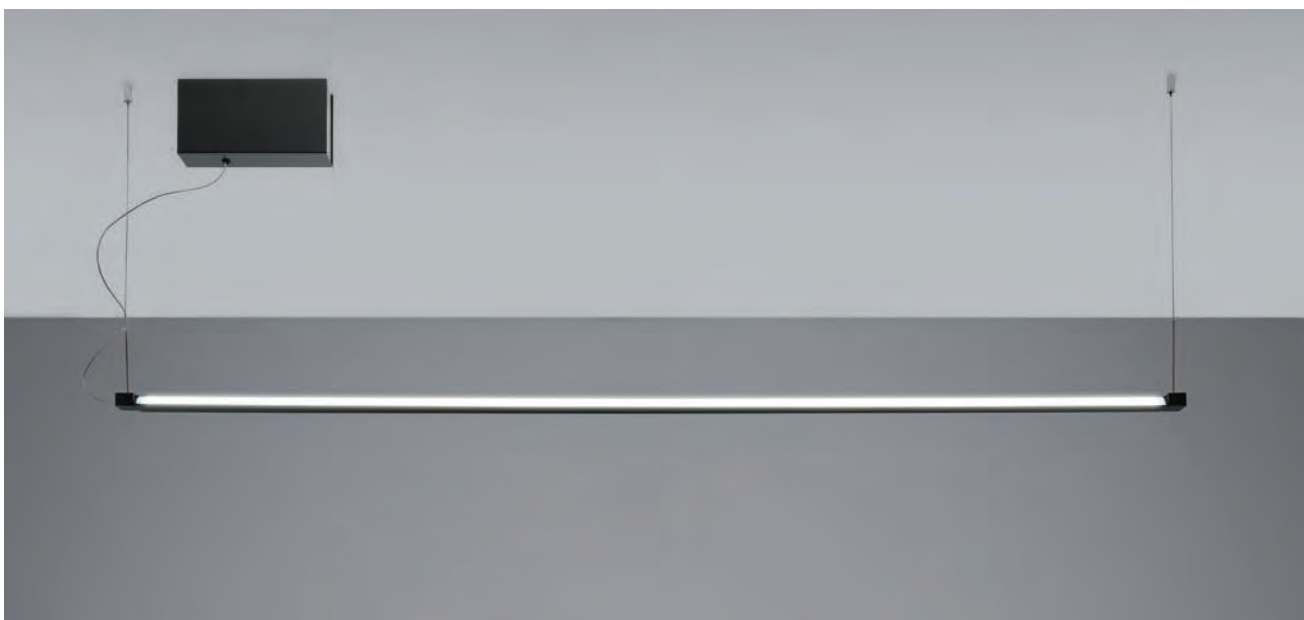

**PIVOT**  
Vittorio Massimo

*code*

*electrification*

*technical info*

*accessories*

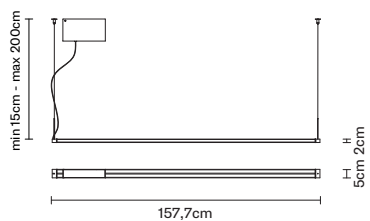

**F39 A01**  
01 White  
21 Anthracite  
75 Light grey

LED 220-240V  
1x90W-120°  
WHITE 3000K  
7500lm CRI >80

**EAC** IP40



INCLUDED:

- LED / LED
- Alimentatore elettronico / Electronic driver

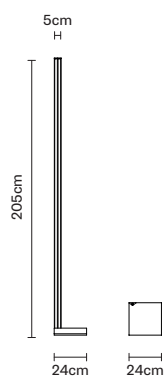

**F39 C01**  
01 White  
21 Anthracite  
75 Light grey

LED 220-240V  
1x120W-120°  
WHITE 3000K  
10000lm CRI >80

**EAC** IP40



INCLUDED:

- LED / LED
- Alimentatore elettronico dimmerabile / Dimmable electronic driver





**PIVOT**

Vittorio Massimo

*code*

*electrification*

*technical info*

*accessories*

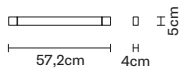

**F39 G01**  
**01 White**  
**21 Anthracite**  
**75 Light grey**

LED 24Vdc  
 1x30W-120°  
 WHITE 3000K  
 2500lm Cri >80

**EAC** III IP40  
 0,007 m<sup>3</sup>  
 0,60 kg

INCLUDED:  
 - LED / LED  
 NOT INCLUDED:  
 - Alimentatore / Driver

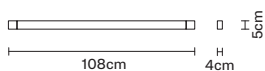

**F39 G03**  
**01 White**  
**21 Anthracite**  
**75 Light grey**

LED 24Vdc  
 1x60W-120°  
 WHITE 3000K  
 5000lm Cri >80

**EAC** III IP40  
 360°  
 ADJUSTABLE SYSTEM  
 0,016 m<sup>3</sup>  
 1,58 kg

INCLUDED:  
 - LED / LED  
 NOT INCLUDED:  
 - Alimentatore / Driver

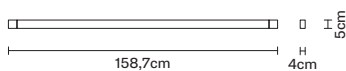

**F39 G05**  
**01 White**  
**21 Anthracite**  
**75 Light grey**

LED 24Vdc  
 1x90W-120°  
 WHITE 3000K  
 7500lm Cri >80

**EAC** III IP40  
 360°  
 ADJUSTABLE SYSTEM  
 0,012 m<sup>3</sup>  
 1,86 kg

INCLUDED:  
 - LED / LED  
 NOT INCLUDED:  
 - Alimentatore / Driver



# PUÀ

—

Pellegrini+Mengato Design

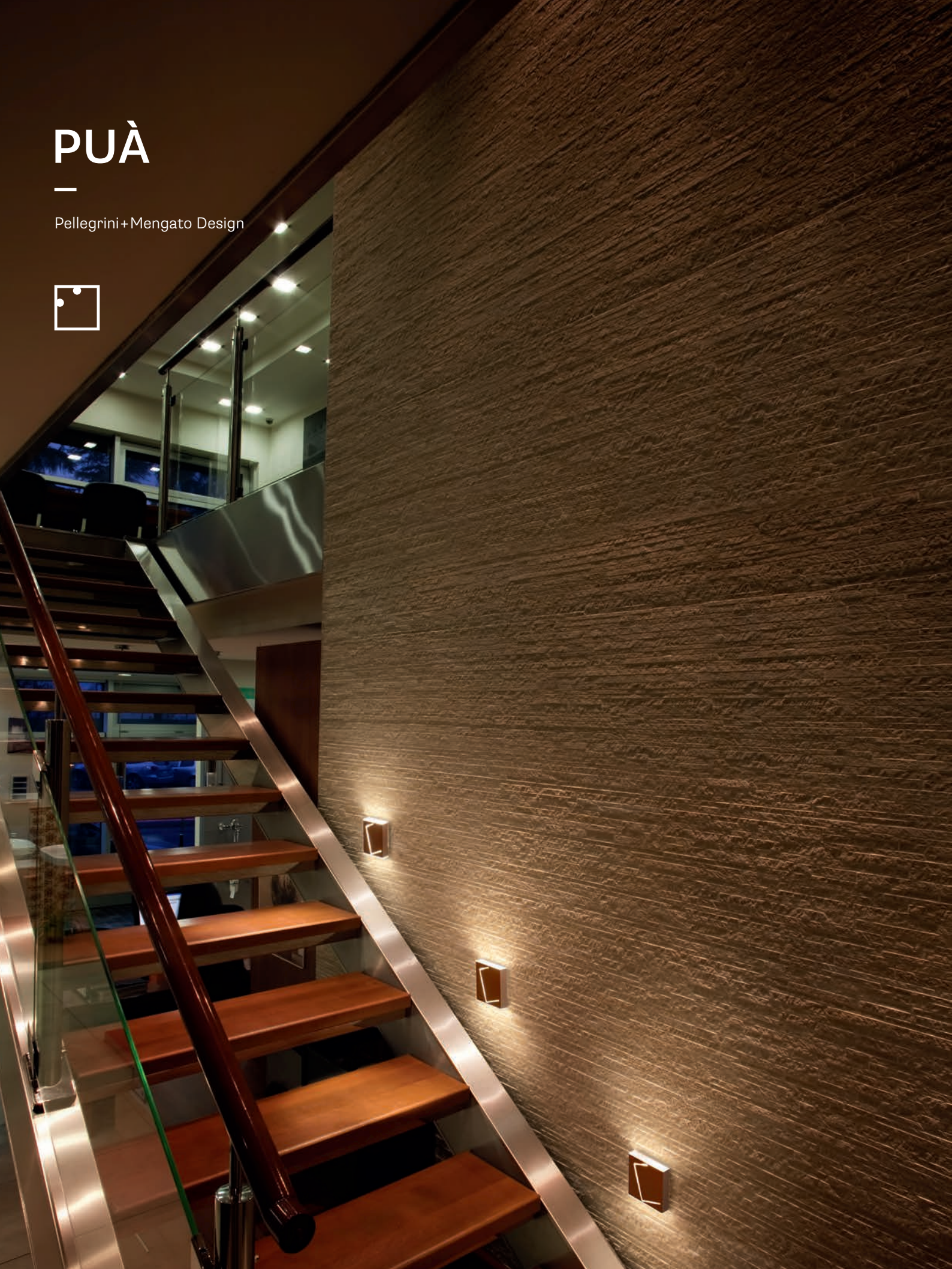



## CONCEPT

---

**Tecnicamente semplice e formale: questo è il concept da cui nasce Puà, la collezione di segnapassi firmata Pellegrini+Mengato Design. La struttura è costituita da un piccolo involucro dai cui lati fuoriescono due “pennellate” di luce; un taglio frontale asimmetrico ne arricchisce il design, creando un segno luminoso definito. Puà non è solo un segnapassi di cortesia, bensì un oggetto che impreziosisce l’ambiente in cui è inserito: è la soluzione ideale per illuminare raso terra un corridoio d’ingresso, un soggiorno o i gradini di una scala ma può essere anche usato come applique per illuminare in modo discreto ed elegante gli ambienti di servizio.**

Technical simplicity and formality, is the concept behind Puà, the collection of spotlights by Pellegrini+Mengato Design. The structure is made from a small encasement from which two strokes of light escape. An asymmetric cut on the front enriches this design creating a definite lighting point. Puà is not only a spotlight, but an object that enriches any room where it is needed. It is the ideal solution for illuminating a corridor or hallway, a lounge or staircases, and it can be used as an applique to light up living areas in a discreet, yet elegant fashion.

Técnicamente sencillo y formal: éste es el concepto de donde nace Puà, la colección de lámparas empotrables de suelo firmada por Pellegrini+Mengato Design. La estructura está constituida por una pequeña envoltura de cuyos lados salen dos “pinceladas” de luz; un corte frontal asimétrico enriquece su diseño al crear un signo luminoso definido. Puà no es solamente una lámpara empotrable de suelo de cortesia sino un objeto que embellece el ambiente en su alrededor: es la solución ideal para iluminar a ras del suelo pasillos de entrada, salas de estar o peldaños de una escalera aunque se puede usar también como un aplique para iluminar de una forma discreta y elegante los ambientes de servicio.

Technisch einfach und formal: Das ist das Konzept von Puà, die Gangbeleuchtungskollektion von Pellegrini+Mengato Design. Die Struktur besteht aus einer kleinen Umhüllung, aus deren Seiten zwei Lichtbündel hervorgehen; ein frontaler asymmetrischer Schnitt bereichert das Design und kreiert ein definiertes Lichtzeichen. Puà ist nicht nur eine unterstützende Gangbeleuchtung, sondern auch ein Gegenstand, der die Umgebung aufwertet: Die ideale Lösung zur Beleuchtung des Bodens eines Korridors, eines Wohnzimmers oder der Stufen einer Treppe, sie kann aber auch als Wandlampe zur diskreten und eleganten Beleuchtung von Nebenräumen verwendet werden.

Techniquement simple et formel: il s’agit du concept d’où provient Puà, la collection de sentiers lumineux signée par Pellegrini+Mengato Design. La structure se compose d’une petite enveloppe dont les côtés laissent s’échapper deux “coups de pinceau” de lumière; une coupe frontale asymétrique enrichit le design, en créant ainsi un faisceau lumineux défini. Puà représente un sentier lumineux d’accueil mais elle représente aussi un objet qui décore l’environnement d’installation: elle est la solution idéale pour éclairer le sol d’un couloir d’entrée, d’une salle à manger ou les marches d’un escalier. Elle peut également être utilisée en guise d’applique pour éclairer de façon élégante et en toute discrétion les lieux de service.

Простота техники и точность – вот концепция, благодаря которой родилась коллекция встроенных светильников для пола и лестниц Puà – шедевр совместной работы Pellegrini и Mengato Design. Светильник представляет собой небольшую оболочку, из которой «вытекают» два световых «штриха»; ассиметричный разрез фронтальной части светильника делает его дизайн оригинальным и задает определенную форму светового потока. Puà – это не просто встраиваемые светильники, это деталь, украшающая помещение: идеальное решение для мягкого освещения пола прихожей, зала или лестничных ступеней. Вместе с тем светильники могут быть встроены в стену для сдержанного и элегантного освещения ванной комнаты.

# PUÀ

—

La collezione Puà si compone da un'appliche disponibile in una sola dimensione in bianco, nero e brunito satinato, da installare in ambienti interni. Il corpo illuminante è in alluminio verniciato, la luce viene diffusa dal taglio frontale e dai lati attraverso due diffusori in policarbonato. L'elettrificazione è a tensione di rete per LED.

La colección Puà está compuesta por un aplique disponible en un único tamaño de color blanco, negro o bruñido satinado para instalar en ambientes internos. El cuerpo de iluminación es de aluminio pintado, la luz se difunde por el corte frontal y por los lados mediante dos difusores de policarbonato. La electrificación es con tensión de red para Led.

Die Kollektion Puà besteht aus einer Wandlampe in nur einer Abmessung, in Weiß oder schwarz und satiniert brüniert, und ist für Innenbereiche gedacht. Der Leuchtkörper besteht aus lackiertem Aluminium, das Licht wird durch den frontalen Einschnitt und die Seiten durch zwei Polycarbonat-Diffusoren verbreitet. Die Elektrifizierung erfolgt über Netzspannung bei LED-Lampen.

The Puà collection is made up of an applique, available in one size only, in white, black or a satin burnished finish, suitable for indoor use. The shade is in lacquered aluminium and the light is diffused from the cut at the front and from the sides through two polycarbonate diffusers. The energy voltage is LED.

La collection Puà se compose d'une applique, proposée en une seule dimension, en blanc, noir et brun satiné pour les intérieurs. Le corps d'éclairage est en aluminium peint. La lumière est diffusée par la coupe frontale et par les côtés à travers deux diffuseurs en polycarbonate. L'électrification est à la tension de réseau pour ampoules à LED.

Коллекцию Puà представляют встраиваемые светильники одного размера белого цвета, оттенка черный, а также из тонированного сатинированного стекла для внутреннего освещения помещений. Арматура выполнена из окрашенного алюминия, свет подается из фронтального разреза и двух боковых рассеивателей, изготовленных из поликарбоната. Цоколь предназначен для светодиода (LED).

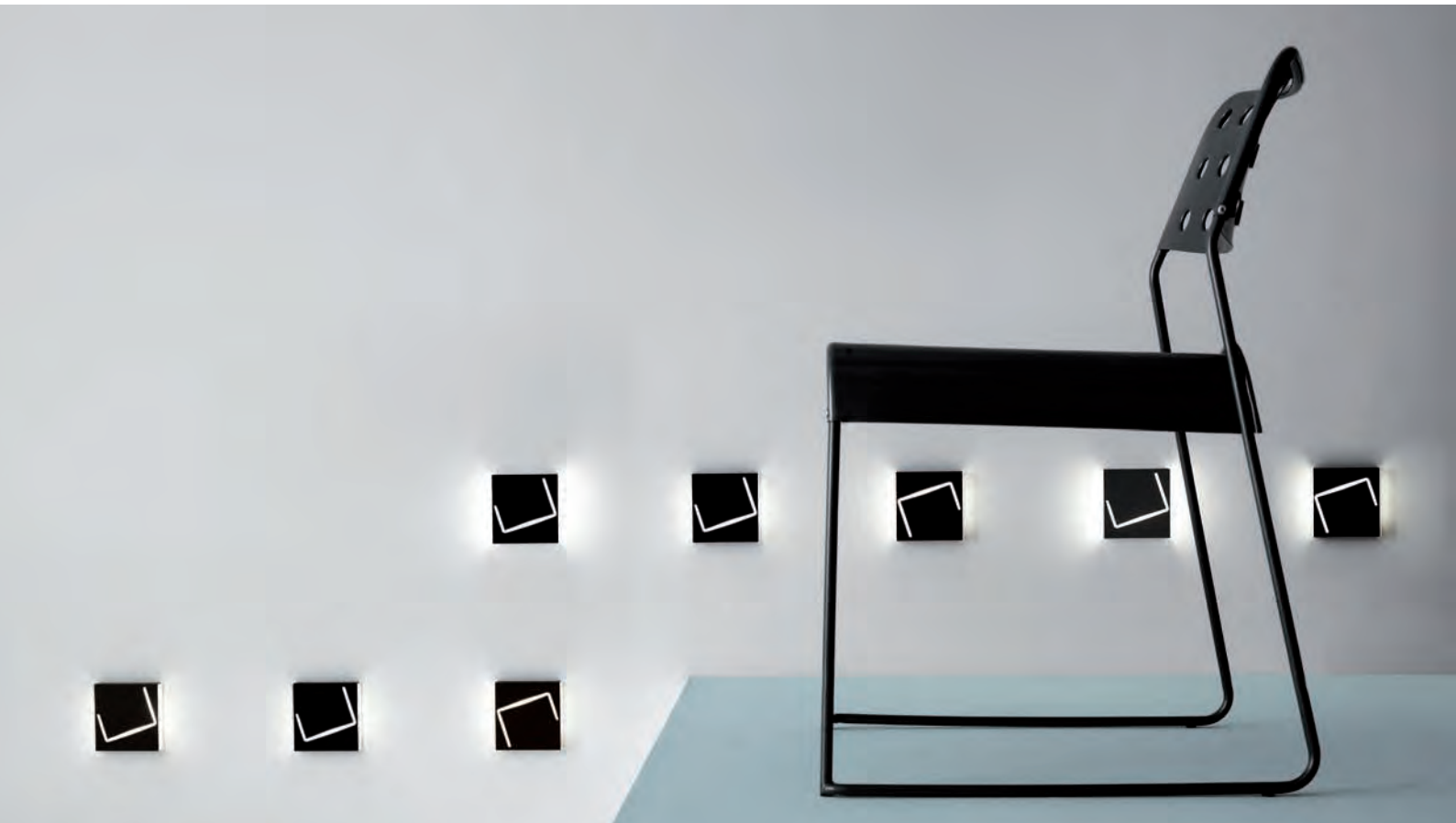

**PUÀ**

Pellegrini+Mengato Design

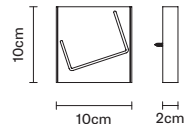

**code**

**electrification**

**technical info**

**accessories**

**F37 G01**

**01 White**

**02 Black**

**14 Satin-finish  
burnished**

LED 220-240V  
1x4.5W-120°  
WHITE 2700K  
400lm Cri >80



**EAC** IP20

0,002 m<sup>3</sup>  
0,15 kg



INCLUDED:  
- LED / LED

Dimmerabile TRIAC / Dimmable TRIAC



# QUADRILED

—

Marc Sadler

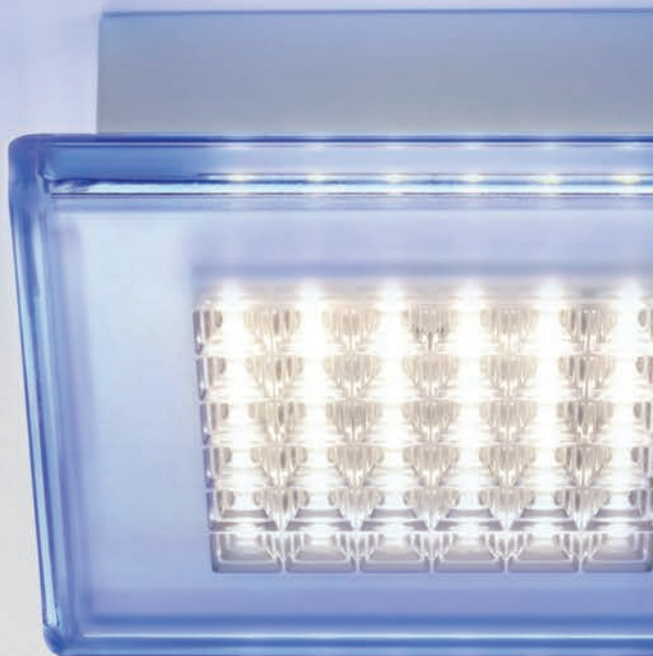





## CONCEPT

---

Di Marc Sadler, è un corpo illuminante ricco, finemente lavorato, che relega definitivamente in soffitta ogni preconcetto verso la presunta freddezza dei led. Il modulo trasparente sfaccettato coniuga il sapore del cristallo di Murano con la più moderna tecnica di lavorazione dei polimeri. Questo corpo illuminante garantisce ottime prestazioni energetiche, grazie alla presenza di 36 luci led dall'eccellente resa luminosa con un consumo di soli 15W. L'eventuale tocco di colore dei bordi non altera l'intensità e la qualità della luce, che resta calda e avvolgente.

This Marc Sadler lamp is finely finished and manufactured, and once and for all eliminates any prejudice concerning the alleged coldness of LED lights. The faceted transparent module combines a taste for Murano glass with the very latest polymer processing techniques. This ensures top energy-saving performance thanks to 36 LED lights with an excellent luminous efficacy and a consumption of just 15W. Any colour touches around the edges do not change the intensity and quality of the light, which remains warm and cosy.

De Marc Sadler, es un cuerpo de luz rico, tratado finamente, que despeja todas las dudas sobre la presunta frialdad de los leds. El módulo transparente de varias facetas conjuga el sabor del cristal de Murano con la técnica de tratamiento más moderna de los polímeros. Este cuerpo de luz asegura óptimas prestaciones energéticas mediante sus 36 luces led con un rendimiento luminoso excelente y un consumo de solamente 15 W. El toque de color en los bordes no altera la intensidad ni la calidad de la luz que sigue siendo cálida y envolvente.

Der prachtvoll, fein gearbeitete Beleuchtungskörper von Marc Sadler widerlegt alle Vorurteile bezüglich der angeblichen Kälte von LED-Lampen. Das transparente, facettierte Modul vereinigt geschmackvolles Murano Kristall mit den modernsten Techniken zur Bearbeitung des Polymers. Dieser Beleuchtungskörper garantiert zudem eine optimale Energieleistung durch die Anzahl von 36 LED-Lampen mit exzellenter Lichterzeugung bei einem Verbrauch von nur 15 W. Der eventuelle Farb-Touch an den Rändern hat keinen Einfluss auf die Intensität des Lichts, die alle Räume in ein unverändert warmes und sanftes Licht hüllt.

Ce corps d'éclairage riche, finement élaboré, dessiné par Marc Sadler, bannit à jamais l'idée préconçue la froideur de l'éclairage à LED. Le module transparent facetté allie le charme du verre de Murano avec la technique de travail des polymères la plus moderne. Ce corps d'éclairage garantit d'excellentes performances énergétiques, grâce à la présence de 36 LED qui offrent un excellent rendu lumineux avec une consommation de seulement 15W. L'éventuelle touche de couleur des bords n'altère pas l'intensité et la qualité de la lumière qui reste chaude et enveloppante.

Автор Марк Садлер создал богатый световой корпус с тонкой обработкой, который навсегда отправляет на чердак любую концепцию холодности светодиодов. Прозрачный граненый модуль сочетает в себе вкус к венецианскому стеклу с самой современной технологией переработки полимеров. Этот световой прибор гарантирует прекрасную энергоэффективность, благодаря 36 светодиодам с великолепным световым потоком при потреблении всего 15 Вт. Легкая окраска по краю не влияет на интенсивность и качество света, который остается теплым и обволакивающим.

# QUADRILED

La collezione è costituita da lampade ad incasso e da parete e soffitto per interno. Il diffusore è in policarbonato trasparente, declinato in quattro varianti di colore: trasparente, con profili ambra, rossi o blu. L'incasso ha struttura in alluminio lucido, la versione da parete e soffitto è a vista verniciata grigia. L'elettrificazione è a bassa tensione (24Vdc) per LED.

La colección está constituida por focos, apliques y plafones de interior. El difusor es de policarbonato transparente en cuatro variantes de color: transparente, con bordes ámbar, rojos o azules. El foco presenta una estructura de aluminio brillante y las versiones aplique y plafón están pintadas de color gris. La electrificación es con baja tensión (24Vcc) para LED.

Die Kollektion besteht aus Einbauleuchten für die Decke und Wand für Innenbereiche. Der Diffusor besteht aus transparentem Polykarbonat und präsentiert sich in vier Farbvarianten: Transparent, mit bernsteinfarbenem Profil, rot oder blau. Das Einbauteil ist aus Glanzalu, die Wand- und Deckenausführung ist aus sichtbarem Graulack. Die Elektrifizierung erfolgt über Niederspannung (24 Vdc) für LED.

The collection is made up of recessed lights, wall and ceiling lamps for indoor use. The diffuser is in transparent polycarbonate and is available in four different colours: fully transparent, transparent with amber edges, red or blue. The recessed version has a polished aluminium structure while the wall and ceiling lamps are painted in grey. The lamp runs on a low voltage (24Vdc) and suitable for use with LED bulbs.

La collection est constituée de lampes à encastrer et d'appliques murales et de plafonniers pour intérieur. Le diffuseur est en polycarbonate transparent, avec des profilés de couleur ambre, rouge ou bleu. La structure de l'encastrement est en aluminium poli et est apparente en gris pour la version murale et le plafonnier. LED alimentées en basse tension (24Vdc).

Коллекция состоит из встраиваемых настенных и потолочных светильников для внутренних помещений. Рассеиватель изготовлен из прозрачного поликарбоната, в четырех цветовых вариантах: прозрачный, с янтарными, красными или синими профилями. Встраиваемая часть имеет структуру из алюминия, наружная структура настенных и потолочных светильников окрашена серым лаком. Электрическая часть рассчитана на светодиодные лампы при низком напряжении (24V постоянного тока).

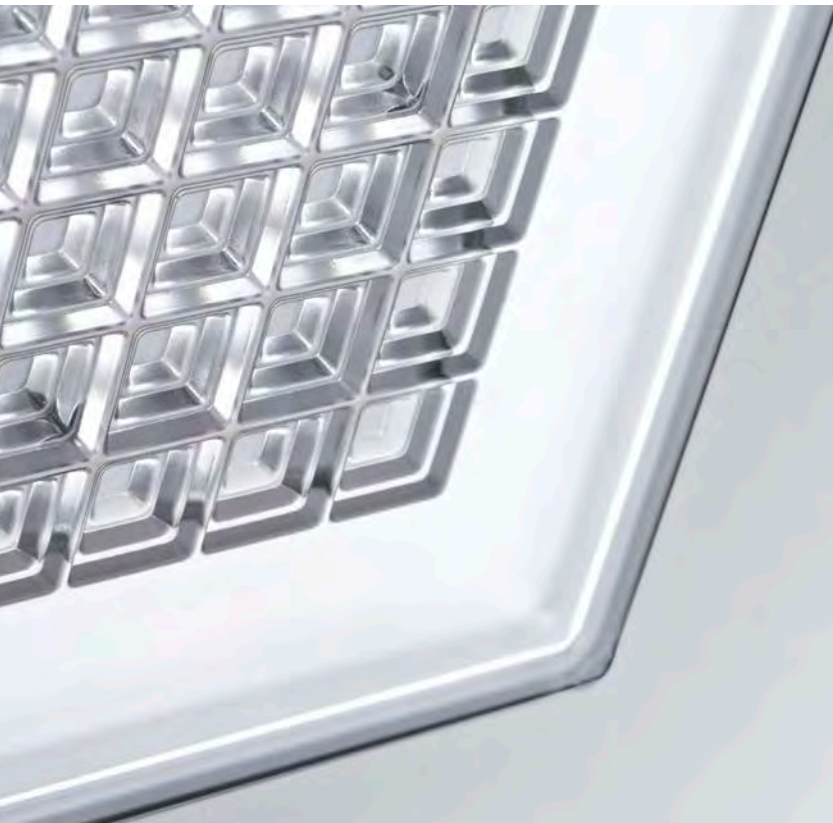



**QUADRILED**  
Marc Sadler

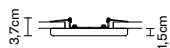
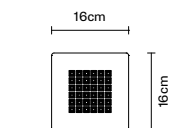

**code**                      **electrification**                      **technical info**                      **accessories**

**F18 F01**  
**00 Transparent**

LED 24Vdc  
1x15W-120°  
WHITE 3000K  
660lm Cri >80  
≈

**ERC** IP44  
0,005 m<sup>3</sup>  
0,48 kg

INCLUDED:  
- LED / LED  
  
NOT INCLUDED:  
- Trasformatore elettronico / *Electronic transformer*

**F18 F02**  
**03 Red**  
**05 Aquamarine**  
**47 Amber**

LED 24Vdc  
1x15W-120°  
WHITE 3000K  
660lm Cri >80  
≈

**ERC** IP44  
0,005 m<sup>3</sup>  
0,49 kg

INCLUDED:  
- LED / LED  
  
NOT INCLUDED:  
- Trasformatore elettronico / *Electronic transformer*

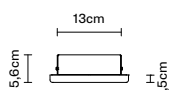
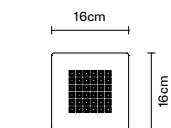

**F18 G01**  
**00 Transparent**

LED 220-240V  
1x15W-120°  
WHITE 3000K  
660lm Cri >80  
≈

**ERC** IP40  
0,005 m<sup>3</sup>  
1,06 kg

INCLUDED:  
- LED / LED  
- Trasformatore elettronico / *Electronic transformer*

**F18 G02**  
**03 Red**  
**05 Aquamarine**  
**47 Amber**

LED 220-240V  
1x15W-120°  
WHITE 3000K  
660lm Cri >80  
≈

**ERC** IP40  
0,005 m<sup>3</sup>  
1,05 kg

INCLUDED:  
- LED / LED  
- Trasformatore elettronico / *Electronic transformer*



# QUARTER

Pellegrini+Mengato Design



# CONCEPT

---

Come accade a un disegno in un foglio vuoto, gli elementi luminosi di Quarter prendono forma e movimento all'interno di un sottile strato di alluminio bianco. È la luce ad essere protagonista: viene convogliata all'interno di piccoli cubi in polycarbonato che danno l'illusione di essere stati disegnati direttamente sul soffitto. La sua peculiarità sta nella possibilità di essere impiegata in diversi ambienti: è infatti perfetta per dare spessore e movimento in realizzazioni residenziali ma allo stesso tempo il suo design la rende adatta anche ad un impiego in ambienti contract.

Just like a design that has yet to take shape on a blank page, the lighting elements of Quarter take form and movement inside a thin layer of white aluminium. Light plays the leading role; it is directed to the inside of small polycarbonate cubes, that give the illusion of being painted directly onto the ceiling. The beauty of this lamp is the fact that it can be used in different environments and is perfect to give depth and movement to the home, but at the same time its design makes it just as suitable for offices.

Como sucede a un dibujo en un folio vacío, los elementos luminosos de Quarter cobran forma y movimiento internamente en una capa fina de aluminio blanco. La luz es la protagonista: es transportada en el interior de pequeños cubos de polycarbonato, que crean la ilusión de estar dibujados directamente en el techo. Su peculiaridad reside en la opción de poder emplearse en varios ambientes: resulta perfecta para dar transcendencia y movimiento en realizaciones residenciales aunque al mismo tiempo por su diseño es idónea también para el uso en ambientes contract.

Wie es mit einer Zeichnung auf einem leeren Blatt geschieht, so erhalten die Leuchtelemente von Quarter ihre Form und Bewegung innerhalb einer dünnen Schicht aus weißem Aluminium. Das Licht ist der Protagonist: Es wird innerhalb kleiner Polycarbonatwürfel geleitet, die den Eindruck erwecken, direkt an der Decke gezeichnet zu sein. Ihre Besonderheit liegt in der Möglichkeit, in verschiedenen Umgebungen angewendet zu werden: Sie ist perfekt, um Bedeutung und Bewegung in Wohnumgebungen zu bringen, ihr Design gestaltet sie aber auch gleichzeitig ideal für eine Anwendung in Contract-Umgebungen.

Comme un dessin sur une feuille vide, les éléments lumineux de Quarter prennent forme et mouvement à l'intérieur d'une fine couche d'aluminium blanche. La lumière devient protagoniste: elle est dirigée à l'intérieur de petits cubes en polycarbonate en donnant l'illusion d'avoir été directement dessinés au plafond. Elle est particulière car elle peut être employée dans différents environnements: elle est en effet parfaite pour donner de la consistance et du mouvement dans des réalisations résidentielles. Elle est également adaptée aux environnements contracts.

Световые элементы светильников линии Quarter «рождаются» под тонким слоем белого алюминия. Светильники Quarter по достоинству могут быть названы «главными героями» помещения: свет подается из маленьких поликарбонатных кубиков, которые кажутся нарисованными прямо на потолке. Уникальность линейки Quarter заключается в использовании светильников в самых разных помещениях: коллекция может воссоздать глубину и движение света в жилых домах, а может стать и элегантным элементом дизайна делового центра.

# QUARTER

La collezione Quarter è costituita da lampade a parete e soffitto per interno, disponibili in sette diverse dimensioni, e da due sospensioni per interno. Il corpo illuminante è in alluminio bianco verniciato, nero verniciato e brunito satinato, la luce viene diffusa dai piccoli cubi in policarbonato. L'elettrificazione è a tensione di rete per LED.

La colección Quarter está constituida por apliques y plafones de interior, disponibles en siete tamaños distintos, y por dos lámparas colgantes de interior. El cuerpo de iluminación es de aluminio blanco pintado, negro pintado y bruñido satinado, la luz se difunde mediante pequeños cubos de policarbonato. La electrificación es con tensión de red para Led.

Die Kollektion Quarter besteht aus Wand- und Deckenlampen für Innenbereiche und ist in sieben verschiedenen Abmessungen erhältlich; ebenso werden zwei Hängelampen für Innenbereiche angeboten. Der Leuchtkörper besteht aus weiß oder schwarz lackiertem Alu und satiniert brüniert, das Licht wird von den kleinen Polycarbonat-Würfeln verbreitet. Die Elektrifizierung erfolgt über Netzspannung bei LED-Lampen.

The Quarter collection is made up of indoor wall and ceiling lamps, available in seven different sizes, plus two hanging lamps, also for indoor use. The shade is in white or black lacquered aluminum, or aluminum with a satin-brushed finish and the light is diffused through small polycarbonate cubes. The energy voltage is LED.

La collection Quarter se compose d'appliques/plafonniers pour l'intérieur. Elle est proposée dans sept dimensions différentes. Cette collection est complétée par deux suspensions d'intérieur. Le corps d'éclairage est peint couleur aluminium, noir et brun satiné. Sa lumière est diffusée grâce aux petits cubes en polycarbonate. L'électrification est à la tension de réseau pour ampoules à LED.

Коллекция Quarter представлена настенными и потолочными лампами семи размеров и двумя подвесными светильниками для интерьеров. Арматура изготовлена из алюминия белого, черного лакированного и воронено-сатинированного цветов. Свет рассеивается из маленьких кубов, выполненных из поликарбоната. Цоколь предназначен для светодиода (LED).



**QUARTER**

Pellegrini+Mengato Design

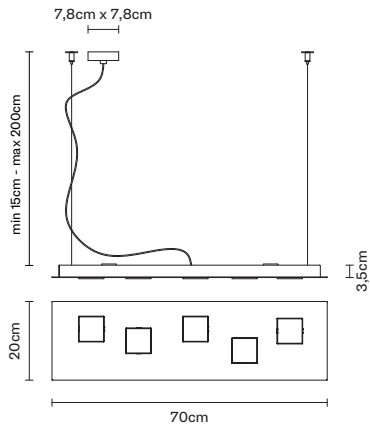

**code**

**electrification**

**technical info**

**accessories**

**F38 A01**

**01 White**

**02 Black**

**14 Satin-finish  
burnished**

LED 220-240V  
2x4.5W-120°  
WHITE 2700K  
800lm CRI >80



INCLUDED:  
- LED / LED

LED 220-240V  
5x4.5W-120°  
WHITE 2700K  
2000lm CRI >80



Dimmerabile TRIAC. Luce diretta e indiretta / *Dimmable TRIAC. Direct and indirect light*

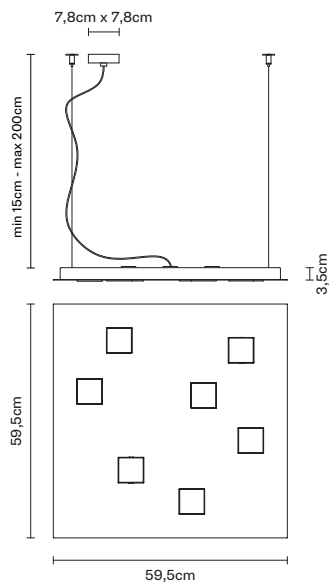

**F38 A03**

**01 White**

**02 Black**

**14 Satin-finish  
burnished**

LED 220-240V  
3x4.5W-120°  
WHITE 2700K  
1200lm CRI >80



INCLUDED:  
- LED / LED

LED 220-240V  
7x4.5W-120°  
WHITE 2700K  
2800lm CRI >80



Dimmerabile TRIAC. Luce diretta e indiretta / *Dimmable TRIAC. Direct and indirect light*



**QUARTER**

Pellegrini+Mengato Design

*code*

*electrification*

*technical info*

*accessories*

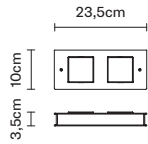

**F38 G01**

**01 White**  
**02 Black**  
**14 Satin-finish**  
*burnished*

LED 220-240V  
2x4.5W-120°  
WHITE 2700K  
800lm Cri >80

**EAC** IP40

0,007 m<sup>3</sup>  
1,00 kg

INCLUDED:  
- LED / LED

Dimmerabile TRIAC / *Dimmable TRIAC*

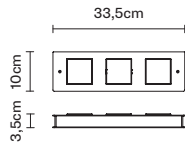

**F38 G03**

**01 White**  
**02 Black**  
**14 Satin-finish**  
*burnished*

LED 220-240V  
3x4.5W-120°  
WHITE 2700K  
1200lm Cri >80

**EAC** IP40

0,012 m<sup>3</sup>  
1,55 kg

INCLUDED:  
- LED / LED

Dimmerabile TRIAC / *Dimmable TRIAC*

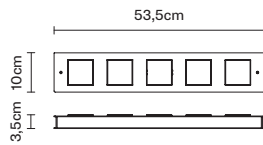

**F38 G05**

**01 White**  
**02 Black**  
**14 Satin-finish**  
*burnished*

LED 220-240V  
5x4.5W-120°  
WHITE 2700K  
2000lm Cri >80

**EAC** IP40

0,011 m<sup>3</sup>  
2,32 kg

INCLUDED:  
- LED / LED

Dimmerabile TRIAC / *Dimmable TRIAC*







**QUARTER**

Pellegrini + Mengato Design

**code**      **electrification**      **technical info**      **accessories**

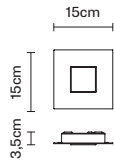

**F38 G07**  
**01 White**  
**02 Black**  
**14 Satin-finish**  
*burnished*

LED 220-240V  
 1x4.5W-120°  
 WHITE 2700K  
 400lm Cri >80

**EAC** IP40  
 0,003 m<sup>3</sup>  
 0,61 kg

INCLUDED:  
 - LED / LED

Dimmerabile TRIAC / Dimmable TRIAC

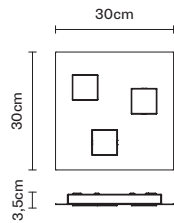

**F38 G09**  
**01 White**  
**02 Black**  
**14 Satin-finish**  
*burnished*

LED 220-240V  
 3x4.5W-120°  
 WHITE 2700K  
 1200lm Cri >80

**EAC** IP40  
 0,019 m<sup>3</sup>  
 2,18 kg

INCLUDED:  
 - LED / LED

Dimmerabile TRIAC / Dimmable TRIAC

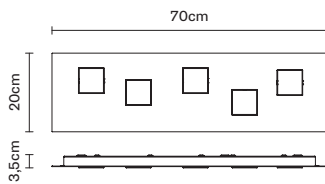

**F38 G11**  
**01 White**  
**02 Black**  
**14 Satin-finish**  
*burnished*

LED 220-240V  
 5x4.5W-120°  
 WHITE 2700K  
 2000lm Cri >80

**EAC** IP40  
 0,038 m<sup>3</sup>  
 3,32 kg

INCLUDED:  
 - LED / LED

Dimmerabile TRIAC / Dimmable TRIAC

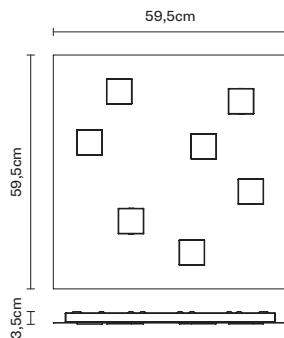

**F38 G13**  
**01 White**  
**02 Black**  
**14 Satin-finish**  
*burnished*

LED 220-240V  
 7x4.5W-120°  
 WHITE 2700K  
 2800lm Cri >80

**EAC** IP40  
 0,069 m<sup>3</sup>  
 7,97 kg

INCLUDED:  
 - LED / LED

Dimmerabile TRIAC / Dimmable TRIAC

# SLOT

—

Studio Futura

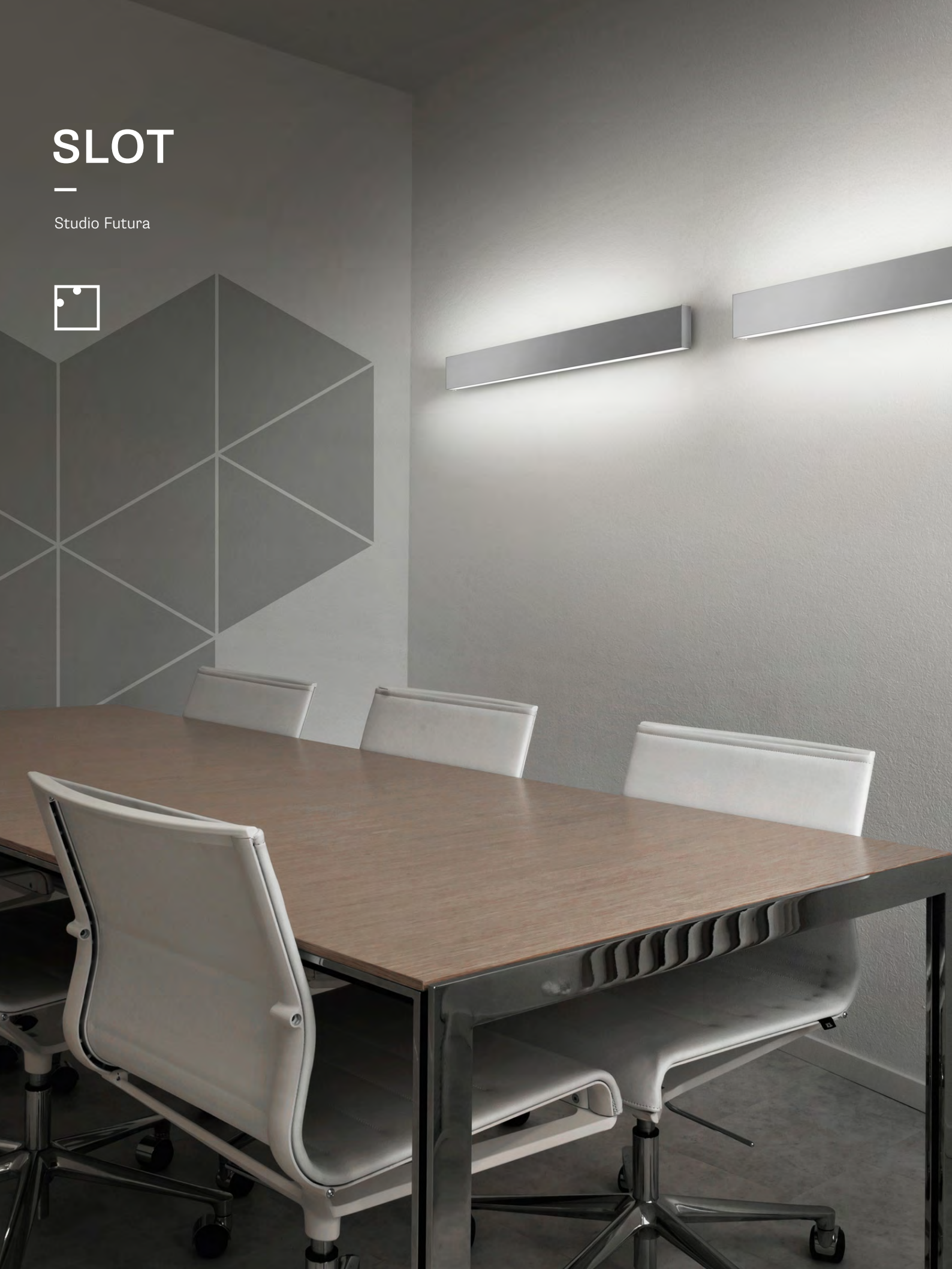

La collezione è composta da lampade da parete, soffitto e apparecchi ad incasso di diversa lunghezza, per interno. Per le lampade da parete e soffitto la struttura è in alluminio verniciato grigio o verniciato bianco a polveri, l'applique poi è chiusa nelle parti superiore e inferiore da due diffusori in polimetilmetacrilato. La versione ad incasso ha una struttura in alluminio a scomparsa totale e il diffusore in polimetilmetacrilato. L'elettrificazione è a tensione di rete per lampade alogene, fluorescenti e LED.

La colección está compuesta por apliques, plafones y aparatos de empotrar con distintas longitudes, para el interior. En los apliques y plafones, la estructura es de aluminio brillante o pintado blanco con polvos; dos difusores de polimetilmetacrilato cierran el applique por la parte superior e inferior. La versión de empotrar presenta una estructura de aluminio totalmente escamoteable y el difusor es de polimetilmetacrilato. La electrificación es con tensión de red para bombillas halógenas, fluorescentes y LED.

Die Kollektion besteht aus Wand-, Deckenlampen und Einbaulampen in verschiedenen Längen für Innenbereiche. Für die Wand- und Deckenlampen besteht die Struktur aus glänzendem Aluminium oder weiß lackiert mit Pulverbeschichtung, im oberen und unteren Teil abgeschlossen mit zwei Diffusoren aus Polymethylmethacrylat. Die Einbauausführung weist eine komplett verborgene Alustruktur und einen Diffusor aus Polymethylmetacrylat auf. Die Elektrifizierung erfolgt über Netzspannung bei Halogen-, Fluoreszenz- und LED-Lampen.

The collection is made up of wall and ceiling lamps as well as recessed lighting fixtures in different lengths, all for indoor use. The structure of the wall and ceiling lamps is in aluminium painted grey and powder coated in white. In the case of the wall lamps, the mechanism is enclosed between an upper and a lower diffuser in polymethyl-methacrylate. The recessed model has an aluminium structure, which is hidden entirely from sight, and a diffuser in polymethyl-methacrylate. The lamp runs on mains power and is suitable for use with halogen, fluorescent and LED bulbs.

La collection se compose d'appliques murales, de plafonniers et de systèmes encastrables de différentes longueurs, pour intérieur. Pour les appliques et les plafonniers, la structure est en aluminium poli ou avec revêtement blanc par poudre. L'applique est refermée sur sa partie inférieure et supérieure par deux diffuseurs en polyméthacrylate de méthyle. La version à encastrer possède une structure totalement escamotable en aluminium et le diffuseur est en polyméthacrylate de méthyle. Les lampes halogènes, fluorescentes et LED sont alimentées par la tension du réseau.

Коллекция состоит из настенных, потолочных и встраиваемых светильников различных длин, для внутренних помещений. Структура настенных и потолочных светильников из полированного алюминия или алюминия с порошковой окраской белого цвета. Настенный светильник закрыт с верхней и нижней части двумя рассеивателями из полиметилметакрилата. Алюминиевая структура встраиваемого светильника полностью скрывается после монтажа, рассеиватель из полиметилметакрилата. Электрическая часть рассчитана на галогеновые, люминесцентные и светодиодные лампы от сетевого напряжения.



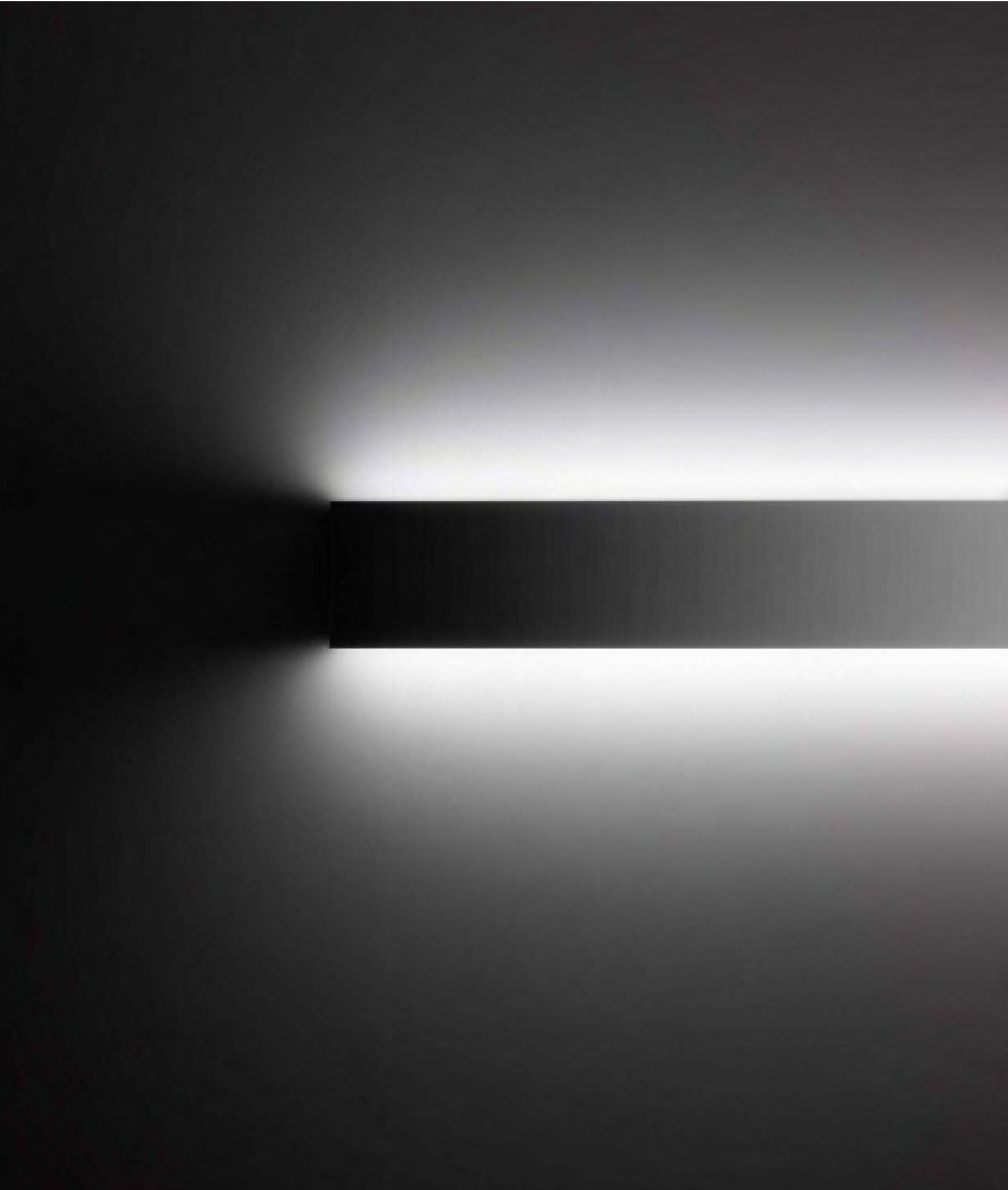

**SLOT**

Studio Futura

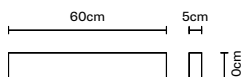

**code**

**electrification**

**technical info**

**accessories**

**F15 D02**  
01 White

LED 220-240V  
1x30W-120°  
WHITE 3000K  
2500lm Cri >80

**ERACIP40**  
0,011 m<sup>3</sup>  
2,23 kg

INCLUDED:  
- LED / LED  
- Alimentatore elettronico / Electronic driver



**F15 D02**  
61 Polished aluminium

LED 220-240V  
1x30W-120°  
WHITE 3000K  
2500lm Cri >80

**ERACIP40**  
0,011 m<sup>3</sup>  
2,23 kg

INCLUDED:  
- LED / LED  
- Alimentatore elettronico / Electronic driver

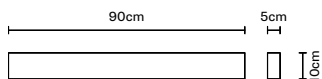

**F15 D04**  
01 White

LED 220-240V  
1x50W-120°  
WHITE 3000K  
4000lm Cri >80

**ERACIP40**  
0,017 m<sup>3</sup>  
2,95 kg

INCLUDED:  
- LED / LED  
- Alimentatore elettronico / Electronic driver



**F15 D04**  
61 Polished aluminium

LED 220-240V  
1x50W-120°  
WHITE 3000K  
4000lm Cri >80

**ERACIP40**  
0,017 m<sup>3</sup>  
2,95 kg

INCLUDED:  
- LED / LED  
- Alimentatore elettronico / Electronic driver

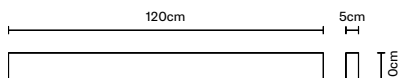

**F15 D06**  
01 White

LED 220-240V  
1x60W-120°  
WHITE 3000K  
5000lm Cri >80

**ERACIP40**  
0,022 m<sup>3</sup>  
4,05 kg

INCLUDED:  
- LED / LED  
- Alimentatore elettronico / Electronic driver



**F15 D06**  
61 Polished aluminium

LED 220-240V  
1x60W-120°  
WHITE 3000K  
5000lm Cri >80

**ERACIP40**  
0,022 m<sup>3</sup>  
4,05 kg

INCLUDED:  
- LED / LED  
- Alimentatore elettronico / Electronic driver





**SLOT**

Studio Futura



9cm



9cm



15cm

<i>code</i>	<i>electrification</i>	<i>technical info</i>	<i>accessories</i>
-------------	------------------------	-----------------------	--------------------

**F15 E01**  
01 White

GU10 220-240V  
1x75W HAGS/UB



**EAC** IP20  
0,005 m<sup>3</sup>  
0,94 kg

NOT INCLUDED:  
- Lampadina / Bulb

**F15 E01**  
61 Polished  
aluminium

GU10 220-240V  
1x75W HAGS/UB



**EAC** IP20  
0,005 m<sup>3</sup>  
0,94 kg

NOT INCLUDED:  
- Lampadina / Bulb

**F15 E02**  
01 White

LED 220-240V  
1x13W-120°  
WHITE 3000K  
1210lm Cri >80



**EAC** IP20  
0,005 m<sup>3</sup>  
0,94 kg

INCLUDED:  
- LED / LED

Dimmerabile TRIAC / Dimmable TRIAC

**F15 E02**  
61 Polished  
aluminium

LED 220-240V  
1x13W-120°  
WHITE 3000K  
1210lm Cri >80



**EAC** IP20  
0,005 m<sup>3</sup>  
0,94 kg

INCLUDED:  
- LED / LED

Dimmerabile TRIAC / Dimmable TRIAC



9cm



9cm



30cm

**F15 E03**  
01 White

GU10 220-240V  
1x75W HAGS/UB



**EAC** IP20  
0,012 m<sup>3</sup>  
1,65 kg

NOT INCLUDED:  
- Lampadina / Bulb

**F15 E03**  
61 Polished  
aluminium

GU10 220-240V  
1x75W HAGS/UB



**EAC** IP20  
0,012 m<sup>3</sup>  
1,65 kg

NOT INCLUDED:  
- Lampadina / Bulb

**F15 E04**  
01 White

LED 220-240V  
1x13W-120°  
WHITE 3000K  
1210lm Cri >80



**EAC** IP20  
0,012 m<sup>3</sup>  
1,65 kg

INCLUDED:  
- LED / LED

Dimmerabile TRIAC / Dimmable TRIAC

**F15 E04**  
61 Polished  
aluminium

LED 220-240V  
1x13W-120°  
WHITE 3000K  
1210lm Cri >80



**EAC** IP20  
0,012 m<sup>3</sup>  
1,65 kg

INCLUDED:  
- LED / LED

Dimmerabile TRIAC / Dimmable TRIAC

# TOOLS



FE Design





## CONCEPT

---

La necessità di valorizzare al massimo alcuni punti della casa, dell'ufficio e dell'ambiente in genere ha portato i designers dello studio FE Design alla progettazione di Tools, la famiglia di faretti ad incasso fissi e orientabili con una luce direzionale che fa risaltare al meglio gli spazi che necessitano di un tocco in più. Come il fascio luminoso delle stelle in una notte estiva, anche i faretti Tools sapranno ornare con raffinatezza ogni stanza decorando le parti dell'ambiente che necessitano di una luce decisa e definitiva.

The need to add a special touch to certain spots in the home, office and other buildings in general gave the designers of the FE Design studio the inspiration for the Tools range of recessed spotlights: they are available with a fixed or adjustable beam of light to light up those areas which need an extra touch. Like the light beam of the stars in a summery night sky, the Tools spotlights will add a touch of refinement to any room with bold, defined lighting.

Las exigencias de valorizar al máximo algunos puntos de la casa, de la oficina y del ambiente en general han llevado a los diseñadores del estudio FE Design a diseñar Tools, la familia de focos de empotrar, fijos y orientables, con una luz direccional, que saca el mejor partido a los espacios que demandan un toque adicional. Los focos Tools, al igual que el haz luminoso de las estrellas en una noche de verano, sabrán adornar con elegancia todas las habitaciones para decorar partes del ambiente, que requieren una luz marcada y definida.

Die Notwendigkeit, einige Punkte des Hauses, des Büros und anderer Umgebungen maximal aufzuwerten, hat die Designer des Studio FE Design zur Entwicklung von Tools geführt, die festen und ausrichtbaren Einbauspots mit einem ausgerichtetem Licht, das die Räume, die einen Touch mehr benötigen, bestens hervorhebt. Wie das Lichtbündel der Sterne in einer Sommernacht werden auch die Spotlights Tools jedes Zimmer mit Erlesenheit dekorieren und die Teile der Umgebung hervorheben, die ein entschiedenes und definiertes Licht benötigen.

La nécessité de mettre en valeur certains points de la maison, du bureau et de l'environnement a mené les designers du studio FE Design à créer Tools, une série de spots encastrables, fixes et orientables, produisant un éclairage directionnel qui valorise les espaces avec une touche supplémentaire. A l'instar des faisceaux lumineux projetés par les étoiles lors d'une nuit d'été, les spots Tools embellissent toutes les pièces avec raffinement, en faisant ressortir les détails qui requièrent un éclairage net et défini.

Дизайнеры студии FE Design разработали серию светильников Tools, которые максимально акцентируют внимание на важных местах домашнего или рабочего интерьера и окружающей среды. Встраиваемые прожекторы серии Tools с регулированием направления светового потока освещают и подчеркивают уголки интерьера, которые нуждаются в дополнительном внимании. Как звездное небо в летнюю ночь, светильники Tools изысканно оформляют каждую комнату, освещая пространство смелыми и ясными лучами.

# TOOLS

---

La collezione si costituisce di apparecchi ad incasso fissi e orientabili. Per tutti la cassaforma è in materiale termoplastico ad alto coefficiente di resistenza meccanica e termica. I faretti tondi (diam.9-14cm) e quadri (7,5x7,5cm) sono in metallo verniciato bianco a polveri. I faretti con diffusore orientabile, hanno la sfera (diam.9-14cm) in metallo cromato lucido, ramata o verniciata a polveri bianca o nera. L'elettrificazione è a bassissima tensione (12V) per lampade alogene, a tensione di rete per lampade alogene e LED (500mA).

La colección está compuesta por focos de empotrar fijos y orientables. En todos la caja de empotrar es de material termoplástico con un elevado coeficiente de resistencia mecánica y térmica. Los focos redondos (diám. 9-14cm) y cuadrados (7,5x7,5cm) son de metal pintado blanco con polvos. Los focos con difusor orientable presentan una esfera (diám.9-14cm) de metal cromado brillante, cobriza o pintada con polvos de color blanco o negro. La electrificación es con tensión muy baja (12V) para bombillas halógenas y con tensión de red para bombillas halógenas y LED (500mA).

Die Kollektion besteht aus festen und ausrichtbaren Einbauleuchten. Bei allen Modellen ist das Gehäuse aus thermoplastischem Material mit hohen mechanischen und Wärmefestigkeitskoeffizienten. Die runden (Durchm. 9-14 cm) und quadratischen (7,5 x 7,5 cm) Spotlights sind aus weißem pulverbeschichtetem Metall. Die Spotlights mit ausrichtbarem Diffusor weisen eine Kugel (Durchm. 9-14 cm) aus glanzverchromtem, kupferbeschichtetem oder weiß oder schwarz pulverbeschichtetem Metall auf. Die Elektrifizierung mit Niederspannung (12 V) für Halogenlampen und mit Netzspannung für Halogen- und LED-Lampen (500 mA).

The collection is made up of fixed and adjustable recessed lighting fixtures. The outer structure of all models is in thermoplastic material with a high coefficient of mechanical and thermal resistance. The spotlights are either round (diam. 9-14 cm) or square (7.5x7.5 cm) and made in metal, powder coated in white. The sphere (diam. 9-14 cm) of the spotlights with an adjustable diffuser is available in shiny chrome-plated metal, a copper finisher or powder coated in white or black. The lamps run on a very low voltage (12V) for halogen bulbs and on mains power for halogen and LED bulbs (500mA).

La collection se compose de systèmes encastrables fixes et orientables. Tous les éléments possèdent un boîtier en matériau thermoplastique avec un coefficient de résistance mécanique et thermique élevé. Les spots ronds (diam.9-14cm) et carrés (7,5x7,5cm) sont réalisés en métal avec revêtement blanc par poudre. Les spots avec diffuseur orientable ont une sphère (diam.9-14cm) en métal chromé brillant, cuivré ou avec revêtement blanc ou noir par poudre. Lampes halogènes alimentées à très basse tension (12V), lampes halogènes et LED (500mA) alimentées par la tension du réseau.

Коллекция состоит из встраиваемых светильников с прямым или регулируемым световым потоком для внутренних помещений. Корпус из термопластичного материала с высоким коэффициентом механического и термического сопротивления. Круглые (диам. 9-14 см) и квадратные (7,5 x 7,5 см) прожекторы из металла с белым порошковым покрытием. Сфера (диам. 9-14 см) прожекторов с регулируемым рассеивателем из металла с блестящим хромированным, медным или с белым или черным порошковым покрытием. Электрическая часть рассчитана на галогеновые лампы при очень низком напряжении (12V), на галогеновые и светодиодные лампы (500mA) от сетевого напряжения.



**TOOLS**

FE Design

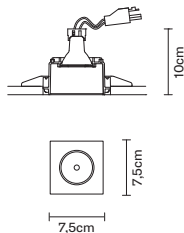

**code**

**electrification**

**technical info**

**accessories**

**F19 F01**  
01 White

GU10 220-240V  
1x50W HAGS/UB



**ERC**  **IP20**

NOT INCLUDED:  
- Lampadina / Bulb

  
0,004 m<sup>3</sup>  
0,27 kg

GU10 220-240V  
1x5,5W



**LED**

Fisso/Cassaforma+Blocco luce / Fixed/Housing+Spot light

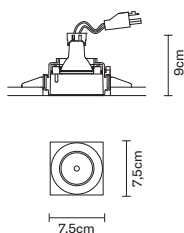

**F19 F04**  
01 White

GU10 220-240V  
1x50W HAGS/UB



**ERC**  **IP44**

NOT INCLUDED:  
- Lampadina / Bulb

  
0,008 m<sup>3</sup>  
0,45 kg

GU10 220-240V  
1x5,5W



**LED**

Fisso/Cassaforma+Blocco luce / Fixed/Housing+Spot light

**F19 L06**  
01 White

**ERC**

Blocco luce / Spot light

**F19 Z01**  
01 White

**ERC**

Cassaforma / Housing

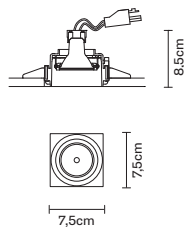

**F19 F10**  
01 White

GU10 220-240V  
1x50W HAGS/UB



**ERC**  **IP20**

NOT INCLUDED:  
- Lampadina / Bulb

  
0,004 m<sup>3</sup>  
0,27 kg

GU10 220-240V  
1x5,5W



**LED**

Orientabile/Cassaforma+Blocco luce / Adjustable/Housing+Spot light

**F19 L02**  
01 White

**ERC**

Blocco luce / Spot light

**F19 Z01**  
01 White

**ERC**

Cassaforma / Housing



**TOOLS**

FE Design

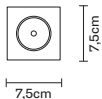
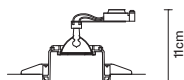

*code*

*electrification*

*technical info*

*accessories*

**F19 F02**  
01 White

GU5,3 12V  
1x50W HRGS



**ERC** III IP20



0,004 m<sup>3</sup>  
0,29 kg

NOT INCLUDED:  
- Lampadina / *Bulb*  
- Trasformatore Elettronico / *Electronic transformer*

GU5,3 12V  
1x4W



Fisso/Cassaforma+Blocco luce / *Fixed/Housing+Spot light*

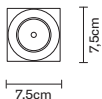
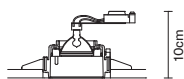

**F19 F05**  
01 White

GU5,3 12V  
1x50W HRGS



**ERC** III IP44



0,008 m<sup>3</sup>  
0,47 kg

NOT INCLUDED:  
- Lampadina / *Bulb*  
- Trasformatore Elettronico / *Electronic transformer*

GU5,3 12V  
1x4W



Fisso/Cassaforma+Blocco luce / *Fixed/Housing+Spot light*

**F19 L07**  
01 White

**ERC**

Blocco luce / *Spot light*

**F19 Z01**  
01 White

**ERC**

Cassaforma / *Housing*

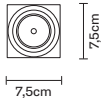
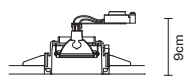

**F19 F11**  
01 White

GU5,3 12V  
1x50W HRGS



**ERC** III IP20



0,008 m<sup>3</sup>  
0,42 kg

NOT INCLUDED:  
- Lampadina / *Bulb*  
- Trasformatore Elettronico / *Electronic transformer*

GU5,3 12V  
1x4W



Orientabile/Cassaforma+Blocco luce / *Adjustable/Housing+Spot light*

**F19 L04**  
01 White

**ERC**

Blocco luce / *Spot light*

**F19 Z01**  
01 White

**ERC**

Cassaforma / *Housing*



**TOOLS**

FE Design

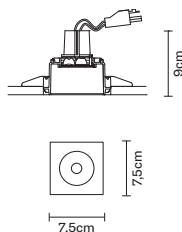

**code**

**electrification**

**technical info**

**accessories**

**F19 F03**  
01 White

LED 350mA  
1x12.5W-40°  
WHITE 3000K  
1000lm Cri >80



**EAC** III IP20  
0,004 m<sup>3</sup>  
0,33 kg

INCLUDED:  
- LED / LED

NOT INCLUDED:  
- Convertitore per LED / LED converter

Fisso/Cassaforma+Blocco luce / Fixed/Housing+Spot light

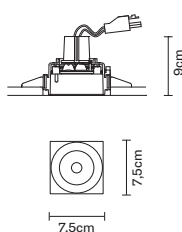

**F19 F06**  
01 White

LED 350mA  
1x12.5W-40°  
WHITE 3000K  
1000lm Cri >80



**EAC** III IP44  
0,008 m<sup>3</sup>  
0,51 kg

INCLUDED:  
- LED / LED

NOT INCLUDED:  
- Convertitore per LED / LED converter

Fisso/Cassaforma+Blocco luce / Fixed/Housing+Spot light

**F19 L08**  
01 White



Blocco luce / Spot light

**F19 Z01**  
01 White



Cassaforma / Housing

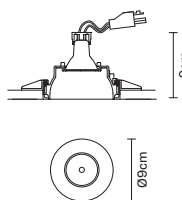

**F19 F20**  
01 White

GU10 220-240V  
1x50W HAGS/UB



**EAC** III IP20

NOT INCLUDED:  
- Lampadina / Bulb



0,004 m<sup>3</sup>  
0,25 kg

GU10 220-240V  
1x5,5W



Fisso/Cassaforma+Blocco luce / Fixed/Housing+Spot light





**TOOLS**

FE Design

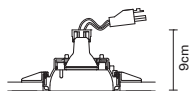

**code**

**electrification**

**technical info**

**accessories**

**F19 F23**  
01 White

GU10 220-240V  
1x50W HAGS/UB



**ERC**  IP44

NOT INCLUDED:  
- Lampadina / Bulb

 0,008 m<sup>3</sup>  
0,44 kg

GU10 220-240V  
1x5,5W



Fisso/Cassaforma+Blocco luce / Fixed/Housing+Spot light

**F19 L06**  
01 White

**ERC**

Blocco luce / Spot light

**F19 Z02**  
01 White

**ERC**

Cassaforma / Housing

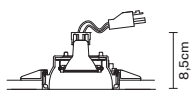

**F19 F30**  
01 White

GU10 220-240V  
1x50W HAGS/UB



**ERC**  IP20

NOT INCLUDED:  
- Lampadina / Bulb

 0,008 m<sup>3</sup>  
0,38 kg

GU10 220-240V  
1x5,5W



Orientabile/Cassaforma+Blocco luce / Adjustable/Housing+Spot light

**F19 L02**  
01 White

**ERC**

Blocco luce / Spot light

**F19 Z02**  
01 White

**ERC**

Cassaforma / Housing

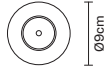
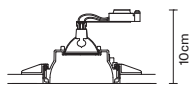

**F19 F21**  
01 White

GU5,3 12V  
1x50W HRGS



**ERC**  IP20

NOT INCLUDED:  
- Lampadina / Bulb  
- Trasformatore Elettronico / Electronic transformer

 0,004 m<sup>3</sup>  
0,27 kg

GU5,3 12V  
1x4W



Fisso/Cassaforma+Blocco luce / Fixed/Housing+Spot light

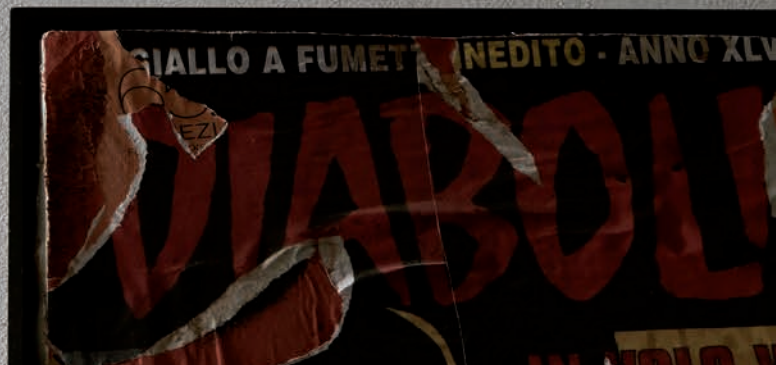

**TOOLS**

FE Design

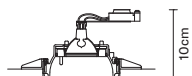

**code**

**electrification**

**technical info**

**accessories**

**F19 F24**  
01 White

GU5,3 12V  
1x50W HRGS



**ERC** III IP44



0,008 m<sup>3</sup>  
0,40 kg

NOT INCLUDED:  
- Lampadina / Bulb  
- Trasformatore Elettronico / Electronic transformer

GU5,3 12V  
1x4W



Fisso/Cassaforma+Blocco luce / Fixed/Housing+Spot light

**F19 L07**  
01 White

**ERC**

Blocco luce / Spot light

**F19 Z02**  
01 White

**ERC**

Cassaforma / Housing

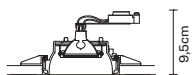

**F19 F31**  
01 White

GU5,3 12V  
1x50W HRGS



**ERC** III IP20



0,008 m<sup>3</sup>  
0,42 kg

NOT INCLUDED:  
- Lampadina / Bulb  
- Trasformatore Elettronico / Electronic transformer

GU5,3 12V  
1x4W



Orientabile/Cassaforma+Blocco luce / Adjustable/Housing+Spot light

**F19 L04**  
01 White

**ERC**

Blocco luce / Spot light

**F19 Z02**  
01 White

**ERC**

Cassaforma / Housing

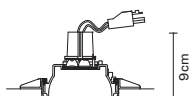

**F19 F22**  
01 White

LED 350mA  
1x12.5W-40°  
WHITE 3000K  
1000lm Cri >80



**ERC** III IP20

0,004 m<sup>3</sup>  
0,31 kg



INCLUDED:  
- LED / LED  
NOT INCLUDED:  
- Convertitore per LED / LED converter

Fisso/Cassaforma+Blocco luce / Fixed/Housing+Spot light



**TOOLS**

FE Design

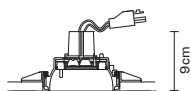

**code**

**electrification**

**technical info**

**accessories**

**F19 F25**  
01 White

LED 350mA  
1x12.5W-40°  
WHITE 3000K  
1000lm Cri >80



**ERC** III IP44  
0,008 m<sup>3</sup>  
0,50 kg



INCLUDED:  
- LED / LED  
NOT INCLUDED:  
- Convertitore per LED / LED converter

Fisso/Cassaforma+Blocco luce / Fixed/Housing+Spot light

**F19 L08**  
01 White

**ERC**

Blocco luce / Spot light

**F19 Z02**  
01 White

**ERC**

Cassaforma / Housing

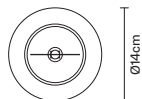
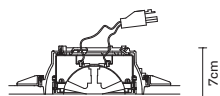

**F19 F50**  
01 White

G53 12V  
1x100W HMGS/UB



**ERC** III IP20  
360° ADJUSTABLE SYSTEM  
0,012 m<sup>3</sup>  
0,51 kg



NOT INCLUDED:  
- Lampadina / Bulb  
- Trasformatore Elettronico / Electronic transformer

Orientabile/Cassaforma+Blocco luce / Adjustable/Housing+Spot light

**F19 L11**  
01 White

**ERC**

Blocco luce / Spot light

**F19 Z04**  
01 White

**ERC**

Cassaforma / Housing



**TOOLS**

FE Design

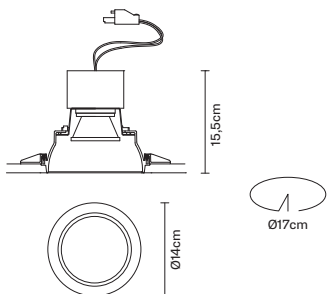

**code**

**electrification**

**technical info**

**accessories**

**F19 F53**  
01 White

LED 500mA  
1x20W-34°  
WHITE 3000K  
2000lm Cri >80

**EAC** III IP20  
0,012 m<sup>3</sup>  
0,55 kg

INCLUDED:  
- LED / LED  
NOT INCLUDED:  
- Convertitore per LED / LED converter

Fisso/Cassaforma+Blocco luce / Fixed/Housing+Spot light

**F19 L18**  
01 White

**EAC**

Blocco luce / Spot light

**F19 Z04**  
01 White

**EAC**

Cassaforma / Housing

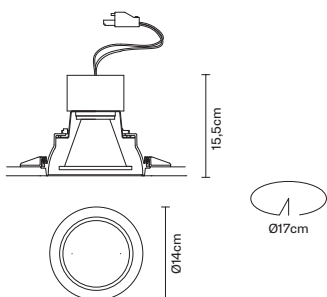

**F19 F54**  
01 White

LED 500mA  
1x20W-22°  
WHITE 3000K  
2000lm Cri >80

**EAC** III IP20  
0,012 m<sup>3</sup>  
0,55 kg

INCLUDED:  
- LED / LED  
NOT INCLUDED:  
- Convertitore per LED / LED converter

Fisso/Cassaforma+Blocco luce / Fixed/Housing+Spot light

**F19 L19**  
01 White

**EAC**

Blocco luce / Spot light

**F19 Z04**  
01 White

**EAC**

Cassaforma / Housing





**TOOLS**

FE Design

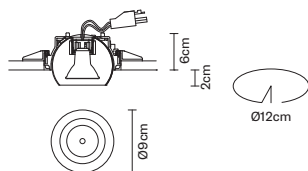

**code**

**electrification**

**technical info**

**accessories**

**F19 F40**  
01 White  
02 Black  
15 Chrome  
41 Copper

GU10 220-240V  
1x50W HAGS/UB



**EAC**  **IP20**  
360° ADJUSTABLE SYSTEM  
0,008 m<sup>3</sup>  
0,55 kg

NOT INCLUDED:  
- Lampadina / Bulb

GU10 220-240V  
1x5,5W



Orientabile/Cassaforma+Blocco luce / Adjustable/Housing+Spot light

**F19 L09**  
01 White  
02 Black



Blocco luce / Spot light

**F19 Z03**  
01 White



Cassaforma / Housing

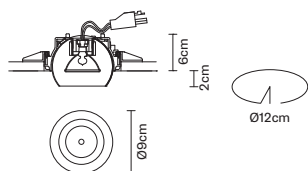

**F19 F41**  
01 White  
02 Black  
15 Chrome  
41 Copper

GU5,3 12V  
1x50W HRGS



**EAC**  **IP20**  
360° ADJUSTABLE SYSTEM  
0,008 m<sup>3</sup>  
0,54 kg

NOT INCLUDED:  
- Lampadina / Bulb  
- Trasformatore Elettronico / Electronic transformer

GU5,3 12V  
1x4W



Orientabile/Cassaforma+Blocco luce / Adjustable/Housing+Spot light

**F19 L10**  
01 White  
02 Black



Blocco luce / Spot light

**F19 Z03**  
01 White



Cassaforma / Housing



**TOOLS**

FE Design

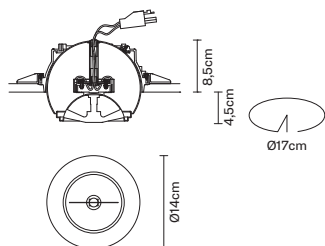

**code**

**electrification**

**technical info**

**accessories**

**F19 F60**  
01 White  
02 Black  
15 Chrome  
41 Copper

G53 12V  
1x100W HMGS/UB



**EAC** III IP20  
360° ADJUSTABLE SYSTEM  
0,012 m<sup>3</sup>  
0,80 kg

NOT INCLUDED:  
- Lampadina / Bulb  
- Trasformatore Elettronico / Electronic transformer

G53 12V  
1x15W



Orientabile/Cassaforma+Blocco luce / Adjustable/Housing+Spot light

**F19 L14**  
01 White  
02 Black



Blocco luce / Spot light

**F19 Z05**  
01 White



Cassaforma / Housing

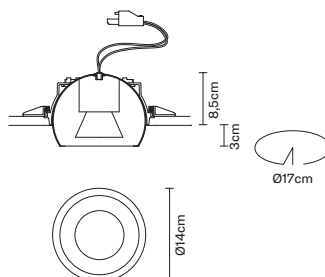

**F19 F63**  
01 White  
02 Black  
15 Chrome  
41 Copper

LED 500mA  
1x20W-34°  
WHITE 3000K  
2000lm Cri >80



**EAC** III IP20  
360° ADJUSTABLE SYSTEM  
0,012 m<sup>3</sup>  
0,85 kg

INCLUDED:  
- LED / LED

NOT INCLUDED:  
- Convertitore per LED / LED converter

Orientabile/Cassaforma+Blocco luce / Adjustable/Housing+Spot light

**F19 L17**  
01 White  
02 Black



Blocco luce / Spot light

**F19 Z05**  
01 White



Cassaforma / Housing



# MONTAGGIO / ASSEMBLY

1.

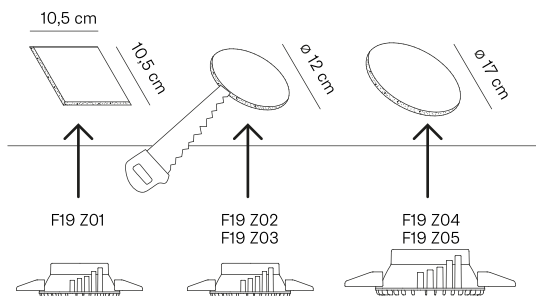

Scegliere la dimensione del foro da fare sul cartongesso in base al tipo di cassaforma.

*Determine the size of the hole to be made in the plasterboard, depending on the type of formwork.*

2.

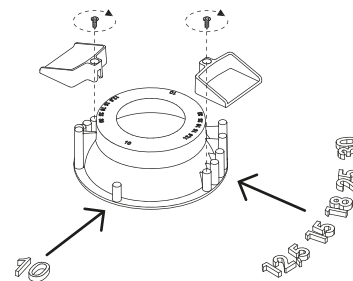

La cassaforma viene fornita già predisposta per lo spessore di 12,5 mm del cartongesso. Per spessori diversi spostare le alette.

*The formwork is supplied ready for a plasterboard thickness of 12.5 mm. For other thicknesses, move the tabs.*

3.

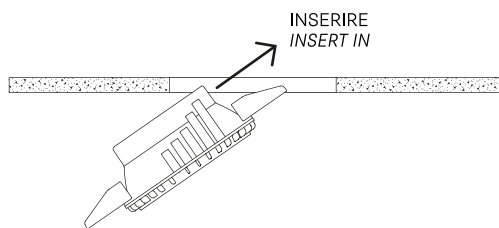

Inserire la cassaforma all'interno del cartongesso e posizionarla in corrispondenza del foro.

*Fit the formwork inside the plasterboard and position it over the hole.*

4.

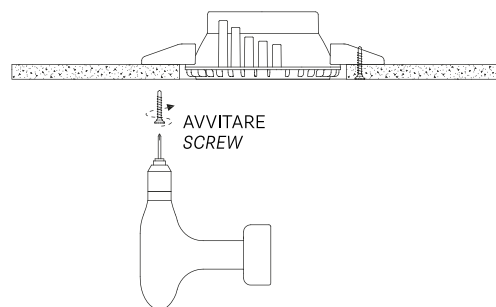

In corrispondenza delle alette, fissare la cassaforma al cartongesso utilizzando le viti incluse nella confezione.

*Where the tabs are, fasten the formwork to the plasterboard using the screws provided in the pack.*

5.

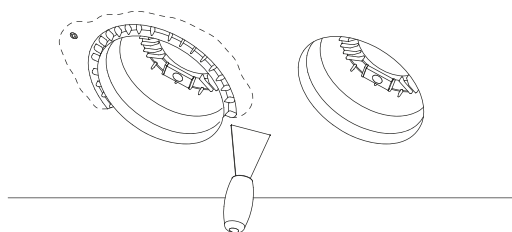

Stuccare perfettamente i bordi della cassaforma in modo da uniformare la finitura del soffitto con l'interno della cassaforma.

*Perfectly plaster the edges of the formwork so the ceiling finish is uniform with the inside of the formwork.*

6.

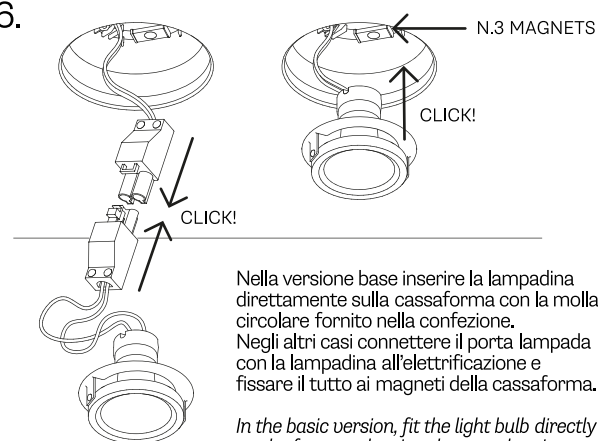

Nella versione base inserire la lampadina direttamente sulla cassaforma con la molla circolare fornito nella confezione. Negli altri casi connettere il porta lampada con la lampadina all'elettrificazione e fissare il tutto ai magneti della cassaforma.

*In the basic version, fit the light bulb directly on the formwork using the round spring provided in the pack. In other cases, connect the lamp holder with light bulb to the power supply and fasten the whole to the formwork magnets.*

# VENUS

FE Design

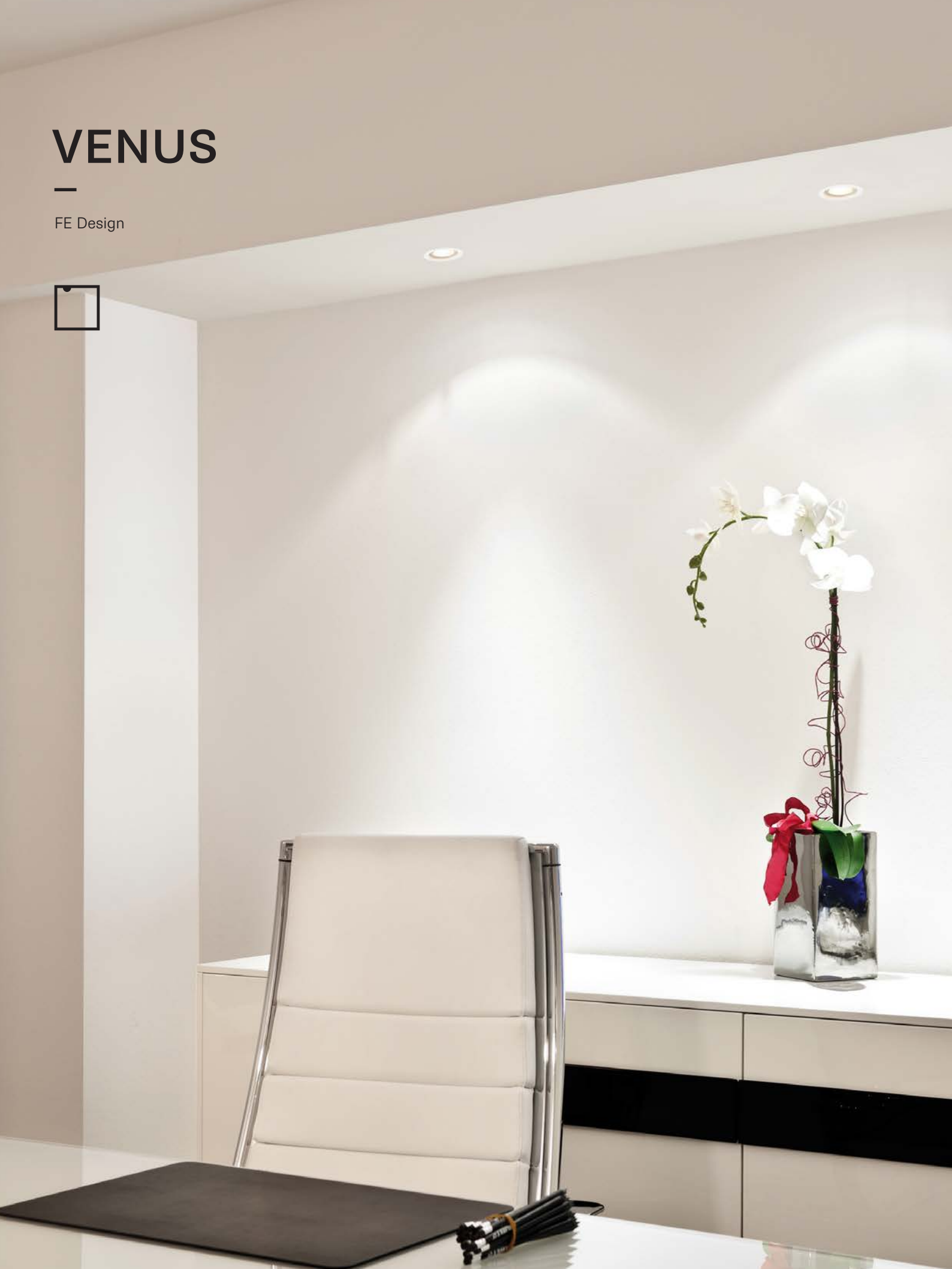

La collezione è costituita da apparecchi ad incasso. Le strutture metalliche, fisse o orientabili, sono in alluminio lucidato o verniciato bianco. La loro forma semplice e pura li rende molto versatili, adatti ad ogni tipo di ambiente pubblico o privato, grazie anche alla vasta scelta di sorgenti luminose. La caratteristica di alcuni faretti è la dimmerazione che, oltre ad abbassare la luminosità ne modula il colore rendendo la luce più calda o fredda. L'elettrificazione è a tensione di rete per LED.

The collection is made up of recessed lighting fixtures. The metallic structures can be either fixed or adjustable, and are in polished aluminium or powder-coated in white. Their simple, pure shape makes these lamps very versatile and suitable for use in any type of public space or the home, also due to the fact that they are suitable for use with many different light sources. Some spot lights are dimmerable which not only allows the brightness to be turned down but also changes their colour to create a warm or cold light. The lamps run on mains power with LED bulbs.

La colección está compuesta por focos de empotrar. Las estructuras metálicas, fijas u orientables, son de aluminio abrillantado o pintado de color blanco. Sus formas sencillas y puras los convierten en elementos muy versátiles, idóneos para todos los tipos de ambientes, públicos o privados, también por la amplia elección de fuentes luminosas. La característica de algunos focos es la regulación de la luz, que además de disminuir la luminosidad modula su color por lo que la luz resulta más cálida o fría. La electrificación es con tensión de red para Led.

Die Kollektion besteht aus Einbau-Beleuchtungen. Die festen oder ausrichtbaren Metallstrukturen bestehen aus poliertem oder weiß lackiertem Alu. Ihre einfache und reine Form gestaltet sie perfekt für jede Art von öffentlicher oder privater Umgebung, auch dank der großen Auswahl an Leuchtquellen. Die Eigenschaft einiger Spots ist die Dimmung, die nicht nur die Helligkeit senkt, sondern die Farbe moduliert und sie so wärmer oder kälter gestaltet. Die Elektrifizierung erfolgt über Netzspannung bei LED-Lampen.

La collection se compose d'appareils à encastrement. Les structures métalliques, fixes ou orientables sont en aluminium brillant ou peintes en blanc. La forme simple et nette de ces objets universels s'adapte à tout type d'établissement public ou privé, grâce également à un vaste choix de sources de lumière. Certains spots sont munis d'un variateur de lumière, capable de moduler l'intensité de lumière en offrant une couleur chaude ou froide. Cette collection est équipée d'ampoules LED.

Коллекция представляет собой встраиваемые в стену светильники. Фиксированные или вращающиеся металлические структуры выполнены из отполированного алюминия или окрашены в белый цвет. Благодаря простой и правильной форме светильников, а также их широкому выбору лампы этой коллекции универсальны и подходят для любых интерьеров, будь то частные дома или общественные помещения. Некоторые точечные светильники, помимо регулятора яркости, оснащены также регулятором цвета, благодаря которому возможно получить более теплое или холодное освещение. Цоколь предназначен для светодиода (LED).



**VENUS**  
FE Design

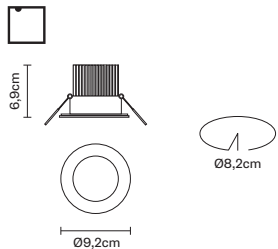

**code**

**electrification**

**technical info**

**accessories**

**F40 F01**  
01 White  
11 Polished  
aluminium

LED 220-240V  
1x13W-30°  
WHITE 3000K  
1010lm Cri >92



INCLUDED:  
- LED / LED  
- Alimentatore elettronico dimmerabile /  
Dimmable electronic driver

Faretto tondo orientabile. Dimmerabile / Adjustable round spot. Dimmable

**F40 F05**  
01 White  
11 Polished  
aluminium

LED 220-240V  
1x13W-30°  
WHITE 3000K  
1010lm Cri >92



INCLUDED:  
- LED / LED  
- Alimentatore elettronico a luce  
dinamica / Electronic driver for  
dynamic light

Faretto tondo orientabile. Dimmerabile con cambio temperatura colore da 3000K a 2000K / Adjustable round spot. Dimmable with colour tuning from 3000K to 2000K

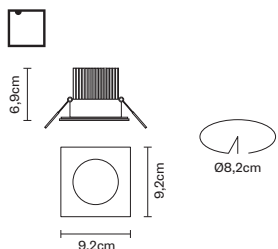

**F40 F03**  
01 White  
11 Polished  
aluminium

LED 220-240V  
1x13W-30°  
WHITE 3000K  
1010lm Cri >92



INCLUDED:  
- LED / LED  
- Alimentatore elettronico dimmerabile /  
Dimmable electronic driver

Faretto quadro orientabile. Dimmerabile / Adjustable square spot. Dimmable

**F40 F07**  
01 White  
11 Polished  
aluminium

LED 220-240V  
1x13W-30°  
WHITE 3000K  
1010lm Cri >92



INCLUDED:  
- LED / LED  
- Alimentatore elettronico a luce  
dinamica / Electronic driver for  
dynamic light

Faretto quadro orientabile. Dimmerabile con cambio temperatura colore da 3000K a 2000K / Adjustable square spot. Dimmable with colour tuning from 3000K to 2000K

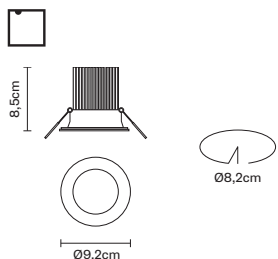

**F40 F09**  
01 White  
11 Polished  
aluminium

LED 220-240V  
1x13W-30°  
WHITE 3000K  
1010lm Cri >92



INCLUDED:  
- LED / LED  
- Alimentatore elettronico dimmerabile /  
Dimmable electronic driver

Faretto tondo fisso. Dimmerabile / Fixed round spot. Dimmable

**F40 F13**  
01 White  
11 Polished  
aluminium

LED 220-240V  
1x13W-30°  
WHITE  
3000K-2000K  
800lm Cri >92



INCLUDED:  
- LED / LED  
- Alimentatore elettronico a luce  
dinamica / Electronic driver for  
dynamic light

Faretto tondo fisso. Dimmerabile con cambio temperatura colore da 3000K a 2000K / Fixed round spot. Dimmable with colour tuning from 3000K to 2000K



**VENUS**  
FE Design

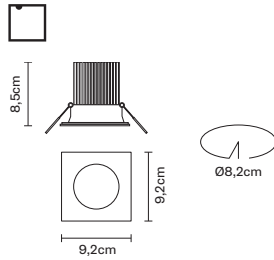

**code**

**electrification**

**technical info**

**accessories**

**F40 F11**  
01 White  
11 Polished  
aluminium

LED 220-240V  
1x13W-30°  
WHITE 3000K  
1010lm CRI >92

**EAC** IP44

INCLUDED:  
- LED / LED  
- Alimentatore elettronico dimmerabile /  
Dimmable electronic driver

Faretto quadro fisso. Dimmerabile / Fixed square spot. Dimmable

**F40 F15**  
01 White  
11 Polished  
aluminium

LED 220-240V  
1x13W-30°  
WHITE  
3000K-2000K  
800lm CRI >92

**EAC** IP44

INCLUDED:  
- LED / LED  
- Alimentatore elettronico a luce  
dinamica / Electronic driver for  
dynamic light

Faretto quadro fisso. Dimmerabile con cambio temperatura colore da 3000K a  
2000K / Fixed square spot. Dimmable with colour tuning from 3000K to 2000K

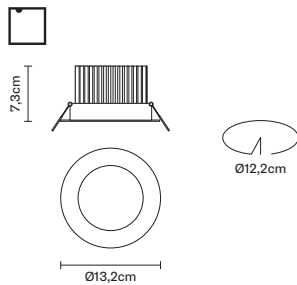

**F40 F17**  
01 White  
11 Polished  
aluminium

LED 220-240V  
1x18W-35°  
WHITE 3000K  
1700lm CRI >92

**EAC** IP20  
360°  
ADJUSTABLE  
SYSTEM

INCLUDED:  
- LED / LED  
- Alimentatore elettronico dimmerabile /  
Dimmable electronic driver

Faretto tondo orientabile. Dimmerabile / Adjustable round spot. Dimmable

**F40 F25**  
01 White  
11 Polished  
aluminium

LED 220-240V  
1x26W-35°  
WHITE 3000K  
2400lm CRI >92

**EAC** IP20  
360°  
ADJUSTABLE  
SYSTEM

INCLUDED:  
- LED / LED  
- Alimentatore elettronico dimmerabile /  
Dimmable electronic driver

Faretto tondo orientabile. Dimmerabile / Adjustable round spot. Dimmable

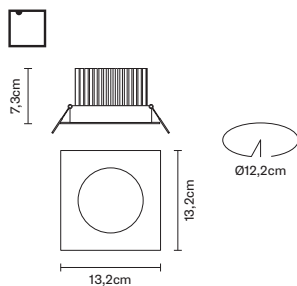

**F40 F19**  
01 White  
11 Polished  
aluminium

LED 220-240V  
1x18W-35°  
WHITE 3000K  
1700lm CRI >92

**EAC** IP20  
360°  
ADJUSTABLE  
SYSTEM

INCLUDED:  
- LED / LED  
- Alimentatore elettronico dimmerabile /  
Dimmable electronic driver

Faretto quadro orientabile. Dimmerabile / Adjustable square spot. Dimmable

**F40 F27**  
01 White  
11 Polished  
aluminium

LED 220-240V  
1x26W-35°  
WHITE 3000K  
2400lm CRI >92

**EAC** IP20  
360°  
ADJUSTABLE  
SYSTEM

INCLUDED:  
- LED / LED  
- Alimentatore elettronico dimmerabile /  
Dimmable electronic driver

Faretto quadro orientabile. Dimmerabile / Adjustable square spot. Dimmable



**VENUS**  
FE Design

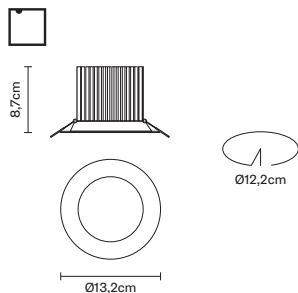

**code**

**electrification**

**technical info**

**accessories**

**F40 F21**  
01 White  
11 Polished  
aluminium

LED 220-240V  
1x18W-35°  
WHITE 3000K  
1700lm Cri >92

**EAC**  IP44

INCLUDED:  
- LED / LED  
- Alimentatore elettronico dimmerabile /  
Dimmable electronic driver

Faretto tondo fisso. Dimmerabile / Fixed round spot. Dimmable

**F40 F29**  
01 White  
11 Polished  
aluminium

LED 220-240V  
1x26W-35°  
WHITE 3000K  
2400lm Cri >92

**EAC**  IP44

INCLUDED:  
- LED / LED  
- Alimentatore elettronico dimmerabile /  
Dimmable electronic driver

Faretto tondo fisso. Dimmerabile / Fixed round spot. Dimmable

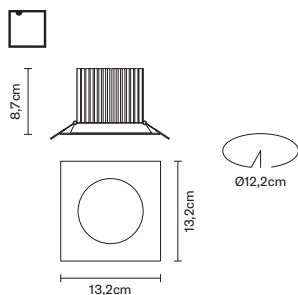

**F40 F23**  
01 White  
11 Polished  
aluminium

LED 220-240V  
1x18W-35°  
WHITE 3000K  
1700lm Cri >92

**EAC**  IP44

INCLUDED:  
- LED / LED  
- Alimentatore elettronico dimmerabile /  
Dimmable electronic driver

Faretto quadro fisso. Dimmerabile / Fixed square spot. Dimmable

**F40 F31**  
01 White  
11 Polished  
aluminium

LED 220-240V  
1x26W-35°  
WHITE 3000K  
2400lm Cri >92

**EAC**  IP44

INCLUDED:  
- LED / LED  
- Alimentatore elettronico dimmerabile /  
Dimmable electronic driver

Faretto quadro fisso. Dimmerabile / Fixed square spot. Dimmable

# ZEN

—

Pamio Design



Zen è un sistema modulare ad incasso per controsoffitti in cartongesso per interno. Si compone del modulo scatola, interamente in alluminio e disponibile in diverse misure e del blocco luce (14x14cm) che comprende la parte elettrica. Le elettrificazioni sono molteplici: a tensione di rete per lampade fluorescenti (standard, dimmerabile o di emergenza, completa di diffusore in polimetilmetacrilato) e per lampade a ioduri metallici; a bassissima tensione (12V) per lampade alogene. Se si utilizza il sistema modulare, tutte queste elettrificazioni possono essere installate in combinazione con la fluorescenza.

Zen es un sistema modular de empotrar para falso techo de pladur para interior. Está compuesto por el módulo caja, totalmente de aluminio y disponible en distintos tamaños, y por el bloque luz (14x14cm), que comprende la parte eléctrica. Las electrificaciones son múltiples: con tensión de red para bombillas fluorescentes (estándar, luz regulable o con emergencia, con difusor de polimetilmetacrilato) y para bombillas de ioduros metálicos; de tensión muy baja (12V) para bombillas halógenas. Si se usa el sistema modular, todas estas electrificaciones pueden instalarse en combinación con la fluorescencia.

Zen ist ein Einbau-Modulsystem für Zwischendecken in Innenbereichen. Es besteht aus dem Modulkasten aus Aluminium, der in verschiedenen Maßen verfügbar ist und aus der Beleuchtungseinrichtung (14x14 cm), die die Elektrifizierung enthält. Vielfältig die Elektrifizierungen: Netzspannung für Fluoreszenzlampen (Standard, mit Dimmer oder Notlicht) mit Diffusor aus Polymethylmethacrylat und für Metalljodurlampen; für Halogenlampe mit Niederspannung (12V). Wenn das modulare System verwendet wird, können all diese Elektrifizierungen in Verbindung mit Fluoreszenz montiert werden.

Zen is a recessed modular lighting system for indoor use and installed in false ceilings in plasterboard. It consists of an aluminium modular box, available in several sizes, and a lighting block (14x14cm), which holds all the electrical parts. The lamp can be powered in many different ways: on mains voltage for fluorescent bulbs (standard, dimmerable or emergency lights, complete with a polymethyl-methacrylate diffuser) and for metal halide bulbs; or on a very low voltage (12V) for halogen bulbs. If these lamps are grouped together in a modular layout, they can be installed and used with a fluorescent lighting system.

Zen est un système modulaire à encastrer pour faux plafonds en placoplâtre et pour intérieur. Il se compose d'une boîte, entièrement en aluminium et disponible en différentes dimensions et d'un corps d'éclairage qui comprend la partie électrique. Plusieurs alimentations disponibles: par tension du réseau pour les lampes fluorescentes (standard, dimmable ou d'urgence avec diffuseur en polyméthylméthacrylate) et pour les lampes à iodures métalliques ; à très basse tension (12V) pour les lampes halogènes. Si on utilise le système modulaire, toutes ces alimentations peuvent être installées en association avec la fluorescence.



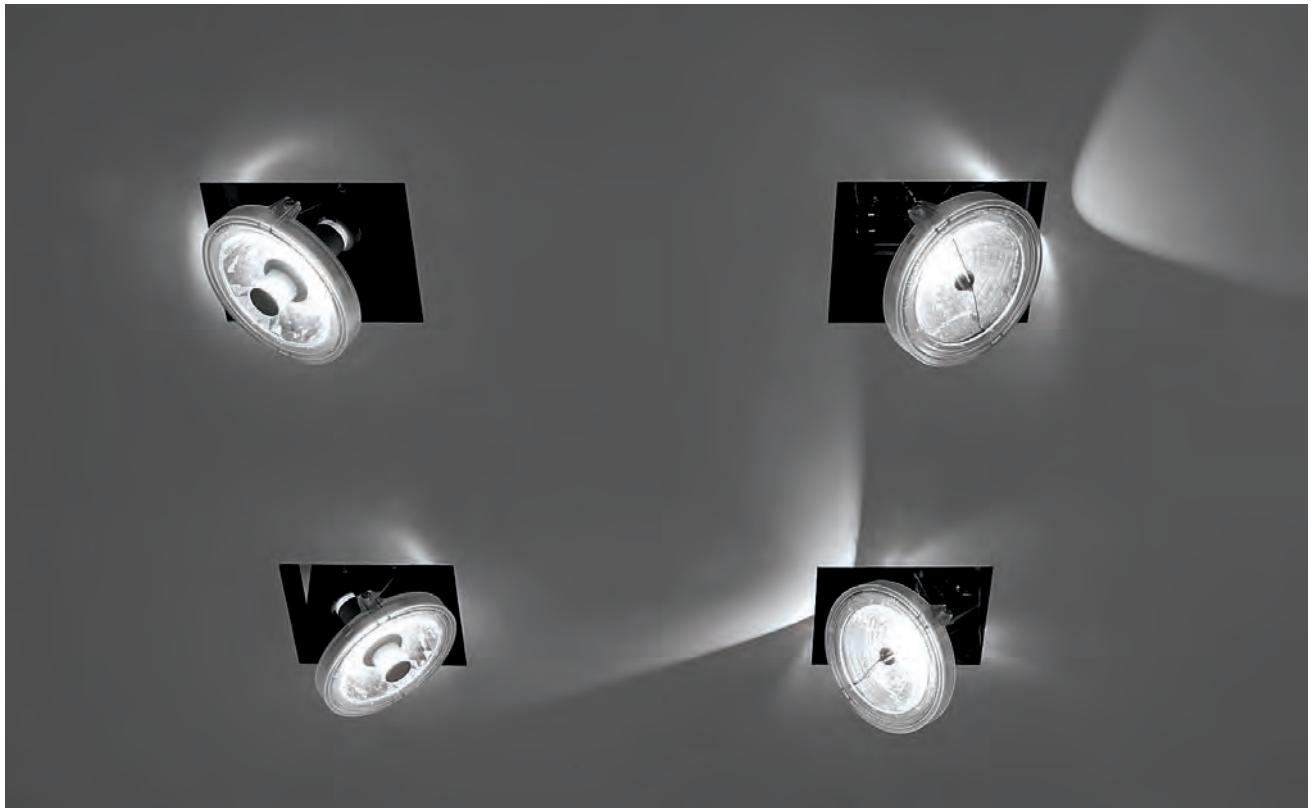

Zen – это модульная встраиваемая система для навесных потолков из гипсокартона. Состоит из корпуса, полностью изготовленного из алюминия и в наличии различных размеров, и светового блока (14x14 см) с электрической частью. Многочисленные варианты электрической части рассчитаны на люминесцентные лампы (обычные, диммируемые или для дежурного освещения), укомплектованные рассеивателем из полиметилметакрилата, и для металлогалогенных ламп; на галогеновые лампы при очень низком напряжении (12V). При установке модульной системы все электрические части могут быть установлены в комбинации с люминесцентными лампами.



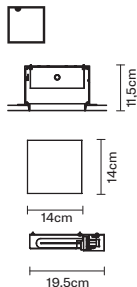

**ZEN**  
Pamio Design



<i>code</i>	<i>electrification</i>	<i>technical info</i>	<i>accessories</i>
<b>D67 L01</b>	G24q-3 220-240V 2x26W FSD 	<b>EAC</b> IP20 0 m <sup>3</sup> 0,76 kg	INCLUDED: - Alimentatore / Driver  NOT INCLUDED: - Lampadina / Bulb - Cassaforma / Housing
<b>D67 L11</b>	G24q-3 220-240V 2x26W FSD 	<b>EAC</b> IP20 0 m <sup>3</sup> 0,85 kg	INCLUDED: - Alimentatore dimmerabile DALI / Dimmable DALI electronic ballast  NOT INCLUDED: - Lampadina / Bulb - Cassaforma / Housing
<b>D67 L21</b>	G24q-3 220-240V 2x18W FSD 	<b>EAC</b> IP20 0,005 m <sup>3</sup> 1,38 kg	INCLUDED: - Alimentatore / Electronic ballast - Sistema per luce d'emergenza / Emergency light system  NOT INCLUDED: - Lampadina / Bulb - Cassaforma / Housing
<b>D67 L45</b>	E27 220-240V 2x18W FBT 	<b>EAC</b> IP20 0,01 m <sup>3</sup> 0,60 kg	NOT INCLUDED: - Lampadina / Bulb - Cassaforma / Housing



<b>D67 L25</b>	G53 220-240V 1x100W HMGS/UB 	<b>EAC</b>  IP20 0,003 m <sup>3</sup> 0,63 kg	INCLUDED: - Trasformatore / Transformer  NOT INCLUDED: - Lampadina / Bulb - Cassaforma / Housing
----------------	-----------------------------------------------------------------------------------------------------------------------	-----------------------------------------------------------------------------------------------------------------------------------------	-----------------------------------------------------------------------------------------------------------------

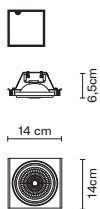

<b>D67 L26</b>	G53 220-240V 1x100W HMGS/UB 	<b>EAC</b>  IP20 0,005 m <sup>3</sup> 0,57 kg	INCLUDED: - Trasformatore / Transformer  NOT INCLUDED: - Lampadina / Bulb - Cassaforma / Housing
----------------	-----------------------------------------------------------------------------------------------------------------------	-----------------------------------------------------------------------------------------------------------------------------------------	-----------------------------------------------------------------------------------------------------------------

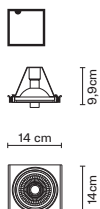

<b>D67 L34</b>	GX8,5 220-240V 1x35W MR 	<b>EAC</b> IP20  0,01 m <sup>3</sup> 0,87 kg	INCLUDED: - Trasformatore / Transformer  NOT INCLUDED: - Lampadina / Bulb - Cassaforma / Housing
----------------	-------------------------------------------------------------------------------------------------------------------	-----------------------------------------------------------------------------------------------------------------------------------------	-----------------------------------------------------------------------------------------------------------------

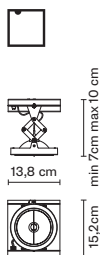

<b>D67 L37</b> <b>02 Black</b>	G53 12V 1x100W HMGS/UB 	<b>EAC</b>  IP20 0,01 m <sup>3</sup> 0,61 kg	NOT INCLUDED: - Lampadina / Bulb - Cassaforma / Housing - Trasformatore / Electronic transformer
-----------------------------------	------------------------------------------------------------------------------------------------------------------	----------------------------------------------------------------------------------------------------------------------------------------	-----------------------------------------------------------------------------------------------------------





**ZEN**

Pamio Design

**code**

**electrification**

**technical info**

**accessories**

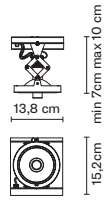

**D67 L38**  
**02 Black**

GX8,5 220-240V  
1x70W MR  

**EAC**  **IP20**  
360°  
ADJUSTABLE SYSTEM  
0,005 m<sup>3</sup>  
0,61 kg

NOT INCLUDED:  
- Lampadina / *Bulb*  
- Cassaforma / *Housing*  
- Alimentatore / *Electronic driver*

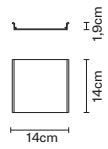

**D67 L35**

**EAC**  
0,003 m<sup>3</sup>  
0,20 kg

Alluminio / *Aluminium*

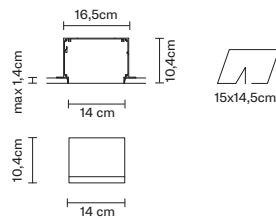

**D67 M01**

**EAC**  
0,007 m<sup>3</sup>  
0,61 kg

Cassaforma in alluminio / *Aluminium wallbox*

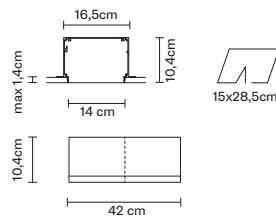

**D67 M02**

**EAC**  
0,014 m<sup>3</sup>  
1,22 kg

Cassaforma in alluminio / *Aluminium wallbox*

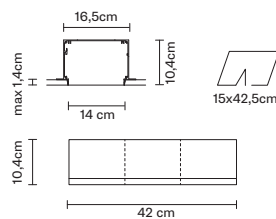

**D67 M03**

**EAC**  
0,021 m<sup>3</sup>  
1,83 kg

Cassaforma in alluminio / *Aluminium wallbox*

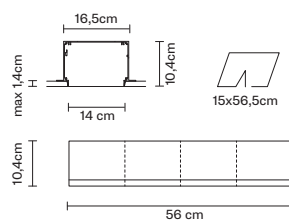

**D67 M04**

**EAC**  
0,028 m<sup>3</sup>  
3,05 kg

Cassaforma in alluminio / *Aluminium wallbox*



**ZEN**

Pamio Design

**code**

**electrification**

**technical info**

**accessories**

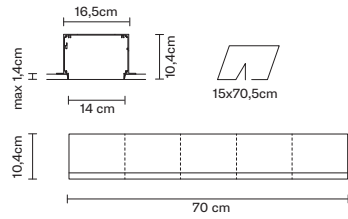

**D67 M05**

**ERC**  
0,035 m<sup>3</sup>  
4,27 kg

Cassaforma in alluminio / *Aluminium wallbox*

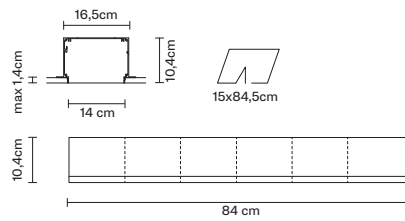

**D67 M06**

**ERC**  
0,042 m<sup>3</sup>  
5,49 kg

Cassaforma in alluminio / *Aluminium wallbox*

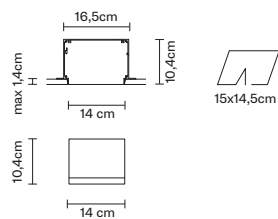

**D67 M31**  
02 Black

**ERC**  
0,007 m<sup>3</sup>  
0,61 kg

Cassaforma nera / *Black wallbox*

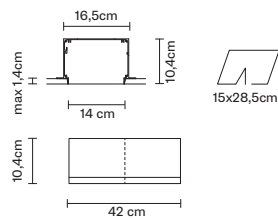

**D67 M32**  
02 Black

**ERC**  
0,014 m<sup>3</sup>  
1,22 kg

Cassaforma nera / *Black wallbox*

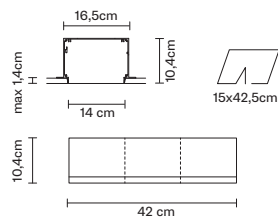

**D67 M33**  
02 Black

**ERC**  
0,021 m<sup>3</sup>  
1,83 kg

Cassaforma nera / *Black wallbox*

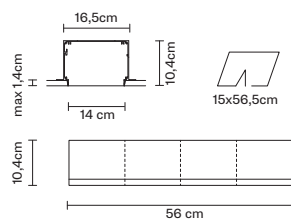

**D67 M34**  
02 Black

**ERC**  
0,028 m<sup>3</sup>  
3,05 kg

Cassaforma nera / *Black wallbox*



## ESEMPI DI APPLICAZIONI / APPLICATION EXAMPLES

14x14 cm



28x14 cm

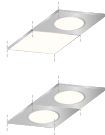

42x14 cm

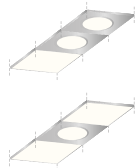

56x14 cm

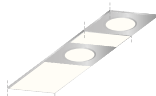

70x14 cm

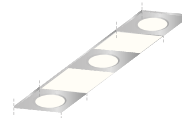

84x14 cm

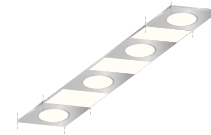

## MONTAGGIO / ASSEMBLY

Spessore cartongesso 12,5 mm - False ceiling thickness 12,5 mm

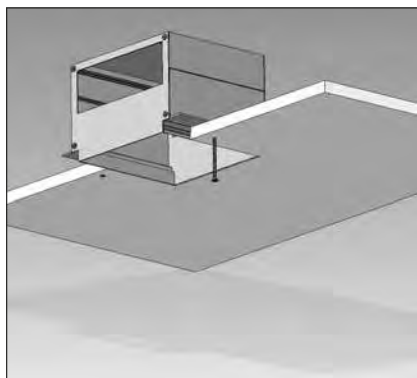

### Montaggio modulo incasso per controsoffitto

1. taglio o posizionamento del cartongesso
2. inserimento del Modulo (appoggio su due alette laterali)
3. fissaggio del Modulo al cartongesso con apposite viti
4. stuccatura dei bordi del Modulo

### Recessed module installation on false ceiling

1. cutting or positioning the false ceiling
2. fitting of the Module (using the lateral wings)
3. fixing the Module to the false ceiling using the provided screws
4. surfacing the gap between the false ceiling and the Module

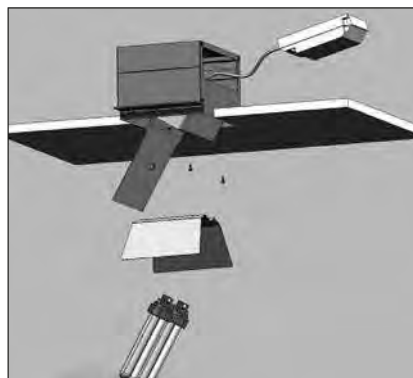

### Montaggio del blocco luce

1. collegamento dei cavi di alimentazione
2. inserimento del Blocco Luce
3. fissaggio del Blocco Luce al Modulo con apposite viti

### Lighting device installation

1. connecting the electric wires
2. fitting the Lighting Device
3. fixing the Lighting Device inside the Module using provided screws

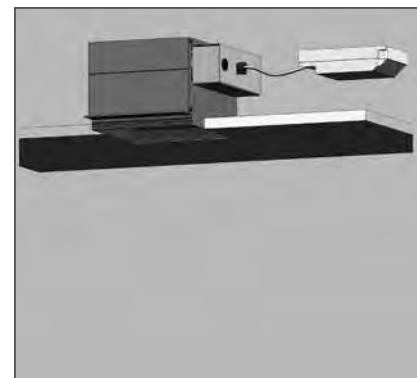

### Montaggio del diffusore

1. posizionamento del diffusore all'interno del Modulo fino a portarlo a filo soffitto (solo per fluorescenza)

### Diffuser installation

1. fitting the diffuser inside the Module to reach the ceiling level or edge limit surface mounted case (energy saver bulbs only)



# SYSTEMS

—

# FREELINE



Flynn Talbot









# CONCEPT

---

L'idea da cui nasce Freeline è l'esigenza di reinventare la luce. Tradizionalmente, l'illuminazione, e di conseguenza anche l'arredamento, di una stanza è sempre stata determinata, e limitata, dalla posizione del punto luce. Freeline permette di superare questo ostacolo, consentendo di partire dalla progettazione estetica innanzitutto, e quindi di lasciare l'illuminazione come ultima scelta. Questo sistema componibile infatti, permette di creare forme innovative, svincolate dalla posizione del punto luce. In questo contesto, l'illuminazione diventa un elemento fortemente decorativo, ma anche funzionale: la luce viene collocata dove si ritiene sia più consona, e nel corso del tempo può anche essere variata.

The idea behind Freeline is the need to reinvent light. Traditionally, the lighting - and thus furnishing - of a room has always been determined, and limited, by the position of the lighting point. Freeline overcomes this obstacle, allowing to start from the aesthetic design, and then choosing the lighting last. This modular system allows to create innovative shapes, independent from the lighting point position. In this context, the lighting becomes a strong decorative, yet functional element: the light is placed in the most fitting position, and it can also be moved at a later time.

Freeline nace de la idea de la exigencia de reinventar la luz. Tradicionalmente, la iluminación y, por consiguiente, también la decoración de una habitación estaban siempre determinadas y limitadas por la posición del punto de luz. Freeline supera este reto y permite partir ante todo del diseño estético, para dejar, por consiguiente, la iluminación como última elección. De hecho, este sistema componible permite crear formas innovadoras, desvinculadas de la posición del punto de luz. En este marco, la iluminación se convierte en un elemento marcadamente decorativo pero también funcional: la luz se coloca donde resulta más consona y, al mismo tiempo, se puede variar también.

Die Grundidee von Freeline ist das Bedürfnis, das Licht neu zu erfinden. Traditionsgemäß waren die Beleuchtung und folglich auch die Einrichtung eines Raums immer von der Position des Lichtpunkts bestimmt und eingeschränkt. Freeline ermöglicht die Überwindung dieses Hindernisses und erlaubt vor allem, die ästhetische Gestaltung an den Anfang zu stellen und zuletzt über die Beleuchtung zu entscheiden. Dieses Baukastensystem gestattet Ihnen nämlich, unabhängig von der Position des Lichtpunkts innovative Formen zu schaffen. In diesem Kontext mausert sich die Beleuchtung zu einem äußerst dekorativen Element, das aber gleichzeitig seinen Zweck erfüllt. Das Licht wird dort installiert, wo es am sinnvollsten ist, und kann im Laufe der Zeit auch verlagert werden.

Freeline a été créée pour réinventer la lumière. Traditionnellement, l'éclairage et l'ameublement d'une pièce ont toujours été déterminés et limités par la position du point d'éclairage. Freeline permet de franchir cet obstacle, en permettant de partir, tout d'abord, de la conception esthétique et de laisser l'éclairage en dernier lieu. En effet, ce système modulable permet de créer des formes innovantes, indépendamment de la position du point d'éclairage. Dans ce contexte, l'éclairage devient un élément décoratif, mais aussi fonctionnel: la lumière est dirigée là où elle est désirée et peut être changée lorsque cela s'avère nécessaire.

Идея создания линии Freeline - это необходимость изобрести новый подход к освещению. Традиционно, освещение, и следовательно, обстановка мебели в помещении определяется положением светового источника. Freeline позволяет преодолеть это препятствие, подойти к обустройству помещения с эстетической точки зрения и установить освещение в заключительный момент. Эта модульная система позволяет создавать креативные формы, не учитывая положение светового источника. В этом контексте освещение превращается в исключительно декоративный элемент, не теряя своей функциональности: световой источник устанавливается там, где он уместен, его позиция может меняться в течение времени.

# FREELINE

Freeline è un sistema modulare composto da barre in alluminio anodizzato nero di diverse lunghezze, fissate tra loro, a proprio piacimento, attraverso delle ganasce. I punti luce sono di tre forme diverse: una sfera in vetro soffiato bianco satinato, uno spot in alluminio nero con lente, un riflettore in alluminio nero con diffusore in metacrilato. Ciascun punto luce è a LED e viene fornito con lunghezze di cavo diverse. I cavi vengono nascosti all'interno delle barre. L'alimentazione può essere fatta attraverso un driver remoto oppure grazie ad un driver collocabile a soffitto o direttamente sul binario.

Freeline es un sistema modular, compuesto por barras de aluminio anodizado negro de distintas longitudes, fijadas entre sí, según el propio gusto, mediante mordazas. Los puntos de luz son de tres formas distintas: una esfera de vidrio soplado blanco satinado, un foco de aluminio negro con lente y un reflector de aluminio negro con difusor de metacrilato. Cada punto de luz es con LED y se suministra con longitudes distintas de cable. Los cables se ocultan en el interior de las barras. La alimentación se realiza mediante un driver remoto o con un driver, situado en el techo o directamente en la guía.

Freeline ist ein modulares System aus Stangen in schwarz eloxiertem Aluminium mit verschiedenen Längen, die mithilfe von Backen ganz nach Belieben verbunden werden. Die Lichtpunkte haben drei verschiedene Formen: eine Kugel aus weißem, geblasenem und satiniertem Glas, ein Strahler aus schwarzem Aluminium mit Linse, ein Reflektor aus schwarzem Aluminium mit Diffusor in Methacrylat. Jede Leuchte mit LED-Technik wird mit unterschiedlich langen Kabeln geliefert. Die Kabel sind im Innenbereich der Stangen verborgen. Die Stromversorgung erfolgt über einen Treiber mit Fernbedienung oder über ein Betriebsgerät, das an der Decke oder direkt auf der Schiene befestigt wird.

Freeline is a modular system comprising black anodized aluminium bars in different lengths, fastened to one another through clamps. The lighting points have three different shapes: a white glazed blown-glass globe, a black aluminium spot light with a lens, and a black aluminium spotlight with methacrylate diffuser. Each lighting point features a LED source and is supplied with different cable lengths. The cables are hidden within the bars. The power supply can be connected through a remote driver or through a ceiling or track-mounted driver.

Freeline est un système modulaire composé par des barres en aluminium anodisé noir de différentes longueurs, fixées entre elles, selon votre choix, au moyen des mâchoires de raccordement. Les points d'éclairage ont trois formes différentes: une sphère en verre soufflé blanc satiné, un spot en aluminium noir avec lentille, un réflecteur en aluminium noir avec diffuseur en méthacrylate. Chaque point d'éclairage est à LED et est fourni avec des câbles de différentes longueurs. Les câbles sont cachés à l'intérieur des barres. L'alimentation peut être effectuée au moyen d'un driver à distance ou bien grâce à un driver que l'on peut placer à un plafond ou sur le rail.

Freeline – это модульная система, которая состоит из стержней различной длины из черного анодированного алюминия, которые соединяются между собой в разных точках с помощью прищепок. Источники света трех различных форм: сфера из белого матового выдувного стекла, точечный источник света из черного алюминия с объективом, прожектор из черного алюминия с метакрилатовым рассеивателем. Каждый световой источник со светодиодом имеет кабеля различной длины, которые могут быть расположены внутри стержней. Источник питания энергией может быть подключен через отдаленный драйвер, через встроенный в потолок драйвер, или же напрямую на рельсах.

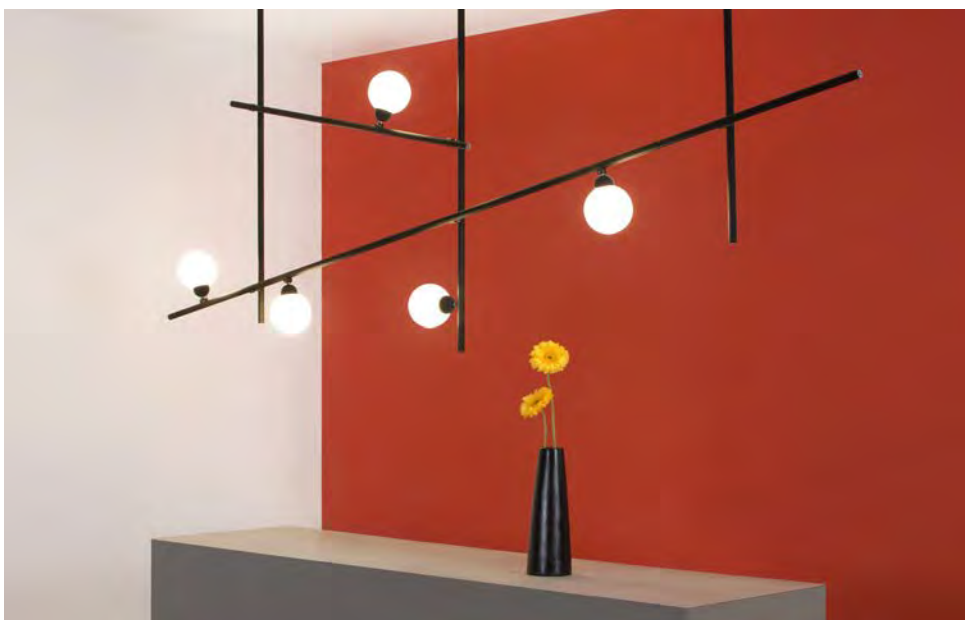



# MY FREELINE

Componi e personalizza la tua lampada Freeline  
/ *Compose and customize your Freeline lamp*

## 1. Scelta delle luci / *Spot options*

LED 24Vdc 8W WHITE 3000K 600lm Cri 80

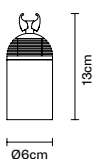

**F44L0102** 400cm cavo / cable  
**F44L0202** 1000cm cavo / cable

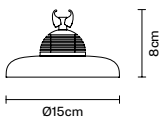

**F41L1102** 400cm cavo / cable  
**F41L1202** 1000cm cavo / cable

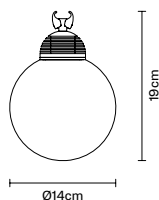

**F44L2102** 400cm cavo / cable  
**F44L2202** 1000cm cavo / cable



## 3. Scelta delle barre / *Bar options*

**F44M1102** Barra 1m / 1m bar \*  
**F44M1202** Barra 2m / 2m bar \*  
**F44M1302** Barra 3m / 3m bar \*

ERIC IP40

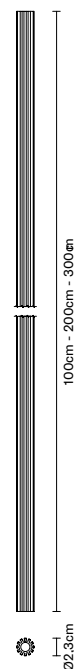

## 2. Scelta dei rosoni / *Canopies options*

Alimentatore elettronico dimmerabile 60W incluso  
/ *60W dimmable electronic driver included*

**F44M0102** 32,5x6,5x4,6cm

ERIC IP40

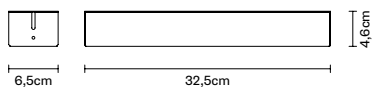

Senza alimentatore  
/ *Without driver*

**F44M0202** 8x6,5x3,6cm

ERIC IP40

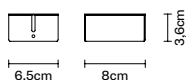

\* Sono compresi 2 attacchi a soffitto filettati e 4 tappi di chiusura per codice  
\* *Each code includes 2 ceiling fastening kits and 4 closure caps*

#### 4. Accessori disponibili / Available accessories

**F44Z01C202**

Ganascia di fissaggio / Fastening joint

**F44Z0302**

Spezzafilo con interruttore / Power plug with switch

#### 5. Il sistema / The system

Personalizza la posizione delle barre e delle luci.  
Customize bars and spots position.

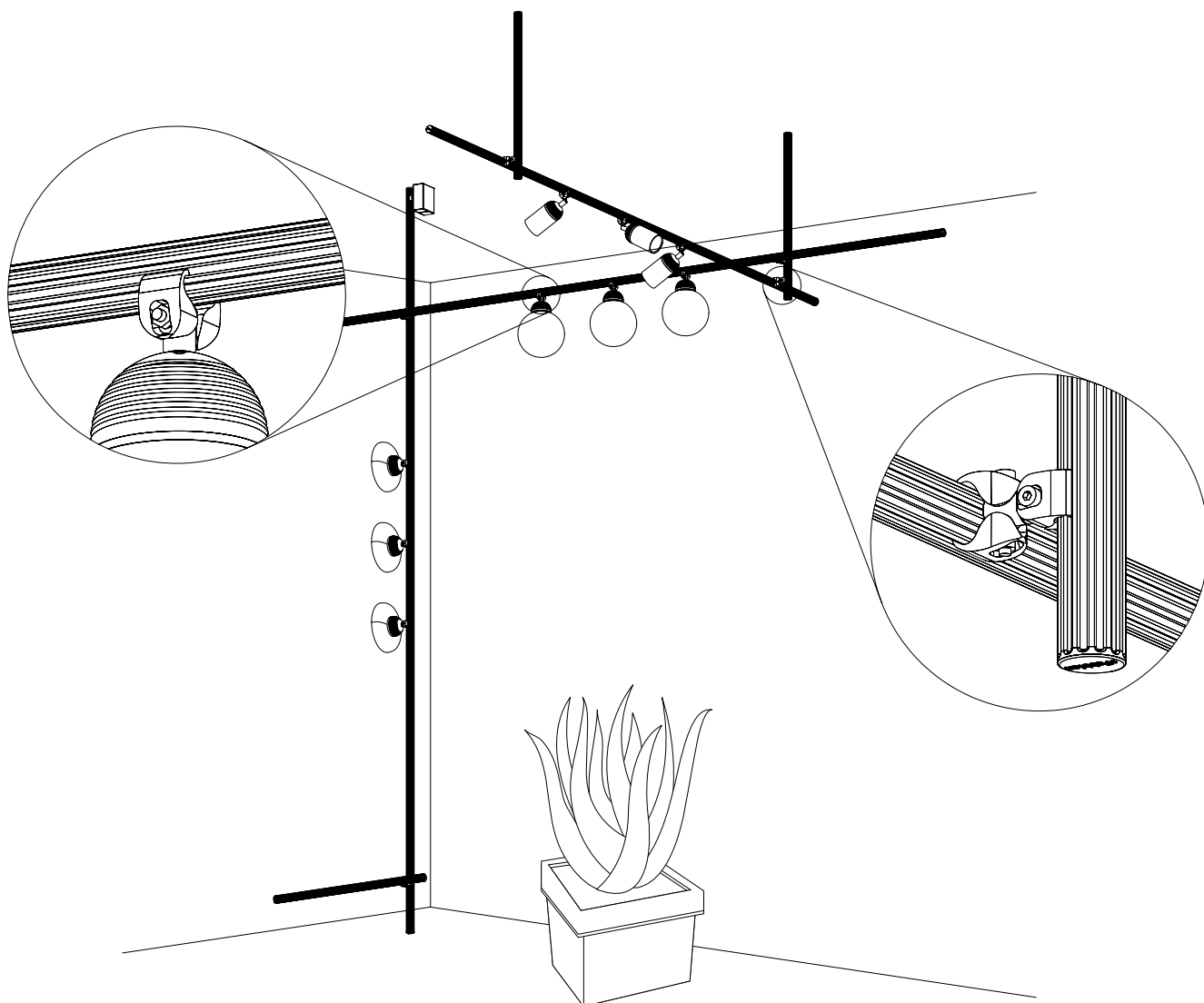

# LAMINIS



FE Design

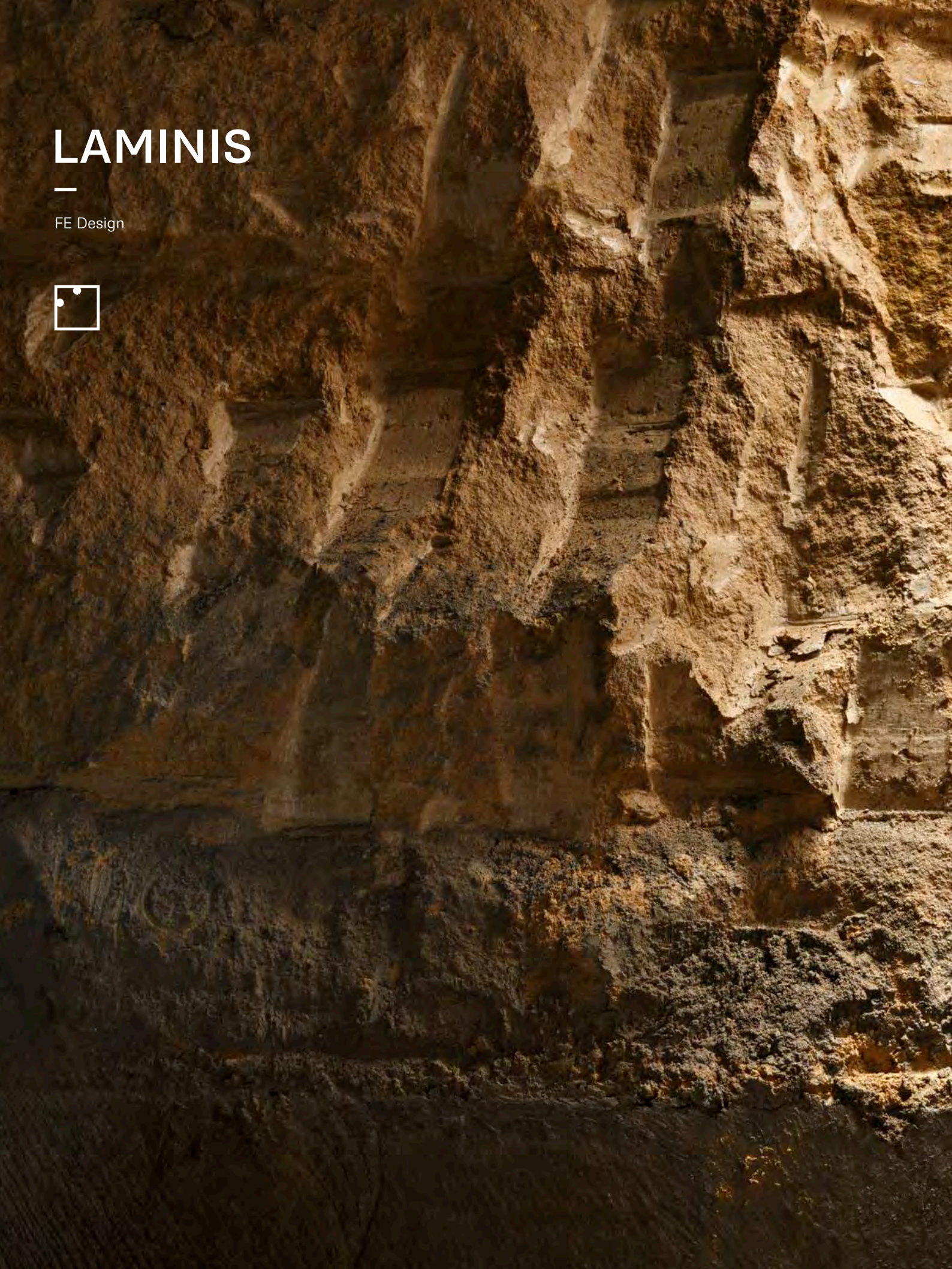







# CONCEPT

---

L'obiettivo dei designer FE Design per questo progetto è stato quello di creare un oggetto per disegnare lo spazio con la luce. Le singole formelle, combinate tra loro come le tessere di un mosaico prezioso, creano strutture luminose poliedriche, che arricchiscono in maniera discreta ogni ambiente aprendo nuovi scenari per qualsiasi progetto architettonico. Questa è la caratteristica principale di Laminis: la naturalezza con cui si sovrappone armonicamente allo spazio esistente, creando infinite trame di luce. Grande attenzione è stata data alla produzione dei vetri, che vengono realizzati interamente a mano da maestri vetrai colando il vetro fuso e successivamente pressandolo secondo disegni stabiliti. L'eventuale coloratura avviene spargendo scaglie colorate sul piano di lavoro.

In this project, the aim of the designers at FE Design was to create an object that would design space with light. The single tiles, combined together like a precious mosaic, create multi-sided luminous structures discretely enriching each ambient and opening scenarios for any architectural project. This is the main characteristic of Laminis: its casual, harmonious overlapping of existing space creating infinite light weaves. Great attention was placed on the production of the glass panels, that are made entirely by hand by master glass-makers, with melted glass which is moulded and form the set designs. Colour is added where needed by scattering coloured flakes on the work surface.

El objetivo de los diseñadores FE Design para este proyecto es crear un objeto para diseñar el espacio con la luz. Las placas individuales, combinadas entre sí al igual que las piezas un mosaico precioso, crean estructuras luminosas poliédricas, que enriquecen discretamente todos los ambientes y abren nuevos escenarios para cualquier proyecto arquitectónico. Ésta es la característica principal de Laminis: la naturaleza con la que se superpone armónicamente en el espacio existente para crear tramas de luz. Se ha prestado una gran atención a la producción de los elementos de vidrio, que se realizan totalmente a mano por parte de maestros vidrieros al vaciar el vidrio fundido que, posteriormente, es prensado según diseños establecidos. El color se obtiene al esparcir escamas de color en la superficie de trabajo.

Das Ziel der Designer FE Design für dieses Projekt war die Erschaffung eines Gegenstands, um den Raum mit Licht zu zeichnen. Die einzelnen, untereinander wie ein wertvolles Mosaik verbundenen Leisten bilden polyedrische Leuchtstrukturen, die jede Umgebung diskret bereichern und in jedem architektonischen Projekt neue Szenen eröffnen. Das ist die Haupteigenschaft von Laminis: Die Natürlichkeit, mit der sie sich harmonisch im bestehenden Raum einfügt und unendliche Lichtmuster erzeugt. Eine hohe Beachtung wurde der Produktion der Gläser geschenkt, die vollständig von Glasmeistern von Hand verwirklicht werden, indem flüssiges Glas gegossen und daraufhin nach festgesetzten Zeichnungen gepresst wird. Die eventuelle Färbung erfolgt durch Zerstreuen von farbigen Splintern auf die Arbeitsfläche.

Pour ce projet, les designers FE Design ont poursuivi l'objectif de créer un objet pour dessiner l'espace avec la lumière. Tous les carreaux, combinés entre eux comme les tesselles d'une mosaïque précieuse, créent des structures lumineuses polyédriques, qui enrichissent discrètement toutes les pièces en ouvrant de nouveaux horizons à tout projet architectonique. Voilà la caractéristique principale de Laminis: le naturel avec lequel elle se superpose à l'espace existant, tout en créant des jeux de lumière infinis. Une grande attention a été dédiée à la production des verres qui sont entièrement réalisés à la main par des maîtres verriers en coulant le verre fondu, puis en le pressant conformément aux dessins établis. Les éventuelles touches de couleur sont appliquées en disséminant des éléments colorés sur la table de travail.

При работе над проектом Laminis целью дизайнеров FE Design было создание предмета, разделяющего пространство собственным светом. Отдельные пластины, собранные вместе как драгоценная мозаика, создают многогранные структуры света, которые сдержанно обогащают любое пространство и открывают новые горизонты для архитектурных проектов. Это и является главной характеристикой Laminis: естественность, с которой он заполняет пространство, создавая бесконечные текстуры света. Большое внимание уделено производству стекол, мастера-стеклодувы выливают жидкое стекло на поверхность и оттискивают пресс-формы с выбранными узорами. Покраска, при необходимости, происходит разбросом цветной стружки на рабочей поверхности.

# LAMINIS

La collezione si costituisce di strutture componibili in metallo da soffitto e parete per interno. Le soluzioni compositive sono illimitate e personalizzabili, a due o un velo elettrificato o ad un velo non elettrificato. Le sospensioni sono in metallo cromato lucido e dorato, le barre modulari sono disponibili con rivestimenti in alluminio brillantato e alluminio dorato. Cavi in acciaio inox sorreggono i vetri, di diverse misure e fantasie, che, su richiesta, sono disponibili anche in colorazioni diverse. L'elettrificazione è a tensione di rete per lampade alogene e per LED.

La colección está constituida por estructuras modulares de metal para techo y pared de interior. Las soluciones de composición son ilimitadas y personalizables, con dos cortinas de vidrio o una electrificada o con una cortina de vidrio no electrificada. Las lámparas colgantes son de metal cromado brillante y dorado, las barras modulares están disponibles con revestimiento de aluminio abrillantado y aluminio dorado. Cables de acero inoxidable soportan los elementos de vidrio, con distintas medidas y fantasías, que, bajo pedido, existen también en colores diferentes. La electrificación es con tensión de red para bombillas halógenas y para LED.

Die Kollektion besteht aus zusammensetzbaren Strukturen aus Metall für die Wand- und Deckenausführung für Innenbereiche. Die zusammensetzbare Lösungen sind unbegrenzt und individuell gestaltbar, mit zwei oder einer elektrifizierten Glaswand oder einer nicht elektrifizierten Glaswand. Die Hängelampen sind aus glanzverchromten und vergoldetem Metall, die modularen Stangen sind mit Beschichtungen aus poliertem Alu und vergoldetem Alu erhältlich. Kabel aus Edelstahl halten die Gläser in verschiedenen Abmessungen und Mustern, die auf Wunsch auch in unterschiedlichen Farben erhältlich sind. Die Elektrifizierung erfolgt über Netzspannung für Halogen- und LED-Lampen.

The collection is composed of modular ceiling and wall lamp models for indoor use, with a metal structure. The possible layouts are endless, and may consist of one or two electrically powered "veils", or just one "veil", without electrical power. The hanging lamp models are in polished chrome / gilded metal; the modular strips are available in either polished or gilded aluminium. The glass panels, in different sizes and patterns, are supported by means of stainless steel cables, and are also available in different colours on request. The lamps run on mains power and are suitable for halogen and LED bulbs.

La collection est constituée par des structures modulables en métal pour plafond et par des appliques pour intérieur. Les solutions de compositions sont illimitées et peuvent être personnalisées à deux ou un voile électrifié ou à un voile non électrifié. Les suspensions sont en métal chromé brillant et doré, les barres modulaires sont disponibles avec des revêtements en aluminium brillant et doré. Des câbles en acier inox supportent les verres, de diverses mesures et fantasies, ils sont également disponibles avec différentes couleurs. Les lampes halogènes et LED sont alimentées par la tension du réseau.

Коллекция состоит из металлических структур для крепления к потолку или к стене, для внутренних помещений. Неограниченные возможности композиции и уникального монтажа, возможность выбрать между одинарной или двойной завесой из электрифицированных пластин или одинарной завесой из неэлектрифицированных пластин. Подвески из блестящего хромированного и позолоченного металла, модульные перекладины из полированного или позолоченного алюминия. Тросы из нержавеющей стали держат стекла разных размеров и с разными узорами, которые могут производиться также в разных цветах. Электрическая часть рассчитана на галогеновые и светодиодные лампы от сетевого напряжения.









# LAMINIS

Sorgente: GU10 / *Light source: GU10*

Configurazione: 1 o 2 pareti / *Layout: 1 or 2 glass walls*

## 1. Scelta barra e angoli / *Metal bar and angle option*

### 1a. Barre lineari / *Linear bars*

Lunghezza minima: 30 cm  
Modularità ogni 30 cm  
Elettrificazione ogni 30 cm (2x50W GU10)  
Su richiesta sono disponibili elettrificazioni diverse.  
Ogni sistema deve prevedere l'utilizzo di un modulo da 30 cm di partenza.  
I moduli starter sono moduli cablati per l'alimentazione di partenza.

*Minimum length: 30 cm  
30 cm modularity  
Electrification every 30 cm (2x50W GU10)  
Different electrification are available on request.  
Each system has to use a 30 cm starter module.  
The starter modules are electrified.*

**F33M1163** 30 cm (Starter)  
**F33M1263** 30 cm (Modulo / *Module*)  
**F33M1363** 60 cm (Modulo / *Module*)  
**F33M1463** 90 cm (Modulo / *Module*)  
**F33M1563** 120 cm (Modulo / *Module*)

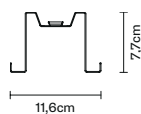
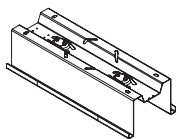

### 1b. Coppia di tappi / *Couple of caps*

Alluminio brillantato / *Polished aluminium*  
**F33Z2015**

Alluminio dorato / *Golden aluminium*  
**F33Z2012**

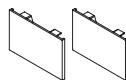

### 1c. Kit parete / *Wall kit*

Lunghezza minima: 30 cm  
Modularità ogni 30 cm  
Per la versione a parete vanno aggiunte alle barre lineari indicate qui a lato (F33M1...) uno dei seguenti kit in base alla lunghezza desiderata.

*Minimum length: 30 cm  
30 cm modularity  
For the wall version, it must be added to the linear bars indicated at right (F33M1...) one of the following kits according to the desired length.*

**F33Z0263** 30 cm  
**F33Z0363** 60 cm  
**F33Z0463** 90 cm  
**F33Z0563** 120 cm

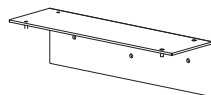

### 1d. Barra ad angolo / *Angle bar*

**F33M1663** 30x30 cm (Starter)

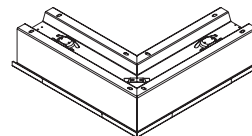

### 1d. Barra quadrata / *Square bar*

**F33M1763** 30x30 cm (Starter)

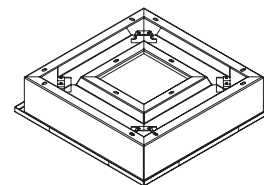



## 2. Scelta fasce di rivestimento / Cover options

Alluminio brillantato / Polished aluminium

**F33Z1027** 30 cm  
**F33Z1127** 60 cm  
**F33Z1227** 90 cm  
**F33Z1327** 120 cm  
**F33Z1427** 150 cm  
**F33Z1527** 180 cm  
**F33Z1627** 19,1 cm

Alluminio dorato / Golden aluminium

**F33Z1074** 30 cm  
**F33Z1174** 60 cm  
**F33Z1274** 90 cm  
**F33Z1374** 120 cm  
**F33Z1474** 150 cm  
**F33Z1574** 180 cm  
**F33Z1674** 19,1 cm

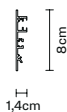
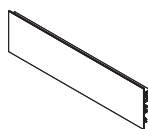

## 3. Scelta vetri\* / Glass options\*



**Cerchio / F33V01C200**  
29x23 cm

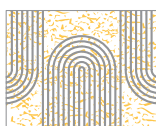

**Cerchio / F33V01C247**  
29x23 cm



**Riga / F33V02C400**  
29x11 cm



**Riga / F33V02C447**  
29x11 cm



**Onda / F33V03C400**  
29x11 cm



**Rombo / F33V04C400**  
29x11 cm

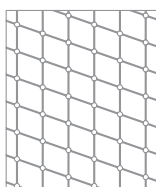

**Quadro / F33V05C200**  
29x35 cm



**Ponte / F33V06C400**  
29x11 cm



**Riga / F33V07C400**  
19x11 cm

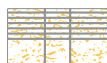

**Riga / F33V07C447**  
19x11 cm

## 4. Cavi di sostegno / Support cable

I cavi di sostegno (F33Z49) verranno consegnati in base alla disposizione compositiva, della quale devono essere indicate il numero di vetri e il numero degli spazi vuoti interni alla composizione.

*The support cables (F33Z49) delivery is based on the building option preferred, of which the number of glasses and interior empty spaces has to be specified.*

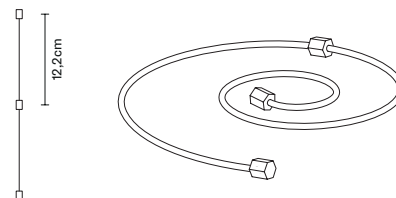

## 5. Ferma cavi di sicurezza / Security cable fastener

Nel caso in cui si raggiunga un'altezza superiore a 200 cm dovrà essere ordinato necessariamente il ferma cavo di sicurezza (F33Z48C08), nella misura di 1 per ogni cavo d'acciaio.

*In case the composition length were higher than cm 200 one security cable fastener (F33Z48C08) for each stainless steel cable has to be ordered.*

\* Su richiesta altre colorazioni (visualizzabili sul sito e/o sul Catalogo Generale) e disegni.

\* Other colours (that you can browse on the website or on the General Catalogue) and drawings by request.



# LAMINIS

Sorgente: LED BAR / *Light source: LED BAR*

Configurazione: 1 o 2 pareti / *Layout: 1 or 2 glass walls*

## 1. Scelta barra e angoli / *Metal bar and angle option*

### 1a. Barre lineari / *Linear bars*

Lunghezza minima: 30 cm  
Modularità ogni 30 cm  
Ogni barra è compresa di 4 ferma cavo di sicurezza.  
Ogni alimentatore è dimmerabile e supporta max 12 barre LED.

*Minimum length: 30 cm  
30 cm modularity  
4 security cable fasteners are included in each bar.  
Each driver is dimmable and supports max 12 LED bar.*

**F33M0163** 30 cm  
(Starter, Alim. non incluso / Alim. not included)

**F33M0263** 30 cm  
(Starter, 1 Alim. dim. incluso / 1 Alim. dim. included)

**F33M0363** 30 cm  
(Starter, 2 Alim. dim. incluso / 2 Alim. dim. included)

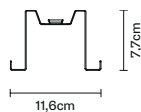
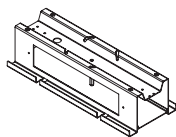

### 1b. Coppia di tappi / *Couple of caps*

Alluminio brillantato / *Polished aluminium*  
**F33Z2015**

Alluminio dorato / *Golden aluminium*  
**F33Z2012**

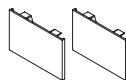

### 1c. Kit parete / *Wall kit*

Lunghezza minima: 30 cm  
Modularità ogni 30 cm  
Per la versione a parete vanno aggiunte alle barre lineari indicate qui a lato (F33M0...) il seguente kit in base alla lunghezza desiderata.

*Minimum length: 30 cm  
30 cm modularity  
For the wall version, it must be added to the linear bars indicated at right (F33M0...) the following kit according to the desired length.*

**F33Z0263** 30 cm  
**F33Z0363** 60 cm  
**F33Z0463** 90 cm  
**F33Z0563** 120 cm

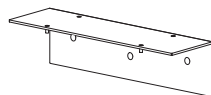

### 1d. Barra ad angolo / *Angle bar*

Ogni alimentatore è dimmerabile e supporta max 12 barre LED.  
*Each driver is dimmable and supports max 12 LED bar.*

**F33M0663** 30x30 cm  
(Starter, 2 Alim. dim. incluso / 2 Alim. dim. included)

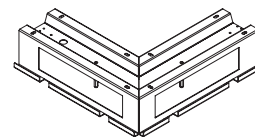

### 1d. Barra quadrata / *Square bar*

Ogni alimentatore è dimmerabile e supporta max 12 barre LED.  
*Each driver is dimmable and supports max 12 LED bar.*

**F33M0763** 30x30 cm  
(Starter, 4 Alim. dim. incluso / 4 Alim. dim. included)

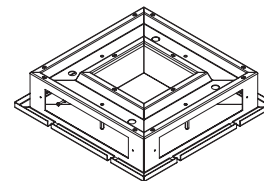

## 2. Scelta fasce di rivestimento / Cover options

Alluminio brillantato / Polished aluminium

**F33Z1027** 30 cm  
**F33Z1127** 60 cm  
**F33Z1227** 90 cm  
**F33Z1327** 120 cm  
**F33Z1427** 150 cm  
**F33Z1527** 180 cm  
**F33Z1627** 19,1 cm

Alluminio dorato / Golden aluminium

**F33Z1074** 30 cm  
**F33Z1174** 60 cm  
**F33Z1274** 90 cm  
**F33Z1374** 120 cm  
**F33Z1474** 150 cm  
**F33Z1574** 180 cm  
**F33Z1674** 19,1 cm

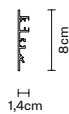

## 3. Scelta vetri\* / Glass options\*



**Cerchio / F33V01C200**  
29x23 cm

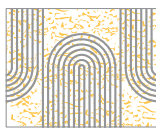

**Cerchio / F33V01C247**  
29x23 cm



**Riga / F33V02C400**  
29x11 cm

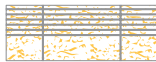

**Riga / F33V02C447**  
29x11 cm



**Onda / F33V03C400**  
29x11 cm



**Rombo / F33V04C400**  
29x11 cm

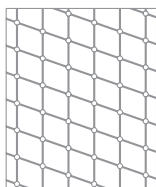

**Quadro / F33V05C200**  
29x35 cm



**Ponte / F33V06C400**  
29x11 cm



**Riga / F33V07C400**  
19x11 cm

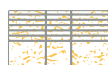

**Riga / F33V07C447**  
19x11 cm

## 4. Cavi di sostegno / Support cable

I cavi di sostegno (F33Z49) verranno consegnati in base alla disposizione compositiva, della quale devono essere indicate il numero di vetri e il numero degli spazi vuoti interni alla composizione.

*The support cables (F33Z49) delivery is based on the building option preferred, of which the number of glasses and interior empty spaces has to be specified.*

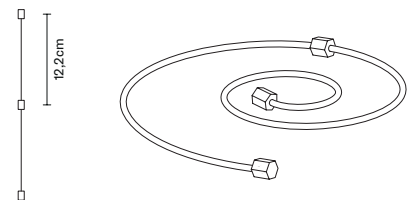

## 5. Sorgente luminosa a LED / LED light source

**F33Z51** 5W 24Vdc 2700K 400lm CRI 80

Ogni alimentatore è dimmerabile 1..10V e supporta max 12 barre LED. Altri tipi di dimmerazione su richiesta.

*Each driver is dimmable 1..10V and supports max 12 LED bar. Other kind of dimming by request.*

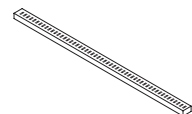

\* Su richiesta altre colorazioni (visualizzabili sul sito e/o sul Catalogo Generale) e disegni.

*\* Other colours (that you can browse on the website or on the General Catalogue) and drawings by request.*

# LAMINIS

Sorgente: LED STRIP / *Light source: LED STRIP*

Configurazione: 1 o 2 pareti / *Layout: 1 or 2 glass walls*

## 1. Scelta barra e angoli / *Metal bar and angle option*

### 1a. Barre lineari / *Linear bars*

Lunghezza minima: 30 cm  
Modularità ogni 30 cm  
LED e driver non inclusi.

*Minimum length: 30 cm  
30 cm modularity  
LED and driver not included.*

**F33M2263** 30 cm  
**F33M2363** 60 cm  
**F33M2463** 90 cm  
**F33M2563** 120 cm

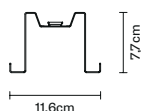
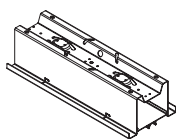

### 1b. Coppia di tappi / *Couple of caps*

Alluminio brillantato / *Polished aluminium*  
**F33Z2015**

Alluminio dorato / *Golden aluminium*  
**F33Z2012**

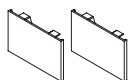

### 1c. Kit parete / *Wall kit*

Lunghezza minima: 30 cm  
Modularità ogni 30 cm  
Per la versione a parete vanno aggiunte alle barre lineari indicate qui a lato (F33M2...) uno dei seguenti kit in base alla lunghezza desiderata.

*Minimum length: 30 cm  
30 cm modularity  
For the wall version, it must be added to the linear bars indicated at right (F33M2...) one of the following kits according to the desired length.*

**F33Z0263** 30 cm  
**F33Z0363** 60 cm  
**F33Z0463** 90 cm  
**F33Z0563** 120 cm

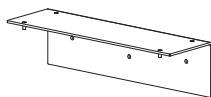

### 1d. Barra ad angolo / *Angle bar*

**F33M2663** 30x30 cm (Starter)

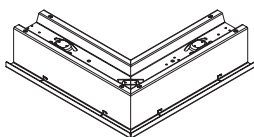

### 1d. Barra quadrata / *Square bar*

**F33M2763** 30x30 cm

LED e driver non inclusi.  
*LED and driver not included.*

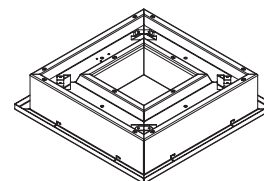

## 2. Scelta fasce di rivestimento / *Cover options*

Alluminio brillantato / *Polished aluminium*

**F33Z1027** 30 cm  
**F33Z1127** 60 cm  
**F33Z1227** 90 cm  
**F33Z1327** 120 cm  
**F33Z1427** 150 cm  
**F33Z1527** 180 cm  
**F33Z1627** 19,1 cm

Alluminio dorato / *Golden aluminium*

**F33Z1074** 30 cm  
**F33Z1174** 60 cm  
**F33Z1274** 90 cm  
**F33Z1374** 120 cm  
**F33Z1474** 150 cm  
**F33Z1574** 180 cm  
**F33Z1674** 19,1 cm

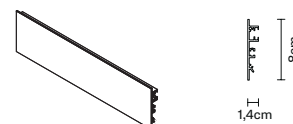

### 3. Scelta vetri\* / Glass options\*

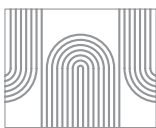

**Cerchio / F33V01C200**  
29x23 cm

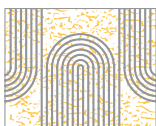

**Cerchio / F33V01C247**  
29x23 cm



**Riga / F33V02C400**  
29x11 cm

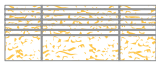

**Riga / F33V02C447**  
29x11 cm

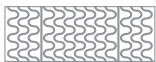

**Onda / F33V03C400**  
29x11 cm



**Rombo / F33V04C400**  
29x11 cm

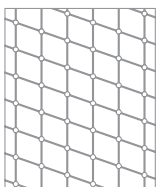

**Quadro / F33V05C200**  
29x35 cm



**Ponte / F33V06C400**  
29x11 cm



**Riga / F33V07C400**  
19x11 cm



**Riga / F33V07C447**  
19x11 cm

\* Su richiesta altre colorazioni (visualizzabili sul sito e/o sul Catalogo Generale) e disegni.

\* Other colours (that you can browse on the website or on the General Catalogue) and drawings by request.

### 4. Cavi di sostegno / Support cable

I cavi di sostegno (F33Z49) verranno consegnati in base alla disposizione compositiva, della quale devono essere indicate il numero di vetri e il numero degli spazi vuoti interni alla composizione.

*The support cables (F33Z49) delivery is based on the building option preferred, of which the number of glasses and interior empty spaces has to be specified.*

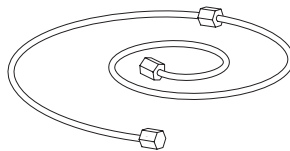
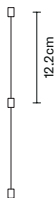

### 5. Ferma cavi di sicurezza / Security cable fastener

Nel caso in cui si raggiunga un'altezza superiore a 200 cm dovrà essere ordinato necessariamente il ferma cavo di sicurezza (F33Z48C08), nella misura di 1 per ogni cavo d'acciaio.

*In case the composition length were higher than cm 200 one security cable fastener (F33Z48C08) for each stainless steel cable has to be ordered.*



### 6. Sorgente luminosa a LED e lente / LED and lens light source

**F33Z53** LED Strip 24Vdc 3000K Cri 80  
23W 2600 lm al metro / by meter  
**F33Z55** LED Lens 30°

Vendute al metro.  
Specificare le lunghezze delle singole tratte lineari.

*Sold by meter.  
Specify the lengths of the single linear section.*

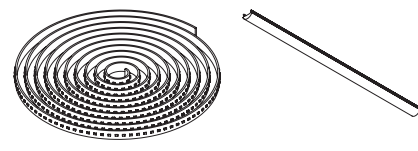

### 7. Alimentazione / Power supply

Selegiere l'alimentatore a tensione costante adeguato alla misura del tratto lineare:

A50202 20W 24Vdc, dimm. 1..10V (max 30cm)  
A50203 25W 24Vdc, dimm. 1..10V (max 60cm)  
A50204 40W 24Vdc, dimm. 1..10V (max 120cm)  
A50205 60W 24Vdc, dimm. 1..10V (max 210cm)  
A50206 90W 24Vdc, dimm. 1..10V (max 300cm)  
A50308 Kit per controllo Dali (4 canali d'uscita) e Push (max 300cm)

*Choose the suitable LED power supply constant voltage according to the length of the structure:*

A50202 20W 24Vdc, dimmable 1..10V (max 30cm)  
A50203 25W 24Vdc, dimmable 1..10V (max 60cm)  
A50204 40W 24Vdc, dimmable 1..10V (max 120cm)  
A50205 60W 24Vdc, dimmable 1..10V (max 210cm)  
A50206 90W 24Vdc, dimmable 1..10V (max 300cm)  
A50308 Dali (4 output channel) and Push kit control (max 300cm)

# LAMINIS

Senza sorgente / *No light source*

Configurazione: 1 pareti / *Layout: 1 glass wall*

## 1. Scelta barra e angoli / *Metal bar and angle option*

### 1a. Barre lineari / *Linear bars*

Lunghezza minima: 30 cm  
Modularità ogni 30 cm

*Minimum length: 30 cm  
30 cm modularity*

Alluminio brillantato / *Polished aluminium*

**F33M3263** 30 cm  
**F33M3363** 60 cm  
**F33M3463** 90 cm  
**F33M3563** 120 cm

Alluminio dorato / *Golden aluminium*

**F33M3274** 30 cm  
**F33M3374** 60 cm  
**F33M3474** 90 cm  
**F33M3574** 120 cm

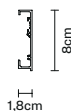
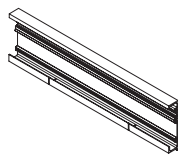

### 1b. Tappi / *Cups*

Alluminio brillantato / *Polished aluminium*

**F33Z2115** Tappo destro / *Right cap*  
**F33Z2215** Tappo sinistro / *Left cap*

Alluminio dorato / *Golden aluminium*

**F33Z2112** Tappo destro / *Right cap*  
**F33Z2212** Tappo sinistro / *Left cap*



## 2. Scelta fasce di rivestimento / *Cover options*

Alluminio brillantato / *Polished aluminium*

**F33Z1027** 30 cm  
**F33Z1127** 60 cm  
**F33Z1227** 90 cm  
**F33Z1327** 120 cm  
**F33Z1427** 150 cm  
**F33Z1527** 180 cm  
**F33Z1627** 19,1 cm

Alluminio dorato / *Golden aluminium*

**F33Z1074** 30 cm  
**F33Z1174** 60 cm  
**F33Z1274** 90 cm  
**F33Z1374** 120 cm  
**F33Z1474** 150 cm  
**F33Z1574** 180 cm  
**F33Z1674** 19,1 cm

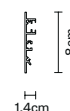
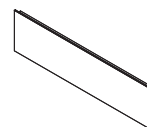

### 3. Scelta vetri\* / Glass options\*



**Cerchio / F33V01C200**  
29x23 cm



**Cerchio / F33V01C247**  
29x23 cm



**Riga / F33V02C400**  
29x11 cm



**Riga / F33V02C447**  
29x11 cm



**Onda / F33V03C400**  
29x11 cm



**Rombo / F33V04C400**  
29x11 cm

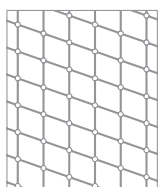

**Quadro / F33V05C200**  
29x35 cm



**Ponte / F33V06C400**  
29x11 cm



**Riga / F33V07C400**  
19x11 cm



**Riga / F33V07C447**  
19x11 cm

### 4. Cavi di sostegno / Support cable

I cavi di sostegno (F33Z49) verranno consegnati in base alla disposizione compositiva, della quale devono essere indicate il numero di vetri e il numero degli spazi vuoti interni alla composizione.

*The support cables (F33Z49) delivery is based on the building option preferred, of which the number of glasses and interior empty spaces has to be specified.*

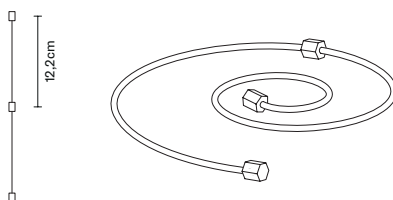

### 5. Ferma cavi di sicurezza / Security cable fastener

Nel caso in cui si raggiunga un'altezza superiore a 200 cm dovrà essere ordinato necessariamente il ferma cavo di sicurezza (F33Z48C08), nella misura di 1 per ogni cavo d'acciaio.

*In case the composition length were higher than cm 200 one security cable fastener (F33Z48C08) for each stainless steel cable has to be ordered.*



\* Su richiesta altre colorazioni (visualizzabili sul sito e/o sul Catalogo Generale) e disegni.

\* Other colours (that you can browse on the website or on the General Catalogue) and drawings by request.

# LAMINIS

Sorgente: LED STRIP / *Light source: LED STRIP*

Configurazione: 1 parete / *Layout: 1 glass wall*

## 1. Scelta barra e angoli / *Metal bar and angle option*

### 1a. Barre lineari / *Linear bars*

Lunghezza minima: 30 cm  
Modularità ogni 30 cm  
LED e driver non inclusi.

*Minimum length: 30 cm  
30 cm modularity  
LED and driver not included.*

**F33M4263** 30 cm  
**F33M4363** 60 cm  
**F33M4463** 90 cm  
**F33M4563** 120 cm

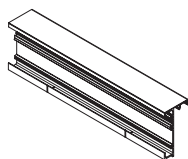

### 1b. Tappi / *Cups*

Alluminio brillantato / *Polished aluminium*  
**F33Z2115** Tappo destro / *Right cap*  
**F33Z2215** Tappo sinistro / *Left cap*

Alluminio dorato / *Golden aluminium*  
**F33Z2112** Tappo destro / *Right cap*  
**F33Z2212** Tappo sinistro / *Left cap*



## 2. Scelta fasce di rivestimento / *Cover options*

Alluminio brillantato / *Polished aluminium*

**F33Z1027** 30 cm  
**F33Z1127** 60 cm  
**F33Z1227** 90 cm  
**F33Z1327** 120 cm  
**F33Z1427** 150 cm  
**F33Z1527** 180 cm  
**F33Z1627** 19,1 cm

Alluminio dorato / *Golden aluminium*

**F33Z1074** 30 cm  
**F33Z1174** 60 cm  
**F33Z1274** 90 cm  
**F33Z1374** 120 cm  
**F33Z1474** 150 cm  
**F33Z1574** 180 cm  
**F33Z1674** 19,1 cm

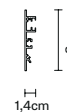
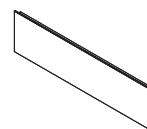



### 3. Scelta vetri\* / Glass options\*



**Cerchio / F33V01C200**  
29x23 cm



**Cerchio / F33V01C247**  
29x23 cm



**Riga / F33V02C400**  
29x11 cm



**Riga / F33V02C447**  
29x11 cm



**Onda / F33V03C400**  
29x11 cm



**Rombo / F33V04C400**  
29x11 cm

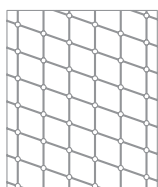

**Quadro / F33V05C200**  
29x35 cm



**Ponte / F33V06C400**  
29x11 cm



**Riga / F33V07C400**  
19x11 cm



**Riga / F33V07C447**  
19x11 cm

\* Su richiesta altre colorazioni (visualizzabili sul sito e/o sul Catalogo Generale) e disegni.

\* Other colours (that you can browse on the website or on the General Catalogue) and drawings by request.

### 4. Cavi di sostegno / Support cable

I cavi di sostegno (F33Z49) verranno consegnati in base alla disposizione compositiva, della quale devono essere indicate il numero di vetri e il numero degli spazi vuoti interni alla composizione.

*The support cables (F33Z49) delivery is based on the building option preferred, of which the number of glasses and interior empty spaces has to be specified.*

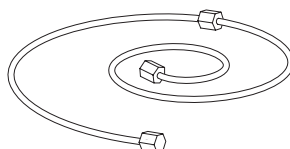
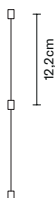

### 5. Ferma cavi di sicurezza / Security cable fastener

Nel caso in cui si raggiunga un'altezza superiore a 200 cm dovrà essere ordinato necessariamente il ferma cavo di sicurezza (F33Z48C08), nella misura di 1 per ogni cavo d'acciaio.

*In case the composition length were higher than cm 200 one security cable fastener (F33Z48C08) for each stainless steel cable has to be ordered.*



### 6. Sorgente luminosa a LED e lente / LED and lens light source

**F33Z53** LED Strip 24Vdc 3000K Cri 80  
23W 2600 lm al metro / *by meter*  
**F33Z55** LED Lens 30°

Vendute al metro.

Specificare le lunghezze delle singole tratte lineari.

*Sold by meter.*

*Specify the lengths of the single linear section.*

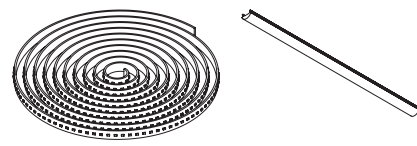

### 7. Alimentazione / Power supply

Segliere l'alimentatore a tensione costante adeguato alla misura del tratto lineare:

A50202 20W 24Vdc, dimm. 1.10V (max 30cm)  
A50203 25W 24Vdc, dimm. 1.10V (max 60cm)  
A50204 40W 24Vdc, dimm. 1.10V (max 120cm)  
A50205 60W 24Vdc, dimm. 1.10V (max 210cm)  
A50206 90W 24Vdc, dimm. 1.10V (max 300cm)  
A50308 Kit per controllo Dali (4 canali d'uscita)  
e Push (max 300cm)

*Choose the suitable LED power supply constant voltage according to the length of the structure:*

A50202 20W 24Vdc, dimmable 1.10V (max 30cm)  
A50203 25W 24Vdc, dimmable 1.10V (max 60cm)  
A50204 40W 24Vdc, dimmable 1.10V (max 120cm)  
A50205 60W 24Vdc, dimmable 1.10V (max 210cm)  
A50206 90W 24Vdc, dimmable 1.10V (max 300cm)  
A50308 Dali (4 output channel) and Push kit  
control (max 300cm)

# LAMINIS

My Glass  
CUSTOM BASE

- 1.** Il percorso di personalizzazione inizia con la scelta dei vetri Laminis che andranno a formare la parete.\*

*The customization path starts with the choice of Laminis glasses which will form the glass wall.\**

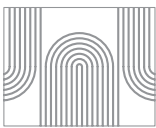

**Cerchio / F33V01C200**  
29x23 cm

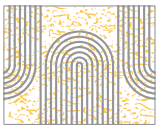

**Cerchio / F33V01C247**  
29x23 cm



**Riga / F33V02C400**  
29x11 cm



**Riga / F33V02C447**  
29x11 cm



**Onda / F33V03C400**  
29x11 cm



**Rombo / F33V04C400**  
29x11 cm

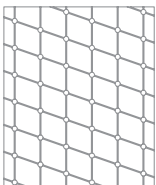

**Quadro / F33V05C200**  
29x35 cm



**Ponte / F33V06C400**  
29x11 cm



**Riga / F33V07C400**  
19x11 cm

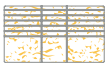

**Riga / F33V07C447**  
19x11 cm

- 2.** Combinandoli si possono ottenere infinite possibilità di personalizzazione.

*Combining them you can get endless customization possibilities.*

EXAMPLE

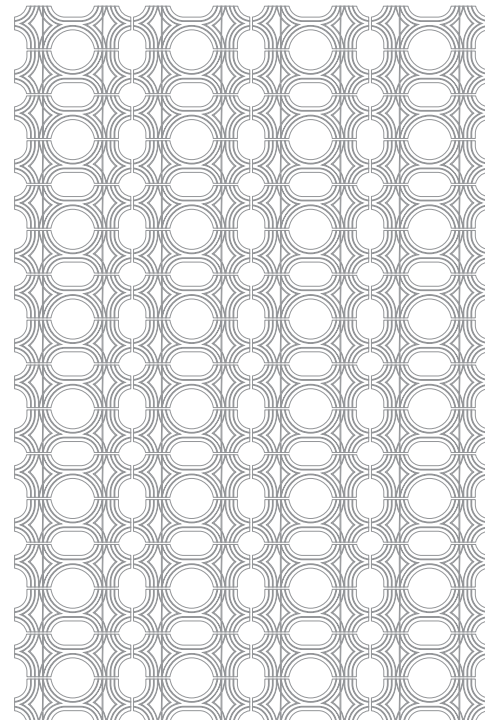

F33V06C400

Fantasia regolare  
*Regular pattern*

# Ogni Laminis sarà unica *Each Laminis will be unique*

EXAMPLE

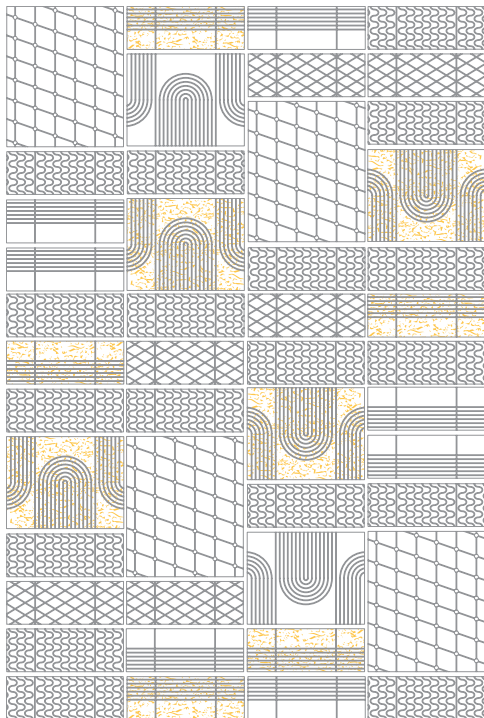

F33V01C200 / F33V01C247 / F33V02C400 / F33V02C447  
F33V03C400 / F33V04C400 / F33V05C200

Mescolanza di diversi vetri  
*Mix of different glasses*

EXAMPLE

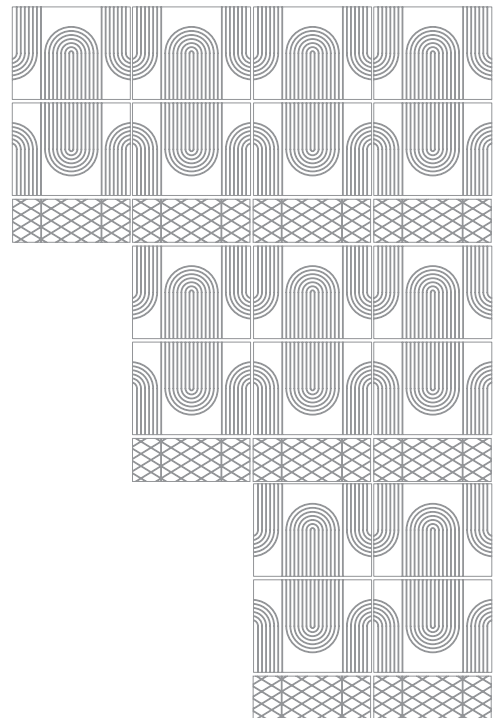

F33V01C200 / F33V04C400

Distribuzione personalizzata dei vetri  
*Custom combination of the glasses*

# LAMINIS

*My Glass*

TOTAL CUSTOM

## DIMENSIONE VETRI / GLASSES DIMENSION

La larghezza di tutti i vetri parte da una base di 30 cm/11 3/4" e si sviluppa in multipli.

*The various glasses must have a width of 30 cm/11 3/4", or multiple, although they have different sizes.*

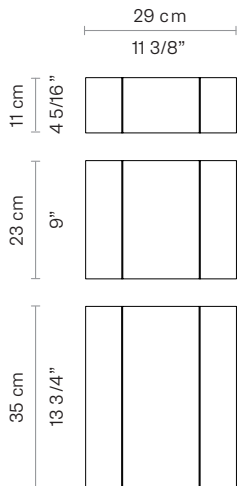

## DISEGNO PERSONALIZZATO / DESIGN IT YOUR SELF

C'è la possibilità di scegliere tra le lavorazioni grafiche del vetro da noi proposte oppure possiamo produrre il motivo grafico disegnato da te.

*You can choose one of our glass patterns or you can create your own design and we'll produce it for you.*

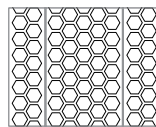

\* Fattibilità dei disegni da verificare in base al processo produttivo vetrario.

\* Feasibility of the designs to be verified according to the glass production process.

# Infinite possibilità Endless Possibilities

## COLORAZIONE / COLOUR

C'è la possibilità di personalizzare la finitura cromatica dei singoli vetri scegliendo tra quelli qui indicati.

*Possibility to choose the colour finishing of the single glasses among those described here.*

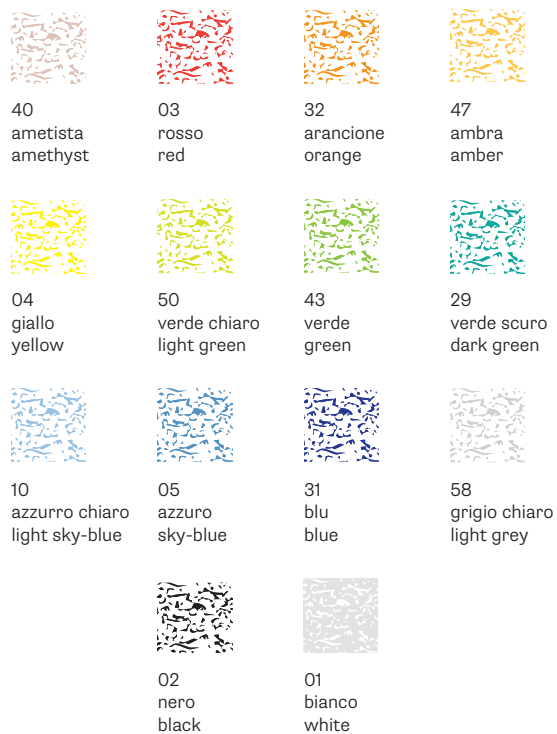

\* Gli stessi colori (visualizzabili sul sito e/o sul Catalogo Generale), fatti a mano, potrebbero subire delle variazioni.

\* The same colours (that you can browse on the website or on the General Catalogue), handmade, could change.

## DISTRIBUZIONE / ARRANGEMENT

C'è la possibilità di scegliere la distribuzione dei singoli vetri.

*Possibility to choose the arrangement of the single glasses.*

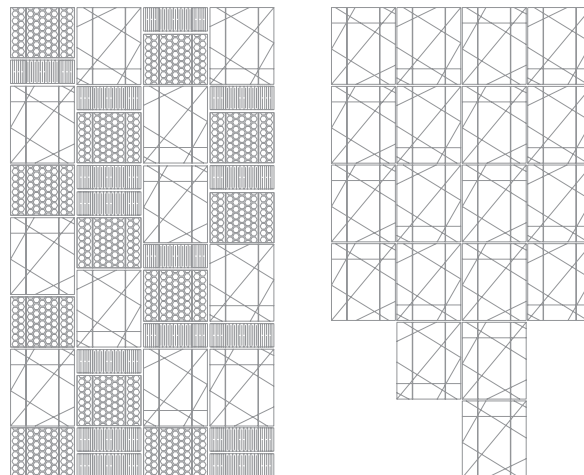



# MONTAGGIO / ASSEMBLY

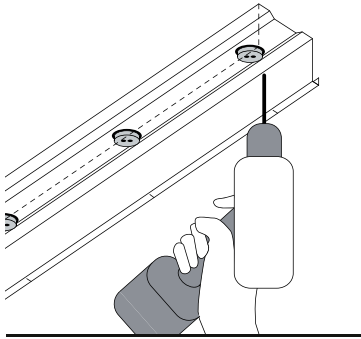

Collegamento elettrico e fissaggio della barra.  
*Electrical connection and bar fastening.*

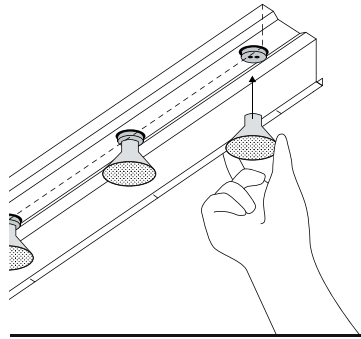

Inserimento delle lampadine.  
*Light bulbs installation.*

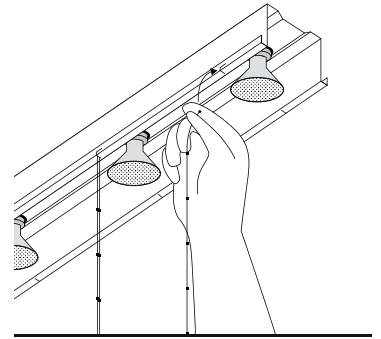

Inserimento dei cavi e loro taglio a misura.  
*Stainless steel cables insertion and cut.*

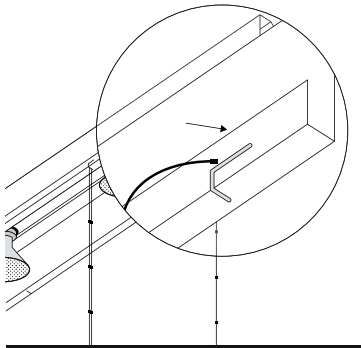

Dettaglio dell'inserimento del cavo.  
*Cable insertion detail.*

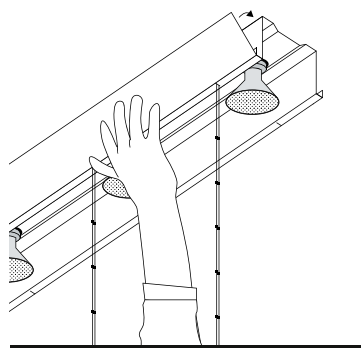

Posizionamento della fascia di rivestimento.  
*Cover assembly.*

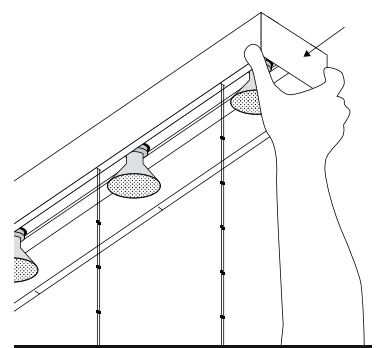

Inserimento dei tappi di chiusura.  
*Locking caps assembly.*

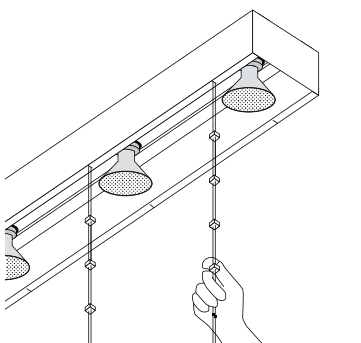

Montaggio dei ferma vetro.  
*Glass fastener assembly.*

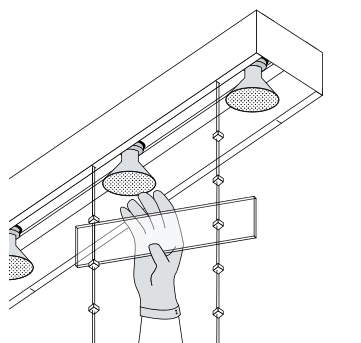

Inserimento degli elementi in vetro cristallino.  
*Glass tiles insertion.*

# METROPOLE



Marc Sadler

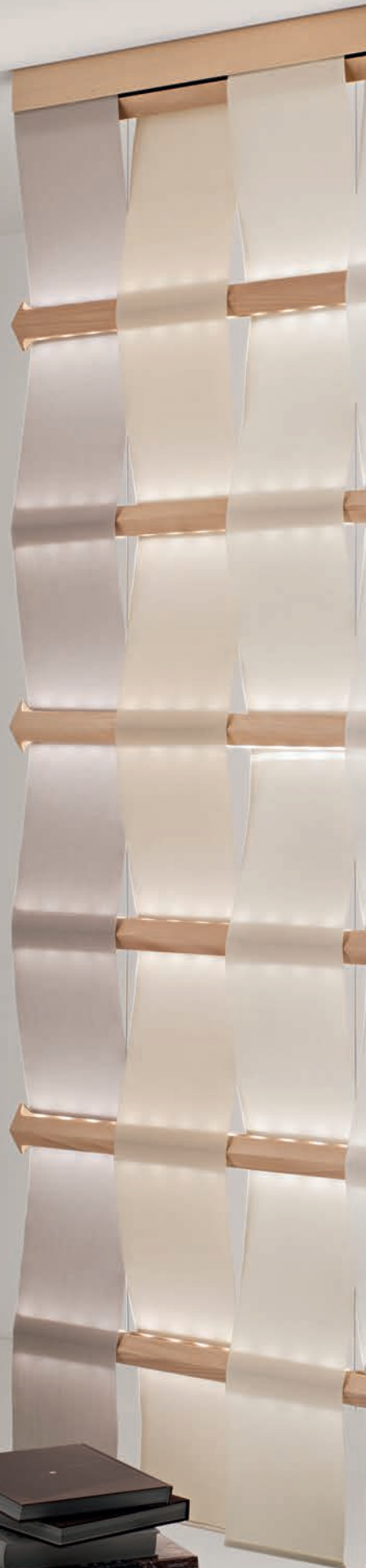







# CONCEPT

---

Metropole, come suggerisce il nome stesso, ricorda le finestre accese dei grattacieli di una metropoli che non si addormenta mai. I grandi edifici sviluppati in verticale, si animano nella notte grazie alla luce che traspare dalle vetrate creando suggestivi puzzle di riflessi. Il rumore e il caos della città vengono attutiti dai materiali naturali di Metropole, il legno e il tessuto fonoassorbente, che fondendosi tra loro in elementi modulari ripartiscono gli spazi arredandoli con la luce.

As the name suggests, Metropole is inspired by the skyscraper windows in a city that never sleeps. The high vertical buildings liven up during the night thanks to the light that seeps through the windows, creating fascinating reflecting puzzles. The city noise and chaos are muffled by Metropole natural materials - wood and sound-absorbing fabric, which, by blending together in modular elements, divide the space decorating it with light.

Metropole, como su nombre sugiere, nos recuerda las ventanas encendidas de los rascacielos de una metrópolis siempre despierta. Los grandes edificios desarrollados en vertical se animan por la noche mediante una luz, que se ve por las cristalerías para crear puzzles mágicos de reflejos. El ruido y el caos de la ciudad se amortiguan con los materiales naturales de Metropole, la madera y el tejido insonorizante que, al fundirse entre sí en elementos modulares, dividen los espacios decorándolos con la luz.

Metropole ist, wie der Name schon sagt, eine Anspielung auf die erleuchteten Fenster der Wolkenkratzer in einer Großstadt, die nie zur Ruhe kommt. Die in den Himmel ragenden Bauten beleben sich in der Nacht dank des Lichts, das durch die Fenster schimmert und malerische Puzzles aus Reflexen entstehen lässt. Der Lärm und das Chaos der Stadt werden von den natürlichen Materialien von Metropole - Holz und schalldämpfendes Gewebe - gemildert, die in modularen Elementen miteinander verschmelzen und den Raum mit Licht gestalten.

Comme le suggère son nom, Metropole évoque les fenêtres éclairées des gratte-ciels d'une métropole qui ne dort jamais. Les grands édifices verticaux s'animent la nuit grâce à la lumière émise par les baies vitrées en formant un gigantesque puzzle de reflets. Le bruit et la confusion de la ville sont atténués par les matériaux naturels de Metropole, le bois et le tissu acoustique, unis dans des éléments modulaires qui répartissent les espaces en les décorant avec la lumière.

Название Metropole напоминает освещенные окна небоскребов никогда не спящего мегаполиса. Многоэтажные здания оживают ночью благодаря свету, который просеивается через окна, создавая паутину отражений. Шум и хаос города передается посредством использования натуральных материалов, как дерево и звукопоглощающая ткань, которые сливаются между собой в модульных элементах, разделяют пространство, создают обстановку с помощью света.

# METROPOLE

Grazie alle sue caratteristiche tecniche ed estetiche, Metropole è particolarmente adatta all'arredo e all'illuminazione di grandi spazi, come lobby di hotel o ristoranti open-space. Si tratta di un sistema modulare composto da listelli in faggio naturale, alternati da un tessuto fonoassorbente e ignifugo. I listelli contengono la sorgente luminosa a LED, che può essere bidirezionale o unidirezionale, a seconda del gioco di luci che si desidera creare. Il tessuto invece è fissato sul listello a soffitto, che contiene il driver, e viene appoggiato in modo alternato sui listelli illuminati.

Por sus características técnicas y estéticas, Metropole resulta especialmente apta para decorar e iluminar grandes espacios, tales como lobby de hoteles o restaurantes open-space. Es un sistema modular, compuesto por listones de haya natural, alternados con un tejido insonorizante e ignífugo. Los listones contienen la fuente luminosa con LED, que puede ser bidireccional o unidireccional, dependiendo del juego de luces que se quiera crear. Sin embargo, el tejido se ha fijado en el listón del techo, que contiene el driver, y se apoya de forma alternada en los listones iluminados.

Dank ihrer technischen und ästhetischen Merkmale eignet sich Metropole besonders gut für die Einrichtung und Beleuchtung von großen Bereichen wie das Foyer eines Hotels oder offen gestaltete Restaurants. Es handelt sich um ein modulares System aus natürlichen Buchenholzleisten im Wechsel mit einem schalldämpfenden und flammenhemmenden Gewebe. Die Holzleisten enthalten uni- oder bidirektionale LED-Leuchtmittel entsprechend den Lichtakzenten, die geschaffen werden sollen. Das Gewebe ist dagegen an einer Deckenleiste angebracht, die den Treiber enthält, und bedeckt abwechselnd die Lichtleisten.

Thanks to its technical and aesthetic characteristics, Metropole is ideal for illuminating large spaces, such as hotel lobbies or open-space restaurants. This modular system comprises natural beechwood laths, alternated by sound-proofing and fireproof fabric. The laths contained the LED light source, which can be bi- or unidirectional, depending on the light effects you wish to create. The fabric is fastened to the ceiling lath, which holds the driver, in an alternating way compared to the lighted laths.

Grâce à ses caractéristiques techniques et esthétiques, Metropole est particulièrement indiqué pour la décoration et l'éclairage de grands espaces, comme les halls d'hôtels ou les restaurants open space. Il s'agit d'un système modulaire composé par des lattes en hêtre naturel qui s'alternent avec un tissu acoustique et ignifuge. Les lattes contiennent la source lumineuse à LED, qui peut être bidirectionnelle ou unidirectionnelle, en fonction du jeu de lumières que l'on désire créer. Le tissu, quant à lui, est fixé sur la latte au plafond qui contient le driver, et est placé sur les lattes éclairées de manière alternée.

Благодаря своим техническим и эстетическим характеристикам, линия Metropole особенно хорошо подходит для отделки и освещения больших пространств, как например вестибюли гостиниц или рестораны open-space. Эта модульная система состоит из листов из натурального бука, чередующихся со звукопоглощающей и огнестойкой тканью. Листы содержат светодиодный источник света, который может быть сосредоточен в одно или в два направления, в зависимости от игры света, которую вы хотите создать. Ткань закреплена к листу на потолке, в котором также размещается драйвер, и поочередно струится вниз по освещенным листам.

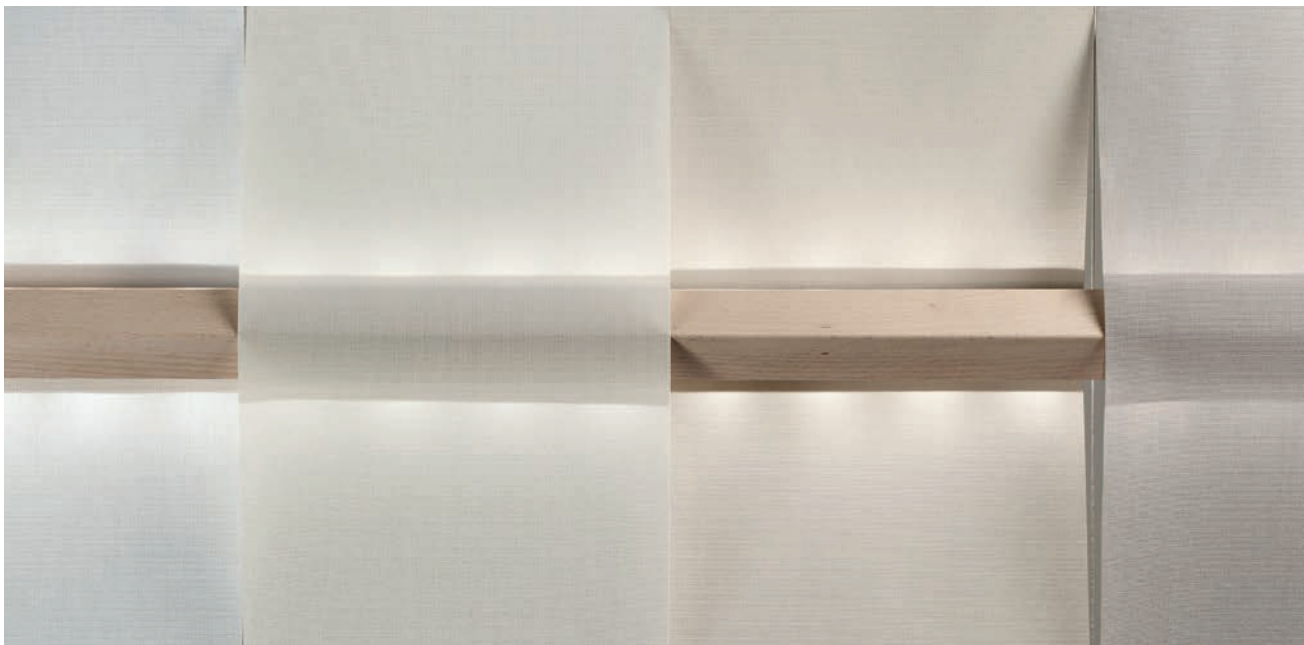

**METROPOLE**

Marc Sadler

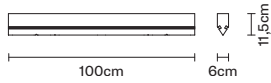

code	electrification	technical info	accessories
<b>NEW!</b> F42 M01 69 Light wood colour		EAC IP20	INCLUDED: - Alimentatore elettronico dimmerabile / Dimmable electronic driver
Listello starter con alimentatore elettronico dimmerabile 60W. Max 14 strip LED / Starter listel with 60W dimmable electronic driver. Max 14 strip LED			

<b>NEW!</b> F42 M02 69 Light wood colour		EAC	
Listello starter senza alimentatore / Starter listel without driver			

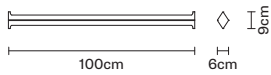

<b>NEW!</b> F42 M11 69 Light wood colour		EAC	
Listello senza sorgente luminosa / Listel without light source			

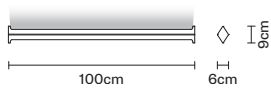

<b>NEW!</b> F42 M12 69 Light wood colour	LED 220-240V 1x4W-120° WHITE 3000K 500lm Cri >80	EAC IP20	INCLUDED: - 1 Strip LED / 1 Strip LED
Listello con strip LED superiore / Listel with upper strip LED			

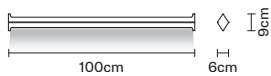

<b>NEW!</b> F42 M13 69 Light wood colour	LED 220-240V 1x4W-120° WHITE 3000K 500lm Cri >80	EAC IP20	INCLUDED: - 1 Strip LED / 1 Strip LED
Listello con strip LED inferiore / Listel with lower strip LED			

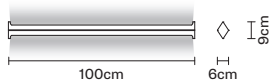

<b>NEW!</b> F42 M14 69 Light wood colour	LED 220-240V 2x4W-120° WHITE 3000K 1000lm Cri >80	EAC IP20	INCLUDED: - 2 Strip LED / 2 Strip LED
Listello con strip LED superiore e inferiore / Listel with upper and lower strip LED			



<b>NEW!</b> F42 V01 01 White 09 Ivory 16 Beige 75 Light grey		EAC	Tela fonoassorbente, ignifuga, autoestinguente larga 25cm. Prezzo al metro. Al momento dell'ordine comunicare all'azienda le misure del progetto / Soundproof, fire-resistant, self-extinguishing canvas 25cm wide. Price for by meter. When ordering, communicate to the company the dimensions of the project
--------------------------------------------------------------------------	--	-----	-----------------------------------------------------------------------------------------------------------------------------------------------------------------------------------------------------------------------------------------------------------------------------------------------------------------



# MONTAGGIO / ASSEMBLY

1.

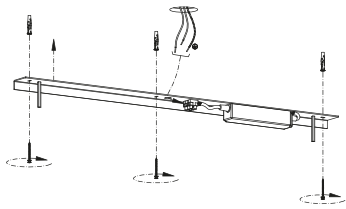

Montare la staffa a soffitto e connettere alla rete.

*Install the metal support on the ceiling and connect the driver to the power.*

2.

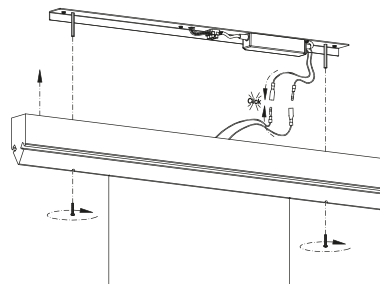

Collegare i connettori elettrici e montare il listello a soffitto.

*Plug in the electrical connectors and fix the wood listel onto the ceiling.*

3.

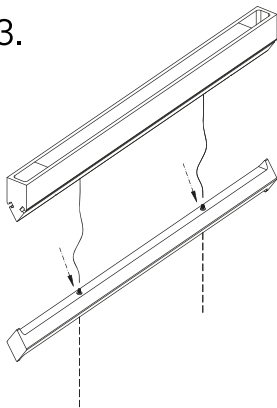

Inserire i cavi d'acciaio tra i vari listelli.

*Insert the steel cables within the wood listels.*

4.

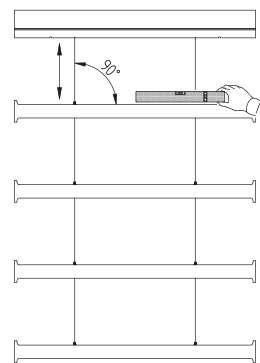

Regolare le distanze tra i profili e disporli perpendicolarmente rispetto ai cavi d'acciaio.

*Adjust the height of the wood listels and place them perpendicularly across the steel cables.*

5.

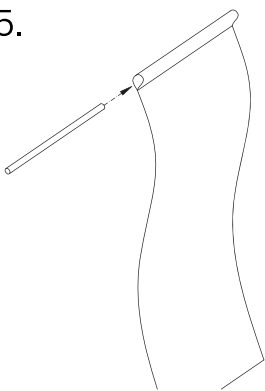

Inserire l'asta nella cucitura della tela.

*Insert the metal rod in the fabric stitching.*

6.

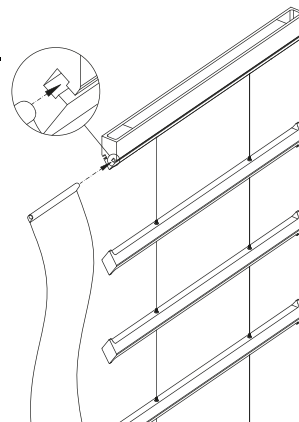

Inserire la tela nell'apposita scanalatura del listello a soffitto.

*Slide the fabric in the track placed on the bottom of the ceiling listel.*

7.

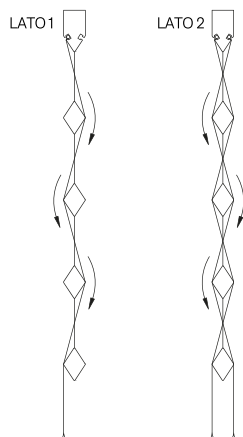

Disporre la tela a listelli alternati.

*Place the fabric so that it alternates between one side and the other.*

8.

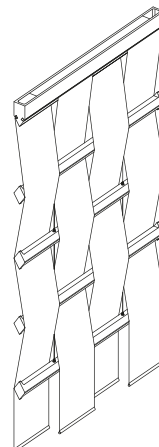

Risultato finale.

*Final result.*

# MULTISPOT

Marc Sadler / Nanne de Ru / Flynn Talbot

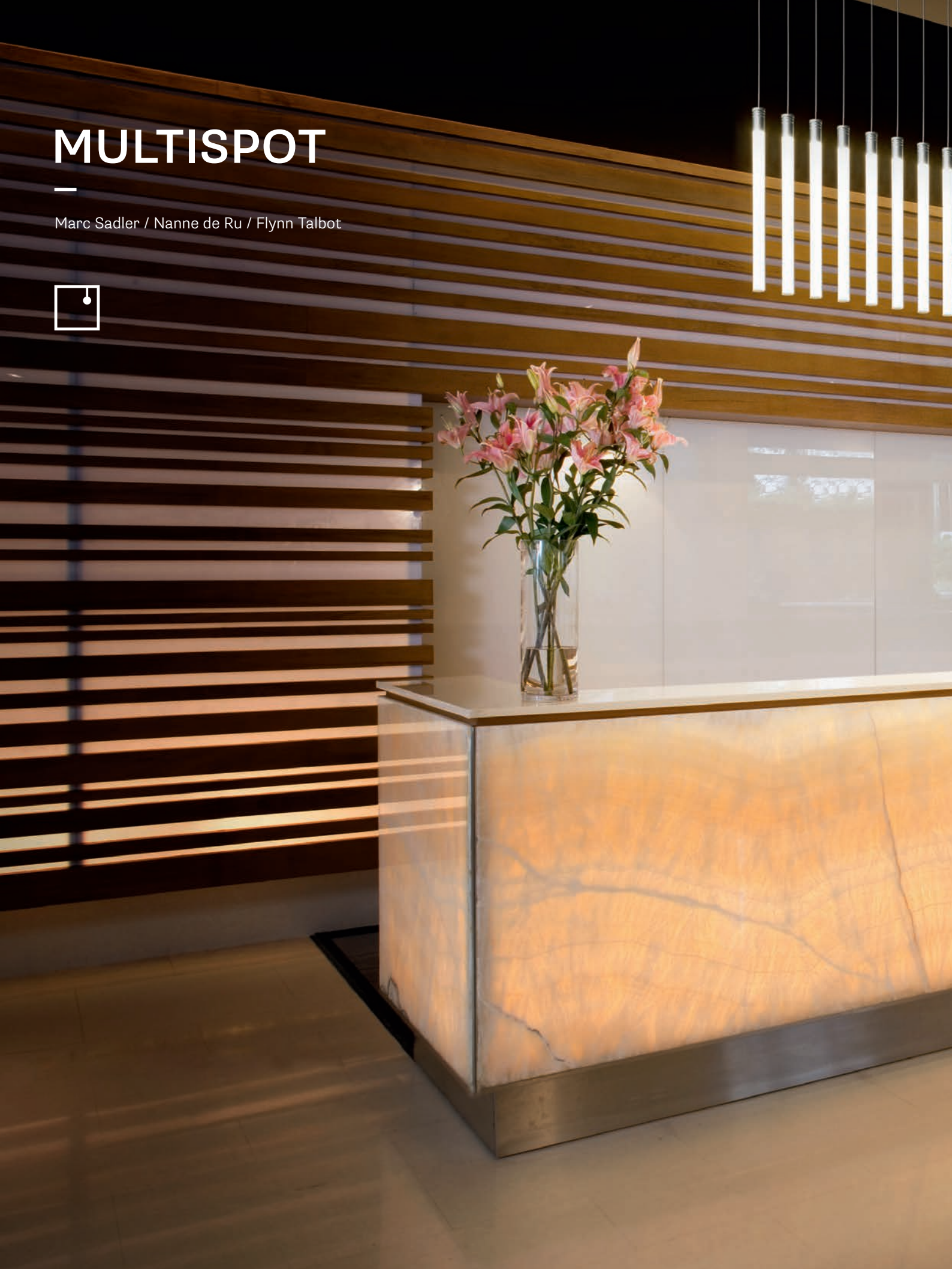







## CONCEPT

---

La continua ricerca dell'esclusività ha portato alla luce una lampada dalla forma personalizzata, unica, preziosa: Multispot. Questo particolare sistema componibile nasce per dare al progettista la possibilità di stabilire le altezze dei diffusori e la posizione dei punti luce adattando quindi la lampada al progetto. Il prodotto si può adattare perfettamente a qualsiasi ambiente grazie anche alla varietà di dimensioni del rosone ed è ideale per impreziosire grandi spazi donando un'atmosfera incantevole e suggestiva. Su richiesta le lampade Multispot sono interamente personalizzabili.

Constant research for exclusive touches has led to the creation of a lamp with a personalised, unique and exquisite shape: Multispot. The particular modular system was designed to give the architect the possibility of establishing the heights at which to position diffusers and lighting points, thus adapting the lamp to any project. The product can be perfectly adapted to suit any environment thanks also to the range of different sizes of ceiling rose available. It is ideal for adding a touch of glamour and charm to large areas. On request, Multispot lamps can be entirely customised.

La búsqueda continua de la exclusividad ha sacado a la luz una lámpara con una forma personalizada, única, preciosa: Multispot. Este sistema modular especial se crea para permitir al proyectista establecer las alturas de los difusores y la posición de los puntos de luz con el fin de adaptar la lámpara al proyecto. El producto se adapta perfectamente a todos los ambientes también por la variedad de dimensiones del rosetón y es ideal para embellecer espacios grandes a los que regala una atmósfera mágica y sugestiva. Las lámparas Multispot son totalmente personalizables bajo pedido.

Die ständige Suche nach Exklusivität hat eine Lampe mit einer individuellen, einzigartigen und wertvollen Form ans Licht gebracht: Multispot. Dieses besondere zusammensetzbare System entstand, um dem Designer die Möglichkeit zu geben, die Höhen der Diffusoren und die Position der Lichtpunkte festzusetzen und somit die Lampe dem Projekt anzupassen. Das Produkt eignet sich perfekt für jede Umgebung, auch dank der verschiedenen Abmessungen der Rosette, und ist ideal, um große Räume aufzuwerten, denen es eine bezaubernde und suggestive Atmosphäre verleiht. Auf Wunsch können die Lampen Multispot ganz individuell gestaltet werden.

La recherche continue de l'exclusivité nous a mené sur une lampe à la forme personnalisée, unique et précieuse: Multispot. Ce système particulier modulable a été créé pour donner à l'architecte la possibilité d'établir les hauteurs des diffuseurs et la position des points de lumière en adaptant donc la lampe au projet. Le produit peut s'adapter parfaitement à tout espace grâce à la variété des dimensions de la rosace et est idéal pour enrichir les grands espaces, tout en offrant une atmosphère charmante et suggestive. Sur demande, les lampes Multispot peuvent être entièrement personnalisées.

Постоянный поиск эксклюзивности в освещении привел к созданию лампы уникальной, значимой формы, которая может видоизменяться под ваши требования: Multispot. Эта необычная композиционная система создана специально, чтобы дать возможность архитектору определять высоту рассеивателей и местоположение точек света, и таким образом модифицировать освещение под требования проекта. Эта подвесная люстра прекрасно смотрится в различных архитектурных решениях, благодаря широкому выбору размеров розетки. Люстра идеально подходит для установки в больших пространствах, которым она придает завораживающую и таинственную атмосферу. Люстры Multispot могут быть произведены специально под индивидуальный заказ.

# MULTISPOT BELUGA

La collezione Beluga si compone di sospensioni per interno ed esterno. I rosoni, di forma e dimensioni diverse, sono in alluminio verniciato a polveri bianchi e possono essere forniti con le forature massime previste, oppure possono essere personalizzati su richiesta. I diffusori di Beluga, forniti in 4 lunghezze di cavo elettrico, sono costituiti da sfere in cristallo trasparente. L'elettrificazione è a tensione di rete per Led.

La colección Beluga está compuesta por lámparas colgantes de interior y exterior. Los rosetones, con formas y tamaños diferentes, son de aluminio pintado con polvos blancos y se pueden suministrar con los orificios máximos previstos o bien se personalizan bajo pedido. Los difusores de Beluga, suministrados con un cable eléctrico en 4 longitudes, están constituidos por esferas de cristal transparente. La electrificación es con tensión de red para Led.

Die Kollektion Beluga besteht aus Hängelampen für Innenbereiche und Aussbereiche. Die Rosetten mit unterschiedlichen Formen und Abmessungen sind aus weiß pulverlackiertem Alu und können mit den vorgesehenen Höchstbohrungen geliefert oder nach Wunsch individuell gestaltet werden. Die Diffusoren von Beluga in 4 Stromkabelängen bestehen aus transparenten Kristallglaskugeln. Die Elektrifizierung erfolgt über Netzspannung bei LED-Lampen.

The Beluga collection is made up of hanging lamps for indoor and outdoor use. The ceiling roses, in different shapes and sizes, are made in white painted aluminium and come either with the standard maximum number of holes, or customised on request. The diffusers of the Beluga series, available in 4 lengths of electrical cable, are composed of transparent lead crystal spheres. The lamp runs on mains power and is suitable for use with LED.

La collection Beluga se compose de suspensions pour intérieur et l'extérieur. Les rosaces, de différentes formes et dimensions sont en aluminium peint en blanc par poudre et peuvent être fournies avec les trous maximums prévus, ou personnalisées sur demande. Les diffuseurs de Beluga, fournis avec 4 longueurs de câble électrique se composent de sphères en cristal transparent. Les LED sont alimentées par la tension du réseau.

Коллекция Beluga состоит из подвесок для внутренних помещений и внешней. Розетки разных форм и размеров из алюминия с белой порошковой окраской могут поставляться с максимально широкими отверстиями, или могут производиться под ваш индивидуальный заказ. Рассеиватели люстры Beluga имеют электрический шнур 4-х разных длин, состоят из сфер из прозрачного кристалла. Электрическая часть рассчитана на светодиодные лампы от сети напряжения.









# MULTISPOT TOOBY

La collezione Tooby si compone di sospensioni per interno ed esterno. I rosoni, di forma e dimensioni diverse, sono in alluminio verniciato a polveri bianchi e possono essere forniti con le forature massime previste, oppure possono essere personalizzati su richiesta. I diffusori di Tooby, forniti in 4 lunghezze di cavo elettrico, sono costituiti da elementi cilindrici in vetro borosilicato (Pyrex®) e tappo in finitura anodizzata e ramata lucida, con all'interno un elemento cilindrico plastico rigato per diffondere la luce omogeneamente lungo tutto il tubo. L'elettrificazione è a tensione di rete per Led.

La colección Tooby está compuesta por lámparas colgantes de interior y exterior. Los rosetones, con formas y tamaños diferentes, son de aluminio pintado con polvos blancos y se pueden suministrar con los orificios máximos previstos o bien se personalizan bajo pedido. Los difusores de Tooby, suministrados con un cable eléctrico en 4 longitudes, están constituidos por elementos cilíndricos de vidrio borosilicato (Pyrex®) y tapón con acabado anodizado y cobrizo brillante, con en el interior un elemento cilíndrico de plástico rayado para difundir la luz uniformemente a lo largo de todo el tubo. La electrificación es con tensión de red para Led.

Die Kollektion Tooby besteht aus Hängelampen für Innenbereiche und Aussbereiche. Die Rosetten mit unterschiedlichen Formen und Abmessungen sind aus weiß pulverlackiertem Alu und können mit den vorgesehenen Höchstbohrungen geliefert oder nach Wunsch individuell gestaltet werden. Die Diffusoren von Tooby in 4 Stromkabelängen bestehen aus zylindrischen Elementen aus Borosilikatglas (Pyrex®) und einem eloxierten kupferpolierten Verschluss mit einem gerillten inneren Kunststoffzylinder, um das Licht gleichmäßig entlang des ganzen Rohrs zu verteilen. Die Elektrifizierung erfolgt über Netzspannung bei LED-Lampen.

The Tooby collection is made up of hanging lamps for indoor and outdoor use. The ceiling roses, in different shapes and sizes, are made in white painted aluminium and come either with the standard maximum number of holes, or customised on request. The diffusers of the Tooby series, available in 4 lengths of electrical cable, are composed of cylindrical elements in borosilicate glass (Pyrex®) and a cap with an anodised and shiny copper finish, with a ribbed plastic cylindrical element inside to diffuse the light evenly along the entire tube. The lamp runs on mains power and is suitable for use with LED.

La collection Tooby se compose de suspensions pour l'intérieur et l'extérieur. Les rosaces, de différentes formes et dimensions, sont en aluminium peint en blanc par poudre et peuvent être fournies avec les trous prévus au maximum ou personnalisées sur demande. Les diffuseurs de Tooby, fournis avec 4 longueurs de câble électrique, sont constitués par des éléments en verre borosilicate (Pyrex®) et par une couverture finition anodisée cuivre brillant, avec un élément cylindrique en plastique rayé à l'intérieur pour une lumière homogène le long du tube. Les LED sont alimentées par la tension du réseau.

Коллекция Тоуби состоит из подвесок для внутренних помещений и внешний. Розетки разных форм и размеров из алюминия с белой порошковой окраской могут поставляться с максимально широкими отверстиями, или могут производиться под ваш индивидуальный заказ. Рассеиватели люстры Тоуби имеют электрический шнур 4-х разных длин, состоят из цилиндрических элементов из боросиликатного стекла (Pyrex®) и колпачка с анодированной и глянцевой медной отделкой; внутри имеется пластиковый цилиндр в полосу для однородного рассеивания света по всей длине лампы. Электрическая часть рассчитана на светодиодные лампы от сети напряжения.











# MULTISPOT POLAIR

La collezione Polair si compone di sospensioni per interno ed esterno. I rosoni, di forma e dimensioni diverse, sono in alluminio verniciato a polveri bianchi e possono essere forniti con le forature massime previste, oppure possono essere personalizzati su richiesta. I diffusori di Polair, forniti in 4 lunghezze di cavo elettrico, sono costituiti da elementi conici in vetro borosilicato (Pyrex®) sabbiato sul fondo e tappo in finitura verniciata nera opaca e ramata lucida. L'elettrificazione è a tensione di rete per LED.

La colección Polair está compuesta por lámparas colgantes de interior y exterior. Los rosetones, con formas y tamaños diferentes, son de aluminio pintado con polvos blancos y se pueden suministrar con los orificios máximos previstos o bien se personalizan bajo pedido. Los difusores de Polair, suministrados con un cable eléctrico en 4 medidas de largo, están constituidos por elementos cónicos de vidrio borosilicato (Pyrex®) arenado en el fondo y tapón con acabado pintado negro mate y cobrizo brillante. La electrificación es con tensión de red para Led.

Die Kollektion Polair besteht aus Hängelampen für Innenbereiche und Aussbereiche. Die Rosetten mit unterschiedlichen Formen und Abmessungen sind aus weiß pulverlackiertem Alu und können mit den vorgesehenen Höchstbohrungen geliefert oder nach Wunsch individuell gestaltet werden. Die Diffusoren von Polair, die in 4 Stromkabelängen geliefert werden, bestehen aus kegelförmigen Elementen aus Borsilicatglas (Pyrex®), die am Boden sandgestrahlt sind und einem mattschwarz und kupferpolierten Verschluss. Die Elektrifizierung erfolgt über Netzspannung bei LED-Lampen.

The Polair collection is made up of hanging lamps for indoor and outdoor use. The ceiling roses, in different shapes and sizes, are made in white painted aluminium and come either with the standard maximum number of holes, or customised on request. The Polair diffusers come in 4 electric cable lengths, and are composed of borosilicate (Pyrex®) glass cylindrical elements, with a sandblasted base, and have a cap with an opaque black and shiny copper finish. The lamp runs on mains power and is suitable for use with LED.

La collection Polair se compose de suspensions pour l'intérieur et l'extérieur. Les rosaces, de forme et de dimensions différentes, sont en aluminium peint par poudre blanche et peuvent être fournies avec les trous maximums prévus. Elles peuvent également être personnalisées. Les diffuseurs de Polair, proposés dans 4 longueurs de fil électrique différentes, se composent d'éléments coniques en verre de borosilicate (Pyrex®) sablé sur le fond et d'une couverture de finition peinte en noir opaque ou cuivre brillant. Les LED sont alimentées par la tension du réseau.

Линейка Polair представляет подвесные светильники для внутреннего освещения помещений и внешний. Розетки, выполненные из алюминия с белым порошковым покрытием, поражают богатством своих форм и размеров. Розетки могут поставляться с максимальным количеством отверстий или же изготавливаться по индивидуальному заказу. Световые рассеиватели Polair оборудованы кабелем разной длины (4 размера) и включают в себя конические элементы из боросиликатного стекла (Pyrex®) с пескоструйной обработкой внутри и колпачок с матовой черной и глянцевой медной отделкой. Электрическая часть рассчитана на светодиодные лампы от сети напряжения.









# MY MULTISPOT

Componi e personalizza la tua lampada Multispot  
/ *Compose and customize your Multispot lamp*

## 1. Scelta dei vetri / *Glass options*

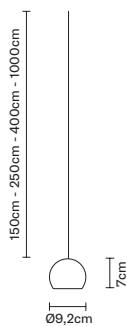

### BELUGA

LED 700mA 3W WHITE 3000K 230lm Cri>80

Dimmerabile / *Dimmable*

**F32L0600** 150cm cavo / cable  
**F32L0700** 250cm cavo / cable  
**F32L0800** 400cm cavo / cable

**ERL** IP55

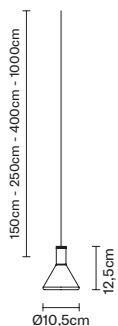

### POLAIR

LED 700mA 2,1W WHITE 2700K 200lm Cri>80

Dimmerabile / *Dimmable*

Struttura in alluminio anodizzato nero  
/ *Black anodized aluminium structure*

**F32L1100** 150cm cavo / cable  
**F32L1200** 250cm cavo / cable  
**F32L1300** 400cm cavo / cable

Struttura in alluminio ramato lucido  
/ *Copper-plated aluminium structure*

**F32L6100** 150cm cavo / cable  
**F32L6200** 250cm cavo / cable  
**F32L6300** 400cm cavo / cable

**ERL** IP55

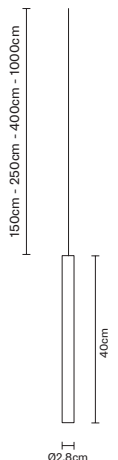

### TOOBY

LED 700mA 2,1W WHITE 2700K 200lm Cri>80

Dimmerabile / *Dimmable*

Struttura in alluminio anodizzato  
/ *Anodized aluminium structure*

**F32L0100** 150cm cavo / cable  
**F32L0200** 250cm cavo / cable  
**F32L0300** 400cm cavo / cable

Struttura in alluminio ramato lucido  
/ *Copper-plated aluminium structure*

**F32L5100** 150cm cavo / cable  
**F32L5200** 250cm cavo / cable  
**F32L5300** 400cm cavo / cable

**ERL** IP55

## 2. Scelta dei rosoni / *Canopies options*

### Rosoni circolari / *Round canopies*

Alimentatore dimmerabile incluso / *Dimmable driver included*

**F32M0101** Ø13x6,6cm - 700mA (1 spot) - Dim. push button 1..10V  
**F32M0301** Ø24x6,6cm - 700mA (5 spots) - Dim. push button 1..10V  
**F32M0501** Ø31x6,6cm - 700mA (10 spots) - Dim. push button 1..10V, DALI  
**F32M0701** Ø39x6,6cm - 700mA (20 spots) - Dim. push button 1..10V, DALI  
**F32M0901** Ø49x6,6cm - 700mA (30 spots) - Dim. push button 1..10V, DALI

**ERL** IP40

### Rosoni rettangolari e quadrati / *Rectangular and square canopies*

Alimentatore dimmerabile incluso / *Dimmable driver included*

**F32M2101** 13x13x6,6cm - 700mA (1 spot) - Dim. push button 1..10V  
**F32M2301** 30x15x6,6cm - 700mA (5 spots) - Dim. push button 1..10V  
**F32M2501** 60x15x6,6cm - 700mA (10 spots) - Dim. push button 1..10V, DALI  
**F32M2701** 90x15x6,6cm - 700mA (20 spots) - Dim. push button 1..10V, DALI  
**F32M2901** 90x15x6,6cm - 700mA (30 spots) - Dim. push button 1..10V, DALI  
**F32M4101** 59,5x59,5x6,6cm - 700mA (30spots) - Dim. push button 1..10V, DALI

**ERL** IP40

### Rosone a incasso / *Recessed canopy*

Alimentatore remoto escluso / *Remote power supply not included*

**F32Z1001** Ø 3cm - (1 spot)

**ERL** IP40

### Box per esterno / *Outdoor box*

Alimentatore incluso / *Driver included*

**F32Z11** 24x19x9cm - (max 10 spot)

**ERL** IP55



Dimensioni e forature del rosone disponibili\*  
/ Canopy dimensions and holes available\*

1 spot  
**F32M0101**

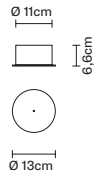

3-5 spots  
**F32M0301**

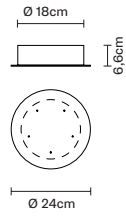

6-10 spots  
**F32M0501**

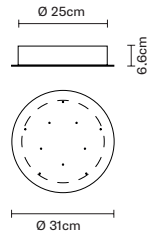

11-20 spots  
**F32M0701**

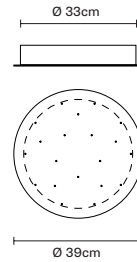

21-30 spots  
**F32M0901**

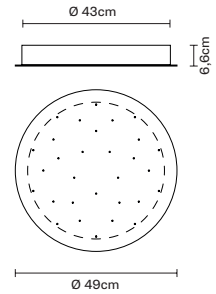

1 spot  
**F32M2101**

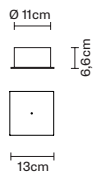

3-5 spots  
**F32M2301**

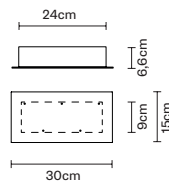

6-10 spots  
**F32M2501**

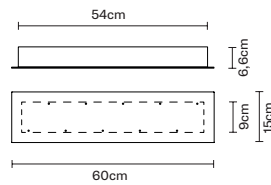

11-20 spots  
**F32M2701**

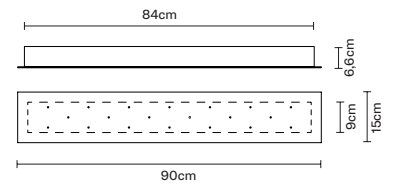

21-30 spots  
**F32M2901**

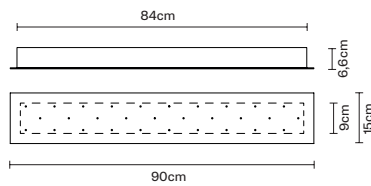

21-30 spots  
**F32M4101**

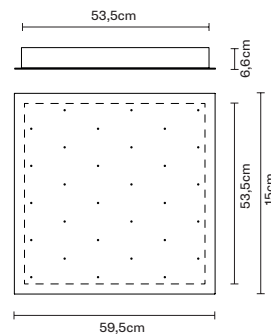

1 spot  
**F32Z1001**

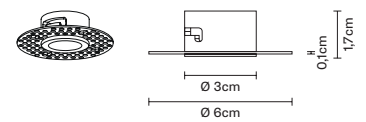

max 10 spots  
**F32Z11**

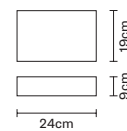

\* Altri tipi di dimmerazione su richiesta. Possibilità di personalizzare le forature.  
\* Other kind of dimming by request. Possibility to customize the holes.



# ROSONE A INCASSO / RECESSED CANOPY

1.

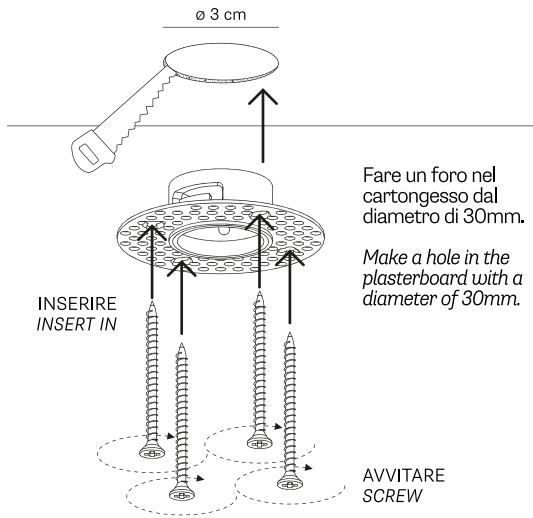

2.

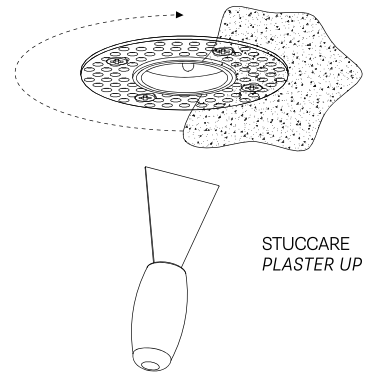

Dopo aver inserito l'accessorio all'interno del foro nel cartongesso, stuccare i bordi.

*After inserting the accessory into the hole in the plasterboard, plaster the edges.*

3.

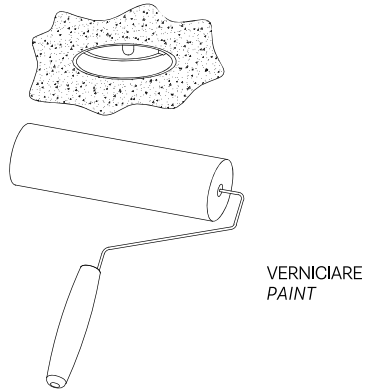

Verniciare l'intera area stuccata in modo da uniformare la finitura del soffitto con l'accessorio.

*Paint the plastered area so that the ceiling finish is homogeneous.*

4.

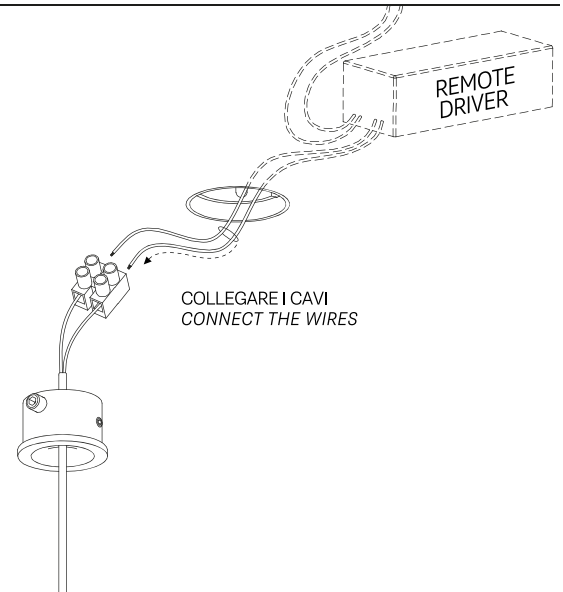

5.

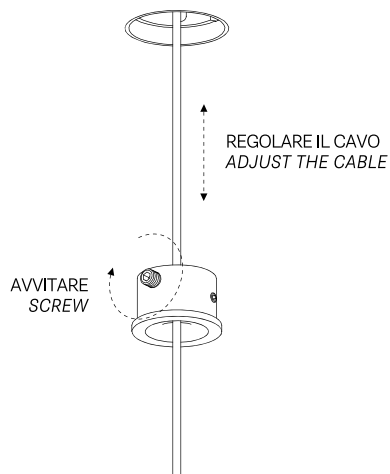

Regolare la lunghezza del cavo e avvitare il grano di plastica.  
*Adjust the length of the cable and screw the plastic thread insert.*

6.

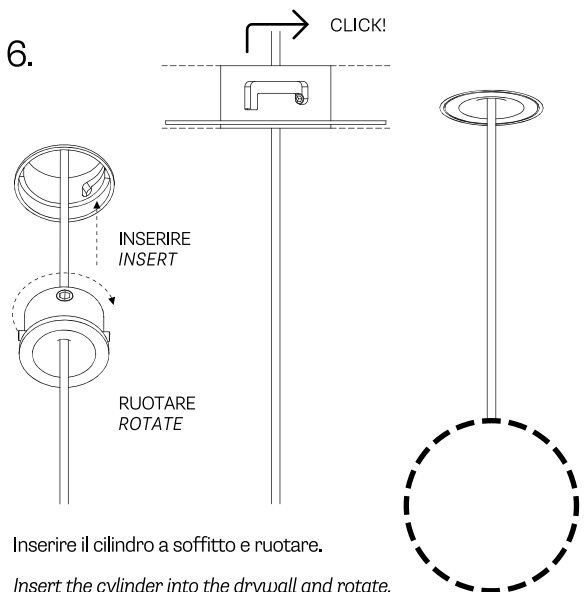

Inserire il cilindro a soffitto e ruotare.  
*Insert the cylinder into the drywall and rotate.*

# TILE

—

Pamio Design

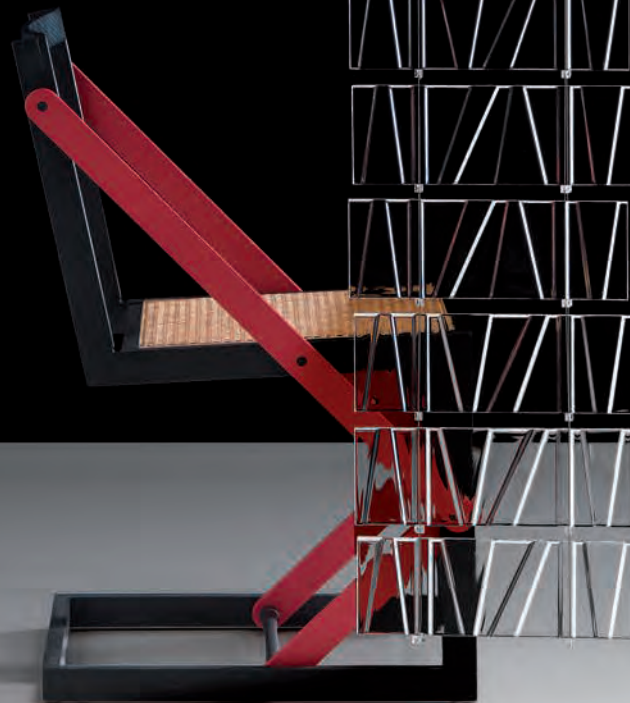

# CONCEPT

---

**Tile nasce dall'idea di Studio Pamio di creare una lampada, una parete luminosa, uno spazio, partendo dal singolo modulo in vetro. La natura come origine del progetto, orizzonti infiniti, moduli singoli o aggregati che aspirano a diventare paesaggi. Pone le sue radici nello spazio naturale, organico, che suggerisce molteplici aggregazioni. Una lampada modulare leggera, trasparente, mutante, libera da comporre. La formella in vetro diventa quindi un modulo per creare o dividere uno spazio pubblico o privato, consentendo la personalizzazione totale di soluzioni compositive.**

Tile was based on an idea of Studio Pamio to create a lamp, a luminous wall and a space starting with a single glass module. The project is inspired by nature, infinite horizons and is made up of individual modules or groups of modules which create landscapes. It is based on natural, organic space that allows for many different layouts. A modular, lightweight lamp which is transparent, constantly changing and can be composed freely. The glass tiles are thus modules that can be used to create or divide public and private spaces, allowing fully personalised layouts.

Tile es concebida en el Studio Pamio para crear una lámpara, una pared luminosa, un espacio a partir de un módulo individual de vidrio. La naturaleza como origen del proyecto, horizontes infinitos, módulos individuales o agregados, que aspiran a convertirse en paisajes. Se radica en el espacio natural, orgánico, que sugiere múltiples agregaciones. Una lámpara modular ligera, transparente, mutante y libre en su composición. La plancha de vidrio se convierte, por consiguiente, en un módulo para crear o separar un espacio público o privado, para permitir la personalización total de soluciones de composición.

Tile entstand aus der Idee des Studio Pamio, eine Lampe, eine Leuchtwand, einen Bereich zu kreieren, der aus einem einzelnen Glasmodul hervorgeht. Die Natur als Ursprung des Projekts, unendliche Horizonte, einzelne oder zusammengesetzte Module, die zu Landschaften werden wollen. Die Ursprünge im natürlichen, organischen Raum, der zahlreiche Kombinationen suggeriert. Eine leichte modulare Lampe, transparent, sich wandelnd, frei zu komponieren. Die Glasform wird zu einem Modul, um einen öffentlichen oder privaten Raum zu kreieren, um eine totale Personalisierung der zusammengesetzten Lösungen zu ermöglichen.

Tile a été conçue par le Studio Pamio pour créer une lampe, une paroi lumineuse, un espace, en partant du simple module en verre. La nature est à l'origine du projet, des horizons infinis, des modules simples ou associés qui aspirent à devenir des paysages. Elle prend ses racines dans l'espace naturel et organique qui suggère une multitude d'associations. Une lampe modulaire légère, transparente, mutante, à composer librement. Le carreau en verre devient donc un module qui crée ou divise un espace public ou privé, tout en permettant de le personnaliser totalement avec des solutions de composition.

Освещение Tile было разработано дизайн-студией Studio Pamio как светильник, светящаяся стена, пространство, которое начинается со стеклянного модуля. Природа как основа проекта, бесконечные горизонты, отдельные модули или композиции из них, которые превращаются в пейзажи, чьи корни уходят в пространство природы, предлагая множество композиций. Стеклянная пластина является модулем, разделяющим помещения в домашнем интерьере или в общественных местах, и позволяют составлять собственные композиции из модулей.

# TILE

---

La collezione si costituisce di strutture componibili in metallo da soffitto e parete per interno. Le soluzioni compositive sono illimitate e personalizzabili, a due o un velo elettrificato o ad un velo non elettrificato. Le barre modulari sono disponibili con rivestimenti in alluminio brillantato e alluminio dorato, gli elementi in vetro cristallino stampato sono disponibili trasparenti, color ambra, acquamarina, verde e ametista. Le singole formelle sono sorrette da cavi in acciaio inox. L'elettrificazione è a tensione di rete per lampade alogene e per LED.

La colección está compuesta por estructuras modulares de metal para techos y paredes para interior. Las soluciones de composición son ilimitadas y personalizables, con dos cortinas de vidrio o una electrificada o con una cortina de vidrio no electrificada. Las barras modulares están disponibles con revestimiento de aluminio abrillantado y aluminio dorado, los elementos de vidrio cristallino moldeado son transparentes, de color ámbar, agua marina, verde y amatista. Cables de acero inoxidable soportan las planchas individuales. La electrificación es con tensión de red para bombillas halógenas y para LED.

Die Kollektion besteht aus zusammensetzbaren Strukturen aus Metall für die Wand- und Deckenausführung für Innenbereiche. Die zusammensetzbare Lösungen sind unbegrenzt und individuell gestaltbar, mit zwei oder einer elektrifizierten Glaswand oder einer nicht elektrifizierten Glaswand. Die modularen Stangen sind mit Glanzalu- und Goldalubeschichtung erhältlich; die gedruckten Kristallglaselemente dagegen transparent, bernsteinfarben, Acqua Marina, Grün und Amethyst. Die einzelnen Formen werden von Edelstahlkabeln gehalten. Die Elektrifizierung erfolgt über Netzspannung bei Halogen- und LED-Lampen.

The collection is made up of modular ceiling and wall structures for indoor use. The possible layouts are endless and can be personalised and may consist of one or two electrically powered "veils", or just one "veil" without electrical power. The modular bars are available in either polished aluminium or gilded aluminium, while the elements in moulded crystalline glass can be transparent or with a tinge of amber, aquamarine, green or amethyst. The individual tiles are supported by stainless steel wires. The lamp runs on mains power and is suitable for use with halogen bulbs and LED.

La collection est constituée par des structures modulables en métal pour plafond et parois pour intérieur. Les solutions de compositions sont illimitées et personnalisables, à deux ou un voile électrifié ou à un voile non électrifié. Les barres modulaires sont disponibles avec des revêtements en aluminium brillant et en aluminium doré, les éléments en verre cristallin moulé sont disponibles transparents, couleur ambre, aigue-marine, vert et améthyste. Tous les carreaux sont soutenus par des câbles en acier inox. Les lampes halogènes et les LED sont alimentées par la tension de réseau.

Коллекция состоит из композиционных осветительных металлических структур для крепления к потолку или к стене. Неограниченные возможности композиции и уникального монтажа, возможность выбрать между одинарной или двойной завесой из электрифицированных пластин или одинарной завесой из неэлектрифицированных пластин. Подвески из блестящего хромированного и позолоченного металла, стеклянные пластины прозрачного, янтарного, аквамаринного, зеленого и аметистового цвета. Пластины держатся на тросах из нержавеющей стали. Электрическая часть рассчитана на галогеновые и светодиодные лампы от сетевого напряжения.

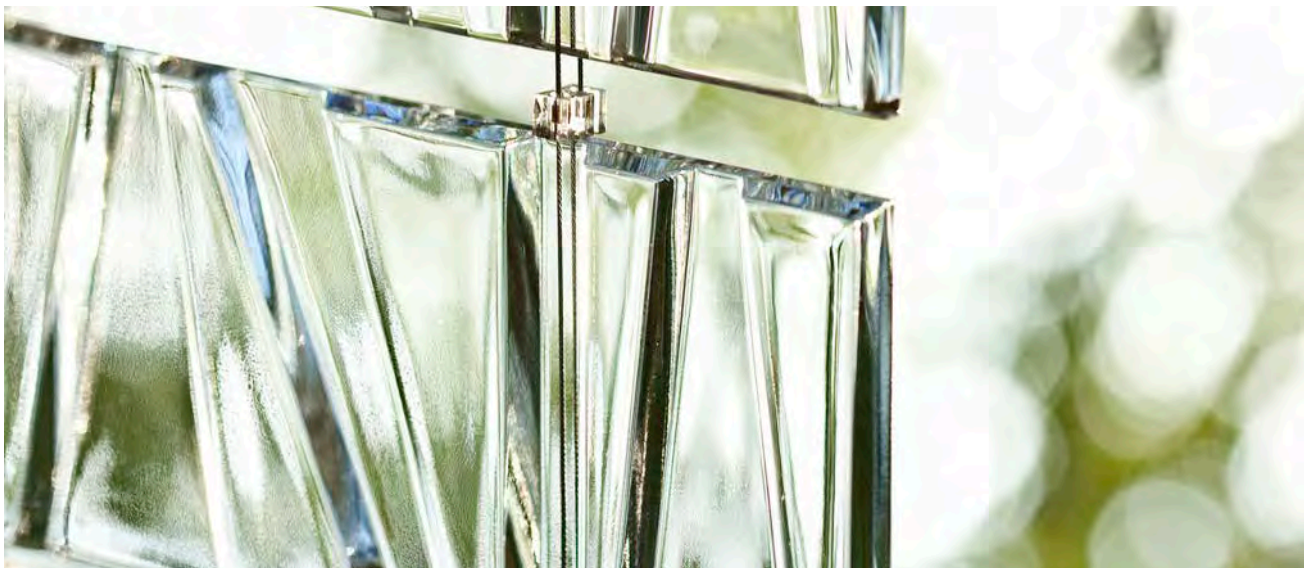









# TILE

Sorgente: GU10 / *Light source: GU10*

Configurazione: 1 o 2 pareti / *Layout: 1 or 2 glass walls*

## 1. Scelta barra e angoli / *Metal bar and angle option*

### 1a. Barre lineari / *Linear bars*

Lunghezza minima: 30 cm  
Modularità ogni 30 cm  
Elettrificazione ogni 30 cm (2x50W GU10)  
Su richiesta sono disponibili elettrificazioni diverse.  
Ogni sistema deve prevedere l'utilizzo di un modulo da 30 cm di partenza.  
I moduli starter sono moduli cablati per l'alimentazione di partenza.

*Minimum length: 30 cm  
30 cm modularity  
Electrification every 30 cm (2x50W GU10)  
Different electrification are available on request.  
Each system has to use a 30 cm starter module.  
The starter modules are electrified.*

**D95M1163** 30 cm (Starter)  
**D95M1263** 30 cm (Modulo / *Module*)  
**D95M1363** 60 cm (Modulo / *Module*)  
**D95M1463** 90 cm (Modulo / *Module*)  
**D95M1563** 120 cm (Modulo / *Module*)

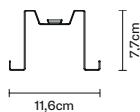
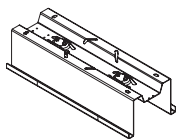

### 1b. Coppia di tappi / *Couple of caps*

Alluminio brillantato / *Polished aluminium*  
**D95Z2015**

Alluminio dorato / *Golden aluminium*  
**D95Z2012**

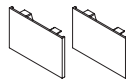

### 1c. Kit parete / *Wall kit*

Lunghezza minima: 30 cm  
Modularità ogni 30 cm  
Per la versione a parete vanno aggiunte alle barre lineari indicate qui a lato (D95M1...) uno dei seguenti kit in base alla lunghezza desiderata.

*Minimum length: 30 cm  
30 cm modularity  
For the wall version, it must be added to the linear bars indicated at right (D95M1...) one of the following kits according to the desired length.*

**D95Z0263** 30 cm  
**D95Z0363** 60 cm  
**D95Z0463** 90 cm  
**D95Z0563** 120 cm

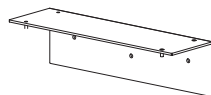

### 1d. Barra ad angolo / *Angle bar*

**D95M1663** 30x30 cm (Starter)

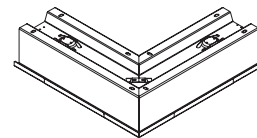

### 1d. Barra quadrata / *Square bar*

**D95M1763** 30x30 cm (Starter)

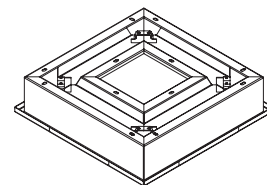

## 2. Scelta fasce di rivestimento / Cover options

Alluminio brillantato / Polished aluminium

**D95Z1027** 30 cm  
**D95Z1127** 60 cm  
**D95Z1227** 90 cm  
**D95Z1327** 120 cm  
**D95Z1427** 150 cm  
**D95Z1527** 180 cm  
**D95Z1627** 19,1 cm

Alluminio dorato / Golden aluminium

**D95Z1074** 30 cm  
**D95Z1174** 60 cm  
**D95Z1274** 90 cm  
**D95Z1374** 120 cm  
**D95Z1474** 150 cm  
**D95Z1574** 180 cm  
**D95Z1674** 19,1 cm

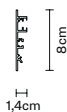

## 3. Scelta vetri / Glass options



**D95E01C4V00**  
29x11 cm



**D95E01C4V05**  
29x11 cm

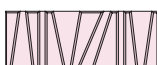

**D95E01C4V40**  
29x11 cm



**D95E01C4V43**  
29x11 cm



**D95E01C4V47**  
29x11 cm



**D95E02C4V00**  
19x11 cm

## 4. Cavi di sostegno / Support cable

I cavi di sostegno (D95Z49) verranno consegnati in base alla disposizione compositiva, della quale devono essere indicate il numero di vetri e il numero degli spazi vuoti interni alla composizione.

*The support cables (D95Z49) delivery is based on the building option preferred, of which the number of glasses and interior empty spaces has to be specified.*

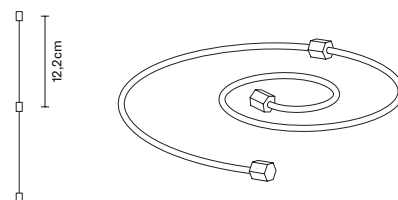

## 5. Ferma cavi di sicurezza / Security cable fastener

Nel caso in cui si raggiunga un'altezza superiore a 200 cm dovrà essere ordinato necessariamente il ferma cavo di sicurezza (D95Z48C08), nella misura di 1 per ogni cavo d'acciaio.

*In case the composition length were higher than cm 200 one security cable fastener (D95Z48C08) for each stainless steel cable has to be ordered.*



# TILE

Sorgente: LED BAR / *Light source: LED BAR*

Configurazione: 1 o 2 pareti / *Layout: 1 or 2 glass walls*

## 1. Scelta barra e angoli / *Metal bar and angle option*

### 1a. Barre lineari / *Linear bars*

Lunghezza minima: 30 cm  
Modularità ogni 30 cm  
Ogni barra è compresa di 4 ferma cavo di sicurezza.  
Ogni alimentatore è dimmerabile e supporta max 12 barre LED.

*Minimum length: 30 cm  
30 cm modularity  
4 security cable fasteners are included in each bar.  
Each driver is dimmable and supports max 12 LED bar.*

**D95M0163** 30 cm  
(Starter, Alim. non incluso / Alim. not included)

**D95M0263** 30 cm  
(Starter, 1 Alim. dim. incluso / 1 Alim. dim. included)

**D95M0363** 30 cm  
(Starter, 2 Alim. dim. incluso / 2 Alim. dim. included)

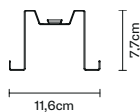
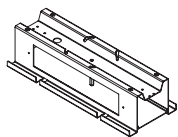

### 1b. Coppia di tappi / *Couple of caps*

Alluminio brillantato / *Polished aluminium*  
**D95Z2015**

Alluminio dorato / *Golden aluminium*  
**D95Z2012**

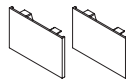

### 1c. Kit parete / *Wall kit*

Lunghezza minima: 30 cm  
Modularità ogni 30 cm  
Per la versione a parete vanno aggiunte alle barre lineari indicate qui a lato (D95MO...) il seguente kit in base alla lunghezza desiderata.

*Minimum length: 30 cm  
30 cm modularity  
For the wall version, it must be added to the linear bars indicated at right (D95MO...) the following kit according to the desired length.*

**D95Z0263** 30 cm  
**D95Z0363** 60 cm  
**D95Z0463** 90 cm  
**D95Z0563** 120 cm

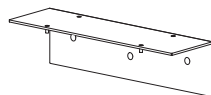

### 1d. Barra ad angolo / *Angle bar*

Ogni alimentatore è dimmerabile e supporta max 12 barre LED.  
*Each driver is dimmable and supports max 12 LED bar.*

**D95M0663** 30x30 cm  
(Starter, 2 Alim. dim. incluso / 2 Alim. dim. included)

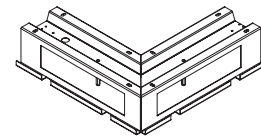

### 1d. Barra quadrata / *Square bar*

Ogni alimentatore è dimmerabile e supporta max 12 barre LED.  
*Each driver is dimmable and supports max 12 LED bar.*

**D95M0763** 30x30 cm  
(Starter, 4 Alim. dim. incluso / 4 Alim. dim. included)

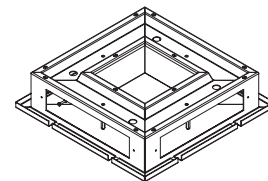

## 2. Scelta fasce di rivestimento / Cover options

Alluminio brillantato / Polished aluminium

**D95Z1027** 30 cm  
**D95Z1127** 60 cm  
**D95Z1227** 90 cm  
**D95Z1327** 120 cm  
**D95Z1427** 150 cm  
**D95Z1527** 180 cm  
**D95Z1627** 19,1 cm

Alluminio dorato / Golden aluminium

**D95Z1074** 30 cm  
**D95Z1174** 60 cm  
**D95Z1274** 90 cm  
**D95Z1374** 120 cm  
**D95Z1474** 150 cm  
**D95Z1574** 180 cm  
**D95Z1674** 19,1 cm

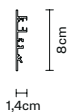

## 3. Scelta vetri / Glass options



**D95E01C4V00**  
29x11 cm



**D95E01C4V05**  
29x11 cm

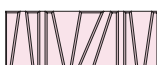

**D95E01C4V40**  
29x11 cm



**D95E01C4V43**  
29x11 cm



**D95E01C4V47**  
29x11 cm



**D95E02C4V00**  
19x11 cm

## 4. Cavi di sostegno / Support cable

I cavi di sostegno (D95Z49) verranno consegnati in base alla disposizione compositiva, della quale devono essere indicate il numero di vetri e il numero degli spazi vuoti interni alla composizione.

*The support cables (D95Z49) delivery is based on the building option preferred, of which the number of glasses and interior empty spaces has to be specified.*

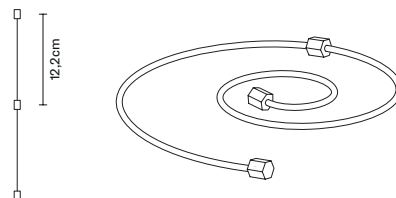

## 5. Sorgente luminosa a LED / LED light source

**D95Z51** 5W 24Vdc 2700K 400lm CRI 80

Ogni alimentatore è dimmerabile 1..10V e supporta max 12 barre LED. Altri tipi di dimmerazione su richiesta.

*Each driver is dimmable 1..10V and supports max 12 LED bar. Other kind of dimming by request.*

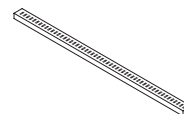

# TILE

Sorgente: LED STRIP / *Light source: LED STRIP*

Configurazione: 1 o 2 pareti / *Layout: 1 or 2 glass walls*

## 1. Scelta barra e angoli / *Metal bar and angle option*

### 1a. Barre lineari / *Linear bars*

Lunghezza minima: 30 cm  
Modularità ogni 30 cm  
LED e driver non inclusi.

*Minimum length: 30 cm  
30 cm modularity  
LED and driver not included.*

**D95M2263** 30 cm  
**D95M2363** 60 cm  
**D95M2463** 90 cm  
**D95M2563** 120 cm

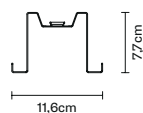
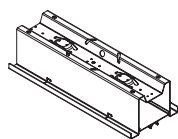

### 1b. Coppia di tappi / *Couple of caps*

Alluminio brillantato / *Polished aluminium*  
**D95Z2015**

Alluminio dorato / *Golden aluminium*  
**D95Z2012**

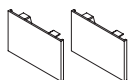

### 1c. Kit parete / *Wall kit*

Lunghezza minima: 30 cm  
Modularità ogni 30 cm  
Per la versione a parete vanno aggiunte alle barre lineari indicate qui a lato (D95M2...) uno dei seguenti kit in base alla lunghezza desiderata.

*Minimum length: 30 cm  
30 cm modularity  
For the wall version, it must be added to the linear bars indicated at right (D95M2...) one of the following kits according to the desired length.*

**D95Z0263** 30 cm  
**D95Z0363** 60 cm  
**D95Z0463** 90 cm  
**D95Z0563** 120 cm

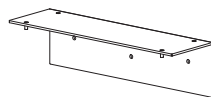

### 1d. Barra ad angolo / *Angle bar*

**D95M2663** 30x30 cm (Starter)

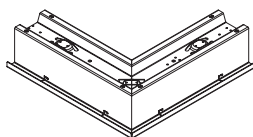

### 1d. Barra quadrata / *Square bar*

**D95M2763** 30x30 cm

LED e driver non inclusi.  
*LED and driver not included.*

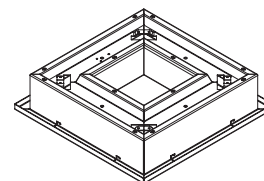

## 2. Scelta fasce di rivestimento / *Cover options*

Alluminio brillantato / *Polished aluminium*

**D95Z1027** 30 cm  
**D95Z1127** 60 cm  
**D95Z1227** 90 cm  
**D95Z1327** 120 cm  
**D95Z1427** 150 cm  
**D95Z1527** 180 cm  
**D95Z1627** 19,1 cm

Alluminio dorato / *Golden aluminium*

**D95Z1074** 30 cm  
**D95Z1174** 60 cm  
**D95Z1274** 90 cm  
**D95Z1374** 120 cm  
**D95Z1474** 150 cm  
**D95Z1574** 180 cm  
**D95Z1674** 19,1 cm

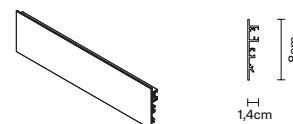

### 3. Scelta vetri / Glass options



**D95E01C4V00**  
29x11 cm



**D95E01C4V05**  
29x11 cm

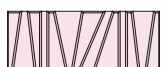

**D95E01C4V40**  
29x11 cm



**D95E01C4V43**  
29x11 cm



**D95E01C4V47**  
29x11 cm



**D95E02C4V00**  
19x11 cm

### 4. Cavi di sostegno / Support cable

I cavi di sostegno (D95Z49) verranno consegnati in base alla disposizione compositiva, della quale devono essere indicate il numero di vetri e il numero degli spazi vuoti interni alla composizione.

*The support cables (D95Z49) delivery is based on the building option preferred, of which the number of glasses and interior empty spaces has to be specified.*

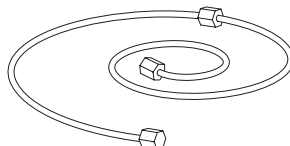
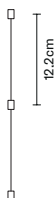

### 6. Sorgente luminosa a LED e lente / LED and lens light source

**D95Z53** LED Strip 24Vdc 3000K Cri 80  
23W 2600 lm al metro / *by meter*  
**D95Z55** LED Lens 30°

Vendute al metro.

Specificare le lunghezze delle singole tratte lineari.

*Sold by meter.*

*Specify the lengths of the single linear section.*

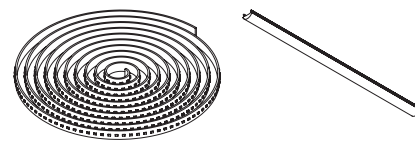

### 5. Ferma cavi di sicurezza / Security cable fastener

Nel caso in cui si raggiunga un'altezza superiore a 200 cm dovrà essere ordinato necessariamente il ferma cavo di sicurezza (D95Z48C08), nella misura di 1 per ogni cavo d'acciaio.

*In case the composition length were higher than cm 200 one security cable fastener (D95Z48C08) for each stainless steel cable has to be ordered.*



### 7. Alimentazione / Power supply

Segliere l'alimentatore a tensione costante adeguato alla misura del tratto lineare:

A50202 20W 24Vdc, dimm. 1..10V (max 30cm)  
A50203 25W 24Vdc, dimm. 1..10V (max 60cm)  
A50204 40W 24Vdc, dimm. 1..10V (max 120cm)  
A50205 60W 24Vdc, dimm. 1..10V (max 210cm)  
A50206 90W 24Vdc, dimm. 1..10V (max 300cm)  
A50308 Kit per controllo Dali (4 canali d'uscita)  
e Push (max 300cm)

*Choose the suitable LED power supply constant voltage according to the length of the structure:*

A50202 20W 24Vdc, dimmable 1..10V (max 30cm)  
A50203 25W 24Vdc, dimmable 1..10V (max 60cm)  
A50204 40W 24Vdc, dimmable 1..10V (max 120cm)  
A50205 60W 24Vdc, dimmable 1..10V (max 210cm)  
A50206 90W 24Vdc, dimmable 1..10V (max 300cm)  
A50308 Dali (4 output channel) and Push kit  
control (max 300cm)

# TILE

Senza sorgente / *No light source*

Configurazione: 1 pareti / *Layout: 1 glass wall*

## 1. Scelta barra e angoli / *Metal bar and angle option*

### 1a. Barre lineari / *Linear bars*

Lunghezza minima: 30 cm  
Modularità ogni 30 cm

*Minimum length: 30 cm  
30 cm modularity*

Alluminio brillantato / *Polished aluminium*

**D95M3263** 30 cm  
**D95M3363** 60 cm  
**D95M3463** 90 cm  
**D95M3563** 120 cm

Alluminio dorato / *Golden aluminium*

**D95M3274** 30 cm  
**D95M3374** 60 cm  
**D95M3474** 90 cm  
**D95M3574** 120 cm

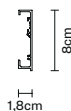
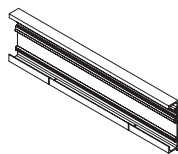

### 1b. Tappi / *Cups*

Alluminio brillantato / *Polished aluminium*

**D95Z2115** Tappo destro / *Right cap*  
**D95Z2215** Tappo sinistro / *Left cap*

Alluminio dorato / *Golden aluminium*

**D95Z2112** Tappo destro / *Right cap*  
**D95Z2212** Tappo sinistro / *Left cap*



## 2. Scelta fasce di rivestimento / *Cover options*

Alluminio brillantato / *Polished aluminium*

**D95Z1027** 30 cm  
**D95Z1127** 60 cm  
**D95Z1227** 90 cm  
**D95Z1327** 120 cm  
**D95Z1427** 150 cm  
**D95Z1527** 180 cm  
**D95Z1627** 19,1 cm

Alluminio dorato / *Golden aluminium*

**D95Z1074** 30 cm  
**D95Z1174** 60 cm  
**D95Z1274** 90 cm  
**D95Z1374** 120 cm  
**D95Z1474** 150 cm  
**D95Z1574** 180 cm  
**D95Z1674** 19,1 cm

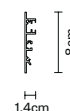
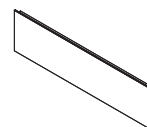



### 3. Scelta vetri / Glass options



**D95E01C4V00**  
29x11 cm



**D95E01C4V05**  
29x11 cm

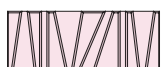

**D95E01C4V40**  
29x11 cm



**D95E01C4V43**  
29x11 cm



**D95E01C4V47**  
29x11 cm



**D95E02C4V00**  
19x11 cm

### 4. Cavi di sostegno / Support cable

I cavi di sostegno (D95Z49) verranno consegnati in base alla disposizione compositiva, della quale devono essere indicate il numero di vetri e il numero degli spazi vuoti interni alla composizione.

*The support cables (D95Z49) delivery is based on the building option preferred, of which the number of glasses and interior empty spaces has to be specified.*

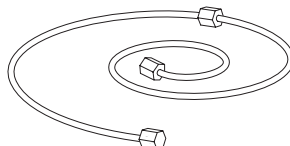
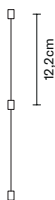

### 5. Ferma cavi di sicurezza / Security cable fastener

Nel caso in cui si raggiunga un'altezza superiore a 200 cm dovrà essere ordinato necessariamente il ferma cavo di sicurezza (D95Z48C08), nella misura di 1 per ogni cavo d'acciaio.

*In case the composition length were higher than cm 200 one security cable fastener (D95Z48C08) for each stainless steel cable has to be ordered.*



# TILE

Sorgente: LED STRIP / *Light source: LED STRIP*

Configurazione: 1 parete / *Layout: 1 glass wall*

## 1. Scelta barra e angoli / *Metal bar and angle option*

### 1a. Barre lineari / *Linear bars*

Lunghezza minima: 30 cm  
Modularità ogni 30 cm  
LED e driver non inclusi.

*Minimum length: 30 cm  
30 cm modularity  
LED and driver not included.*

**D95M4263** 30 cm  
**D95M4363** 60 cm  
**D95M4463** 90 cm  
**D95M4563** 120 cm

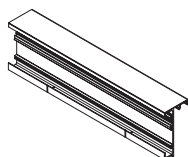

### 1b. Tappi / *Cups*

Alluminio brillantato / *Polished aluminium*  
**D95Z2115** Tappo destro / *Right cap*  
**D95Z2215** Tappo sinistro / *Left cap*

Alluminio dorato / *Golden aluminium*  
**D95Z2112** Tappo destro / *Right cap*  
**D95Z2212** Tappo sinistro / *Left cap*



## 2. Scelta fasce di rivestimento / *Cover options*

Alluminio brillantato / *Polished aluminium*

**D95Z1027** 30 cm  
**D95Z1127** 60 cm  
**D95Z1227** 90 cm  
**D95Z1327** 120 cm  
**D95Z1427** 150 cm  
**D95Z1527** 180 cm  
**D95Z1627** 19,1 cm

Alluminio dorato / *Golden aluminium*

**D95Z1074** 30 cm  
**D95Z1174** 60 cm  
**D95Z1274** 90 cm  
**D95Z1374** 120 cm  
**D95Z1474** 150 cm  
**D95Z1574** 180 cm  
**D95Z1674** 19,1 cm

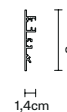
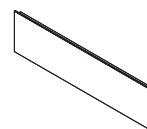

### 3. Scelta vetri / Glass options



**D95E01C4V00**  
29x11 cm



**D95E01C4V05**  
29x11 cm

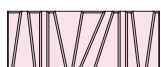

**D95E01C4V40**  
29x11 cm



**D95E01C4V43**  
29x11 cm



**D95E01C4V47**  
29x11 cm



**D95E02C4V00**  
19x11 cm

### 4. Cavi di sostegno / Support cable

I cavi di sostegno (D95Z49) verranno consegnati in base alla disposizione compositiva, della quale devono essere indicate il numero di vetri e il numero degli spazi vuoti interni alla composizione.

*The support cables (D95Z49) delivery is based on the building option preferred, of which the number of glasses and interior empty spaces has to be specified.*

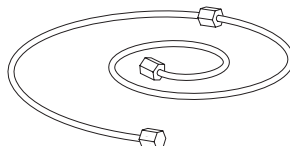
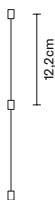

### 6. Sorgente luminosa a LED e lente / LED and lens light source

**D95Z53** LED Strip 24Vdc 3000K Cri 80  
23W 2600 lm al metro / *by meter*  
**D95Z55** LED Lens 30°

Vendute al metro.

Specificare le lunghezze delle singole tratte lineari.

*Sold by meter.*

*Specify the lengths of the single linear section.*

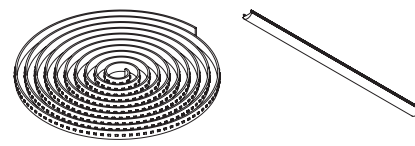

### 5. Ferma cavi di sicurezza / Security cable fastener

Nel caso in cui si raggiunga un'altezza superiore a 200 cm dovrà essere ordinato necessariamente il ferma cavo di sicurezza (D95Z48C08), nella misura di 1 per ogni cavo d'acciaio.

*In case the composition length were higher than cm 200 one security cable fastener (D95Z48C08) for each stainless steel cable has to be ordered.*



### 7. Alimentazione / Power supply

Segliere l'alimentatore a tensione costante adeguato alla misura del tratto lineare:

A50202 20W 24Vdc, dimm. 1..10V (max 30cm)  
A50203 25W 24Vdc, dimm. 1..10V (max 60cm)  
A50204 40W 24Vdc, dimm. 1..10V (max 120cm)  
A50205 60W 24Vdc, dimm. 1..10V (max 210cm)  
A50206 90W 24Vdc, dimm. 1..10V (max 300cm)  
A50308 Kit per controllo Dali (4 canali d'uscita)  
e Push (max 300cm)

*Choose the suitable LED power supply constant voltage according to the length of the structure:*

A50202 20W 24Vdc, dimmable 1..10V (max 30cm)  
A50203 25W 24Vdc, dimmable 1..10V (max 60cm)  
A50204 40W 24Vdc, dimmable 1..10V (max 120cm)  
A50205 60W 24Vdc, dimmable 1..10V (max 210cm)  
A50206 90W 24Vdc, dimmable 1..10V (max 300cm)  
A50308 Dali (4 output channel) and Push kit  
control (max 300cm)



# MONTAGGIO / ASSEMBLY

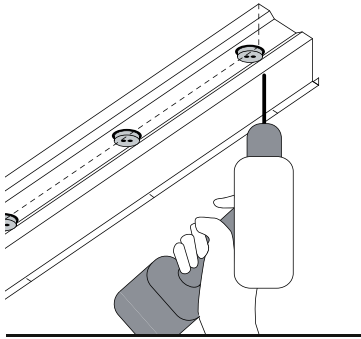

Collegamento elettrico e fissaggio della barra.  
*Electrical connection and bar fastening.*

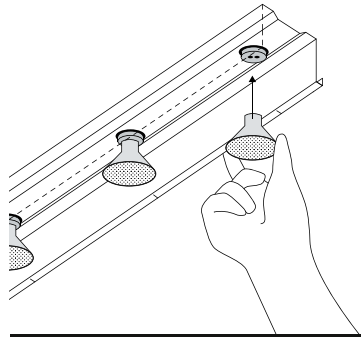

Inserimento delle lampadine.  
*Light bulbs installation.*

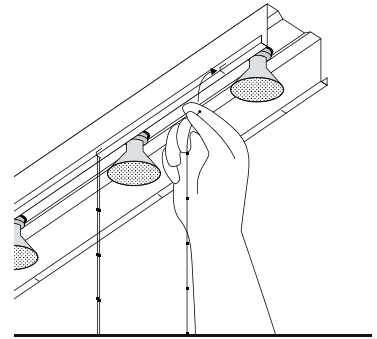

Inserimento dei cavi e loro taglio a misura.  
*Stainless steel cables insertion and cut.*

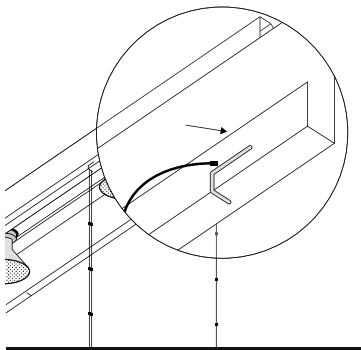

Dettaglio dell'inserimento del cavo.  
*Cable insertion detail.*

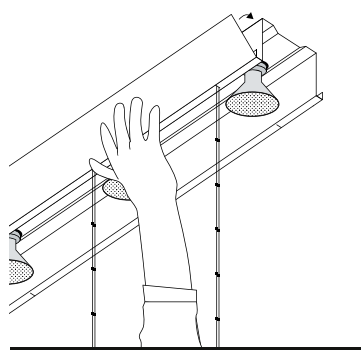

Posizionamento della fascia di rivestimento.  
*Cover assembly.*

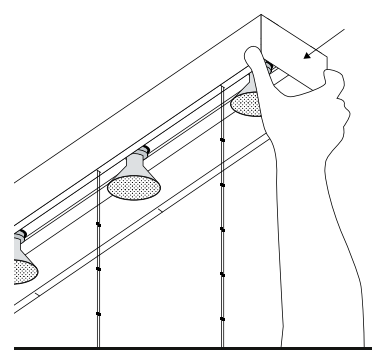

Inserimento dei tappi di chiusura.  
*Locking caps assembly.*

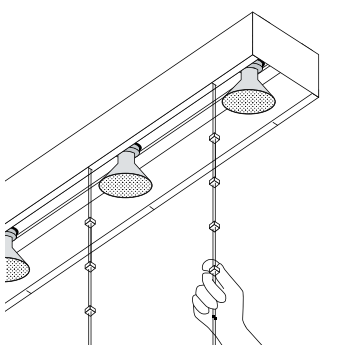

Montaggio dei ferma vetro.  
*Glass fastener assembly.*

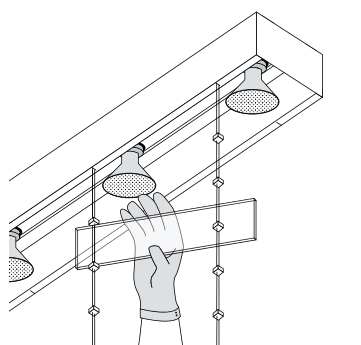

Inserimento degli elementi in vetro cristallino.  
*Glass tiles insertion.*

# TRIPLA

Desall / Devis Busato & Giulia Ciccarese



## CONCEPT

---

I giovani designer Devis Busato e Giulia Ciccarese, vincitori del contest indetto da Fabbian Illuminazione in collaborazione con Desall, hanno dato origine a questa serie di lampade decorative in vetro cristallo.

Tripla nasce dalla forma basica del triangolo e si evolve nell'elemento volumetrico della piramide. La sua forma tetraedrica si propone come completamento alla raccolta Fabbian di lampade dalle forme essenziali. Solida e preziosa, riveste la luce con versatilità, eleganza e modularità, permettendo lo sviluppo di diverse applicazioni e adattandosi a tutti gli ambienti.

The young designers Devis Busato and Giulia Ciccarese, winners of the competition organised by Fabbian Illuminazione in collaboration with Desall, came up with this series of highly decorative lamps in crystal.

The concept behind Tripla is the basic triangle, which evolves, acquiring volume to become a pyramid. Its tetrahedral shape is a fine addition to Fabbian's collections of lamps in essential shapes. Its solid, exquisite design produces a versatile, elegant and modular light for different applications and settings.

Los jóvenes diseñadores Devis Busato y Giulia Ciccarese, ganadores del contest convocado por Fabbian Illuminazione en colaboración con Desall, han creado esta serie de lámparas decorativas de vidrio cristal.

Tripla deriva de la forma básica del triángulo y se desarrolla en el elemento volumétrico de la pirámide. Su forma en tetraedro completa la colección de Fabbian de lámparas con formas esenciales. Sólida y preciosa, viste la luz con versatilidad, elegancia y modularidad para permitir el desarrollo de distintas aplicaciones y adaptarse a todos los ambientes.

Die jungen Designer Devis Busato und Giulia Ciccarese, Sieger des von Fabbian Illuminazione in Zusammenarbeit mit Desall organisierten Contest, haben dieser Dekorationslampenserie aus Kristallglas Leben geschenkt. Tripla entstand aus der Grundform des Dreiecks und entwickelte sich in das volumetrische Element einer Pyramide. Ihre tetraedrische Form präsentiert sich als Vervollständigung der Fabbian-Lampenkollektion mit essentiellen Formen. Solide und wertvoll verbreitet sie das Licht vielseitig, elegant und modular und ermöglicht so die Entwicklung verschiedener Anwendungen, die sich allen Umgebungen anpassen.

Les jeunes designers Devis Busato et Giulia Ciccarese, vainqueurs du concours organisé par Fabbian Illuminazione en collaboration avec Desall, ont donné naissance à cette série de lampes de décoration en verre cristal. Tripla, dont la base est triangulaire se développe grâce à l'élément volumétrique de la pyramide. Sa forme tétraédrique complète la collection de lampes Fabbian dont les formes sont essentielles. Ces lampes sont solides et précieuses, leur lumière est universelle, élégante et modulable. Elles s'adaptent à tout type d'environnement et s'intègrent dans tout type de pièce.

Эта коллекция декоративных ламп из хрустального стекла была создана молодыми дизайнерами Девисом Бузато и Джулией Чиккаресе, победителями конкурса, организованного Fabbian Illuminazione при содействии Desall. Коллекция Tripla основана на базовой форме треугольника, которая эволюционирует в объемный элемент пирамиды. Благодаря своим четырехгранным контурам светильники гармонично дополняют коллекцию ламп геометрических форм Fabbian. Элегантные и практичные светильники, благодаря своей универсальности, утонченности и модульности, гармонично вписываются в интерьеры любого стиля и могут находить самое различное применение, в зависимости от желания и фантазии декоратора.

# TRIPLA

La collezione Tripla è composta da una sospensione, una lampada da tavolo, una lampada da parete, una da soffitto e un incasso in un'unica dimensione ma in tre differenti finiture della struttura: alluminio lucido, grigio antracite e verniciata bronzo. Inoltre è disponibile in sistemi finiti o completamente personalizzabili con struttura delle lampade in tre varianti colore, i rosoni sono disponibili in due dimensioni e nelle tre opzioni di finitura. Tutte le lampade sono per interno. I diffusori sono in vetro cristallo. L'elettrificazione è a tensione di rete per LED con alimentatore dimmerabile integrato.

La colección Tripla está compuesta por una lámpara colgante, una lámpara de sobremesa, un aplique, un plafón y un foco en un solo tamaño pero con tres acabados distintos para la estructura: aluminio brillante, gris antracita y pintada de color bronce. Asimismo existe en sistemas acabados o completamente personalizables con estructura de las lámparas en tres colores distintos; los rosetones existen en dos tamaños y en las tres opciones de acabado. Todas las lámparas son de interior. Los difusores son de vidrio cristal. La electrificación es con tensión de red para Led con un alimentador electrónico integrado con intensidad de la luz regulable.

Die Kollektion Tripla besteht aus einer Hängelampe, einer Tischlampe, einer Wandlampe, einer Deckenlampe und einer Einbaulampe mit einer einzigartigen Abmessung, aber in drei verschiedenen Ausführungen der Struktur: poliertes Alu, anthrazitgrau und bronzelackiert. Außerdem ist sie in Fertigsystemen erhältlich oder ganz individuell gestaltbar, wobei die Struktur der Lampen in drei Farbvarianten angeboten wird; die Rosetten sind in zwei Abmessungen und in drei Ausführungen erhältlich. Alle Lampen sind für Innenbereiche. Die Diffusoren sind aus Kristallglas. Die Elektrifizierung erfolgt über Netzspannung für LED mit integriertem, dimmerbarem Netzteil.

The Tripla collection is made up of one hanging lamp, one table lamp, one wall lamp and one ceiling lamp. It also includes a recessed lighting fixture which is flat yet available in three different finishes: polished aluminium, anthracite grey and a bronze plate. It is also available in modular systems and can also be fully personalised with lamps in three colour variants, while the ceiling roses are available in two sizes and in three different finishes. All the lamps are for indoor use. The diffusers are in crystal. The energy voltage is LED with an incorporated dimmer switch.

La collection Tripla se compose d'une lampe suspension, d'une lampe de table, d'une applique murale, d'un plafonnier et d'une lampe encastrable d'une seule dimension mais dont la structure est possède trois types de finitions différentes : aluminium brillant, gris anthracite et peinture couleur bronze. Cette lampe est par ailleurs disponible sous la forme de systèmes finis ou totalement personnalisable. La structure des lampes est proposée avec trois couleurs différentes, les rosettes sont proposées dans deux dimensions dans les trois finitions de couleurs. Toutes les lampes sont conçues pour l'intérieur. Les diffuseurs sont en verre de cristal. Elles utilisent des ampoules à LED et sont munies d'un variateur de lumière.

Коллекция Tripla включает в себя подвесной светильник, настольную лампу, бра, люстру и встраиваемый в стену светильник; размер моделей стандартный, однако они имеют отделку трех видов: глянцевый алюминий, серый антрацит и окраска под бронзу. Кроме того, помимо готовых моделей можно приобрести светильники на заказ: структура ламп может иметь три различных оттенка, розетки доступны в двух размерах и трех вариантах отделки. Все светильники предназначены для интерьеров. Рассеиватели выполнены из хрустального стекла. Цоколь предназначен для светодиода (LED) и оснащен блоком питания с регулятором яркости.







# MY TRIPLA SYSTEM

Componi e personalizza la tua lampada Tripla  
/ *Compose and customize your Tripla lamp*

## 1. Scelta dei vetri / *Glass options*

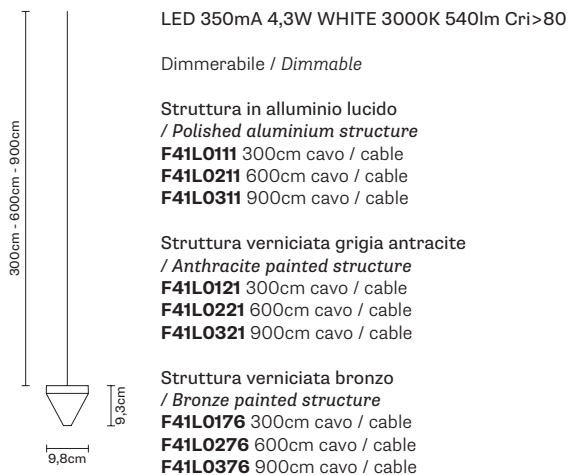

ERC IP55

\* Sono compresi 3 rocchetti di decentramento per codice  
\* *Each code provides 3 spools for wire support*

## 2. Scelta dei rosoni / *Canopies options*

### Rosoni circolari / *Round canopies*

Alimentatore dimmerabile incluso / *Dimmable driver included*

Struttura in alluminio lucido  
/ *Polished aluminium structure*  
**F41M0111** Ø 23,5cm - 350mA (1-3 spots) - Dim. push button 1..10V  
**F41M0311** Ø 30cm - 350mA (4-9 spots) - Dim. push button 1..10V, DALI

Struttura verniciata grigia antracite  
/ *Anthracite painted structure*  
**F41M0121** Ø 23,5cm - 350mA (1-3 spots) - Dim. push button 1..10V  
**F41M0321** Ø 30cm - 350mA (4-9 spots) - Dim. push button 1..10V, DALI

Struttura verniciata bronzo  
/ *Bronze painted structure*  
**F41M0176** Ø 23,5cm - 350mA (1-3 spots) - Dim. push button 1..10V  
**F41M0376** Ø 30cm - 350mA (4-9 spots) - Dim. push button 1..10V, DALI

ERC IP40

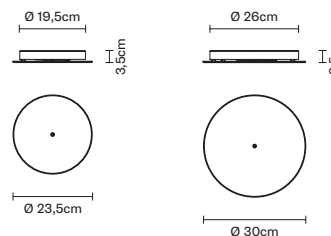

### Rosone a incasso / *Recessed canopy*

Alimentatore remoto escluso / *Remote power supply not included*

**F41Z1001** Ø 3cm - (1 spot)

ERC IP40

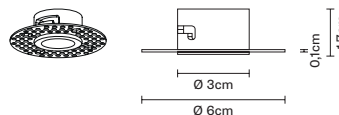

### Box per esterno / *Outdoor box*

Alimentatore incluso / *Driver included*

**F41Z11** 24x19x9cm - (max 10 spot)

ERC IP55

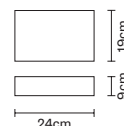

### 3. Accessori disponibili / Available accessories

**F41Z01C100**

Rocchetto di decentramento / *Spool for wire support*

**F41Z0302**

Spezzafilo con interruttore / *Power plug with switch*

### 4. Il sistema / The system

Personalizza la posizione degli spot.  
*Customize spots position.*

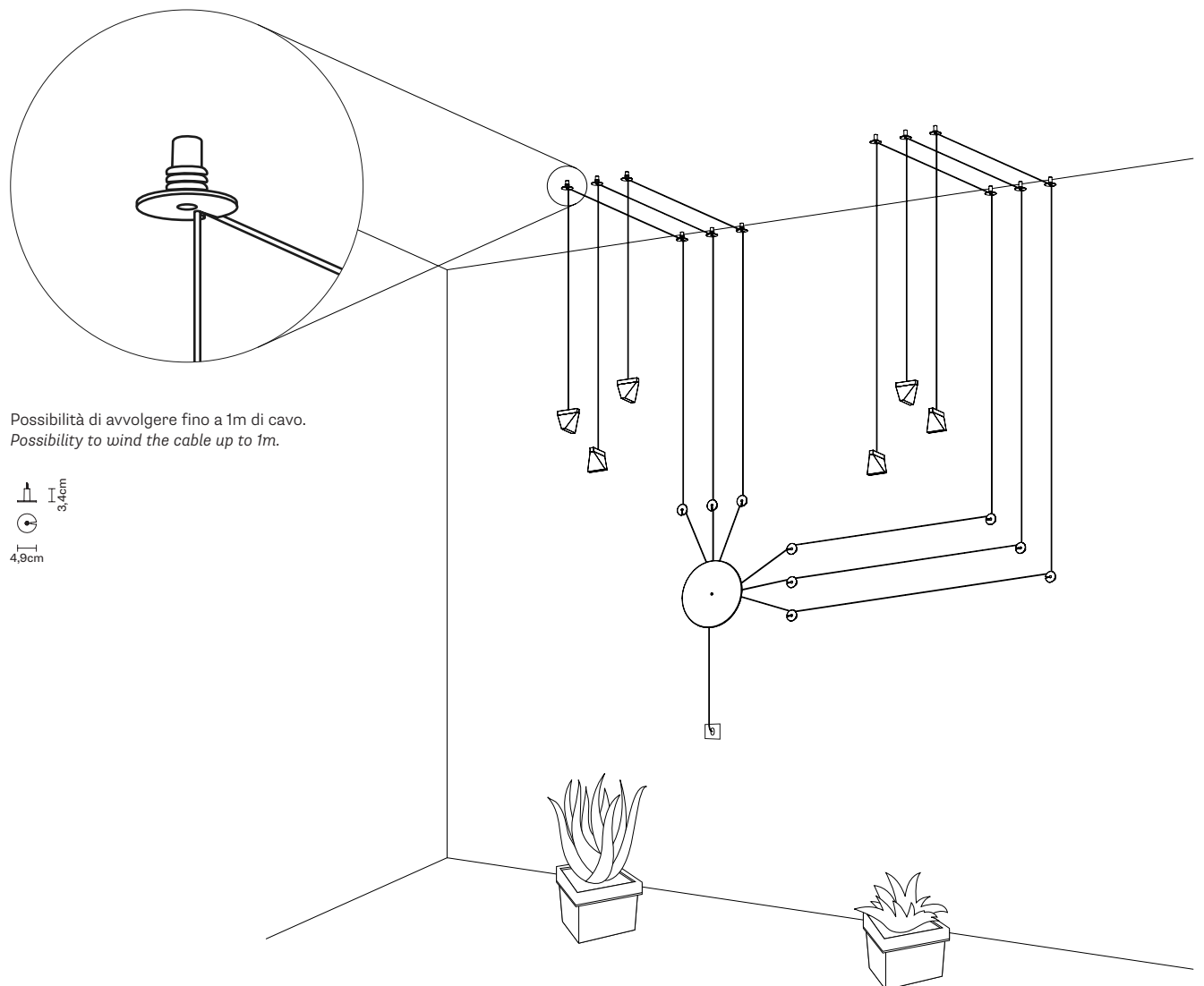



# ROSONE A INCASSO / RECESSED CANOPY

1.

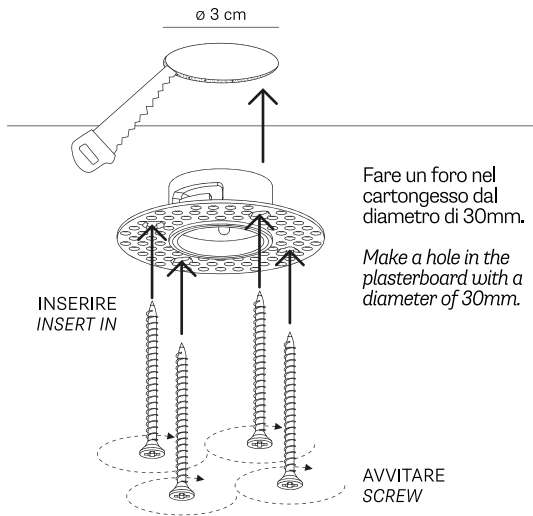

2.

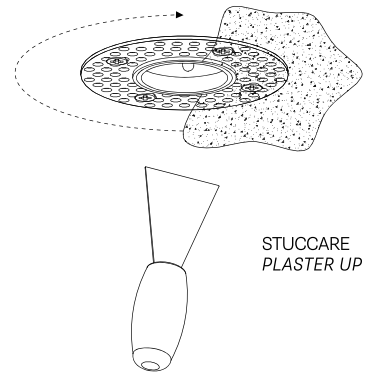

Dopo aver inserito l'accessorio all'interno del foro nel cartongesso, stuccare i bordi.

*After inserting the accessory into the hole in the plasterboard, plaster the edges.*

3.

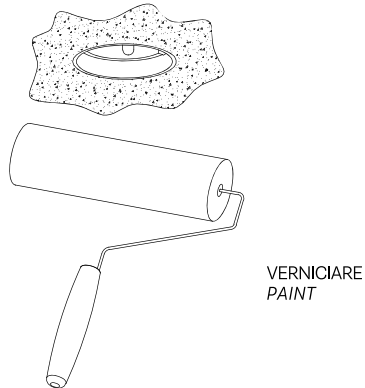

Verniciare l'intera area stuccata in modo da uniformare la finitura del soffitto con l'accessorio.

*Paint the plastered area so that the ceiling finish is homogeneous.*

4.

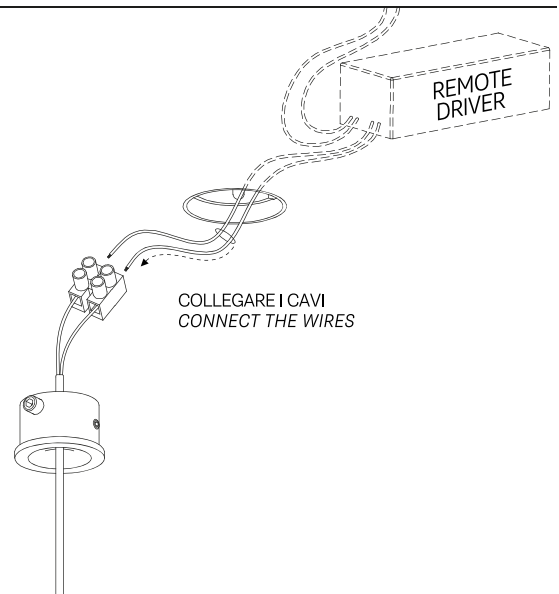

5.

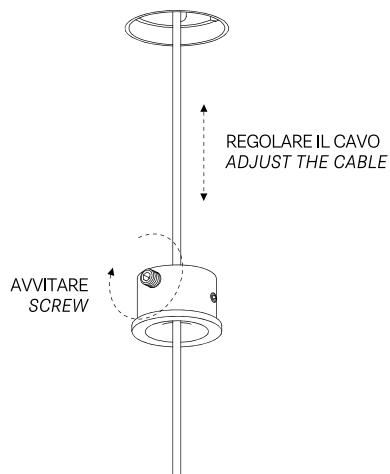

Regolare la lunghezza del cavo e avvitare il grano di plastica.  
*Adjust the length of the cable and screw the plastic thread insert.*

6.

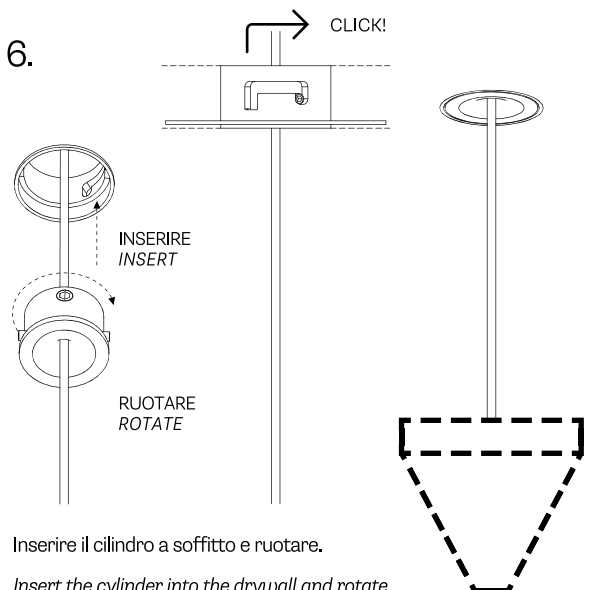

Inserire il cilindro a soffitto e ruotare.  
*Insert the cylinder into the drywall and rotate.*



**UTILITY**

—

## Tipologia / Tipology



**A**  
Lampada a sospensione  
Hanging lamp  
Làmpara de suspensió  
Pendelleuchte  
Suspension  
Подвесной светильник



**B**  
Lampada da tavolo  
Table lamp  
Làmpara de mesa  
Tischleuchte  
Lampe à poser  
Настольный светильник



**C**  
Lampada da pavimento  
Floor lamp  
Làmpara de tierra  
Stehlampe  
Lampadaire  
Напольный светильник



**D**  
Lampada da parete  
Wall lamp  
Appliqué  
Wandleuchte  
Applique  
Настенный светильник



**E**  
Lampada da soffitto  
Ceiling lamp  
Plafon  
Deckenleuchte  
Plafonnier  
Потолочный светильник



**F**  
Faretto da incasso  
Semi-recessed lamp  
Empotrable  
Deckenleuchte mit eingebauter Steckdose  
Spot encastré  
Встроенный светильник



**G**  
Lampada da parete e soffitto  
Wall and ceiling lamp  
Làmpara de techno y pared  
Wand-bzw Deckenleuchte  
Applique ou plafonnier  
Настенно-потолочный светильник



**J**  
Lampada a binario  
Light with track fitting  
Foco para carril  
Schienerstrahler  
Lampe pour rail  
Светильник на шинопровде

## Codici colore / Colour codes

**00**  
Cristallo  
Crystal  
Cristal  
Kristall  
Cristal  
Прозрачный

**01**  
Bianco  
White  
Blanco  
Weiss  
Blanc  
Белый

**02**  
Nero  
Black  
Negro  
Schwarz  
Noir  
Черный

**03**  
Rosso  
Red  
Roho  
Rot  
Rouge  
Красный

**04**  
Giallo  
Yellow  
Amarillo  
Gelb  
Faume  
Желтый

**05**  
Acquamarina  
Aquamarine  
Aigue-marine  
Aguamarina  
Aquamarin  
Аквамарин

**09**  
Avorio  
Ivory  
Marfil  
Elfenbeinfarbe  
Ivoire  
Слоновая кость

**11**  
Alluminio Lucido  
Polished Aluminium  
Aluminio Brillante  
Glänzendaluminium  
Aluminium Poli  
Блестящий алюминий

**12**  
Oro  
Gold  
Oro  
Goldfarben  
Or  
Золотой

**14**  
Brunito satinato  
Satin-finish burnished  
Bruñido satinado  
Matt Braun  
Brun cuivré satiné  
воронение +  
сатинирование

**15**  
Cromo  
Chrome  
Cromo  
Chrom  
Chrome  
Хром

**16**  
Beige  
Beige  
Beige  
Beige  
Beige  
Бежевый

**19**  
Ottonato  
Brass-plated  
Latonado  
Vermessingt  
Cuivré  
Латунированный

**21**  
Grigio Antracite  
Anthracite  
Gris Antracita  
Anthrazitgrau  
Gris Anthracite  
Серый антрацит

**24**  
Cromo nero  
Black chrome  
Cromo negro  
Schwarz Chrom  
Chrome noir  
Черный хром

**27**  
Anodizzato  
Anodized  
Anodizado  
Eloxiert  
Anodisé  
Анодированный

**31**  
Blu  
Blue  
Azul  
Blau  
Bleu  
Синий

**32**  
Arancione  
Orange  
Anaranjado  
Orange  
Orange  
Оранжевый

**34**  
Titanio  
Titanium  
Titanio  
Titanfarbe  
Titane  
Титан

**35**  
Acciaio Inox Lucido  
Polished Stainless Steel  
Inox Poli  
Glänzendinoxstahl  
Acier Inoxidable Brillante  
Блестящая  
нержавеющая сталь

**40**  
Ametista  
Amethyst  
Améthyste  
Amatista  
Amethyst  
Аметист

**41**  
Rame  
Copper  
Cobre  
Kupfer  
Cuivre  
Медь

**43**  
Verde  
Green  
Verde  
Grün  
Vert  
Зеленый

**47**  
Ambra  
Amber  
Ambar  
Berstein  
Ambre  
Янтарный

**48**  
Legno colore scuro  
Dark wood colour  
Madera color oscuro  
Dunkelholz Farbe  
Bois couleur foncée  
Дерево темных тонов

**56**  
Ruggine  
Rust  
Herrumbre  
Rost  
Rouille  
Ржавчина

**60 / 65**  
Bianco 3000K  
White 3000K  
Blanco 3000K  
Weiss 3000K  
Blanc 3000K  
Белый 3000K

**61**  
Alluminio brillantato  
Polished aluminium  
Aluminio abillantado  
Glänzend Alu  
Aluminium brilliant  
полированный  
алюминий

**63**  
Verniciato grigio  
Painted grey  
Pintado gris  
Grau lackiert  
Peint en gris  
серым лаковым  
покрытием

**69**  
Legno colore chiaro  
Light wood colour  
Madera color claro  
Hellholz Farbe  
Bois couleur claire  
Дерево светлых

**71**  
Bianco traslucido  
Translucent white  
Blanco translúcido  
Durchscheinend weiß  
Blanc translucide  
белый Полупрозрачный

**73**  
Blu petrolio  
Teal blue  
Azul petróleo  
Petrolblau  
Bleu pétrole  
Синяя нефть

**74**  
Alluminio dorato  
Gold-plated aluminium  
Aluminio dorado  
Vergoldet Alu  
Aluminium doré  
позолоченный  
алюминий

**75**  
Grigio chiaro  
Light grey  
Gris claro  
Hellgrau  
Gris clair  
Светло-серый

**76**  
Verniciato bronzo  
Bronze painted  
Pintado bronce  
Bronze lackiert  
Peinture bronze  
Лакированная бронза

**99**  
Multicolore  
Multicolour  
Multicolor  
Mehrfarbig  
Multicolore  
Разноцветный



## Informazioni tecniche / Technical information



Systema di inclinazione  
Regolable system  
Systema de inclinación  
Neigungssystem  
Système d'inclinaison  
Система изменения наклона



Vetro temperato  
Tempered glass  
Cristal templado  
Gebrannt Glas  
Verre trempé  
Закаленное стекло

## Classe di isolamento / Class of insulation

Ai fini della protezione elettrica, gli apparecchi sono classificati in base ad indicazioni CEE.

For electric production purposes the fixtures are classified in accordance with EEC guidelines.

Para la protección eléctrica los aparatos se clasifican en base a las indicaciones de la CEE.

Die Geräte sind hinsichtlich der elektrischen Absicherung aufgrund der EWG-Normen klassifiziert.

Concernant la protection électrique, les appareils sont classés selon les indications CEE.

С целью электробезопасности все приборы классифицированы в соответствии с инструкциями CEE.

**Classe I** Isolamento funzionale in ogni parte, provvisto di messa a terra, o con morsetto se fisso o con conduttore e relativa spina con contatto di terra, se mobile.

**Class I** Functional insulation in every part and ground terminal or clamp in the unit is fixed, or with conductor and relative plug with ground contact if the unit is mobile.

**Clase I** Aislamiento funcional en cada parte provista de toma tierra o con pinza fijada, con cable y terminal con contacto de tierra si es móvil.

**Klasse I** Isolierung jedes Bestandteiles mit Erdung, bzw. mit Klemme falls festmontiert oder Drahtleitung und Schuko-Stecker falls beweglich.

**Classe I** Isolement fonctionnel de toutes les composantes, avec mise à la terre ou borne si l'appareil est fixe; avec conducteur et fiche avec contact à la terre si l'appareil est mobile.

**Класс I** Функциональная изоляция в каждой детали, оснащенная заземлением или с помощью зажима для стационарных изделий, или через проводник и соответствующую вилку с контактом в землю для переносных изделий.



**Classe II** Doppio isolamento e/o isolamento rinforzato in ogni parte e senza dispositivo di messa a terra.

**Class II** Double insulation and/or reinforced insulation in every part and without ground devices.

**Clase II** Doble aislamiento Y/O aislamiento reforzado en cada parte i sin toma tierra.

**Klasse II** Doppelte Isolierung, bzw. verstärkte Isolierung der Teile, ohne Vorrichtung für Erdung.

**Classe II** Double isolement et/ou isolement renforcé de toutes les composantes et sans dispositif de mise à la terre.

**Класс II** Двойная изоляция и/или усиленная в каждой детали и без устройства заземления.



**Classe III** Apparecchio in cui la protezione contro la scossa elettrica si basa sull'alimentazione a bassissima tensione di sicurezza e in cui non si producono tensioni superiori alla stessa.

**Class III** Appliance in which protection against electrical shock is guaranteed by the extremely low-voltage power supply and which does not produce higher voltages.

**Clase III** Aparato en el cual la protección contra la descarga eléctrica se debe a la alimentación a muy baja tensión.

**Klasse III** Zum Schutz vor elektrischen Schlägen mit Kleinspannung gespeistes Gerät, in dem keine über dem Speisewert liegende Spannung erzeugt werden.

**Classe III** Appareil avec protection contre les décharges électriques basée sur l'alimentation à une tension de sécurité très basse et sans possibilité de production de tensions supérieures.

**Класс III** Прибор, в котором защита от электрического удара основана на очень низком напряжении и в котором не возникает напряжение, превышающее, указанное.

## Marchi di sicurezza / Safety marks



Apparecchio non adatto al montaggio su superfici normalmente infiammabili.

Appliance unsuitable for mounting on normally flammable surfaces.

Aparato no adecuado para la instalación sobre superficies normalmente inflamables.

Das Gerät ist nicht geeignet für eine Montage auf normal entflammbaren Oberflächen.

Appareil non approprié au montage sur surfaces normalement inflammables.

Прибор, непригодный для установки на воспламеняющихся поверхностях.



Divieto d'uso di lampade a luce fredda.

Warning against the use of cool-beam lamps.

Es desaconsejable el uso de bombillas de luz fría.

Verbot Leuchten mit kaltem Licht zu verwenden.

Défense de utiliser ampoules à lumière froide.

Запрещено использовать лампы холодного света.



Distanza minima dagli oggetti illuminati (metri).

Minimum distance from lighted objects (meters).

Distancia mínima de los objetos alumbrados (metros).

Kleinste Entfernung von den beleuchteten Gegenständen (Meter).

Distance minime des objets éclairés (mètres).

Минимальное расстояние от освещенных предметов (м).



Impiego di cavi di alimentazione, di interconnessione o di cablaggio esterno resistente al calore.

Use of heat resistant supply cables, interconnecting cables or external wiring.

Uso de un cable de alimentación, de interconexión o de cableado exterior resistente al calor.

Verwendung einer äußeren hitzebeständigen Verbindungs- oder Verkabelungs-Speiseleitung.

Utilisation d'un câble d'alimentation d'interconnexion ou de câblage extérieur résistant à la chaleur.

Применение термостойкого кабеля: питающего, соединительного или внешней проводки.

## Certificazioni / Certification



### Gost R EAC

Attesta che il prodotto risulta conforme ai requisiti degli standard russi.

### Gost R EAC

This certifies that the product is in conformity with the requirements laid down by the Russian standards.

### Gost R EAC

Certifica que el producto resulta conforme a los requisitos propuestos por los estándares rusos.

### Gost R EAC

Bescheinigt die Übereinstimmung des Produktes mit den Anforderungen der russischen Standards.

### Gost R EAC

Atteste que le produit est conforme aux conditions essentielles proposées par les standards russes.

### Gost R EAC

Свидетельствует о соответствии продукции российским стандартам



### CSQ

Attesta che la Fabbian S.R.L. società unipersonale attua un sistema qualità conforme alla normativa UNI EN ISO 9001 per garantire la qualità nella progettazione, sviluppo, fabbricazione, commercializzazione, installazione del prodotto.

### CSQ

This certifies that Fabbian S.R.L. società unipersonale implements a quality system in conformity with the standard UNI EN ISO 9001 to ensure quality in design, development, manufacture, selling/marketing and installation of the product.

### CSQ

Atteste que l'entreprise Fabbian S.R.L. société unipersonale a réalisé un système de qualité conforme à la norme UNI EN ISO 9001 afin de garantir la qualité dans la conception, le développement, la fabrication, la commercialisation et l'installation du produit.

### CSQ

Certifica que Fabbian S.R.L. società unipersonale aplica un sistema de calidad conforme a las normas UNI EN ISO 9001 para garantizar la calidad durante el proyecto, desarrollo, fabricación, comercialización e instalación del producto.

### CSQ

Bescheinigt, dass die Firma Fabbian S.R.L. società unipersonale ein Qualitätssystem einsetzt, das für die Gewährleistung der Qualität der Planung, Entwicklung, Herstellung, Vermarktung und Installation des Produktes mit den Vorschriften UNI EN ISO 9001 übereinstimmt.

### CSQ

Свидетельствует, что Fabbian S.R.L. società unipersonale осуществляет систему качества в соответствии с нормативами UNI EN ISO 9001, гарантирующее качество проектирования, разработки, изготовления, продажи, установки изделия.

## Grado di protezione IP / IP protection

Il grado di protezione degli apparecchi di illuminazione viene indicato con la sigla IP (International Protection) seguita da due cifre caratteristiche. La prima di queste due cifre descrive la protezione che questi possiede contro la penetrazione di corpi solidi. La seconda indica la protezione nei confronti dei liquidi.

### Gradi di protezione indicati dalla prima cifra

- 0 Non protetto
- 1 Protetto contro la penetrazione di corpi solidi di dimensioni maggiori a 50 mm
- 2 Protetto contro la penetrazione di corpi solidi di dimensioni maggiori a 12 mm
- 3 Protetto contro la penetrazione di corpi solidi di dimensioni maggiori a 2,5 mm
- 4 Protetto contro la penetrazione di corpi solidi di dimensioni maggiori a 1 mm
- 5 Protetto contro la polvere
- 6 Totalmente protetto contro la polvere

### Gradi di protezione indicati dalla seconda cifra

- 0 Non protetto
- 1 Protetto contro lo stilloidico
- 2 Protetto contro lo stilloidico, con un'inclinazione fino a 15°
- 3 Protetto contro la pioggia
- 4 Protetto contro gli spruzzi d'acqua
- 5 Protetto contro i getti d'acqua
- 6 Protetto contro le onde
- 7 Stagno all'immersione
- 8 Stagno alla sommersione

The protection rating of lighting appliances is shown by the letters IP (international protection) followed by two characteristic digits. The first of these two digits indicates the degree of protection that the appliances offer against the ingress of solid foreign objects. The second indicates the protection against the ingress of water.

### Protection ratings indicated by the first digit

- 0 No protection
- 1 Protected against entry of solid objects larger than 50 mm
- 2 Protected against entry of solid objects larger than 12 mm
- 3 Protected against entry of solid objects larger than 2.5 mm
- 4 Protected against entry of solid objects larger than 1 mm
- 5 Protected against dust
- 6 Completely protected against dust

### Protection ratings indicated by the second digit

- 0 No protection
- 1 Protected against vertically falling drops of water
- 2 Protected against vertically falling drops of water when appliance is tilted up to 15°
- 3 Protected against rain
- 4 Protected against water spray from all directions
- 5 Protected against water jets
- 6 Protected against heavy seas, flooding
- 7 Sealed against immersion up to 1 metre
- 8 Sealed against submersion over 1 metre

El grado de protección de los aparatos de iluminación se indica con la sigla IP (International Protection) seguida por dos dígitos de identificación característicos. La primera cifra indica el grado de protección de los aparatos contra la penetración de los cuerpos sólidos. La segunda cifra indica la protección contra los líquidos.

### Grados de protección comunicados por la primera cifra

- 0 Sin protección
- 1 Protección contra la penetración de cuerpos sólidos de dimensiones superiores a 50 mm
- 2 Protección contra la penetración de cuerpos sólidos de dimensiones superiores a 12 mm
- 3 Protección contra la penetración de cuerpos sólidos de dimensiones superiores a 2,5 mm
- 4 Protección contra la penetración de cuerpos sólidos de dimensiones superiores a 1 mm
- 5 Protección contra el polvo
- 6 Protección total contra el polvo

### Grados de protección comunicados por la segunda cifra

- 0 Sin protección
- 1 Protección contra la caída vertical de gotas de agua
- 2 Protección contra la caída vertical de gotas de agua con una inclinación máxima de 15°
- 3 Protección contra la lluvia
- 4 Protección contra las salpicaduras de agua
- 5 Protección contra los chorros de agua
- 6 Protección contra las olas
- 7 Protección contra los efectos de la inmersión
- 8 Protección contra los efectos de la sumersión

Der Schutzgrad von Beleuchtungsgeräten wird mit der Abkürzung IP (international protection) gefolgt von einer charakteristischen zweistelligen Zahl angegeben. Die erste dieser beiden Ziffern beschreibt den Schutz, den die Beleuchtungsgeräte gegen das Eindringen von Festkörpern besitzen. Die zweite Ziffer gibt den Schutz gegenüber Flüssigkeiten an.

### Von der erstenziffer angegebene schutzgrade

- 0 Nicht geschützt
- 1 Geschützt gegen das Eindringen von Festkörpern mit einer Größe über 50 mm
- 2 Geschützt gegen das Eindringen von Festkörpern mit einer Größe über 12 mm
- 3 Geschützt gegen das Eindringen von Festkörpern mit einer Größe über 2,5 mm
- 4 Geschützt gegen das Eindringen von Festkörpern mit einer Größe über 1 mm
- 5 Gegen Staub geschützt
- 6 Vollständig gegen Staub geschützt

### Von der zweiten ziffer angegebene schutzgrade

- 0 Nicht geschützt
- 1 Geschützt gegen Tropfwasser
- 2 Geschützt gegen Tropfwasser mit einer Neigung bis zu 15°
- 3 Geschützt gegen Regen
- 4 Geschützt gegen Wasserspritzer
- 5 Geschützt gegen Wasserstrahl
- 6 Geschützt gegen Wellen
- 7 Dicht bei zeitweiligem Eintauchen
- 8 Dicht bei dauerndem Untertauchen

Le degré de protection des appareils d'éclairage est indiqué avec le sigle IP (international Protection) suivi par deux chiffres caractéristiques. Le premier de ces deux chiffres décrit la protection que l'appareil possède contre la pénétration de corps solides. Le deuxième chiffre indique la protection vis-à-vis des liquides.

### Degrés de protection indiqués par le premier chiffre

- 0 Non protégé
- 1 Protégé contre la pénétration de corps solides de dimensions supérieures à 50 mm
- 2 Protégé contre la pénétration de corps solides de dimensions supérieures à 12 mm
- 3 Protégé contre la pénétration de corps solides de dimensions supérieures à 2,5 mm
- 4 Protégé contre la pénétration de corps solides de dimensions supérieures à 1 mm
- 5 Protégé contre la poussière
- 6 Totalemant protégé contre la poussière

### Degrés de protection indiqués par le deuxième chiffre

- 0 Non protégé
- 1 Protégé contre les gouttes d'eau
- 2 Protégé contre les gouttes d'eau, avec une inclinaison jusqu'à 15°
- 3 Protégé contre la pluie
- 4 Protégé contre les éclaboussures d'eau
- 5 Protégé contre les jets d'eau
- 6 Protégé contre les ondes
- 7 Étanche à l'immersion
- 8 Étanche à la submersion

Степень защиты осветительных приборов обозначена буквами IP (international protection) и двумя цифрами. Первая цифра указывает степень защиты от проникновения твердых частиц. Вторая цифра указывает степень защиты от проникновения жидкостей.

- 0 Не защищен
- 1 Защищен от проникновения твердых частиц диаметром больше 50 мм
- 2 Защищен от проникновения твердых частиц диаметром больше 12 мм
- 3 Защищен от проникновения твердых частиц диаметром больше 2,5 мм
- 4 Защищен от проникновения твердых частиц диаметром больше 1 мм
- 5 Защищен от пыли
- 6 Полностью защищен от пыли

- 0 Не защищен
- 1 Защищен от просачивания
- 2 Защищен от просачивания с наклоном до 15°
- 3 Защищен от дождя
- 4 Защищен от водяных брызг
- 5 Защищен от водяных струй
- 6 Защищен от волн
- 7 Водонепроницаем при погружении
- 8 Водонепроницаем при затоплении

## IP20

Protetto contro la penetrazione di corpi solidi di dimensioni maggiori a 12 mm. Non protetto nei confronti dei liquidi.

Protected against entry of solid objects larger than 12 mm. No protection against the ingress of water.

Protección contra la penetración de cuerpos sólidos de dimensiones superiores a 12 mm. Sin protección contra los líquidos.

Flüssigkeiten an Geschützt gegen das Eindringen von Festkörpern mit einer Größe über 12 mm. Nicht geschützt Schutz gegenüber.

Protégé contre la pénétration de corps solides de dimensions supérieures à 12 mm. Non protégé vis-à-vis des liquides.

Защищен от проникновения твердых частиц диаметром больше 12 мм. Не защищен от водяных брызг.

## IP21

Protetto contro la penetrazione di corpi solidi di dimensioni maggiori a 12 mm. Protetto contro lo stilloidico.

Protected against entry of solid objects larger than 12 mm. Protected against vertically falling drops of water.

Protección contra la penetración de cuerpos sólidos de dimensiones superiores a 12 mm. Protección contra la caída vertical de gotas de agua.

Geschützt gegen das Eindringen von Festkörpern mit einer Größe über 12mm. Geschützt gegen Tropfwasser.

Protégé contre la pénétration de corps solides de dimensions supérieures à 12mm. Protégé contre les gouttes d'eau.

Защищен от проникновения твердых частиц диаметром больше 12 мм. Защищен от просачивания.

## IP40

Protetto contro la penetrazione di corpi solidi di dimensioni maggiori a 1 mm. Non protetto nei confronti dei liquidi.

Protected against entry of solid objects larger than 1 mm. No protection against the ingress of water.

Protección contra la penetración de cuerpos sólidos de dimensiones superiores a 1 mm. Sin protección contra los líquidos.

Geschützt gegen das Eindringen von Festkörpern mit einer Größe über 1 mm. Nicht geschützt Schutz gegenüber.

Protégé contre la pénétration de corps solides de dimensions supérieures à 1 mm. Non protégé contre les éclaboussures.

Защищен от проникновения твердых тел размером более 1 мм. Не защищен от водяных брызг.

## IP41

Protetto contro la penetrazione di corpi solidi di dimensioni maggiori a 1 mm. Protetto contro lo stilloidico.

Protected against entry of solid objects larger than 1 mm. Protected against vertically falling drops of water.

Protección contra la penetración de cuerpos sólidos de dimensiones superiores a 1 mm. Protección contra la caída vertical de gotas de agua.

Geschützt gegen das Eindringen von Festkörpern mit einer Größe über 1 mm. Geschützt gegen Tropfwasser.

Protégé contre la pénétration de corps solides de dimensions supérieures à 1 mm. Protégé contre les gouttes d'eau.

Защищен от проникновения твердых частиц диаметром больше 1 мм. Защищен от просачивания.

## IP44

Protetto contro la penetrazione di corpi solidi di dimensioni maggiori a 1 mm. Protetto contro gli spruzzi d'acqua.

Protected against entry of solid objects larger than 1 mm. Protected against water spray from.

Protección contra la penetración de cuerpos sólidos de dimensiones superiores a 1 mm. Protección contra las salpicaduras de agua.

Geschützt gegen das Eindringen von Festkörpern mit einer Größe über 1 mm. Geschützt gegen Wasserspritzer.

Protégé contre la pénétration de corps solides de dimensions supérieures à 1 mm. Protégé contre les éclaboussures.

Защищен от проникновения твердых тел размером больше 1 мм. Защищен от водяных брызг.

## IP65

Totalmente protetto contro la polvere. Protetto contro i getti d'acqua.

Completely protected against dust. Protected against water jets.

Protección total contra el polvo. Protección contra los chorros de agua.

Vollständig gegen Staub geschützt. Geschützt gegen Wasserstrahl.

Totalemant protégé contre la poussière. Protégé contre les jets d'eau.

Полностью защищен от пыли. Защищен от водяных струй.

## IP67

Totalmente protetto contro la polvere. Stagno all'immersione.

Completely protected against dust. Sealed against immersion up to 1 metre.

Protección total contra el polvo. Protección contra los efectos de la inmersión.

Vollständig gegen Staub geschützt. Dicht bei zeitweiligem Eintauchen.

Totalemant protégé contre la poussière. Étanche à l'immersion.

Полностью защищен от пыли. Водонепроницаем при погружении.

## Grado di protezione e classe di isolamento per locali bagni / IP protection and class insulation for bathroom

Normativa CEI 64-8/7

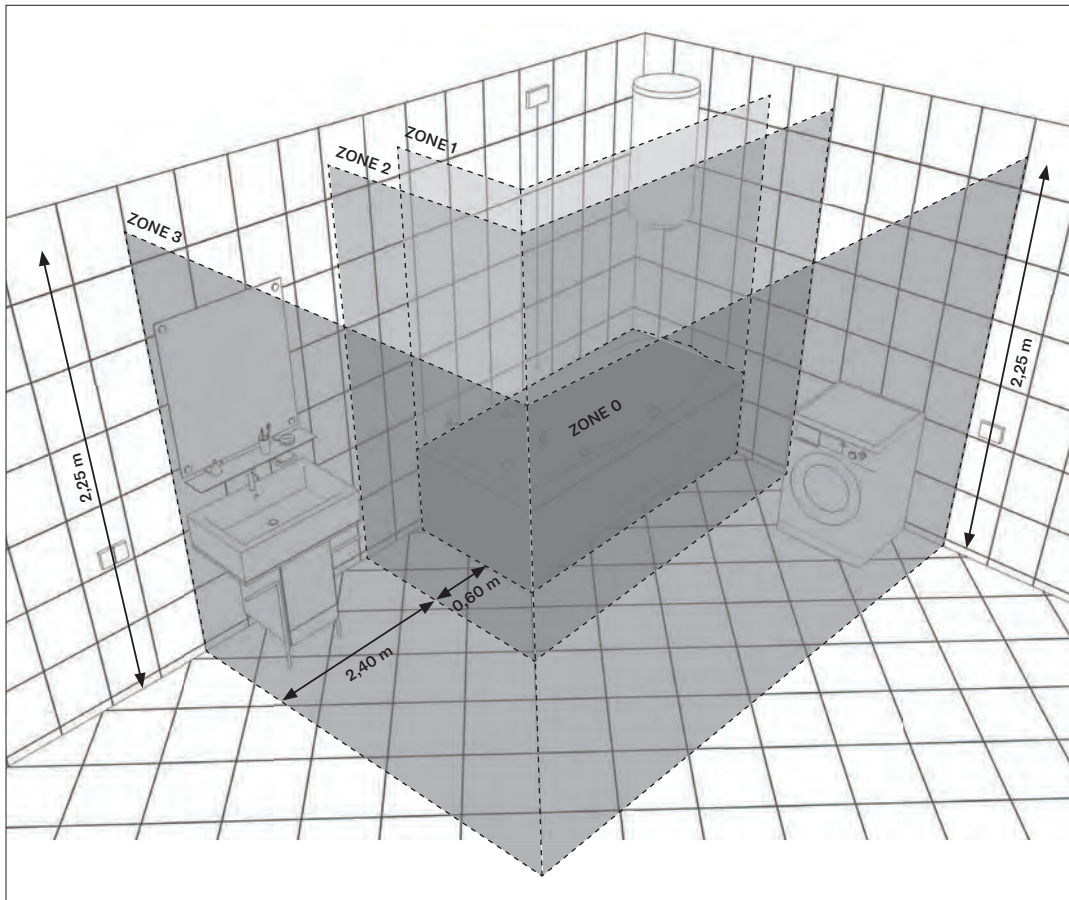

### Zona 1

Grado di protezione IPX4 (non inferiore a IPX5 nei bagni pubblici o di comunità quando è previsto l'uso di getti d'acqua per la pulizia).  
Classe di isolamento degli apparecchi illuminanti III.

Degree of protection IPX4 (not below IPX5 in public or community bathrooms when water jets are envisaged for cleaning).  
Lighting insulation class III.

Grado de protección IPX4 (no inferior a IPX5 en los baños públicos o de comunidad cuando está previsto el uso de chorros de agua para la limpieza).  
Clase de aislamiento de los aparatos iluminados III.

Schutzart IPX4 (nicht unter IPX5 in öffentlichen Toiletten oder Gemeinschaftstoiletten, bei Reinigung mit Strahlwasser).  
Isolierklasse der Leuchten III.

Degré de protection IPX4 (non inférieur à IPX5 dans les toilettes publiques ou communes lorsque l'utilisation de jets d'eau pour le nettoyage est prévue).  
Classe d'isolation des appareils d'éclairage III.

Степень защиты IPX4 (не ниже IPX5 в общественных туалетах, если уборка предусматривает полив водой из шланга).  
Класс изоляции осветительных приборов III.

### Zona 2

Grado di protezione IPX4 (non inferiore a IPX5 nei bagni pubblici o di comunità quando è previsto l'uso di getti d'acqua per la pulizia).  
Classe di isolamento degli apparecchi illuminanti II, III e I purché protetto da interruttore differenziale da 30 mA.

Degree of protection IPX4 (not below IPX5 in public or community bathrooms when water jets are envisaged for cleaning).  
Lighting insulation class II, III and I as long as protected by 30 mA residual current circuit breaker.

Grado de protección IPX4 (no inferior a IPX5 en los baños públicos o de comunidad cuando está previsto el uso de chorros de agua para la limpieza).  
Clase de aislamiento de los aparatos iluminados II, III y I a condition que esté protegido por un interruptor diferencial de 30mA.

Schutzart IPX4 (nicht unter IPX5 in öffentlichen Toiletten oder Gemeinschaftstoiletten, bei Reinigung mit Strahlwasser).  
Isolierklasse der Leuchten II, III und I nur, wenn sie durch einen Differenzialschalter von 30mA geschützt sind.

Degré de protection IPX4 (non inférieur à IPX5 dans les toilettes publiques ou communes lorsque l'utilisation de jets d'eau pour le nettoyage est prévue).  
Classe d'isolation des appareils d'éclairage II, III et I à condition qu'elle soit protégée par un interrupteur différentiel de 30 mA.

Степень защиты IPX4 (не ниже IPX5 в общественных туалетах, если уборка предусматривает полив водой из шланга).  
Класс изоляции осветительных приборов II и III, даже I – если прибор защищен дифференцированным переключателем на 30 mA.

### Zona 3

Grado di protezione IPX1 (non inferiore a IPX5 nei bagni pubblici o di comunità quando è previsto l'uso di getti d'acqua per la pulizia).  
Classe di isolamento degli apparecchi illuminanti I, II, III.

Degree of protection IPX1 (not below IPX5 in public or community bathrooms when water jets are envisaged for cleaning).  
Lighting insulation class I, II, III.

Grado de protección IPX1 (no inferior a IPX5 en los baños públicos o de comunidad cuando está previsto el uso de chorros de agua para la limpieza).  
Clase de aislamiento de los aparatos de iluminación I, II, III.

Schutzart IPX1 (nicht unter IPX5 in öffentlichen Toiletten oder Gemeinschaftstoiletten, bei Reinigung mit Strahlwasser).  
Isolierklasse der Leuchten I, II, III.

Degré de protection IPX1 (non inférieur à IPX5 dans les toilettes publiques ou communes lorsque l'utilisation de jets d'eau pour le nettoyage est prévue).  
Classe d'isolation des appareils d'éclairage I, II et III.

Степень защиты IPX1 (не ниже IPX5 в общественных туалетах, если уборка предусматривает полив водой из шланга).  
Класс изоляции осветительных приборов I, II и III.

## Alimentatori, trasformatori, driver, dimmer / Ballasts, transformers, drivers, dimmers

Codice / Code	Descrizione / Description	N. lamp. / N. bulbs	Applicazioni / Applications						
			D14	D27	D67	F18	F19	F32	F39
<b>Alimentatore elettronico / Electronic power supply</b>									
A32101	Alimentatore elettronico per lampade a fluorescenza 18W TC-D/E TC-T/E Electronic power supply for fluorescence lamps 18W TC-D/E & TC-T/E	max 1	F39						
A40202	Alimentatore elettronico per lampade 70W a ioduri metallici Electronic ballast for metal halide lamps 70W	max 1			L38				
<b>Trasformatori elettronici dimmerabili / Dimmable electronic transformers</b>									
A22101	Trasformatore elettronico 60W 230/12V (min 10W-max 60W) Electronic transformer 60W 230/12V (min 10W-max 60W)	max 1	F02 F04 F06 F08	F10 F12 F14 F16	F18 F29 F52 F57	F62	F02 F05 F11 F21	F24 F31 F41	
A22102	Trasformatore elettronico 100W 230/12V (min 35W-max 100W) Electronic transformer 100W 230/12V (min 35W-max 100W)	max 1				L37	F50 F60		
		max 2	F02 F04 F06 F08	F10 F12 F14 F16	F18 F29 F52 F57	F62	F02 F05 F11 F21	F24 F31 F41	
A22201	Trasformatore elettronico 150W 230/12V (min 75W-max 150W) Electronic transformer 150W 230/12V (min 75W-max 150W)	max 1				L37			
		min 2 max 3	F02 F04 F06 F08	F10 F12 F14 F16	F18 F29 F52 F57	F62	F02 F05 F11 F21	F24 F31 F41	
		max 2					L37	F50 F60	
A22202	Trasformatore elettronico 200W 230/12V (min 100W-max 200W) Electronic transformer 200W 230/12V (min 100W-max 200W)	max 2					F50 F60		
		min 2 max 4	F02 F04 F06 F08	F10 F12 F14 F16	F18 F29 F52 F57	F62	F02 F05 F11 F21	F24 F31 F41	
<b>Trasformatori elettronici dimmerabili per lampadine a LED / Dimmable electronic transformers for LED bulbs</b>									
A22105	Trasformatore elettronico 70W 230/12V (min 1W-max 70W) Electronic transformer 70W 230/12V (min 1W-max 70W)	max 1	F02 F04 F06 F08	F10 F12 F14 F16	F18 F29 F52 F57	F62	F02 F05 F11 F21	F24 F31 F41	
		max 1						F50 F60	
<b>Driver elettronici / Electronic drivers</b>									
A50307	Driver elettronico dimmerabile multitemperatura/multicorrente 20W 24Vdc Dimmable electronic driver multi-voltage/multi-current 20W 24Vdc	max 1					F01 F02		
	Driver elettronico dimmerabile multitemperatura/multicorrente 25W 700mA Dimmable electronic driver multi-voltage/multi-current 25W 700mA	max 10						L01 L02 L03 L51	L08 L11 L12 L13 L61 L62 L63
A22005	Driver elettronico 30W 24Vdc Electronic driver 30W 24Vdc	max 2					F01 F02		
<b>Alimentatori per strip LED / Ballasts for LED strips</b>									
A50207	Alimentatore a tensione costante 35W 24Vdc LED power supply constant voltage 35W 24Vdc	max 1							G01
A50208	Alimentatore a tensione costante 60W 24Vdc LED power supply constant voltage 60W 24Vdc	max 1							G03
A50209	Alimentatore a tensione costante 100W 24Vdc LED power supply constant voltage 100W 24Vdc	max 1							G05
<b>Dimmer per piantana / Floor lamp dimmer</b>									
A60101	Dimmer elettronico max 300W Electronic dimmer max 300W	max 1	C01 C11	D57 C01	D75	F07 C07 C09 C05 C08	F23 C01 C05 C02 C08	F27 C01 C03	

## Casseforme per calcestruzzo / Wallboxes for concrete

Codice / Code	Descrizione / Description	N. lamp. / N. bulbs	Applicazioni / Applications
A70408	Cassaforma per faretti a tensione di rete Wallbox for mains voltage spots	max 1	D27
A70409	Cassaforma per faretti a bassa tensione e LED Wallbox for low-voltage spots and LED	max 1	D27 D60

## Alimentatori per Laminis e Tile / LED power for Laminis and Tile

Codice / Code	Descrizione / Description	N. lamp. / N. bulbs
A50202	Alimentatore a tensione costante 20W 24Vdc, dimmerabile 1.10V / LED power supply constant voltage 20W 24 Vdc, dimmable 1.10V	max 30cm
A50203	Alimentatore a tensione costante 25W 24Vdc, dimmerabile 1.10V / LED power supply constant voltage 25W 24 Vdc, dimmable 1.10V	max 60cm
A50204	Alimentatore a tensione costante 40W 24Vdc, dimmerabile 1.10V / LED power supply constant voltage 40W 24 Vdc, dimmable 1.10V	max 120cm
A50205	Alimentatore a tensione costante 60W 24Vdc, dimmerabile 1.10V / LED power supply constant voltage 60W 24 Vdc, dimmable 1.10V	max 210cm
A50206	Alimentatore a tensione costante 90W 24Vdc, dimmerabile 1.10V / LED power supply constant voltage 90W 24 Vdc, dimmable 1.10V	max 300cm
A50308	Kit per controllo Dali (4 canali d'uscita) e Push / Dali (4 output channel) and Push kit control	max 300cm





















## Convertitori per LED di potenza / Drivers for brightness LEDs

Codice / Code	Descrizione / Description	N. lamp. / N. bulbs	Applicazioni / Applications								
			D14	D27	D60	F19	F32	F40	F41		
A50101	Convertitore per LED di potenza da 350mA (max 15W) Converter for high brightness LEDs 350mA (max 15W)	max 1				F03 F08 F22 F25					
A50103	Convertitore per LED di potenza da 700mA (min 9W-max 27W) Converter for high brightness LEDs 700mA (min 9W-max 27W)	max 2	F54 F56	F31 F33 F35 F37 F39	F40 F43 F44 F47 F49	F54 F59 F64					
A50106	Convertitore per LED di potenza da 500mA (max 20W) Converter for high brightness LEDs 500mA (max 20W)	max 1				F53 F54 F63					
A50107	Convertitore dimmerabile per LED di potenza da 500/700mA (max 20W) push 1.10V Dimmable converter for high brightness LEDs 500/700mA (max 20W) push 1.10V	max 1	F54 F56	F31 F33 F35 F37 F39	F40 F43 F44 F47 F49	F54 F59 F64	F15 F16 F19 F20				
A50108	Convertitore per LED di potenza da 500mA (max 12W) Converter for LEDs 500 mA (max 12W)	max 1				F15 F16 F19 F20					
A50109	Convertitore per LED di potenza da 700mA (max 17W) Converter for LEDs 700 mA (max 17W)	max 1		F31 F33 F35 F37 F39	F40 F43 F44 F47 F49	F54 F59 F64					
A50110	Convertitore per Multispot di potenza da 500mA/12V (6W) Converter for Multispot 500mA/12V (6W)	max 1					L01 L02 L03 L04	L51 L52 L53 L54	L06 L07 L08 L09	L11 L12 L13 L14	L61 L62 L63 L64
A50111	Convertitore dimmerabile per LED di potenza da 350mA (6W) push 1.10V Dimmable converter for high brightness LEDs 350mA (6W) push 1.10V	max 1									L01 L02 L03
A50112	Convertitore dimmerabile per LED di potenza da 700mA (18W) Dimmable converter for high brightness LEDs 700mA (18W)	max 1							F01 F03	F09 F11	
A50113	Convertitore dimmerabile per LED di potenza da 500mA (25W) Dimmable converter for high brightness LEDs 500mA (25W)	max 1							F17 F19	F21 F23	
A50114	Convertitore dimmerabile per LED di potenza da 700mA (36W) Dimmable converter for high brightness LEDs 700mA (36W)	max 1							F25 F27	F29 F31	
A50115	Convertitore dimmerabile per LED con cambio di temperatura colore di potenza da 350mA (15W) Dimmable converter for high brightness LEDs with colour tuning 350mA (15W)	max 1							F05 F07	F13 F15	



















## Accessori a binario / Track accessories

Immagine del prodotto / Still life	Descrizione / Description	Codice / Code	Colore / Colour	Informazioni / Item information	Applicazioni / Applications
	Binario monofase a 3 accensioni Single phase 3 circuits tracks 230V - 16A	A60201 01 A60201 02 A60201 27	bianco / white nero / black grigio / grey	Soffitto / Ceiling 100cm	D57 J
		A60202 01 A60202 02 A60202 27	bianco / white nero / black grigio / grey	Soffitto / Ceiling 200cm	D57 J
		A60203 01 A60203 02 A60203 27	bianco / white nero / black grigio / grey	Soffitto / Ceiling 300cm	D57 J
	Binario monofase a 3 accensioni Single phase 3 circuits tracks 230V - 16A	A60204 01 A60204 02 A60204 27	bianco / white nero / black grigio / grey	Controsoffitto / Counter ceiling 100cm	D57 J
		A60205 01 A60205 02 A60205 27	bianco / white nero / black grigio / grey	Controsoffitto / Counter ceiling 200cm	D57 J
		A60206 01 A60206 02 A60206 27	bianco / white nero / black grigio / grey	Controsoffitto / Counter ceiling 300cm	D57 J
	Congiunzione Straight connector	A60207 01 A60207 02 A60207 27	bianco / white nero / black grigio / grey	Congiunzione Straight connector	D57 J
	Congiunzione Connector	A60208 01 A60208 02 A60208 27	bianco / white nero / black grigio / grey	Giunto flessibile per soffitto Connector flexible for ceiling	D57 J
	Congiunzione Connector	A60209 01 A60209 02 A60209 27	bianco / white nero / black grigio / grey	Giunto 90° per controsoffitto Connector 90° for counter ceiling	D57 J
	Alimentazione Feeder	A60210 01 A60210 02 A60210 27	bianco / white nero / black grigio / grey	Alimentazione DX con testata di chiusura Feeder DX with head end	D57 J
		A60211 01 A60211 02 A60211 27	bianco / white nero / black grigio / grey	Alimentazione SX con testata di chiusura Feeder SX with head end	D57 J

## Indice lampadine / Bulbs index

Lampadine / Bulbs	Descrizione / Description	Codice / Code	Q.tà / Qty (nr)	Potenza / Power (W)	Tensione / Volt (V)	Attacco / Socket	Fascio luce / Light beam	Flusso luce / Light flux (lumen)	Intensità luminosa / Lighting power (cd)	Temp. colore / Light temp. (Kelvin)	Codice ILCOS L / Code ILCOS L	Tipo / Type
<b>Lampadine alogene / Halogen bulbs</b>												
	sfera chiara clear sphere	A10101C10	10	30	230	E14		405		2700	HSGSB	P45
		A10102C10	10	46								
		A10113C10	10	20								
	sfera chiara clear sphere	A10202C10	10	46	230	E27		700		2700	HSGSA	A60
		A10221C10	10	57								
		A10222C10	10	77								
	lampadina con riflettore bulb with reflector	A10220C01	1	75	230	E27	12°		7200	2800	HSGS	PAR38
	alogena halogen	A10205C15	15	100	230	E27	30°		3500	2900	HAGS/UB	PAR30
	alogena chiara clear halogen	A10207C12	12	100	230	E27		1800		2900	HSGST	QT-32
		A10208C12	12	150								
		A10209C12	12	205								
	alogena chiara clear halogen	A11001C20	20	20	230	G9		235		2700	HSGST	Halopin Bipin Hipin
		A11002C20	20	33								
		A11003C20	20	48								
		A11004C20	20	60								
	alogena halogen	A10301C10	10	10	12	G4		130		2800	HSGS	QT-9
		A10302C10	10	20								
		A10306C10	10	5								
	alogena (118 mm) halogen (118 mm)	A11505C20	20	120	230	R7s		2250		2900	HDG	QT-DE12
		A11506C20	20	160								
		A11507C20	20	230								
	alogena (78 mm) halogen (78 mm)	A11501C20	20	48	230	R7s		750		2900	HDG	QT-DE12
		A11502C20	20	80								
		A11503C20	20	120								
	alogena dicroica dichroic halogen	A10401C10	10	20	12	GU4	36°	205	580	3000	HRGS	
		A10402C10	10	35								
	alogena alluminizzata aluminized halogen	A11101C20	20	50	230	GU10	25°	350	1500	2900	HAGS/UB	Ø64mm Ø51mm
		A11102C20	20	50								
		A11103C20	20	75								
	alogena alluminizzata aluminized halogen	A10701C10	10	50	12	GU5,3	36°	675	1500	2900	HAGS/UB	
	alogena dicroica dichroic halogen	A10703C10	10	50	12	GU5,3	10°	870	15000	3000	HRGS	
		A10702C10	10	20								
		A10704C10	10	50								
	alogena alluminizzata aluminized halogen	A10601C06	6	50	12	G53	24°	510	4000	2900	HAGS/UB	
		A10602C06	6	100								
	alogenuri metal halide	A12701C01	1	35	230	GX8,5	40°	3300	4000	3000	MR	PAR30
		A12702C01	1	70								
	alogenuri metal halide	A111302C01	1	70	230	G12		7300		3000	MT	
<b>Strip, barre lineari e lenti per LED / LED strips, linear bars and lens</b>												
	strip LED (5 metri, IP20) LED strips (5 metres, IP20)	A50504	1	115	24			2600/m		3000		
	strip LED (5 metri, IP65) LED strips (5 metres, IP65)	A50505	1	115	24			2600/m		3000		
	Profilo in alluminio con lente 30°, clips e tappi (2 metri) Aluminium bar with lens 30°, clips and caps (2 meters)	A50602	1									
	Profilo in alluminio con diffusore, clips e tappi (2 metri) Aluminium bar with diffusor, clips and caps (2 meters)	A50603	1									

**Indice lampadine**  
**/ Bulbs index**

Lampadine / Bulbs	Descrizione / Description	Codice / Code	Q.tà / Qty (nr)	Potenza / Power (W)	Tensione / Volt (V)	Attacco / Socket	Fascio luce / Light beam	Flusso luce / Light flux (lumen)	Intensità luminosa / Lighting power (cd)	Temp. colore / Light temp. (Kelvin)	Codice ILCOS L / Code ILCOS L	Tipo / Type
<b>Lampadine fluorescenti / Fluorescent bulbs</b>												
	sfera fluorescente fluorescent sphere	A10223C10	10	9	230	E27		430		2700	FBG	P45
	sfera fluorescente fluorescent sphere	A10105C10	10	6	230	E14		235		2700	FBC	P45
	sfera fluorescente fluorescent sphere	A10211C10 A10212C10	10 10	11 15	230	E27		550 820		2700	FBG	A60
	sfera fluorescente fluorescent sphere	A10229C01	1	23	230	E27		1371		2700	FBC	
	fluorescenza elettronica fluorescent electronic	A10214C10 A10215C10 A10216C10 A10217C10 A10218C10	10 10 10 10 10	11 14 18 22 30	230	E27		620 820 1140 1440 2000		2700	FBT	Energy saving
	fluorescenza compatta compact fluorescent	A10106C10	10	12	230	E14		650		2700	FBT	
	fluorescenza compatta compact fluorescent	A10210C10	10	12	230	E27		650		2700	FBT	
	fluorescenza compatta compact fluorescent	A11801C10 A12001C10	10 10	18 26	230	G24d-2 G24q-3		1200 1800		3000	FSD	TC-D
	fluorescenza compatta compact fluorescent	A12201C10	10	18	230	GX24q-2		1200		3000	FSQ	TC-T
<b>LED / LEDs</b>												
	led dimmerabile dimnable leds	A10111C01	1	6	230	E14		470		2700		P45 CL
	led dimmerabile dimnable leds	A10225C01	1	10	230	E27		1055		2700		A60
	led dimmerabile dimnable leds	A10227C01	1	14	230	E27	30°	1080	2500	2700		PAR38
	led dimmerabile dimnable leds	A10228C01	1	9	230	E27	30°	860	1800	2700		PAR30
	led leds	A10307C01	1	2	12	G4		210		3000		
	led leds	A10230C01	1	7,5	230	E27		1050		2700		
	led leds	A10705C01	1	5	12	GU5,3	36°	350	950	3000		MR16
	led dimmerabile dimnable leds	A10603C01	1	15,5	12	G53	24°	960	3100	2700		ARIII
	led dimmerabile dimnable leds	A11105C01	1	7,2	230	GU10	36°	575	1439	3000		MR16

Note  
/ Notes



Note  
/ Notes

**Photography**

Alberto Parise  
Alessandro Astegiano  
Christian van der Kooy  
Claudio Carraro  
Garrett Rowland  
Giulio Favotto  
Luc Boegly  
Luca Morandini  
Nava-Rapacchietta  
Phase One Photography  
Quasar  
Studio Rublek

**Press and print**

La Tipografica

All texts are set in Supria designed  
by Hannes Von Döhren in 2011

Printed on Magno Volume paper

This catalogue cannot be copied,  
scanned or reproduced by any means.  
All rights reserved. Pictures,  
descriptions, quoting, dimensions and  
technical datas have to be considered  
as purely indicative.

While maintaining the basic  
characteristic of the product, the  
manufacturer reserves the right to  
make modifications at any time with  
the sole aim of improvement.

IP Cat/Mkt/03175000

